



**Raytheon**

## **AWIPS System Manager's Manual: AWIPS II Operational Build 16.2.2**

Document No. AWP.MAN.SMM.A2-OB16.2.2-01.00

31 August 2016

Prepared Under

Contract DG133W-05-CQ-1067  
Advanced Weather Interactive Processing System (AWIPS)  
Operations and Maintenance

Submitted to:

Mr. Beraq Azeem  
Contracting Officer's Technical Representative  
U.S. Department of Commerce  
NOAA/NWS Office of Central Processing  
SSMC2, Room 15130  
1325 East-West Highway  
Silver Spring, MD 20910

By:

**Raytheon**

Raytheon Technical Services Company LLC  
8401 Colesville Road, Suite 800  
Silver Spring, MD 20910

# **Chapter 1**

## **Introduction**

## Chapter 1: Introduction

### Table of Contents

	<i>Page</i>
1.1 Scope.....	1
1.2 Intended Audience .....	1
1.3 Organization of the Manual .....	1

The *AWIPS System Manager's Manual (SMM)* provides information for use in managing the Advanced Weather Interactive Processing System (AWIPS) at a site level. System management includes controlling user access, supporting user functions, and some file and database maintenance. Each area of responsibility requires knowledge of and the ability to use AWIPS components.

The operations and maintenance of AWIPS is being performed by Raytheon under U.S. Department of Commerce, National Oceanic and Atmospheric Administration (NOAA) Contract DG133W-05-CQ-1067.

If you find errors in the manual, please write to the AWIPS Documentation Team at [nws.hq.awips.doc.team@noaa.gov](mailto:nws.hq.awips.doc.team@noaa.gov).

## **1.1 Scope**

This manual is designed to serve as a guide for the management of Operational AWIPS.

As new AWIPS II releases are implemented, the SMM will continue to be updated to capture additional or changed functionality.

## **1.2 Intended Audience**

This manual is intended for use by AWIPS system managers. Users are assumed to have a basic understanding of, and some experience using, UNIX, Linux, Postgres, SQL, Java, and Python.

## **1.3 Organization of the Manual**

The *AWIPS System Manager's Manual* provides a detailed description of the system and its associated environments tailored for AWIPS system managers. It is organized into the following chapters and appendices:

Chapter 1	Introduction
Chapter 2	AWIPS System Architecture
Chapter 3	Individual User Accounts
Chapter 4	Data Flow Overview
Chapter 5	Ingest of Satellite Imagery
Chapter 6	Ingest of NWSTG Data
Chapter 7	Ingest of Radar Data
Chapter 8	Local Data Acquisition and Dissemination (LDAD) System
Chapter 9	Background Applications
Chapter 10	Asynchronous Product Scheduler
Chapter 11	Crons and Purging
Chapter 12	Database Management
Chapter 13	Event Notification
Chapter 14	Message Handling System

Chapter 15	Localization
Chapter 16	Customization
Chapter 17	AWIPS System Monitor
Chapter 18	Failover Management Procedures
Chapter 19	System Backup and Recovery Procedures
Chapter 20	System Console
Chapter 21	System Shutdown and Startup Procedures
Chapter 22	Maintenance Management Procedures
Chapter 23	NCF Archive
Chapter 24	Data Archive Server
Chapter 25	AWIPS II/EDEX Administration Guide
Chapter 26	Thin Client
Chapter 27	Collaboration
Chapter 28	WES-2Bridge
Chapter 29	Data Delivery System Administrator's Guide
Chapter 30	User Administration
Chapter 31	Product Generation
Chapter 32	Broadcast Message Handler
Appendix A	Abbreviations and Acronyms
Appendix B	Decoding and Storage Data Flow Exhibits
Appendix C	Directories for /awips2/edex/data and /data/fxa
Appendix D	Glossary
Appendix E	Mass Storage Design
Appendix F	NWS/AWIPS Security Policy
Appendix G	AWIPS Password Management Policy
Appendix H	SBN Products for WAN Transmission During an SBN Failure
Appendix I	Administrative Tips for Monitoring System Performance
Appendix J	WarnGen Templates
Appendix K	Reporting Problems to the NCF: Tips on Completing Trouble Ticket Worksheets and Describing Slow Workstation Performance and Completing the Trouble Ticket Express form
Appendix L	LDAD Configuration Samples and Firewall Architecture
Appendix M	Acceptable Formats for Importing Climate Data
Appendix N	AWIPS National Datasets
Appendix O	NWRWAVES User's Manual & Documentation
Appendix P	Diagnosing System Health
Appendix Q	AWIPS Applications and Version Numbers
Appendix R	System Architecture Diagrams
Appendix S	CAVE Localization Perspective
Appendix T	Service Backup
Appendix U	AWIPS II Component Categorization
Appendix V	Adding D2D Model Data into GFE
Appendix W	WarnGen Urban Boundaries
Appendix X	Metar2shef Data Conversion Process Elements, Tokens and Files

Appendix Y	Configuring the NetCDF Grid Decoder
Appendix Z	What's New in SMM OB 16.2.2
Appendix AA	Instructions to Ingest ARI for your Site
Appendix BB	National Centers for Environmental Prediction (NCEP) AWIPS/NAWIPS Migration Documentation

## **Chapter 2**

# **AWIPS System Architecture**

## Chapter 2. AWIPS System Architecture

### Table of Contents

		<i>Page</i>
2.1	AWIPS Communications Network.....	1
2.1.1	AWIPS Satellite Broadcast Network.....	3
2.1.2	AWIPS WAN.....	4
2.1.2.1	Mobile Very Small Aperture Terminal (VSAT) WAN Backup.....	7
2.1.3	LAN.....	7
2.1.4	Routers.....	7
2.1.5	Circuits.....	13
2.1.6	NESDIS Interface Router.....	13
2.2	Site Hardware Architecture.....	13
2.2.1	Rack Components.....	14
2.2.1.1	Satellite Broadcast Network (SBN).....	20
2.2.1.2	Synchronous Communications.....	22
2.2.1.3	Application Server.....	23
2.2.1.4	Data Servers 23	
2.2.1.4.1	Data Server File Systems and Raw Partitions.....	25
2.2.1.4.1.1	File Systems on the Linux Data Server (DX).....	26
2.2.1.4.1.2	Raw Partitions for PostgreSQL on the Linux Data Server.....	30
2.2.1.4.2	AX File Systems.....	30
2.2.1.5	LDAD Hardware.....	33
2.2.1.5.1	LDAD Server File Systems.....	35
2.2.1.6	Workstations 37	
2.2.1.6.1	Reserved.....	38
2.2.1.6.2	Linux Workstation File Systems.....	38
2.2.1.7	Linux Preprocessor.....	40
2.2.1.7.1	Preprocessor Server File Systems.....	43
2.2.1.7.2	Preprocessor Server File Systems.....	44
2.3	NCF Time Source.....	46
2.4	Printers.....	46
2.5	AWIPS Software.....	46
2.5.1	AWIPS Contractor-Developed Software.....	46
2.5.2	Government-Developed Software.....	47
2.5.3	Commercial Off-the-Shelf (COTS) Software and Freeware.....	47
2.5.3.1	AWIPS II: COTS Software and Freeware.....	47



2.5.3.2	Mobile Code Technologies.....	51
2.6	AWIPS I and AWIPS II .....	52
2.6.1	What’s Changed in AWIPS.....	52
2.6.2	What’s Not Changed in AWIPS.....	54
2.7	Basic AWIPS II Software Deployment.....	54
2.8	AWIPS II Server Clustering.....	59
2.9	Basic AWIPS II Communication Architecture .....	60
2.10	Basic AWIPS II Logging Architecture.....	61
2.11	Basic AWIPS II Data Storage Architecture .....	62
2.12	Basic AWIPS II Visualization Architecture.....	63
2.13	Basic AWIPS II Data Processing Architecture .....	64
2.13.1	Basic AWIPS II Data Receipt Architecture.....	64
2.13.2	Basic AWIPS II Data Decoding Architecture .....	65
2.13.3	Basic AWIPS II Data Storage Architecture.....	66
2.13.3.1	AWIPS II Raw Data Storage .....	66
2.13.3.2	AWIPS II Processed Data Storage .....	69
2.13.3.3	PyPIES (Python Process Isolated Exchange Storage) .....	72
2.13.4	Basic AWIPS II Data Retrieval Architecture .....	73
2.15	Basic AWIPS II Data Purge Architecture .....	74
2.15.1	AWIPS II Processed Data Storage Purge Architecture .....	75
2.15.2	AWIPS II Raw Data Storage Purge Architecture.....	75
2.16	AWIPS II Localization Store .....	76
2.17	EDEX Distribution Files.....	77
2.17.1	Editing an EDEX Distribution File .....	77

### **List of Exhibits**

Exhibit 2-1.	AWIPS System Boundaries and Subsystems.....	2
Exhibit 2.1.1-1.	AWIPS Communications Network.....	3
Exhibit 2.1.2-1.	AWIPS sites interconnected via OPSnet MPLS.....	6
Exhibit 2.1.2.1-1.	Block Diagram of VSAT System Setup at a WFO.....	8
Exhibit 2.1.4-1.	Interconnection of Wide Area Network Devices .....	9
Exhibit 2.1.4-2.	WFO Router Connection Diagram .....	10
Exhibit 2.1.4-3.	IP Router Connection Diagram for NC .....	11
Exhibit 2.1.4-4.	RFC Router Connection Diagram.....	12
Exhibit 2.2-1.	Stand-Alone WFO Site Hardware Architecture .....	15
Exhibit 2.2-2.	RFC Site Hardware Architecture.....	16
Exhibit 2.2-3.	LDAD Hardware Architecture.....	17

Exhibit 2.2-4. AWIPS WFO Network Diagram .....	18
Exhibit 2.2.1-1. Standard Stand-Alone WFO/RFC Rack Configuration.....	19
Exhibit 2.2.1.6-1. AWIPS Workstation .....	37
Exhibit 2.2.1.7-1. Linux Preprocessors (PX) Architecture .....	41
Exhibit 2.2.1.7-2. Linux Preprocessor (PX) Hardware .....	42
Exhibit 2.2.1.7-3. Linux Preprocessor (FX) Interfaces .....	43
Exhibit 2.7-1. Overall AWIPS II Data Flow .....	56
Exhibit 2.7-2. Overall AWIPS II Servers Processes .....	57
Exhibit 2.7-3. AWIPS II Servers Overview .....	58
Exhibit 2.9-1. AWIPS II Inter-Process Communication.....	61
Exhibit 2.12-1. AWIPS II Visualization .....	63
Exhibit 2.13.1-1. AWIPS II Data Receipt.....	64
Exhibit 2.13.2-1. AWIPS II Data Decoding .....	65
Exhibit 2.13.3.1-1. AWIPS II Raw Data Storage .....	67
Exhibit 2.13.3.2-1 AWIPS II Processed Data Storage.....	70
Exhibit 2.13.3.2-2. CAVE/Processed Data Storage Interaction.....	71
Exhibit 2.13.4-1. AWIPS II Data Retrieval .....	73
Exhibit 2.14-1. AWIPS II Message Retransmission.....	74
Exhibit 2.15.1-1. AWIPS II Processed Data Storage Purge.....	75
Exhibit 2.16-1. CAVE/Localization Store Interaction.....	76

### **List of Tables**

Table 2.2.1.4-1. Data Server Configurations at AWIPS Sites .....	24
Table 2.2.1.4-2. WFO Archive Server Configuration at AWIPS Sites.....	25
Table 2.2.1.4-3. RFC Archive Server Configuration at AWIPS Sites.....	25
Table 2.2.1.6-1. Workstation Processor Configurations at AWIPS Sites.....	38
Table 2.2.1.7-1. Linux Preprocessor Configurations at AWIPS Sites .....	42
Table 2.5.3.1-1. COTS Software and Freeware Used in AWIPS II.....	47
Table 2.7-1. AWIPS II Software.....	58
Table 2.8-1. AWIPS II Server Failover Strategies.....	59
Table 2.8-2. AWIPS II Server Aliases .....	60
Table 2.10-1. Log Locations for AWIPS II Components .....	62
Table 2.11-1. AWIPS II Data Storage.....	62
Table 2.13.1-1. AWIPS II Interfaces to Data Sources .....	65

The design of the AWIPS system architecture is driven by the requirements for expandability, flexibility, availability, and portability. This system has been designed for easy expandability to allow for the introduction of new functionality and the augmentation of network and processing capacities. AWIPS can accommodate the evolving state of operational forecasting to enable the NWS to meet the objectives of the modernization effort. AWIPS is designed so that software and data can be migrated to new platforms as technology evolves.

The AWIPS system architecture illustrated in Exhibit 2-1 gives a macro-level view of the AWIPS system with the various types of AWIPS sites and the interfaces to external entities, including the following:

- Network Control Facility (NCF)
- Satellite Broadcast Network (SBN)
- Wide Area Network (WAN)
- Weather Forecast Office (WFO)
- River Forecast Center (RFC)
- National Center (NC)
- NOAAPORT Receive System (NRS)

Information flows into the AWIPS NCF (ANCF) in Silver Spring, Maryland, or the Backup NCF (BNCF) in Fairmont, West Virginia, from the National Weather Service Telecommunications Gateway (NWSTG) and the National Environmental Satellite, Data, and Information Service (NESDIS). These data are sent to all AWIPS and NRS sites via the SBN.

The WAN provides additional communications infrastructure utilizing TCP/IP point-to-multipoint (PTM) communications, which allows AWIPS sites to communicate with each other. In addition to the data received from the NCF, AWIPS sites have access to data from local sources, such as the Automated Surface Observing System (ASOS), the Weather Surveillance Radar-1988 Doppler (WSR-88D) radar, and Terminal Doppler Weather Radars. [**Note:** All channels except GOES support automatic retransmission. GOES does not because the NCF software does not support it.]

## **2.1 AWIPS Communications Network**

The AWIPS Communications Network (ACN) is a nationwide communications system consisting of an SBN and a WAN.

The SBN provides PTM communications between the NCF and all sites. It is used to distribute satellite, radar, grid, text, graphic, synoptic, BUFR (Binary Universal Form for data Representation), and point data to the sites from the National Centers for Environmental Prediction (NCEP), NESDIS, the NWSTG, AWIPS sites, and other data sources.

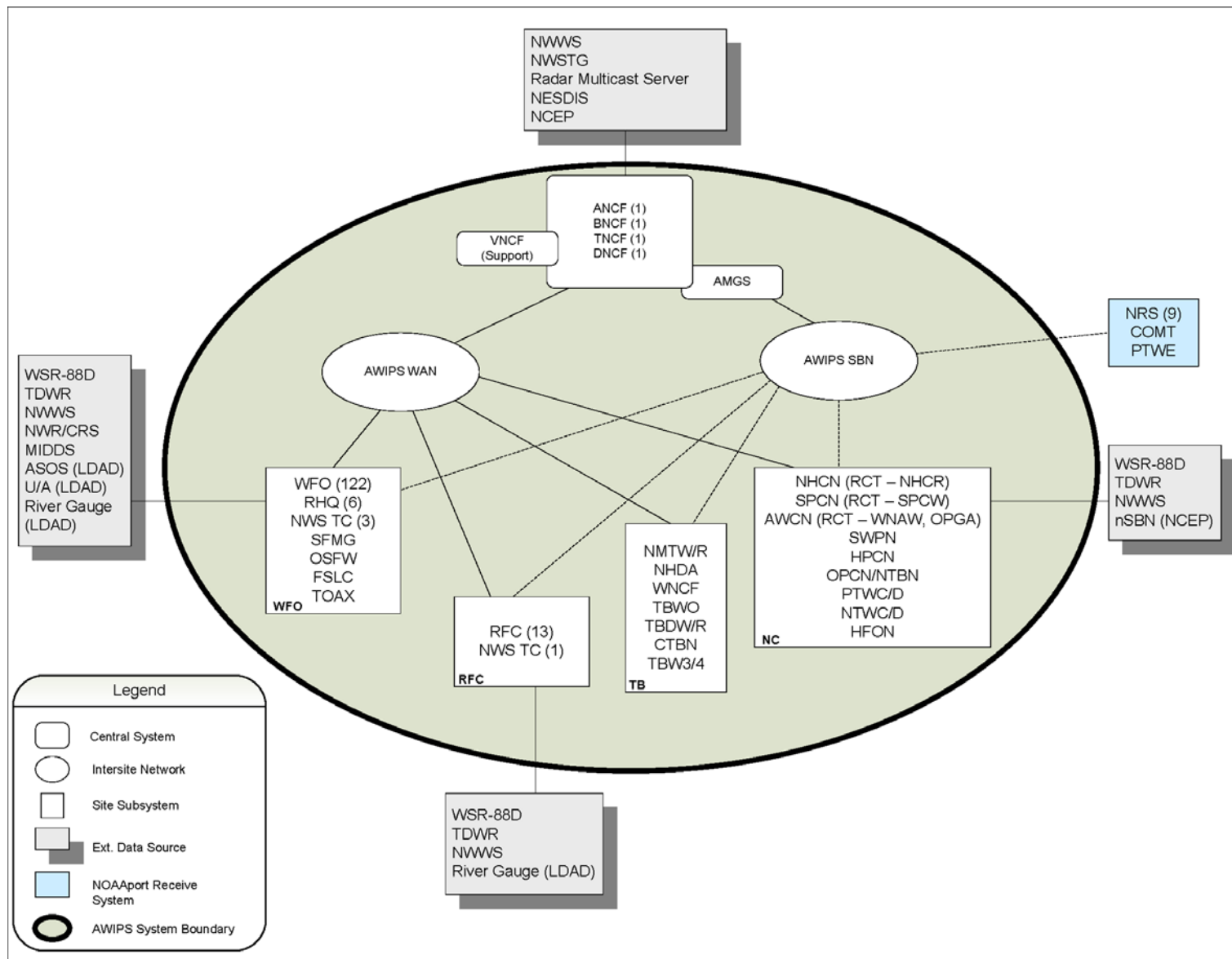
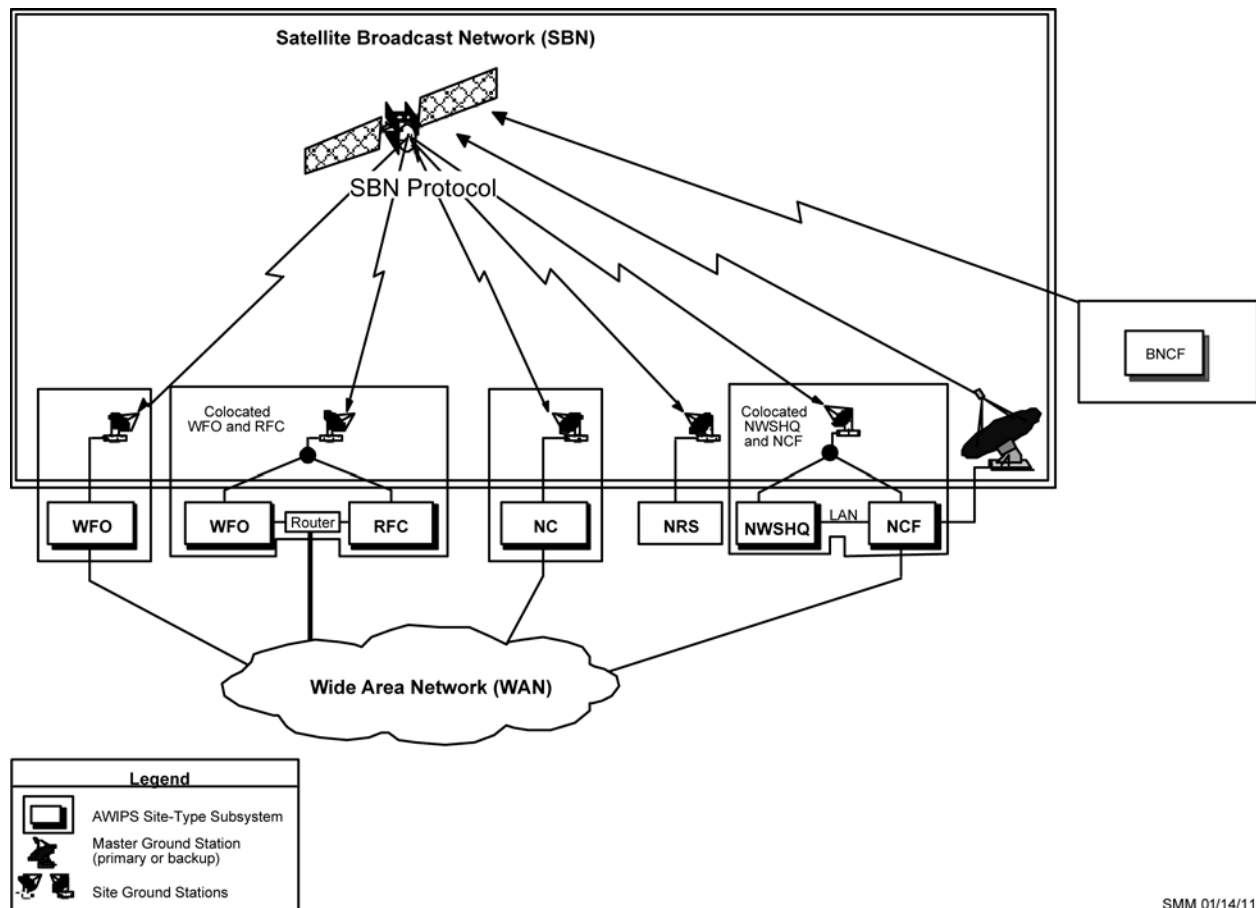

Exhibit 2-1. AWIPS System Boundaries and Subsystems

The WAN provides TCP/IP (PTM) communications between all AWIPS sites. It is used to send data from one site to any other site. There is also a backup system that consists of a dial-up modem that the NCF can use to dial into a site.

**2.1.1 AWIPS Satellite Broadcast Network**

The SBN is a PTM network that distributes weather data from the NCF or the BNCF to receiving sites throughout the United States (see Exhibit 2.1.1-1). The network consists of the Satellite Broadcast Processor (SBP); the uplink Master Ground Station (MGS) antenna in Hauppauge, New York, and the backup MGS (BMGS) antenna at the NASA Independent Verification and Validation (IV&V) Facility in Fairmont, West Virginia; the SES-1 satellite; the downlink antenna at the locations receiving data; and the satellite Digital Video Broadcast (DVB) receivers at the sites. Primary data transmitted are Geostationary Operational Environmental Satellite (GOES)-EAST and GOES-WEST satellite imagery, model data, observational data, and text products. [Note: All channels except GOES support automatic retransmission. GOES does not because the NCF software does not support it.]



SMM 01/14/11

**Exhibit 2.1.1-1. AWIPS Communications Network**

The NCF and the BNCF receive the satellite and model data from NESDIS and the NCEP, respectively. The data is processed at the NCF or the BNCF, stored on disk, and sent to the MGS in Hauppauge or the BMGS in Fairmont. The primary MGS is a commercial satellite communications facility owned by Globecom Systems, Inc. (Globecom or GSI); the BMGS is a Government-owned facility. Both the primary and the backup MGS transmit the data to a commercial communications satellite (SES-1) that transmits the data to the sites.

The MGS uses the frequency division multiple access (FDMA) transmission technique. Four different substreams are required to transmit SBN data. Each site receiving data can be customized to receive only those streams that are appropriate for its mission. Ninety percent of the sites need only two of the four data streams. A channel failure does not result in total loss of all data streams, only the affected channel.

### 2.1.2 AWIPS WAN

The AWIPS WAN is a terrestrial network designed to support distribution of PTM data among all AWIPS sites. The WAN gives field sites, NCs, and headquarters sites the ability to communicate with each other and send data to the central facility for rebroadcast. The data includes products and messages generated by the local AWIPS office and observation data generated or received by the local AWIPS office from systems external to AWIPS. Messages or information intended for transmission from one AWIPS site to another or directly to the NCF (PTM) will be sent via the WAN. AWIPS also supports other types of traffic at sites as follows:

- Interactive capabilities
- Request/reply data
- Retransmission requests for lost products
- Error and fault notification from sites to the NCF
- Remote log-in from site to site
- Distribution of software releases from the NCF
- Remote diagnostic action by the NCF
- Network management.

The WAN provides an infrastructure for field sites to provide backup support for other sites if an operations failure occurs.

The WAN is also used to synchronize all AWIPS system clocks using the Network Time Protocol (NTP). The AWIPS time source is located at the NCF/BNCF; it receives and decodes time from the National Institute of Standards and Technology (NIST) time-signal broadcast call letters (WWV) external time source and provides that information to AWIPS. After the NCF/BNCF communication server is synchronized with the NIST WWV, it synchronizes all other local area network (LAN) clocks at the site. The NCF/BNCF broadcasts the time to all the other AWIPS sites over the WAN. All AWIPS system clocks are synchronized to within 1 second of the NIST WWV time.

The circuits provide site interconnection at up to 1.5 Mbps. The WAN's high availability is achieved by incorporating real-time network management, supplying capacious circuits, providing multiple paths between nodes, and implementing backup circuits for dedicated links.

The types of circuits used in the WAN are as follows:

- GRE tunnels are provided for CONUS AWIPS sites. The terrestrial network uses OPSnet's Virtual Private Network. It is based on fast packet technology and aimed at high-speed, bursty data applications such as LAN connections. OPSnet utilizes Multi-Protocol Label Switching (MPLS) for the WAN backbone. Each site has access to the highly scalable meshed cloud using a VRF (Virtual Routing and Forwarding) connection between the site's CE router to the provider edge (PE) router. See Section 2.1.4, Routers, which illustrated the any-to-any network; from the WFO to the RFC and from the RFC to the NCF.
- OPSnet High Availability (HA) VSAT (Very Small Aperture Terminal) backup services for 63 AWIPS sites. VSAT technology utilizes two-way satellite communications in the event the HA site loses its terrestrial path to the AWIPS WAN.
- Switched Data Service (SDS) circuits provide backup for AWIPS sites. Dial backup circuits are provided at all locations without VSAT backup services. Each non development site has an FTS2001 SDS circuit connected to a router port for use as a dial-up backup to the dedicated link. Colocated WFO/RFC sites have four SDS circuits.
- Monitor and control functions use Switched Voice Service (SVS) circuits for out-of-band access to the AWIPS terminal server.
- Integrated Services Digital Network (ISDN) circuits provide backup for AWIPS sites along with the SDS circuit.

Exhibit 2.1.2-1, shows all of the AWIPS sites interconnected via OPSnet MPLS. The AWIPS WAN topology is an 'Any-to-Any' network architecture that replaced the 'Hub-and-Spoke' design.

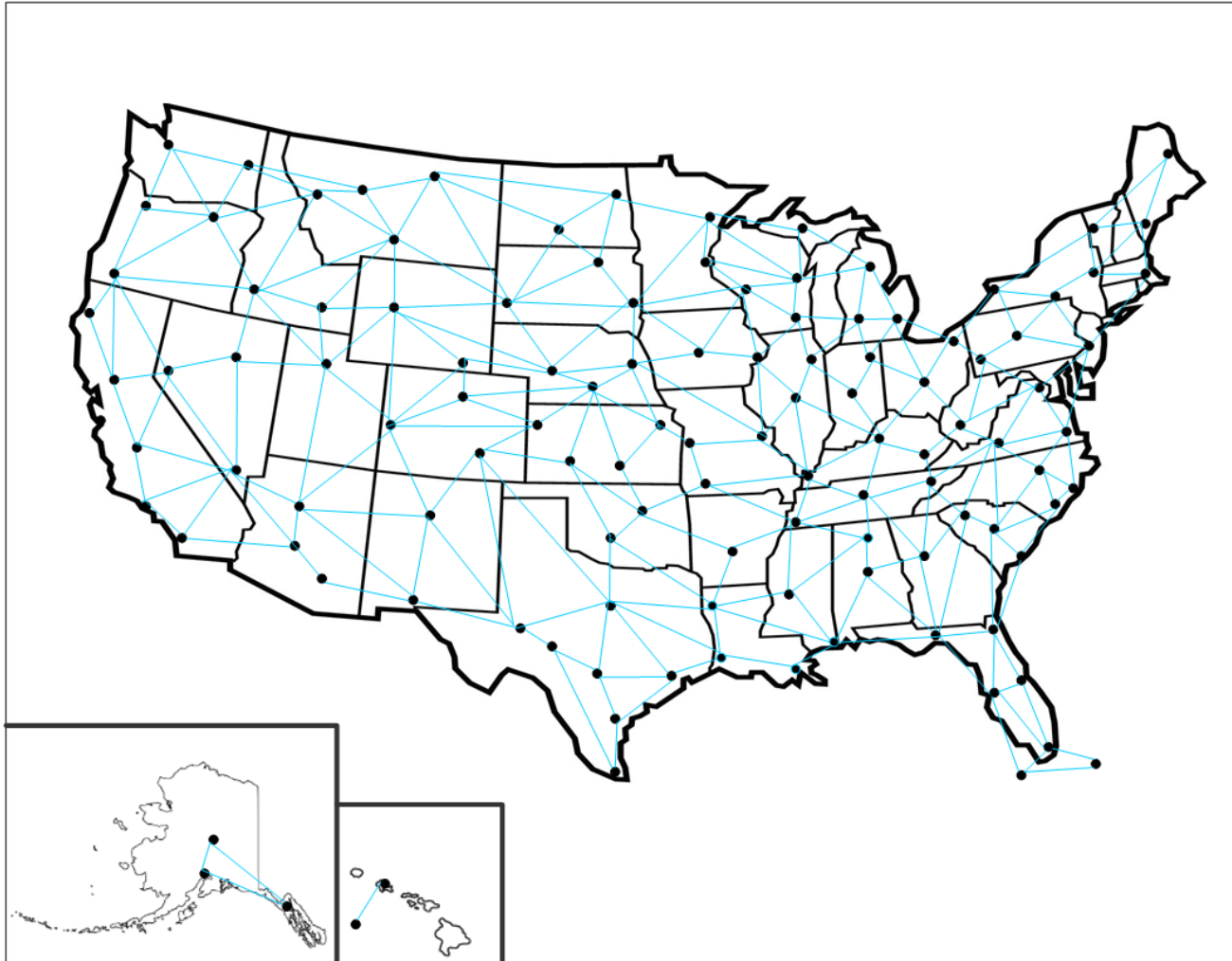

**Exhibit 2.1.2-1. AWIPS sites interconnected via OPSnet MPLS**



### 2.1.2.1 *Mobile Very Small Aperture Terminal (VSAT) WAN Backup*

When a site loses its AWIPS WAN connection for what is expected to be an extended period of time due to some kind of disaster, or when a test of the system is desired, the NWS will notify Raytheon that the backup system (one or more of the VSAT systems) is required. At the same time, the NWS will work with the affected region and site to ensure access to the affected site for the equipment and a Field Site Representative (FSR). The Raytheon AWIPS Team will immediately deploy a Flyaway Satellite Terminal and an FSR to the affected site(s). The FSR will set up the terminal and, working with the local Electronic Systems Analyst (ESA), connect the satellite terminal to the site LAN in place of the non-functional WAN. Once the terminal becomes operational, the deployed technician will return home. The AWIPS NCF will monitor the communications link via existing T1 lines to the Network Operations Center (NOC) of the Long Island International Teleport (LIIT) at Hauppauge, NY, as it does for the AWIPS WAN. LIIT is operated by Raytheon AWIPS teammate Globecom.

The NWS Radar Operations Center (ROC) will be kept in the loop on all VSAT deployment activities in order to be available for possible backup support.

When the AWIPS WAN has been returned to operational status, the Raytheon AWIPS Team FSR will return to the site to disconnect and take down the satellite terminal and return it to its storage location.

Detailed deployment procedures are outlined in AWP.PLN.AWB-01.02, *AWIPS VSAT WAN Backup: Deployment Plan and Concept of Operations*, dated May 5, 2011. A block diagram of the VSAT system setup at a WFO is provided in Exhibit 2.1.2.1-1.

### 2.1.3 *LAN*

The AWIPS site LAN comprises industry-standard 100/1000Base-T Ethernet network technologies to support the distribution of data throughout the AWIPS sites. The LAN provides concurrent transmission of data at speeds of 1000 Mbps, and a 1 Gbps wire speed is provided to each Ethernet interface. The LAN is implemented via Cisco 2960 switches for all AWIPS sites.

### 2.1.4 *Routers*

Cisco routers are used to pass data from the site LAN to the WAN and to the site LAN from the WAN. WFO routers are sized to connect to one LAN and employ two Ethernet connections to the Site CE Router. RFC and NC routers are sized to connect to two LANS and employ between two Ethernet connections to the Site CE Router. Exhibits 2.1.4-1 through 2.1.4-4 show how the routers interface with the LAN and the WAN.

**NOTE:** At a colocated site, the RFC provides the routers for both the RFC and the WFO.

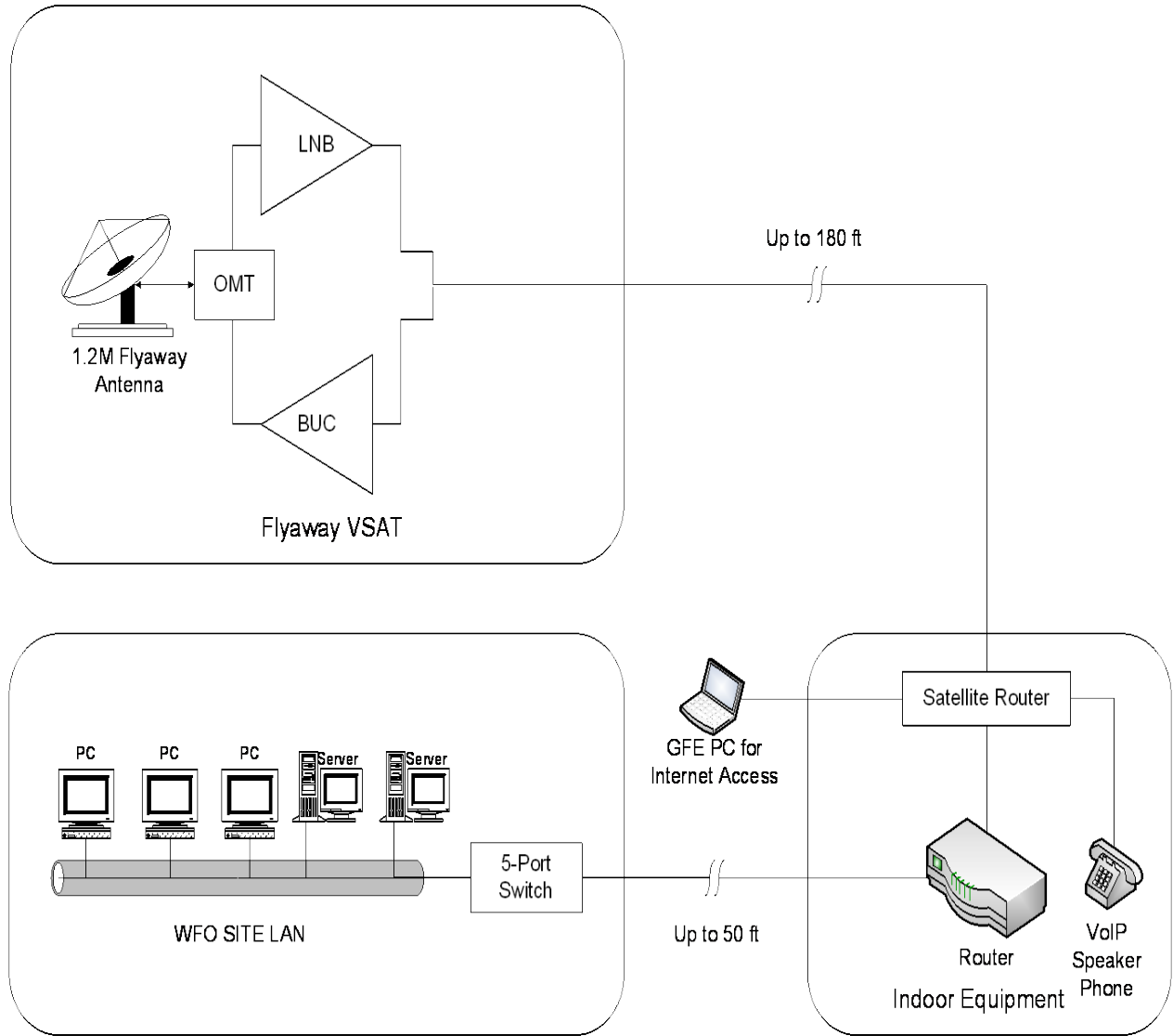

**Exhibit 2.1.2.1-1. Block Diagram of VSAT System Setup at a WFO**

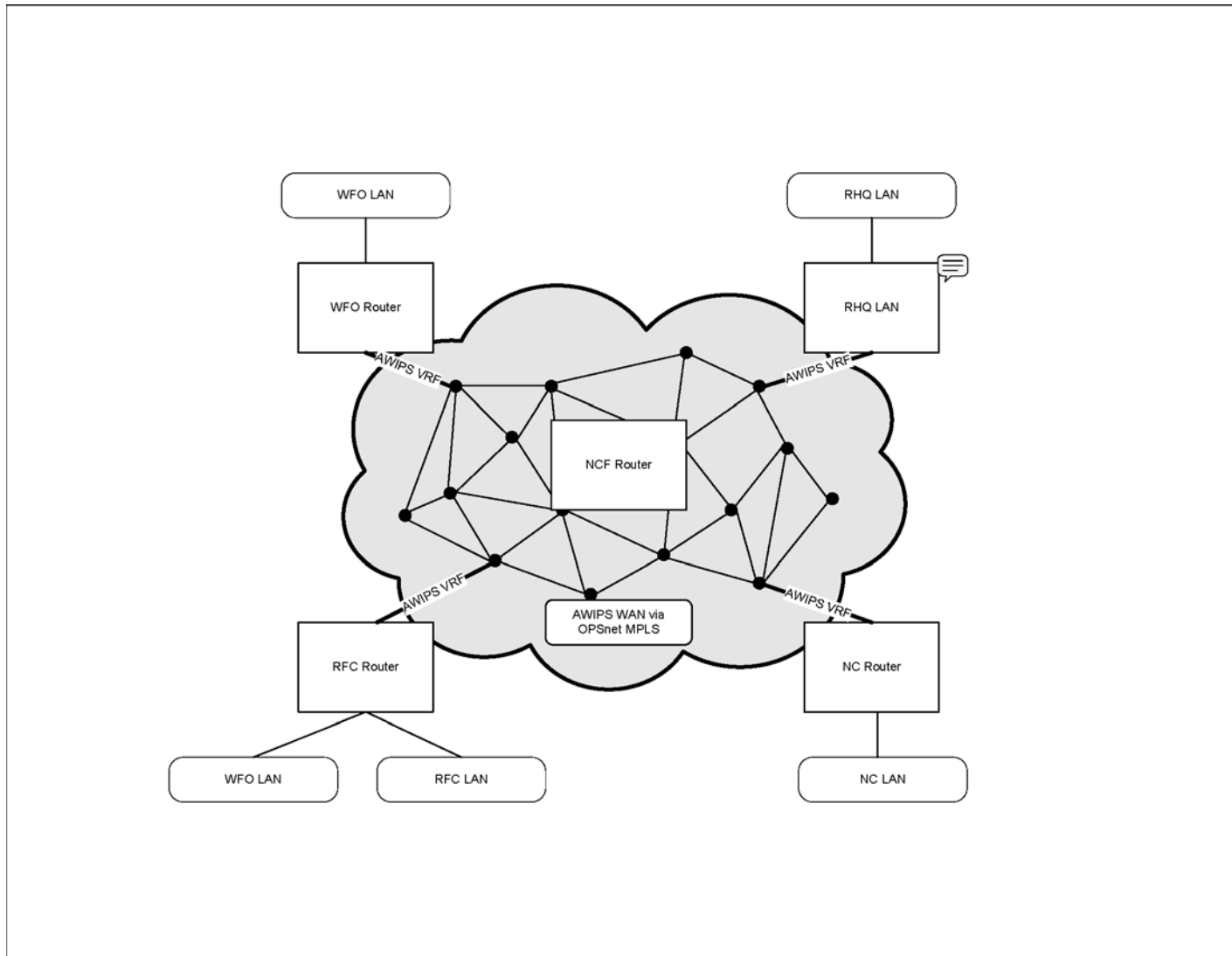

**Exhibit 2.1.4-1. Interconnection of Wide Area Network Devices**

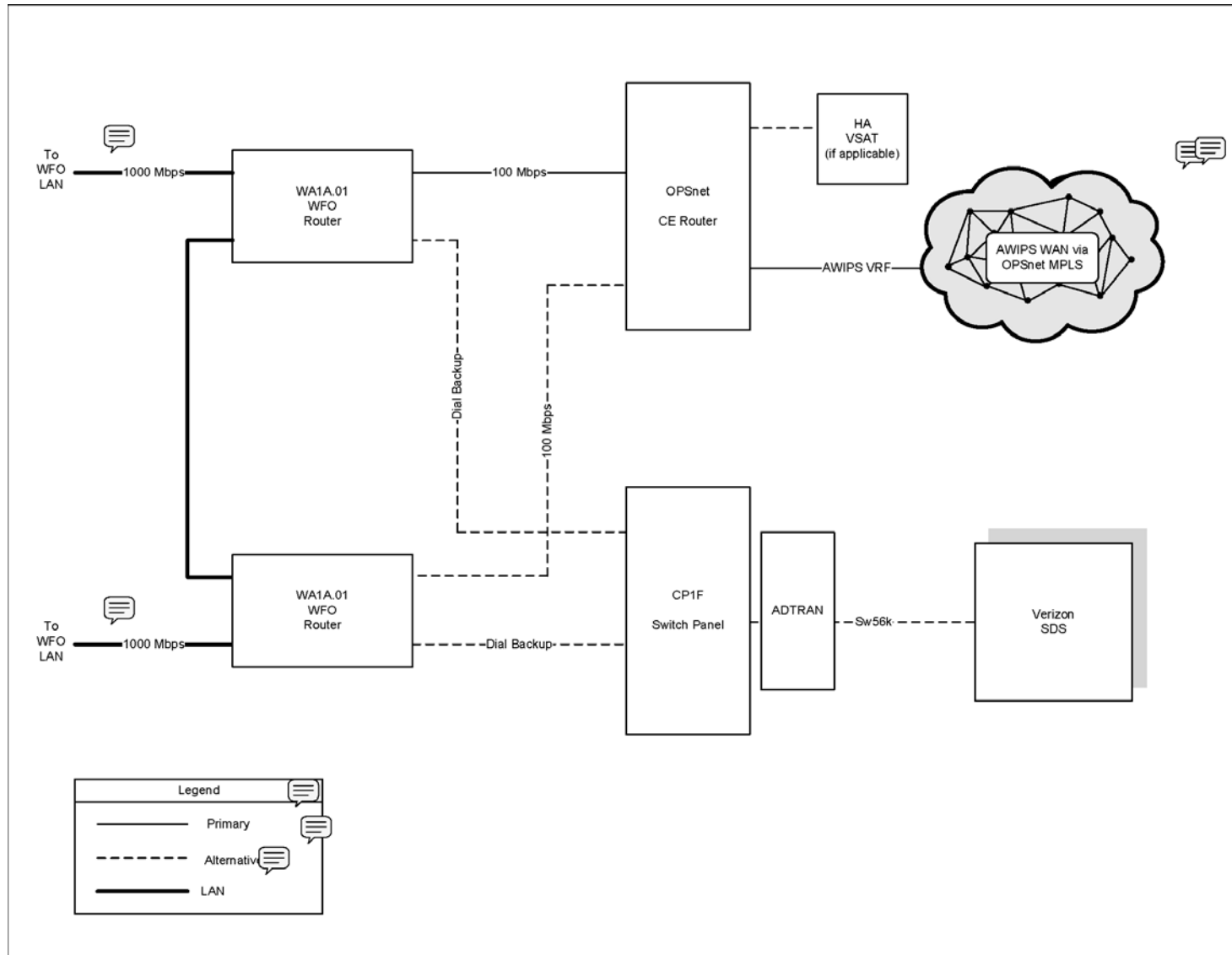

Exhibit 2.1.4-2. WFO Router Connection Diagram

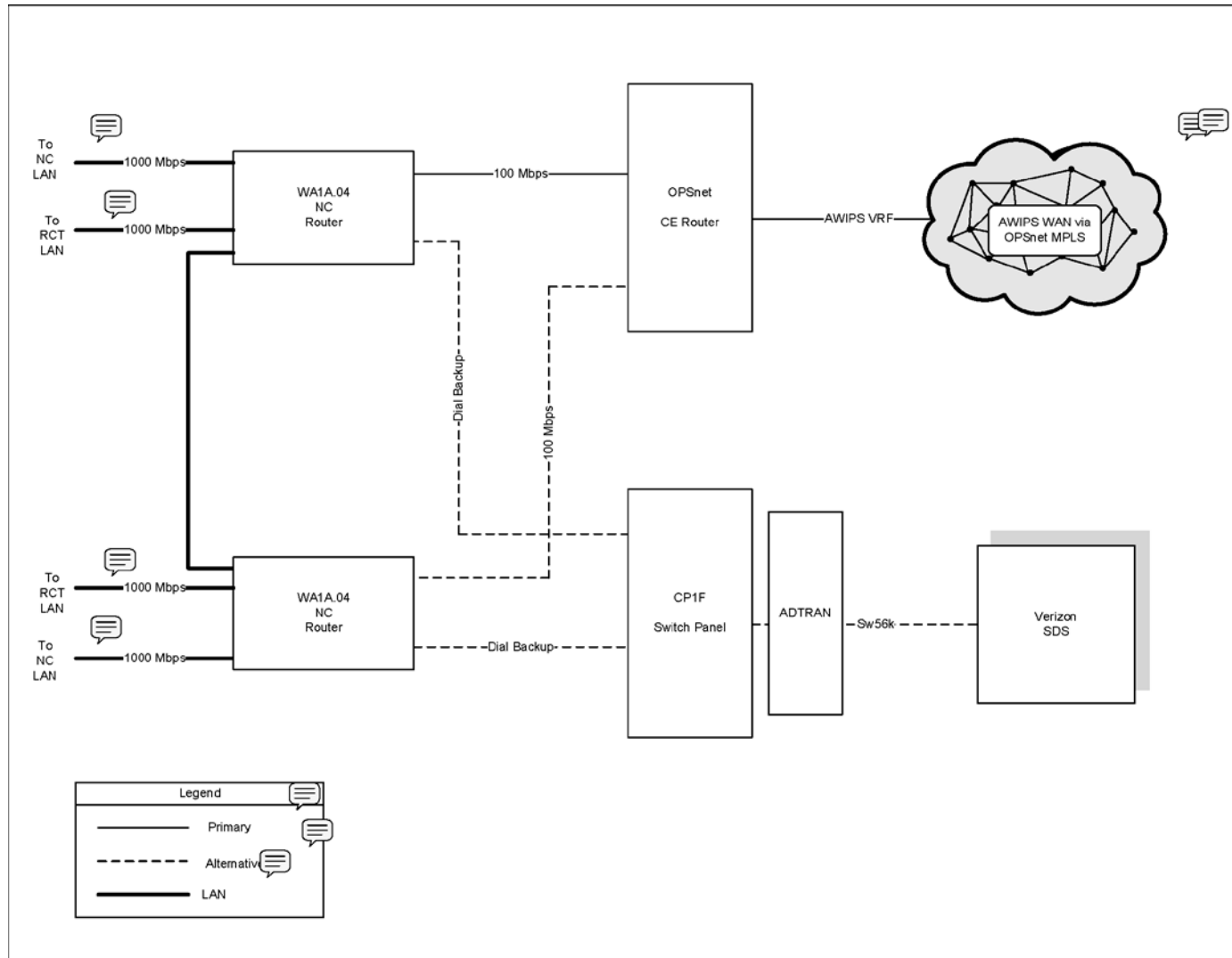

Exhibit 2.1.4-3. IP Router Connection Diagram for NC

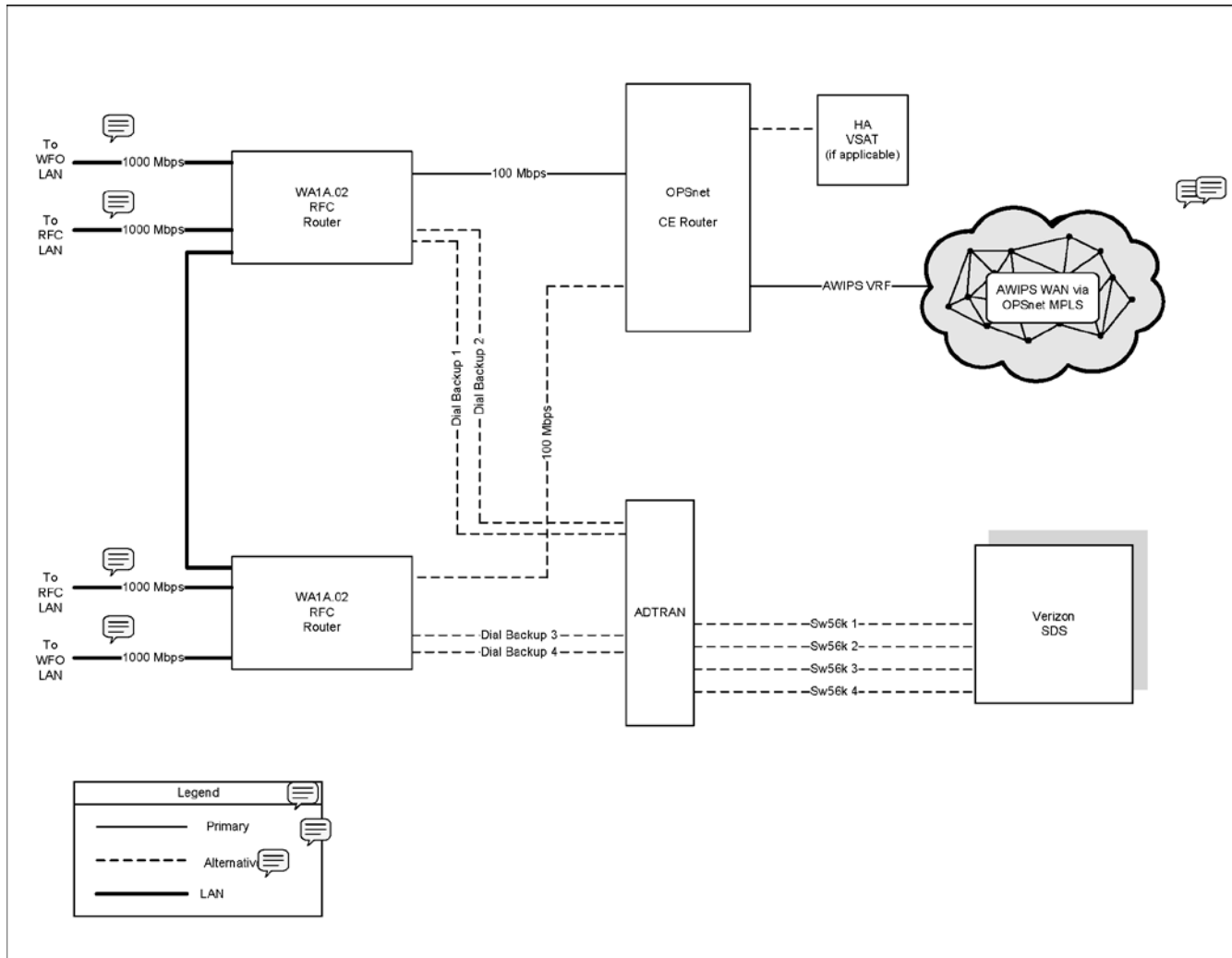

Exhibit 2.1.4-4. RFC Router Connection Diagram

### 2.1.5 *Circuits*

The communications processor (CP) circuits provide connectivity between AWIPS and external systems. Four point-to-point terrestrial NESDIS circuits provide connectivity between the ESPC and the NCF, and two terrestrial point-to-point circuits provide connectivity between ESPC and the BNCF. These circuits are external to AWIPS and outside the ACN.

### 2.1.6 *NESDIS Interface Router*

Ten routers provide the AWIPS-NESDIS routing function. Five of these routers are located at ESPC (Suitland, MD), two at the ANCF, two at the BNCF and one at TNCF.

## 2.2 *Site Hardware Architecture*

The AWIPS site hardware architecture has been standardized across all AWIPS site types (WFOs, RFCs, RHQs and NCs) so that the only differences are in quantity (i.e., number of workstations and amount of disk space) and, at the NCs, some additional peripheral items.

Each AWIPS site functions independently with its own hardware. Because the RFC sites and the colocated WFO system share the WAN routers, the colocated WFO systems do not have WAN routers.

Each site has a site ground station (SGS) that receives the SBN signal. The SGS is provided and supported by Globecom, under subcontract to Raytheon. The Pacific Tsunami Warning Center (PTWC) has the antenna that serves the WFO in Guam and Honolulu WFO.

The SGS consists of the following:

- A receive-only antenna that provides the physical interface to the SBN.
- A low-noise-block (LNB) down-converter that converts the C-band satellite signal to lower L-band frequencies.
- The interfacility link (IFL), which is the cable from the antenna to the DVB Receivers.
- Redundant DC power supplies that provide power to the LNB.
- DVB receivers that receive the digital data stream from the SBN and transmit it to the CPs.

Colocated AWIPS sites take advantage of an IFL splitter to share the SGS antenna feed. Locations with more than two AWIPS installations also use an IFL splitter with multiple output ports (up to 8 per splitter).

All AWIPS sites use client/server technology to achieve function reuse, failure recovery, and functional partitioning. The servers are as follows:

- **WFO Archive Server (WAX).** WAX, a Linux-based device is currently only used for tape backup. It runs the weekly nas backup script because the tape device is connected to it.
- **RFC Archive Server (RAX).** RAX, a Linux-based device, provides additional disk storage capacity for hydrologic data via Postgres database and provides the processing power and associated software to process this hydrologic data at RFCs.
- **Linux Data Servers (DX).** The DXs provides site-level decoding, message handling and data acquisition processing and hosts the DNS, NTP, SNMP, and LDAD TerminalServer. It also provides site-level data repository and database resources.
- **Workstations.** The AWIPS workstations are used to access all site-level system functions; they are also used to process and display textual, graphical, and image data.
- **Communications Processors.** The CPs provide site-level interface and processing to external communications.
- **Local Data Acquisition and Dissemination (LDAD) server.** The LDAD server provides local data acquisition, data quality control, and dissemination interfaces for local NWS offices.
- **Linux Preprocessors (PX).** The PXs provide additional data processing and storage ability for hydrometeorological applications.

The following exhibits illustrate the site hardware architecture:

- WFO (Exhibit 2.2-1)
- RFC (Exhibit 2.2-2)
- LDAD (Exhibit 2.2-3).

The WFO network diagram (Exhibit 2.2-4) represents the interface between the AWIPS LAN and the NOAAnet. The diagram illustrates the physical connections between the AWIPS routers and the NOAAnet routers.

### 2.2.1 Rack Components

Hardware is usually installed at each site in standard WFO and RFC rack configurations, as shown in Exhibit 2.2.1-1. There are stand-alone WFO rack configurations and collocated WFO rack configurations. Collocated WFO racks include all stand-alone equipment except for routers, which are provided by the collocated RFC.



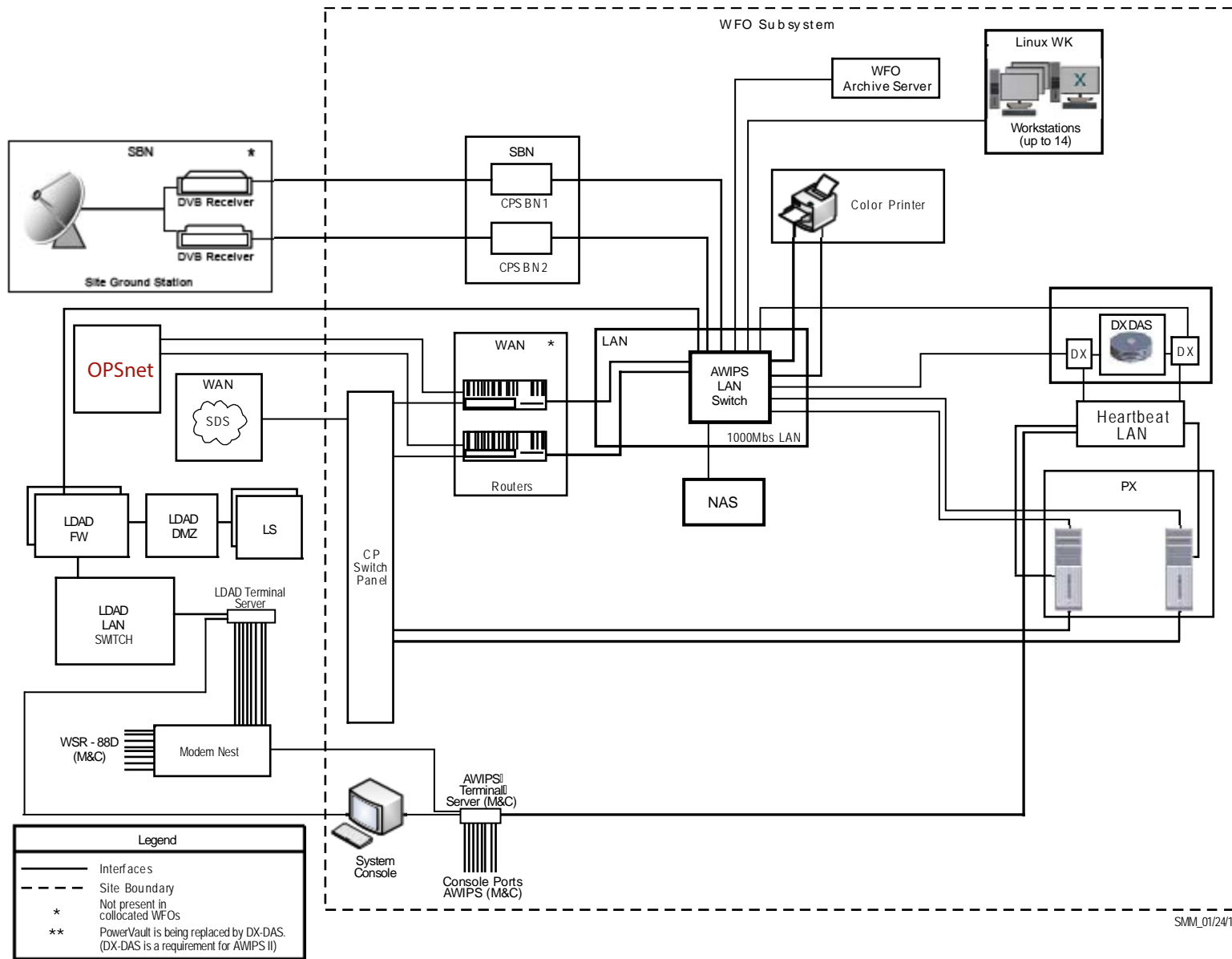

Exhibit 2.2-1. Stand-Alone WFO Site Hardware Architecture

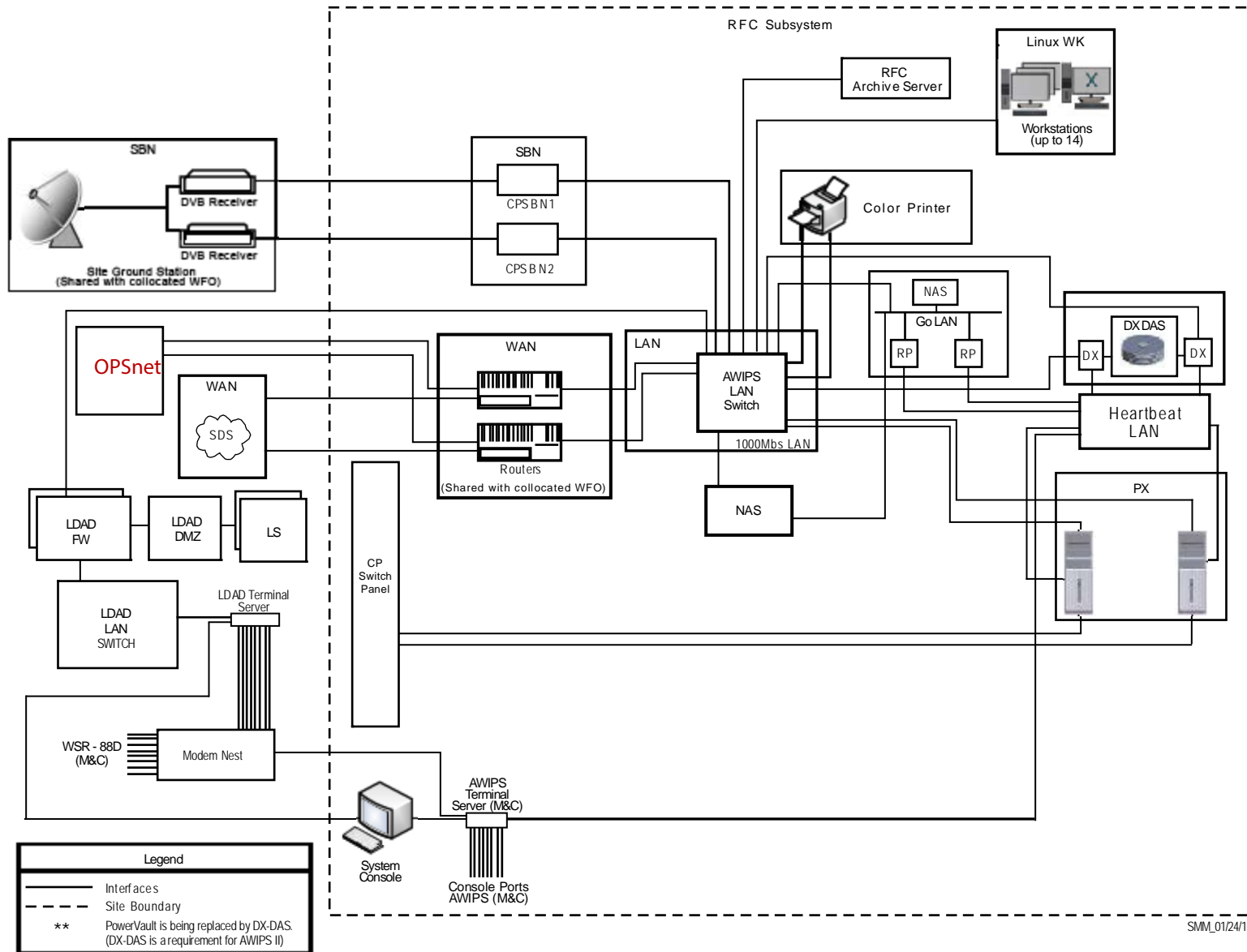
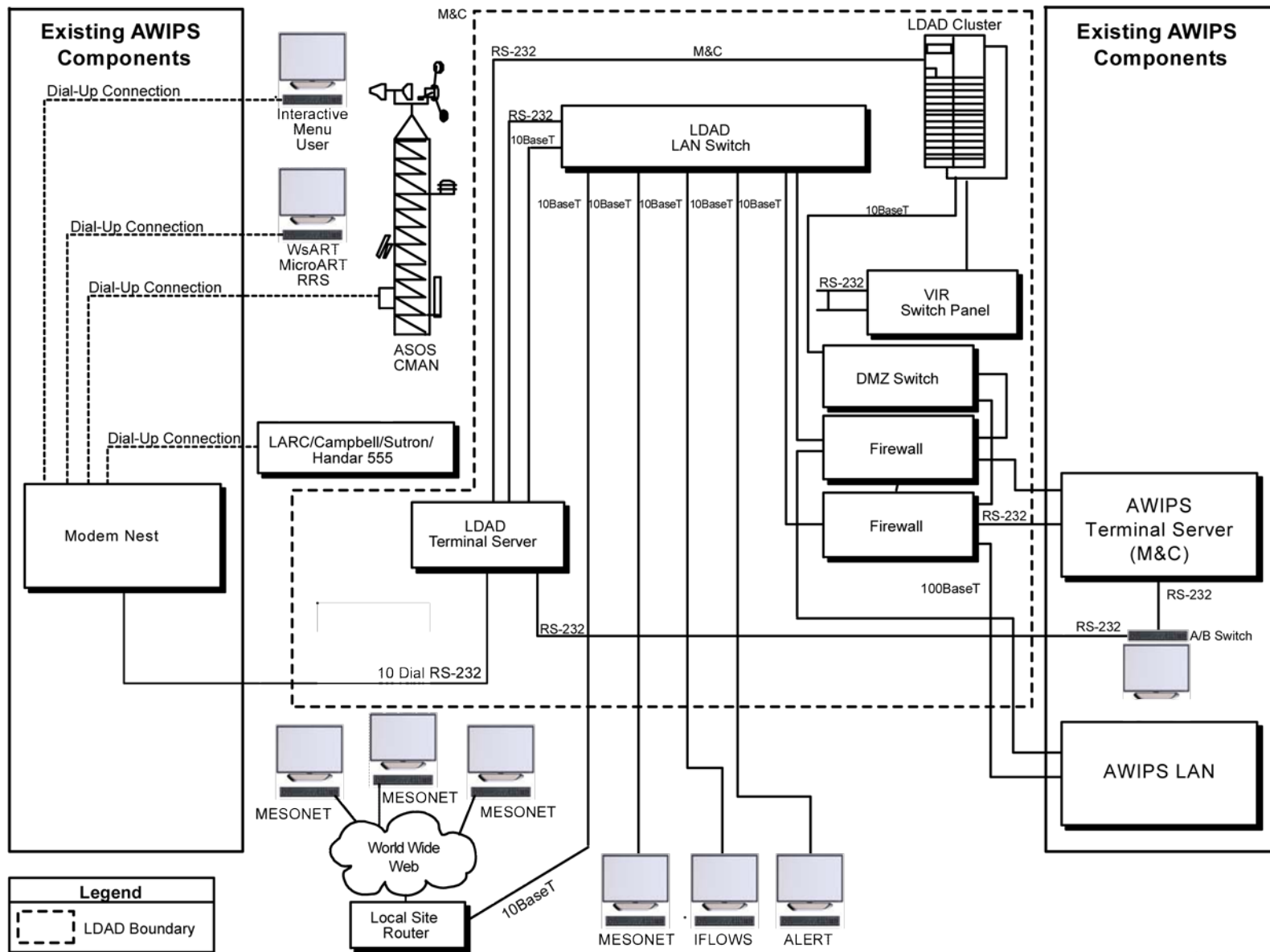

Exhibit 2.2-2. RFC Site Hardware Architecture



SMM 09/17/14

Exhibit 2.2-3. LDAD Hardware Architecture

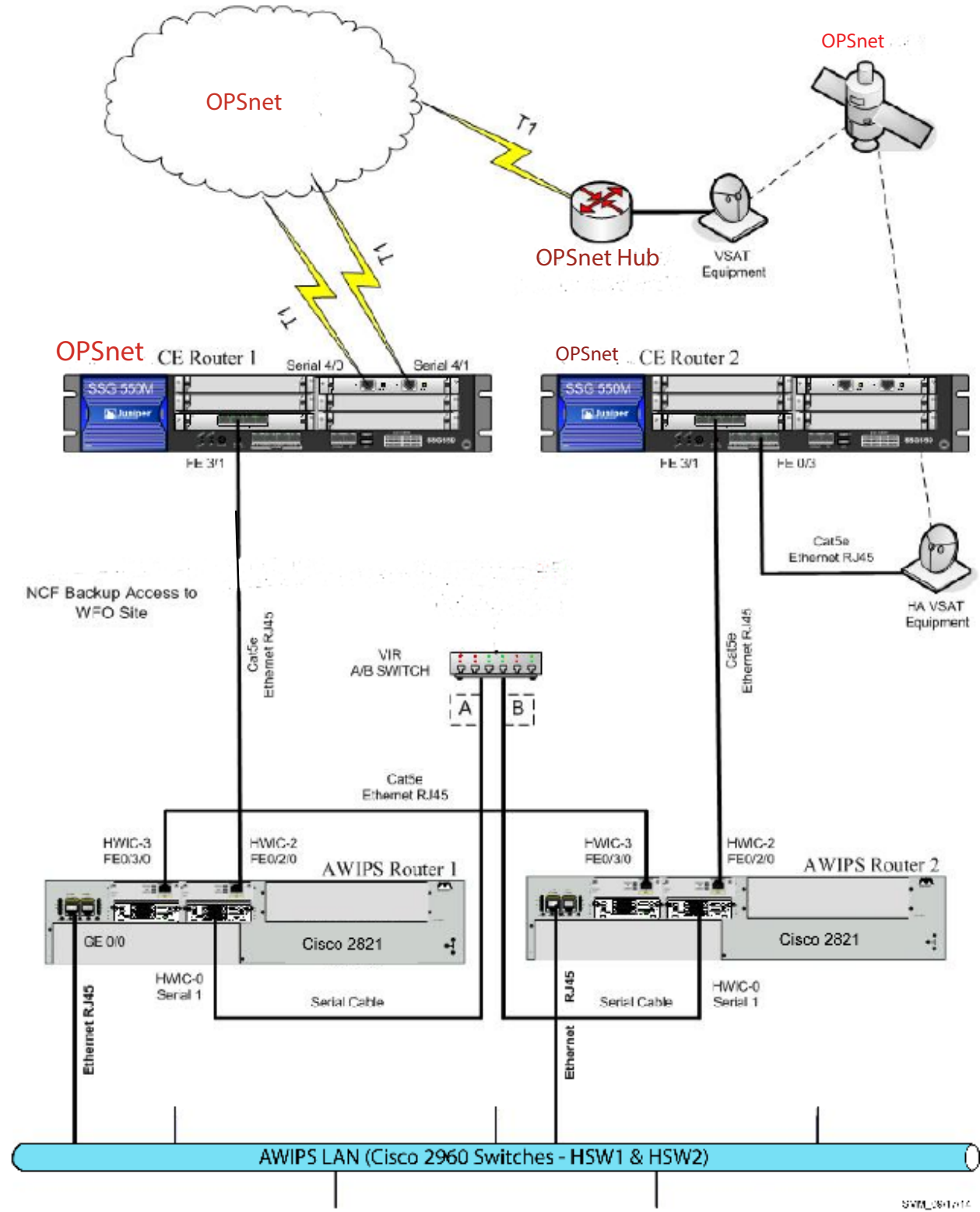
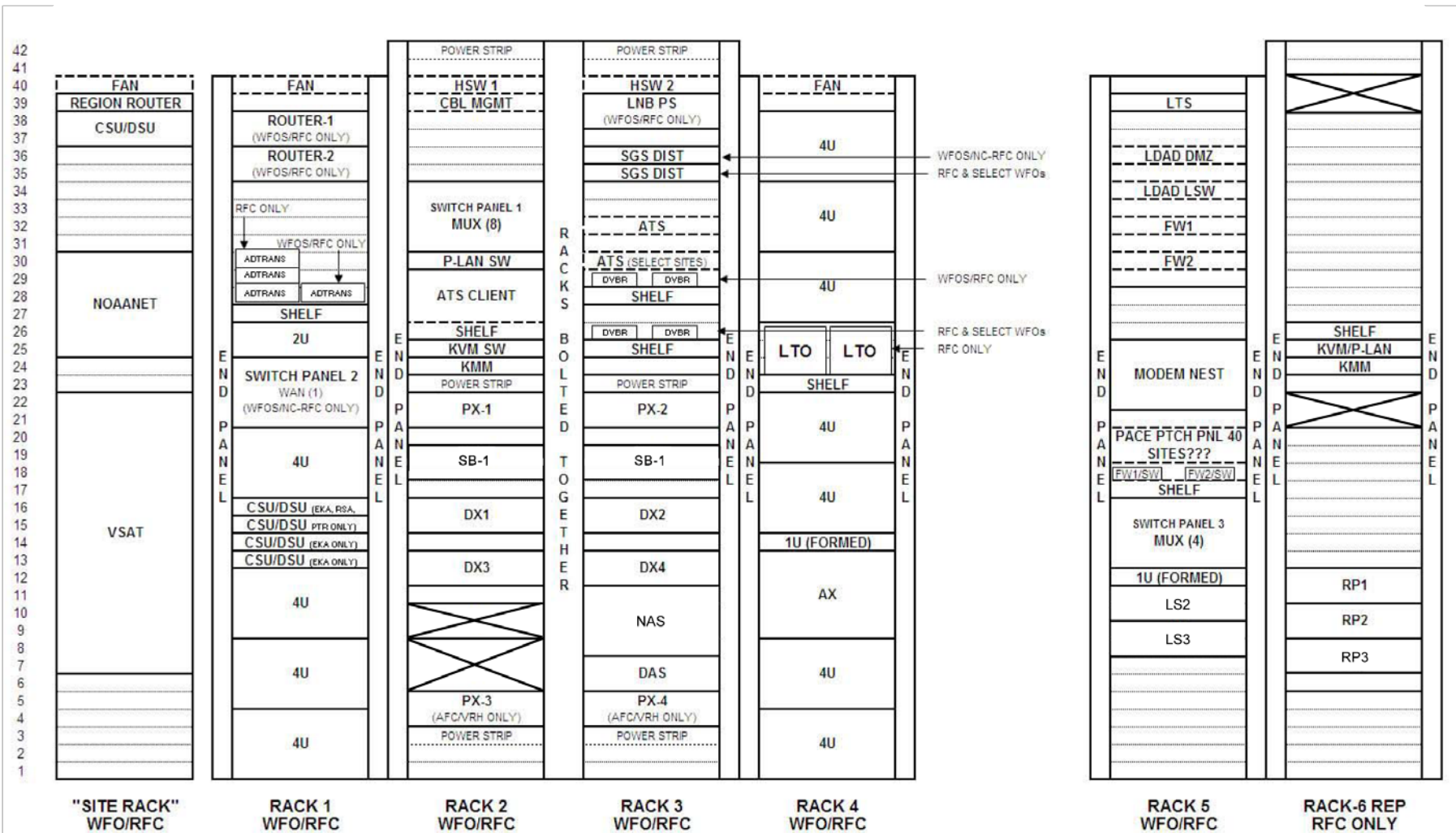

Exhibit 2.2-4. AWIPS WFO Network Diagram



SMM\_09/17/14

Exhibit 2.2.1-1. Standard Stand-Alone WFO/RFC Rack Configuration

### 2.2.1.1 *Satellite Broadcast Network (SBN)*

The Communications Processors for the SBN (Communications Processors - Satellite Broadcast Network [CPSBN]) accept data from the DVB receivers, separate the individual products from the data stream, and transfer the products to the Linux data servers for additional processing.

- **DVB Receivers**

Each AWIPS site has two DVB receivers that receive SBN data. Each DVB receiver receives all of the SBN data transmitted to the site and each receiver acts as a backup for the other. The DVB receivers replaced the demodulators, and the demodulators have been removed from the AWIPS hardware rack. The DVB receiver output is a dedicated LAN segment directly connected to the associated CPSBN.

- **Satellite Broadcast Processors**

At each AWIPS site, there are two CPSBNs responsible for receiving GOES products and a combination of NCEP products from the NCF.

**NOTE:** No site has more than two CPSBNs unless it has an NRS.

CPSBN1 and CPSBN2 function as a heartbeat cluster; failover is managed automatically or manually. Note that only a single high-availability package is currently used on this cluster. The package name is a2cp1apps (AWIPS II only). In failover mode, package execution shifts to the backup server. LDM is controlled by the a2cp1apps package.

The a2cp1apps package manages the cp1f floating server name. Note that floating names are available only when the high-availability packages are running; they cannot be used to start or stop the high-availability packages.

Each CPSBN is an HP DL380 G6 server with a dual 2.26 GHz E5520 processor, 6 GB of RAM, and 4 Ethernet LAN ports. The CPSBN memory will be upgraded to 12 GB with DX1/2 upgrade.

IP Virtual Server is installed on the CPSBNs. IPVS acts as a load balancer at the front of the DX3/DX4 EDEX cluster real servers; it directs requests from the workstations for TCP/UDP-based services to the real servers, and makes services of the real servers appear to the workstations as a virtual service on a single IP address. IPVS is aliased as ec. Clients such as CAVE (Common AWIPS Visualization Environment) connect to the EDEX server via the ec alias; this provides for continuation of service in the event of system failover.

Queue Processor Interface Daemon (QPID) is a JVM (Java Virtual Machine) message broker configured to run on the CPSBN machines. It is responsible for keeping a queue of messages sent by ingest processes alerting an EDEX cluster of new or available data. Each EDEX process in an EDEX cluster is responsible for retrieving

the next product in the queue, deleting that product from the queue, and acting upon the data product based on the information inside the JVM message. In this respect, it works on a first-come-first-serve basis. So the EDEX process that has the most system resources available and is processing most quickly will, in theory, get to more products before the others. A monitoring script has been added and a cron has been set up in `a2cp1cron`, which will collect `qpid` stats and keep a week's worth of data in `/data/fxa/qpid`.

The major file systems on the CPSBNs are:

- **root (/), /tmp, /usr, /var.** Linux mandates that these file systems exist. They are maintained as separate logical volumes to reduce the risk of any of these file systems filling up and affecting system operations. All of the file systems are ext3. The `/tmp` file system will be re-created with each boot sequence and performs no journaling.
- **/boot.** This file system is used to store the Linux kernel and boot-up instructions.
- **/dev/shm.** This is the designated shared memory.
- **/home.** This file system contains the entire user working areas.
- **/awips.** This file system is used to store baselined software and any associated log or configuration files. It may contain binary applications, scripts, logs, or data as required to support operations.
- **/data.** This file system is used to store the data received over the SBN and also the acquisition and SBN process logs. Subdirectories will further isolate application- or product-specific logs.
- **/awips2.** This file system is used to store baselined AWIPS II software.
- **/data/fxa.** This file system stores AWIPS data products that are not maintained within the RDBMS. This would include the LDAD data.
- **/data\_store.** Folders are usually laid out exactly like the `sbns` folders on the EDEX server, with each plug-in having a folder on the data store. However, some of them do not follow the same convention; for example, data sent to the 'metar' endpoint will be found in the `/data_store/text` folder. See Chapter 6 for more details on other data types. Additionally, if new format ingest is being worked, you will find new data types not yet found on the development or integration systems. Those files will be located in `/data_store/experimental`.

```
[root@cpsbn2-bcq ~]# df -H
```

The following example illustrates CPSBN mount points for the WFOs.

Filesystem	Size	Used	Avail	Use%	Mounted on
<code>/dev/mapper/vg00-lvol01</code>	1.1G	544M	420M	57%	<code>/</code>
<code>tmpfs</code>	17G	4.1k	17G	1%	<code>/dev/shm</code>
<code>/dev/mapper/vg00-lvol_awips</code>	512M	248M	237M	52%	<code>/awips</code>
<code>/dev/mapper/vg00-lvol_awips2</code>	5.1G	1.9G	3.0G	40%	<code>/awips2</code>
<code>/dev/sda1</code>	199M	38M	152M	20%	<code>/boot</code>
<code>/dev/mapper/vg00-lvol_data</code>	87G	3.4G	79G	5%	<code>/data</code>

```

/dev/mapper/vg00-lvol_home    252M  3.5M  235M   2% /home
/dev/mapper/vg00-lvol_tmp    512M  5.6M  480M   2% /tmp
/dev/mapper/vg00-lvol_usr    16G   6.3G  8.3G  44% /usr
/dev/mapper/vg00-lvol_var    3.1G  640M  2.3G  23% /var
nas1:/dataFXA                537G  355G  183G  66% /data/fxa
nas1:/awips2REPO             43G   14G   30G  32% /data/fxa/INST
nas1:/aiidata                537G   61G  477G  12% /awips2/edex/d
nas2:/dataSTORE              2.2T  1.1T  1.2T  47% /data_store
nas2:/awips2ARCHIVE          3.3T  850G  2.5T  26% /archive
nas1:/qpid                   11G   1.6G  9.2G  15% /awips2/qpid/e

```

```
[root@cpsbn1-tbdr ~]# df -H
```

The following example illustrates CPSBN mount points for the RFCs.

```

Filesystem      Size  Used Avail Use% Mounted on
Filesystem      Size  Used Avail Use% Mounted on
/dev/mapper/vg01-lvol01  1.1G  616M  348M  64% /
tmpfs           6.3G  4.1k  6.3G   1% /dev/shm
/dev/mapper/vg01-lvol_awips 512M  142M  344M  30% /awips
/dev/mapper/vg01-lvol_awips2 5.1G  3.4G  1.5G  70% /awips2
/dev/sda3       199M   66M  123M  35% /boot
/dev/mapper/vg01-lvol_home 252M  2.8M  236M   2% /home
/dev/mapper/vg01-lvol_tmp  512M  5.0M  480M   2% /tmp
/dev/mapper/vg01-lvol_usr  16G   6.6G  8.1G  45% /usr
/dev/mapper/vg01-lvol_var  3.1G  910M  2.0G  32% /var
/dev/mapper/vg00-lvol_data  87G   7.1G   76G   9% /data
nas1:/dataFXA        537G  378G  160G  71% /data/fxa
nas1:/aiidata        537G  264G  274G  50% /awips2/edex/data
nas1:/dataSTORE      537G  170G  368G  32% /data_store
nas1:/awips2REPO     43G   7.2G   36G  17%
                               /data/fxa/INSTALL/awips2
nas1:/qpid           11G   331M   11G   4%
                               /awips2/qpid/edexMessageStor

```

### 2.2.1.2 Synchronous Communications

- **Switch Panel**

The switch panel provides redundant, remotely controllable communications interfaces for the PX asynchronous multiplexers (mux). Specifically, the switch panel switches incoming and outgoing signals from the primary to the spare PX mux or ports when directed. The switch panel is controlled locally by the AWIPS Terminal Server and remotely from the NCF through the AWIPS Terminal Server. The switch panel provides a passive patch capability for each communications line. This allows communications problems to be monitored and diagnosed without disconnecting any communications equipment.

The VIR switches provide the ability to switch between primary and backup equipment. The switches may be operated remotely (by the NCF) or manually at the site (by the system managers). There are redundant connections and pathways to all AWIPS hardware except between the antenna and the DVB receivers (there is only one IFL).



- **Modem Nest**

AWIPS accommodates a variety of site-specific communications requirements through a high-reliability rack-mounted Modem Nest with redundant power supplies. The Modem Nest supports up to 16 single modem cards. Every site has either a 10-modem-card modem nest or a 16-modem-card modem nest.

### 2.2.1.3 *Application Server*

Application servers have been decommissioned at all sites except the NCF.

### 2.2.1.4 *Data Servers*

The data server systems support the functions for processing, archiving, and retrieval. The processing and storage functions receive and store data that were acquired and distributed via the multiple CPs and service data requests to all workstations. The archiving functions provide general capabilities for retrieving site archive data, storing data in the site archive (both automatic and requested storage), and retrieving data from the site archive. The data server hardware components are the DX (1-4) servers, the archive servers (WAX and RAX), and the network attached storage (NAS).

- **Data Server Processors**

Four Linux-based DX servers (two primary and two secondary) are deployed at every AWIPS site. The DXs provide the centralized computing and centralized database functions. They support the processing required to store and process many types of data and products that are acquired, derived, or manually entered. They also store software, map backgrounds, and site-specific data.

The PostgreSQL object-relational database management system is supported by Network Appliance (NetApp) FAS2020C rack-mounted mass storage. These devices are direct-connected to DL380G6 Linux Data Servers (DX1 and DX2). Refer to Appendix E, Mass Storage Design, for a description of the disk allocations.

DX1 and DX2 function as a heartbeat cluster; failover is managed automatically or manually. Note that both DX1 and DX2 normally run separate high-availability packages: a2dx1apps on DX1 and a2dx2apps on DX2. In failover mode, both packages shift to the same server. Access to DX1 and DX2 is via server name alias: dx1f points to the server running the a2dx1apps package; dx2f points to the server running the a2dx2apps package. Note that the floating names are available only when the high-availability packages are running; they cannot be used to start or stop the high-availability packages.

DX3 and DX4 are independent servers, both of which run the EDEX server software. There is no failover between DX3 and DX4. Both servers are load balanced and share data processing responsibilities; if one server is stopped, the other will pick up the entire data processing load. Processing load balancing between DX3 and DX4 is

provided by QPID as data messages are removed from QPID queues and processed by the EDEX instance having available processing capacity. Client request balancing for DX3 and DX4 is managed by Internet Protocol Virtual Server (IPVS) (the pulse service). Both QPID and IPVS run on CPSBN1 and CPSBN2.

Additional information on IPVS, including monitoring tools, is provided in Chapter 25, AWIPS II/EDEX Administration Guide. The DX configurations are summarized in Table 2.2.1.4-1. Each Linux DX is connected to the Gigabit LAN.

**Table 2.2.1.4-1. Data Server Configurations at AWIPS Sites**

Type	Site	Processor	RAM	CACHE	Internal Storage
HP DL380 G6	All Sites (DX server)	2x2.26 GHz Xeon CPU	12 GB	1 MB L2 cache	2x146 GB
HP DL380 G8 (FY 15)		Quad Core			
Dell PowerEdge 2950	All AWIPS Sites	Dual Quad Core 2.33 GHz	8 GB SDRAM	6 MB	2X 146 GB

- **River Ensemble Processors (REP)**

The River Ensemble Processor (REP) suite, part of the NWS' Advanced Hydrologic Prediction Service (AHPS) program, was designed as a high-performance “blank slate” on which the River Forecast Centers can load new or site-modified applications in an environment that is very similar to AWIPS. It includes an availability infrastructure that allows failing-over of processes and crons if desired. This hardware hosts “baseline” Office of Hydrology (OH) applications implemented via AWIPS or AHPS, as appropriate. The REP provides the RFCs with a platform that was designed for easy expansion based on mission requirements. The REP suite is a self-contained unit that includes a rack, three commodity servers. The REP was preconfigured, including IP addresses, to facilitate installation and allow the RFCs to take advantage of the additional processing power as soon as desired. The three Linux Operating System commodity servers have a file system structure that is consistent with current operations.

The REP NAS provides storage at the RFCs for the hydrologic data for the prediction models run on the REP processors. The RFC NAS Sun STK5320 has been replaced with the NetApp filer also known as NetApp's network attached storage (NAS) device, or NetApp FAS2240-4. The REP shares are all hosted by the nas2 controller, whereas the default AWIPS shares are hosted by controller nas1. Both NAS1 and NAS2 are contained within the same chassis. There is no extra controller node in the RP rack after the replacement.

- **WFO Archive Server**

The WFO AX (WAX) (DS1E) is a Linux-based device, currently used only for tape backup. It runs the weekly nas backup script because the tape device is connected to it.

The WAX configurations are summarized in Table 2.2.1.4-2.

**Table 2.2.1.4-2. WFO Archive Server Configuration at AWIPS Sites**

Type	Site	Processor	RAM	CACHE	Internal Storage
HP ML350	Stand-alone WFOs and Collocated WFOs	1X Dual Core 2.66 GHz CPU	1 GB	512 KB	3X 146 GB

An RS-232-C interface connects the WAX processor console port to the site CP/monitor and control interface for monitor control.

- **RFC Archive Server**

The RFC AX (RAX) (DS1E) is a Linux-based device dedicated to providing additional disk storage capacity and processing power for hydrologic data. The server hosts Postgres and has the processing power and associated software to process large collections of hydrologic data. It is not a redundant server; however, it does have an SCSI RAID Level 5 storage array. It also has a DVD/CDR, and data can be selected and moved to more permanent storage or written to a CD or DVD.

The RAX configurations are summarized in Table 2.2.1.4-3.

**Table 2.2.1.4-3. RFC Archive Server Configuration at AWIPS Sites**

Type	Site	Processor	RAM	CACHE	Internal Storage
HP ML350	RFCs	1X Dual Core 2.66 GHz CPU	4 GB	512 KB	6X 146 GB

An RS-232-C interface connects the RAX processor console port to the site CP/monitor and control interface for monitor control.

- **Network Attached Storage**

The NAS (DS1F) NetApp filer also known as NetApp's network attached storage (NAS) device provides storage at AWIPS sites and at the RFCs, storage for REP hydrologic data as well.

- **Archive Storage**

A portable 1 TB Hard Disk Drive (HDD) with eSATA interface to the Archive Server has been added to the Archive Storage system, a prerequisite for AWIPS II. The DX and REP Tape Drive's FibreBridge connection has been removed; the tape drive is now directly connected to the Archive Server via the LVD SCSI interface.

#### **2.2.1.4.1 Data Server File Systems and Raw Partitions**

The DX file systems support the following:

- Operating system
- COTS applications

- Developed applications.

#### 2.2.1.4.1.1 *File Systems on the Linux Data Server (DX)*

The major file systems on the Linux-OS DXs are:

- **root ( / ), /tmp, /usr, /var.** Linux mandates that these file systems exist.
- **/boot.** This file system contains the Linux kernel and boot-up instructions.
- **/dev/shm.** This file system is the Linux shared memory.
- **/awips/fxa.** This file system stores baselined Forecast Systems Laboratory (FSL)-developed (presently Earth System Research Laboratory/Global Systems Division (ESRL/GSD)) WFO-Advanced software and any associated log or configuration files. It may contain binary applications, scripts, logs, or data that are required to support operations.
- **/awips/ifps.** This file system is for baselined IFPS software and data.
- **/awips/ldad.** This file system contains scripts and data for LDAD server.
- **/awips/ops.** This file system stores baselined contractor-developed software and any associated log or configuration files. It may contain binary applications, scripts, logs, or data as required to support the operations.
- **/data/logs.** This file system contains the operational logs for software executing on the platform. Subdirectories will further isolate application- or product-specific logs.
- **/awips2.** This file system is used to store base-lined AWIPS II software.
- **/awips2/data.** Contains database files (only on DX1/2)
- **/awips2/edex/data/hdf5.** On DX1/2: contains the HDF5 component of the data store. On DX3/4, LX, and XT workstations: contains shared static data and hydro apps.

The following directory is mounted on the DXs from the NAS:

- **/data\_store.** Folders are usually laid out exactly like the sbn folders on the EDEX server with each plug-in having a folder on the data store. But some of them do not follow the same convention, for e.g., data sent to the 'metar' endpoint will be found in the /data\_store/text folder. See Chapter 6 for more details on other data types. Additionally, if new format ingest is being worked, you will also find new data types not yet found on the development or integration systems. Those files will be located in /data\_store/experimental.

The following directories are also mounted on the DX:

- **/awips/dev.** This file system contains the source code and libraries required for local software development at field sites. The /awips/dev file system is NFS-exported to support development from the workstations.

- **/awips/adapt.** This file system contains the AWIPS Decision Assistance Production Preparation Tools (ADAPPT) software for the most recent software installation at WFO sites. This includes the Hourly Weather Roundup (HWR), Climate, the Interactive Forecast Preparation System (IFPS), the Local AWIPS Model Output Statistics (MOS) Program (LAMP), and Pre-LAMP software. This file system may contain binary applications, scripts, logs, or data.
- **/awips/GFESuite.** This file system contains the GFESuite software. This file system may contain binary applications, scripts, logs, or data.
- **/awips/hydroapps.** This file system contains the NWS WFO Hydrologic Forecast System (HFS) and NWS River Forecast System (NWSRFS) baseline software for the most recent software installation.
- **/awips/ops.** This file system stores baselined contractor-developed software and any associated log or configuration files. It may contain binary applications, scripts, logs, or data as required to support the operations.
- **/awips/rep.** This file system (RFCs only) is mounted from the secondary NAS(NS1) and is used for REP.
- **/data/fxa.** This file system stores AWIPS data products that are not maintained within the RDBMS. This would include the LDAD data.
- **/data/GFE.** This file system (WFOs only) stores the GFESuite data products.
- **/awips/db.** This file system stores database software.
- **/data/local.** This file system contains locally acquired or site-specific data and is the file system that sites should use to store locally developed software. Each site specifies what is included in this file system, so it may contain binary applications, scripts, logs, or data.
- **/data/x400.** This directory contains the Message Handling System (MHS) files.
- **/data/adapt.** This file system (WFOs only) contains the IFPS, GFESuite, and LAMP data, including GIF and text file products, topographic maps, shapefiles, IFPS database grids and maps, and GFESuite databases, products, and topographic maps at WFO sites.
- **/home.** This file system contains all the user working areas.
- **/DS\_shared.** This directory contains the GNU compiler collection, an obsolete logs directory, an MHS directory that is still in use and an obsolete HP service Guard Directory.
- **/awips2.** This file system is used to store baselined AWIPS II software.
- **/awips/storage.** A location for the storage of miscellaneous AWIPS related files.
- **/awips2/GFESuite.** Contains scripts and data relating to inter site coordination (ISC) and service backup.
- **/awips2/edex/data/utility.** Contains localization store and EDEX configuration files.

An example of mount points for a dx3/4 at the WFOs follows.

```
[root@dx3-tbdw ~]# df -H
```

Filesystem	Size	Used	Avail	Use%	Mounted on
/dev/mapper/vg00-lvol_root	1.1G	680M	361M	66%	/
tmpfs	17G	0	17G	0%	/dev/shm
/dev/mapper/vg00-lvol_fxa	5.3G	1.1G	4.0G	22%	/awips/fxa
/dev/mapper/vg00-lvol_ifps	1.4G	49M	1.2G	4%	/awips/ifps
/dev/mapper/vg00-lvol_ldad	1.1G	127M	837M	14%	/awips/ldad
/dev/mapper/vg00-lvol_ops	276M	126M	137M	48%	/awips/ops
/dev/mapper/vg00-lvol_awips2	41G	18G	21G	47%	/awips2
/dev/sdal	500M	39M	436M	9%	/boot
/dev/mapper/vg00-lvol_logs	2.1G	4.6M	2.0G	1%	/data/logs
/dev/mapper/vg00-lvol_tmp	1.1G	2.5M	961M	1%	/tmp
/dev/mapper/vg00-lvol_usr	11G	8.1G	1.7G	84%	/usr
/dev/mapper/vg00-lvol_var	3.1G	596M	2.3G	21%	/var
nas1:/awipsADAPT	1.1G	730M	345M	68%	/awips/adapt
nas1:/awipsDEV	4.3G	132k	4.3G	1%	/awips/dev
nas1:/awipsGFESuit	108G	19G	89G	18%	/awips/GFESuite
nas1:/awipsHYDRO	108G	866M	107G	1%	/awips/hydroapps
nas1:/dataLOCAL	162G	55G	107G	34%	/data/local
nas1:/dataX400	630M	228M	402M	37%	/data/x400
nas1:/DSshared	1.1G	410M	664M	39%	/DS_shared
nas1:/dataADAPT	3.3G	0	3.3G	0%	/data/adapt
nas1:/dataGFE	21M	0	21M	0%	/data/GFE
nas1:/awipsHOME	119G	83G	37G	70%	/home
nas1:/dataFXA	537G	355G	183G	66%	/data/fxa
nas1:/aiidata	537G	61G	477G	12%	/awips2/edex/data
nas1:/localapps	54G	107M	54G	1%	/localapps
nas2:/dataSTORE	2.2T	1.1T	1.2T	47%	/data_store
nas2:/awips2ARCHIVE	3.3T	850G	2.5T	26%	/archive
nas1:/awips2REPO	43G	14G	30G	32%	
/data/fxa/INSTALL/awips2					
nas1:/GFESuite2	11G	2.1G	8.7G	20%	/awips2/GFESuite

An example of mount points for a dx3/4 at the RFCs follows.

```
[root@dx3-tbdr ~]# df -H
```

Filesystem	Size	Used	Avail	Use%	Mounted on
/dev/mapper/vg00-lvol_root	1.1G	680M	361M	66%	/
tmpfs	17G	0	17G	0%	/dev/shm
/dev/mapper/vg00-lvol_fxa	5.3G	1.1G	4.0G	22%	/awips/fxa
/dev/mapper/vg00-lvol_ifps	1.4G	49M	1.2G	4%	/awips/ifps
/dev/mapper/vg00-lvol_ldad	1.1G	127M	837M	14%	/awips/ldad
/dev/mapper/vg00-lvol_ops	276M	126M	137M	48%	/awips/ops
/dev/mapper/vg00-lvol_awips2	41G	18G	21G	47%	/awips2
/dev/sdal	500M	39M	436M	9%	/boot
/dev/mapper/vg00-lvol_logs	2.1G	4.6M	2.0G	1%	/data/logs
/dev/mapper/vg00-lvol_tmp	1.1G	2.5M	961M	1%	/tmp
/dev/mapper/vg00-lvol_usr	11G	8.1G	1.7G	84%	/usr
/dev/mapper/vg00-lvol_var	3.1G	596M	2.3G	21%	/var
nas1:/awipsADAPT	1.1G	730M	345M	68%	/awips/adapt
nas1:/awipsDEV	4.3G	132k	4.3G	1%	/awips/dev
nas1:/awipsGFESuit	108G	19G	89G	18%	/awips/GFESuite
nas1:/awipsHYDRO	108G	866M	107G	1%	/awips/hydroapps
nas1:/dataLOCAL	162G	55G	107G	34%	/data/local
nas1:/dataX400	630M	228M	402M	37%	/data/x400
nas1:/DSshared	1.1G	410M	664M	39%	/DS_shared
nas1:/dataADAPT	3.3G	0	3.3G	0%	/data/adapt

```

nas1:/dataGFE                21M      0    21M    0% /data/GFE
nas1:/awipsHOME              119G    83G   37G   70% /home
nas1:/dataFXA                537G   355G  183G  66% /data/fxa
nas1:/aiidata                537G    61G  477G  12% /awips2/edex/data
nas1:/localapps              54G   107M   54G    1% /localapps
nas2:/dataSTORE              2.2T   1.1T   1.2T  47% /data_store
nas2:/awips2ARCHIVE          3.3T   850G   2.5T  26% /archive
nas1:/awips2REPO             43G    14G    30G  32%
/data/fxa/INSTALL/awips2
nas1:/GFESuite2              11G    2.1G   8.7G  20% /awips2/GFESuite

```

```
[root@dx1-bcq ~]# df -H
```

An illustration of the mount points for a WFO DX1/2 follows.

```

Filesystem                Size  Used Avail Use% Mounted on
/dev/mapper/vg01-lvol01  1.1G  830M  134M  87% /
tmpfs                      17G    0    17G    0% /dev/shm
/dev/mapper/vg01-lvol_fxa  5.1G  1.6G  3.2G  34% /awips/fxa
/dev/mapper/vg01-lvol_ifps  1.4G   49M  1.2G   4% /awips/ifps
/dev/mapper/vg01-lvol_ldad  1.1G   67M  897M   7% /awips/ldad
/dev/mapper/vg01-lvol_ops  297M  244M   37M  87% /awips/ops
/dev/mapper/vg01-lvol_awips2 34G   2.5G   30G   8% /awips2
/dev/sde3                  98M   75M   18M  81% /boot
/dev/mapper/vg01-lvol_logs  11G   25M   9.9G   1% /data/logs
/dev/mapper/vg01-lvol_tmp  1.1G   36M   928M   4% /tmp
/dev/mapper/vg01-lvol_usr   11G   8.4G   1.4G  87% /usr
/dev/mapper/vg01-lvol_var   3.6G   2.8G  582M  83% /var
nas1:/awipsADAPT           1.1G  733M  342M  69% /awips/adapt
nas1:/awipsDEV             4.3G  132k   4.3G   1% /awips/dev
nas1:/awipsGFESuite       108G   19G   89G  18% /awips/GFESuite
nas1:/awipsHYDRO          108G  902M  107G   1% /awips/hydroapps
nas1:/dataLOCAL           162G   56G  106G  35% /data/local
nas1:/dataX400            630M  228M  402M  37% /data/x400
nas1:/DSshared            1.1G  410M  664M  39% /DS_shared
nas1:/dataADAPT           3.3G    0    3.3G   0% /data/adapt
nas1:/dataGFE              21M    0    21M   0% /data/GFE
nas1:/awipsHOME           119G   88G   32G  74% /home
nas1:/dataFXA             537G  462G   76G  86% /data/fxa
nas1:/aiidata/utility      537G   67G  471G  13%
/awips2/edex/data/utility
nas1:/GFESuite2           11G   3.6G   7.2G  34% /awips2/GFESuite
nas1:/localapps           54G  426M   54G   1% /localapps
nas2:/dataSTORE           2.2T  188G   2.1T   9% /data_store
nas2:/awips2ARCHIVE       3.3T   18G   3.3T   1% /archive
nas1:/awips2REPO          43G   35G   8.9G  80%
/data/fxa/INSTALL/awips2
nas1:/storage             537G  264G  274G  50% /awips/storage
nas1:/awipscm             269G  104G  166G  39% /awipscm
/dev/mapper/vg_aaidb-awipsiadb 159G   18G  134G  12% /awips2/data

```

An illustration of the mount points for a RFC DX1/2 follows.

```
[root@dx2-tbdr ~]# df -H
```

```

Filesystem                Size  Used Avail Use% Mounted on
/dev/mapper/vg01-lvol01  1.1G  744M  220M  78% /
tmpfs                      17G    0    17G    0% /dev/shm
/dev/mapper/vg01-lvol_fxa  5.1G  1.6G  3.2G  34% /awips/fxa

```

/dev/mapper/vg01-lvol_ifps	1.4G	49M	1.2G	4%	/awips/ifps
/dev/mapper/vg01-lvol_ldad	1.1G	67M	897M	7%	/awips/ldad
/dev/mapper/vg01-lvol_ops	297M	147M	134M	53%	/awips/ops
/dev/mapper/vg01-lvol_awips2	34G	2.6G	30G	8%	/awips2
/dev/sde3	98M	63M	30M	69%	/boot
/dev/mapper/vg01-lvol_logs	11G	25M	9.9G	1%	/data/logs
/dev/mapper/vg01-lvol_tmp	1.1G	32M	932M	4%	/tmp
/dev/mapper/vg01-lvol_usr	11G	8.0G	1.7G	83%	/usr
/dev/mapper/vg01-lvol_var	3.6G	2.1G	1.3G	63%	/var
nas1:/awipsADAPT	1.1G	730M	345M	68%	/awips/adapt
nas1:/awipsDEV	4.3G	132k	4.3G	1%	/awips/dev
nas1:/awipsGFESuit	108G	19G	89G	18%	/awips/GFESuite
nas1:/awipsHYDRO	108G	866M	107G	1%	/awips/hydroapps
nas1:/dataLOCAL	162G	55G	107G	34%	/data/local
nas1:/dataX400	630M	228M	402M	37%	/data/x400
nas1:/DSshared	1.1G	410M	664M	39%	/DS_shared
nas1:/dataADAPT	3.3G	0	3.3G	0%	/data/adapt
nas1:/dataGFE	21M	0	21M	0%	/data/GFE
nas1:/awipsHOME	119G	83G	37G	70%	/home
nas1:/dataFXA	537G	355G	183G	66%	/data/fxa
nas1:/aiidata/utility	537G	61G	477G	12%	
/awips2/edex/data/utility					
nas1:/localapps	54G	107M	54G	1%	/localapps
nas2:/dataSTORE	2.2T	1.1T	1.2T	47%	/data_store
nas2:/awips2ARCHIVE	3.3T	850G	2.5T	26%	/archive
nas1:/awips2REPO	43G	14G	30G	32%	
/data/fxa/INSTALL/awips2					
nas1:/storage	537G	475G	63G	89%	/awips/storage
nas1:/awipscm	269G	55G	215G	21%	/awipscm
/dev/mapper/vg_aaidb-awipsiadb	159G	14G	137G	10%	/awips2/data
nas1:/GFESuite2					

### 2.2.1.4.1.2 Raw Partitions for PostgreSQL on the Linux Data Server

The raw partition for PostgreSQL on the DX is mounted to the dx1f device from the FAS2020 Direct Attached Storage Device.

The following is an example of the PostgreSQL mount point on the dx1f.

```
[root@dx1- ~]# df -H /awips2/data
```

Filesystem	Size	Used	Avail	Use%	Mounted on
/dev/mapper/vg_aaidb-awipsiadb	159G	42G	110G	28%	/awips2/data

```
[root@dx2-tbdr ~]# df -H /awips2/data
```

Filesystem	Size	Used	Avail	Use%	Mounted on
/dev/mapper/vg_aaidb-awipsiadb	159G	27G	124G	18%	/awips2/data

### 2.2.1.4.2 AX File Systems

The AX file systems support the following:

- Operating system



- COTS applications
- Developed applications
- Archived Data.

The major file systems on the AX for WFO and RFC are as follows:

- **root( / ), /tmp, /usr, /var.** Linux mandates that these file systems exist.
- **/boot.** This file system contains the Linux kernel and boot-up instructions.
- **/awips/archiver.** This file system stores the archiver data. It contains scripts, logs, configuration files, and documentation.
- **/local.** This file system contains scripts and logs related to the installation of AWIPS software.
- **/data.** This file system contains the archiver (5-day rollover and compressed) and local radar data.
- **/dev/shm.** This file system is the Linux shared memory input queue.
- **/awips/ops.** This file system stores baselined software and any associated log or configuration files. It may contain binary applications, scripts, logs, or data as required to support operations.
- **/awips/fxa.** This file system stores baselined FSL-developed (presently ESRL/GSD) WFO-Advanced software and any associated log or configuration files. It may contain binary applications, scripts, logs, or data, as required to support operations.
- **RFC Mount Points**
  - **/rfc\_arc.** This file system is at RFCs only and may contain binary applications, scripts, logs or data for RFC hydrological operations.
  - **/rfc\_arc\_data.** This file system is at RFCs only and contains flat files of archived hydrological data and products for RFC hydrological operations.
- **NFS Mount Points**
  - The following directory is mounted by the AX server from the NAS in support of AWIPS functions.
    - **/data\_store**
  - The following directories are mounted by the AX server from the NAS in support of AWIPS functions.
    - **/data/fxa**
    - **/data/local**
    - **/home**
- **RFCs only**
  - **/awips/rep**
  - **/awips/hydroapps**
  - **/home**

Refer to Chapter 24, Data Archive Server, for additional information.

An example of mount points for a WFO AX follows.

```
[root@ax-tbdw ~]# df -H
/dev/mapper/vg01-lvol01      1.1G 565M 406M 59% /
tmpfs                       522M  0 522M  0% /dev/shm
/dev/mapper/vg01-lvol_archiver 1.1G  22M 950M  3% /awips/archiver
/dev/mapper/vg01-lvol_fxa    1.1G 635M 336M 66% /awips/fxa
/dev/mapper/vg01-lvol_ops    301M  56M 229M 20% /awips/ops
/dev/cciss/c0d0p1           98M  54M  39M 58% /boot
/dev/mapper/vg01-lvol_local  2.1G  3.1M 2.0G  1% /local
/dev/mapper/vg01-lvol_tmp    512M 443k 485M  1% /tmp
/dev/mapper/vg01-lvol_usr    16G  7.6G 7.1G 52% /usr
/dev/mapper/vg01-lvol_var    3.1G  1.6G 1.4G 53% /var
/dev/mapper/vg00-lvol_data   235G  63M 223G  1% /data
nas1:/dataFXA               537G 373G 165G 70% /data/fxa
nas1:/dataLOCAL             162G  56G 106G 35% /data/local
nas1:/awipsHOME             119G  82G  37G 69% /home
nas1:/awipsADAPT            1.1G 732M 343M 69% /awips/adapt
nas1:/aiidata/utility       537G  65G 473G 13%
/awips2/edex/data/utility
nas2:/dataSTORE             2.2T 119G 2.1T  6% /data_store
nas2:/awips2ARCHIVE        3.3T 4.8G 3.3T  1% /archive
nas1:/awips2REPO            43G  23G  21G 53%
/data/fxa/INSTALL/awips2
/dev/sda1                   8.1G  1.5G  6.3G 19% /media/flash
nas-tape:/awipsHOME         119G  82G  37G 69% /tmp/home
nas-tape:/awipsADAPT        1.1G 732M 343M 69% /tmp/awips/adapt
```

An example of mount points for a RFC AX follows.

```
[root@ax-tbdr ~]# df -H
/dev/mapper/vg01-lvol01      1.1G 565M 406M 59% /
tmpfs                       522M  0 522M  0% /dev/shm
/dev/mapper/vg01-lvol_archiver 1.1G  22M 950M  3% /awips/archiver
/dev/mapper/vg01-lvol_fxa    1.1G 635M 336M 66% /awips/fxa
/dev/mapper/vg01-lvol_ops    301M  56M 229M 20% /awips/ops
/dev/cciss/c0d0p1           98M  54M  39M 58% /boot
/dev/mapper/vg01-lvol_local  2.1G  3.1M 2.0G  1% /local
/dev/mapper/vg01-lvol_tmp    512M 443k 485M  1% /tmp
/dev/mapper/vg01-lvol_usr    16G  7.6G 7.1G 52% /usr
/dev/mapper/vg01-lvol_var    3.1G  1.6G 1.4G 53% /var
/dev/mapper/vg00-lvol_data   235G  63M 223G  1% /data
nas1:/dataFXA               537G 373G 165G 70% /data/fxa
nas1:/dataLOCAL             162G  56G 106G 35% /data/local
nas1:/awipsHOME             119G  82G  37G 69% /home
nas1:/awipsADAPT            1.1G 732M 343M 69% /awips/adapt
nas1:/aiidata/utility       537G  65G 473G 13%
/awips2/edex/data/utility
nas2:/dataSTORE             2.2T 119G 2.1T  6% /data_store
nas2:/awips2ARCHIVE        3.3T 4.8G 3.3T  1% /archive
nas1:/awips2REPO            43G  23G  21G 53%
/data/fxa/INSTALL/awips2
/dev/sda1                   8.1G  1.5G  6.3G 19% /media/flash
nas-tape:/awipsHOME         119G  82G  37G 69% /tmp/home
nas-tape:/awipsADAPT        1.1G 732M 343M 69% /tmp/awips/adapt
```

### 2.2.1.5 LDAD Hardware

The LDAD System consists of two LDAD servers (LS2/3), a LAN switch (SMC 8024), a Terminal Server (Cyclades ACS32), Modems (MultiTech MT5600BR), and a DMZ LAN Switch (HP ProCurve 2824). The DMZ consists of two Juniper Netscreen 25 Firewalls, LAN switch (HP ProcCurve 2824), and two Netgear 5 port hubs. The LDAD baseline processes run on the LDAD Cluster (DMZ) and the AWIPS PX Cluster (Internal). Other local applications may run on other internal clusters, such as DX cluster in the case of the LDAD Dissemination Server. Data is transmitted through the DMZ either to the Trusted (internal) AWIPS system or to the Untrusted (External) Users/Systems.

- **LDAD Terminal Server**

The LDAD Terminal Server is a Cyclades Alterpath ACS32, which provides an Ethernet interface for connection to the LDAD LAN Switch and 32 serial ports for connections to communication devices, such as the modems in the Modem Nest, and Console Management ports such as the LS2/3 Servers. Each port can be configured to a maximum speed of 56 K. The terminal server in an average configuration is used to connect 10 dial-in/dial-out modems (including, River Gauge, RRS, and ASOS), four dedicated modems, a fax modem, and various console connections. Port assignments are shown in Table 2.2.1.5-1 as an example.

**NOTE:** The LDAD DL380 server and the LDAD LAN Switch are not included in the table.

**Table L.2-1. Port Assignments**

Port	Function
1	LARC Dial-out
2	HANDAR Dial-out
3	RRS Dial-in
4	RRS Dial-in
5	ASOS Dial-in
6	RRS Dial-in
7	ASOS Dial-in
8	ASOS Dial-in
9	ASOS Dial-in
10	ASOS Dial-in
12	ASOS Dial-in
13	ASOS Dial-in
14	ASOS Dial-in
15	ASOS Dial-in
30	Fax Modem Dial-out

The LDAD terminal server is typically configured with a minimum of 4 IP addresses that is assigned in the address space in which the site LDAD resides. First, a single IP

address is used to address the terminal server as a whole. Next, an individual and unique IP address is used to address Port 1, Port 2 and Port 6.

For Port 1, the IP address is named “7e1out” within the LDAD site and is used to access a dial-out port configured properly for communications with older devices that utilize 7-bit even parity communications configurations. LARC gauge communications is one example of this type of communications.

The IP address assigned to Port 2 within the LDAD site is named “8n1out” and is used in much the same way as the Port 1 address. In this case, the modem connected to Port 2 is configured for 8-bit no parity communications. Current modem communications equipment is usually configured in this manner. One example is Campbell gauge communications.

The IP addresses assigned to Port 3, Port 4 and Port 6 are used by dial-in users who wish to establish direct TCP communications via PPP to the LDAD LAN. Usually, only Port 6 will be configured with an IP address for PPP dial-in connections.

- **LDAD LAN Switch**

The LDAD LAN Switch is an SMC Networks 8024 Ethernet switch with 24 1000BaseT ports. The LAN Switch provides connectivity to external users/systems, the LDAD Terminal Server (Management/Modem RS-232), and the Untrusted side of the LDAD Firewalls (FW1/2). Refer to Appendix L, LDAD Configuration Samples and Firewall Architecture, for more information about the LDAD Firewall.

- **Asynchronous Interface**

The asynchronous interface provides up to 4 asynchronous serial connections between the LDAD Server and external interfaces.

- **Modem Nest**

The LDAD modems are located in the MultiTech chassis. A total of 16 slots are available for MultiTech modem cards (MT5600BR) and two power supplies (PS1600). All sites have at least 10 modems for dial-out, dial-in, and fax capability.

- **Firewall**

Two Juniper SSG320M firewalls are employed to provide network security for the LDAD and AWIPS systems. Each AWIPS site has two firewalls controlled by central configuration manager servers. The central configuration management servers are located at the Network Control Facility (NCF) and the Backup NCF. The Security manager clients are located at the NCF and the Raytheon engineering facility in Silver Spring, MD to support the deployment. As part of the deployment, each regional headquarters will have a Netscreen Security Manager client (NSM) on the PX's. The regional NSM clients will allow the regions to view the configurations of the firewalls at each of their AWIPS sites. Control over the firewall configurations is tiered, with

the central configuration management server having ultimate control; the regional NSM clients can view their sites but they are managed from the central server. Individual AWIPS sites (forecast offices) will not have direct control over their own configurations.

The firewalls are stateful inspection firewalls, and use NAT to prevent AWIPS IP addresses from being advertised outside of the AWIPS network. (Refer to Appendix L for more on Firewall Architecture.)

- **LDAD Server**

The LDAD server cluster is a pair of HP ProLiant DL380 G7 Linux servers that act as a primary and hot spare. The LDAD server machines provide the focal point for all external communications between the AWIPS site and the community, functioning as a pass-through device for all incoming and outgoing data.

Only one of the two machines (ls2 and ls3) is actively working as the LDAD server at any time, and it will be the one that is reachable through the address 192.168.1.10 ("ls1" or "ls") via the LDAD LAN switch. In this document, "the active LS" refers to whichever machine is actively working as the LDAD server.

The LS1 LDAD server (LS2/LS3 listening address) interface is configured on both LDAD servers but it will only be up on the active LS. The active LS is running LDAD ingest processes, listening on the address 192.168.1.10, and reachable through the AWIPS LAN via the hostname "ls1" or "ls."

The ls2/ls3 servers have unique interfaces (ls2-192.168.1.11, ls3-192.168.1.12) that are up at all times. The ls2/3 heartbeat is a private lan pair (ls2-172.16.0.2, ls3-172.16.0.1).

The ls2/ls3 servers share an external IP address for access to the site local LAN and the Internet for data push/pull collection. This external ldad address is assigned by the site and configured by the region in the site's LDAD firewall. Packets are routed by the firewall using Mapped IP (MIP) to the active LS. There is no external network interface connection on the LDAD server.

The VIR switch provides the capability to switch asynchronous serial connections between LS2 and LS3.

#### 2.2.1.5.1 LDAD Server File Systems

- **root (/), /tmp, /usr, /var.** These file systems are maintained as separate logical volumes to reduce the risk of any of these file systems filling up and affecting system operations. All of the remaining file systems are ext3. The **/tmp** file system will be re-created with each boot sequence and performs no journaling.
- **swap space.** The **swap space** is divided into two LVs (Logical Volume) on two separate spindles. The primary swap space on the root drive is also designed as a

dump space in the event of a system panic. This is designated as a swap/dump file system.

- **/opt.** This is used to load COTS applications.
- **/data/logs.** This file system contains the operational logs for software executing on this platform. Subdirectories will further isolate application- or product-specific logs. It also stores all non-system LDAD logs (all FSL- and OST-developed software logs).
- **/ldad.** This file system stores baselined FSL-developed (presently ESRL/GSD) software and any configuration files. It may contain binary applications, scripts, or data as required to support LDAD functions.
- **/data/ldad.** This file system contains scripts and data for LDAD server.
- **/data/Incoming.** This file system is used for temporary storage of raw data acquired from external observation systems (e.g., local automatic remote collector [LARC] gauges, mesonet sensors, and precipitation gauges).
- **/home.** This file system contains all of the user working areas.

An example of mount points on the LDAD servers follows.

```
[root@ls2-bcq ~]# df -H
```

Filesystem	Size	Used	Avail	Use%	Mounted on
/dev/mapper/vg01-lvol01	22G	554M	20G	3%	/
tmpfs	6.3G	0	6.3G	0%	/dev/shm
/dev/mapper/vg01-lvol_awips2	11G	158M	9.9G	2%	/awips2
/dev/sda3	102M	66M	31M	68%	/boot
/dev/mapper/vg01-lvol_Incoming	22G	181M	20G	1%	/data/Incoming
/dev/mapper/vg01-lvol_logs	53G	326M	50G	1%	/data/logs
/dev/mapper/vg01-lvol_home	22G	189M	20G	1%	/home
/dev/mapper/vg01-lvol_ldad	22G	1.1G	19G	6%	/ldad
/dev/mapper/vg01-lvol_opt	22G	338M	20G	2%	/opt
/dev/mapper/vg01-lvol_tmp	5.3G	146M	4.9G	3%	/tmp
/dev/mapper/vg01-lvol_usr	27G	8.5G	17G	34%	/usr
/dev/mapper/vg01-lvol_var	16G	448M	15G	3%	/var
/dev/mapper/vg02-lvol_dataLdad	492G	5.6G	461G	2%	/data/ldad

```
[root@ls1-tbdr ~]# df -H
```

Filesystem	Size	Used	Avail	Use%	Mounted on
/dev/mapper/vg01-lvol01	22G	1.3G	19G	7%	/
tmpfs	6.3G	0	6.3G	0%	/dev/shm
/dev/mapper/vg01-lvol_awips2	11G	24M	9.9G	1%	/awips2
/dev/sda3	98M	66M	27M	72%	/boot
/dev/mapper/vg01-lvol_Incoming	22G	47M	20G	1%	/data/Incoming
/dev/mapper/vg01-lvol_logs	53G	2.5G	48G	5%	/data/logs
/dev/mapper/vg01-lvol_home	22G	852M	20G	5%	/home
/dev/mapper/vg01-lvol_ldad	22G	915M	20G	5%	/ldad
/dev/mapper/vg01-lvol_opt	22G	205M	20G	2%	/opt
/dev/mapper/vg01-lvol_tmp	5.2G	15M	4.9G	1%	/tmp
/dev/mapper/vg01-lvol_usr	27G	7.7G	18G	31%	/usr
/dev/mapper/vg01-lvol_var	16G	369M	15G	3%	/var
/dev/mapper/vg02-lvol_dataLdad	492G	19G	448G	5%	/data/ldad

### 2.2.1.6 Workstations

Workstations (see Exhibit 2.2.1.6-1) provide the primary human/machine interface in AWIPS. They perform a variety of mission-related and system management functions, including the display of alphanumeric, image, and graphic data; animation displays; and toggling, zooming, and panning displays. It has four HWCs: WK1B; WK1C, Color X-Terminal; WK1F, Type IV Workstation (NCF only); and WK1G, Linux Workstation.

AWIPS forecasters use the Linux workstations on mission-critical functions. Upgraded Linux OS X-terminals have replaced the HP Color X-Terminals. New Workstations + X-terminals have three 19-inch LCD monitors and an internal CD-ROM, which support all AWIPS workstations.



**Exhibit 2.2.1.6-1. AWIPS Workstation**

All data are centrally stored and managed at the site. Data in use at the workstation, such as image or graphic products, are retrieved from the Data Server or the Linux Preprocessor and presented at the workstation. The product may be manipulated for display and retained at the workstation for as long as it is being used. Upon completion, it is removed from the local workstation unless the user or the application retains it.

The color X-terminal (WK1C) is a Linux-based workstation platform with one 19-inch monitor. It is connected to the GBLAN and is used primarily for text messaging functions. The Linux workstations (WK1G HWC) support a processing capacity of at least 48 MIPS and include online storage for applications software. They provide high-speed 100 Mbps connectivity to the site LAN and support other interfaces.

The AWIPS Linux workstations are equipped with three 19-inch LCD monitors and support all AWIPS workstation applications.

Workstations are sized to handle the WK HWCI load and are expandable to meet functional and performance requirements as they evolve throughout the AWIPS life cycle. Multiple workstations at each site provide for redundancy. If a workstation fails, a forecaster can move to another workstation and resume work.

The 100 Mbps interface connects to the site LAN (HWCI) via Ethernet for the Linux workstation. The RS-232-C interface connects to the site Monitor and Control Interface HWC.

The file systems on the workstations support the operating system, COTS applications, and developed applications. The workstation configuration has no database requirement; therefore, it does not need to support any raw partitions.

Table 2.2.1.6-1 summarizes the workstation configurations.

**Table 2.2.1.6-1. Workstation Processor Configurations at AWIPS Sites**

Type	Site	Processor	RAM	CACHE	Internal Storage
HP Z600	All WFO/RFCs (LX Replacement)	1 CPU @ 2.26 GHZ	12 GB	8 MB	146 GB
HP Z600	All WFO/RFCs (X-term replacement)	1 CPU @ 2.4 GHZ	6 GB	2 MB L2 Cache	160 GB

### 2.2.1.6.1 *Reserved*

### 2.2.1.6.2 *Linux Workstation File Systems*

- **root (/), /tmp, /usr, and /var.** Linux mandates that these file systems exist.
- **/boot.** This file system stores the Linux kernel and boot-up instructions.
- **swap space.** Swap space is a dedicated partition defined in /etc/fstab and activated at boot time. Swap space is used to store inactive pages of memory when system RAM is full.
- **/local.** This file system contains the output files for the Linux configuration and setup and the Red Hat, GFESuite, and WFOA software installations.
- **/awips/chps\_local.** Reserved for CHPS.
- **/chps.** Reserved for CHPS.
- **/dev/shm.** This file system is the Linux shared memory input queue.
- **/awips/ifps.** This file system is for baselined IFPS software and data.



- **/awips/ldad.** This file system will store baselined FSL-developed WFO-Advanced software and any associated configuration files. It may contain binary applications, scripts, or data as required to support operations.
- **/awips/fxa.** This file system stores baselined FSL-developed (presently ERL/GSD) WFO-Advanced software and any associated logs or configuration files. It may contain binary applications, scripts, logs, or data as required to support operations.
- **/awips/ops.** This file system stores baselined Contractor-developed software and any associated log or configuration files. It may contain binary applications, scripts, logs, or data as required to support operations.
- **/data.** This file system stores data products needed on the workstation.
- **data/dhm.** Data Hydrological Modeling on LX.
- **NFS Mount Points.** The following directory is mounted from the NAS1 in support of AWIPS functions:
  - **/data\_store**
- The following directories are mounted from the NAS in support of AWIPS functions.
  - **/awips/adapt**
  - **/awips/dev**
  - **/data/adapt (WFOs only)**
  - **/data/fxa**
  - **/awips/hydroapps**
  - **/awips/GFESuite**
  - **/data/local**
  - **/data/verify**
  - **/home**
  - **/usr/local/viz/edex/data/hdf5**
  - **/awips/rep (RFCs only for REP)**
  - **/awips/chps\_share (RFCs only)**

The following is an example of WFO Linux workstation mounts.

```
[root@lx1-bcq ~]# df -H
```

**Note:** Workstation running in 64 bit OS.

Filesystem	Size	Used	Avail	Use%	Mounted on
/dev/mapper/vg00-lvol01	969M	587M	332M	64%	/
tmpfs	16G	752K	16G	1%	/dev/shm
/dev/mapper/vg00-lvol_fxa	4.3G	1.9G	2.2G	46%	/awips/fxa
/dev/mapper/vg00-lvol_ifps	1.5G	47M	1.3G	4%	/awips/ifps
/dev/mapper/vg00-lvol_ldad	969M	55M	864M	6%	/awips/ldad
/dev/mapper/vg00-lvol_ops	283M	73M	195M	28%	/awips/ops
/dev/sda1	93M	36M	53M	41%	/boot
/dev/mapper/vg00-lvol_data	3.8G	11M	3.6G	1%	/data
/dev/mapper/vg00-lvol_dhm	969M	1.3M	918M	1%	/data/dhm
/dev/mapper/vg00-lvol_local	4.0G	74M	3.7G	2%	/local

/dev/mapper/vg00-lvol_tmp	477M	14M	438M	4%	/tmp
/dev/mapper/vg00-lvol_usr	15G	11G	2.8G	80%	/usr
/dev/mapper/vg00-lvol_var	2.9G	830M	1.9G	31%	/var
nas1:/awipsADAPT	1.0G	698M	327M	69%	/awips/adapt
nas1:/awipsDEV	4.0G	168K	4.0G	1%	/awips/dev
nas1:/awipsHOME	110G	76G	35G	69%	/home
nas1:/awipsHYDRO	100G	853M	100G	1%	/awips/hydroapps
nas1:/dataADAPT	3.0G	0	3.0G	0%	/data/adapt
nas1:/dataFXA	500G	347G	154G	70%	/data/fxa
nas1:/dataLOCAL	150G	52G	99G	35%	/data/local
nas1:/awipsGFESuit/ws	100G	18G	83G	18%	/awips/GFESuite
nas1:/localapps	50G	149M	50G	1%	/localapps
nas2:/dataSTORE	2.0T	111G	1.9T	6%	/data_store
nas2:/awips2ARCHIVE	3.0T	4.5G	3.0T	1%	/archive
nas1:/dataARCHIVER	1.0T	8.3G	1016G	1%	/data/archiver
nas1:/awips2REPO	40G	21G	20G	53%	
/data/fxa/INSTALL/awips2					
nas1:/aiidata/share	500G	61G	440G	13%	
/awips2/edex/data/share					
nas1:/aiidata/fxa/trigger	500G	61G	440G	13%	
/awips2/edex/data/fxa/trigger					
nas1:/verify	2.0T	6.5G	2.0T	1%	/data/verify

### 2.2.1.7 Linux Preprocessor

Two PX preprocessors (PX1 and PX2) are at every AWIPS site to run applications. The PX architecture is shown in Exhibit 2.2.1.7-1.

The PXs at the site are each sized to handle the full system load in the event one of them fails. Each contains 2X 146 GB of internal storage. Refer to Exhibit 2.2.1.7-2, Linux Preprocessor (PX) Hardware.

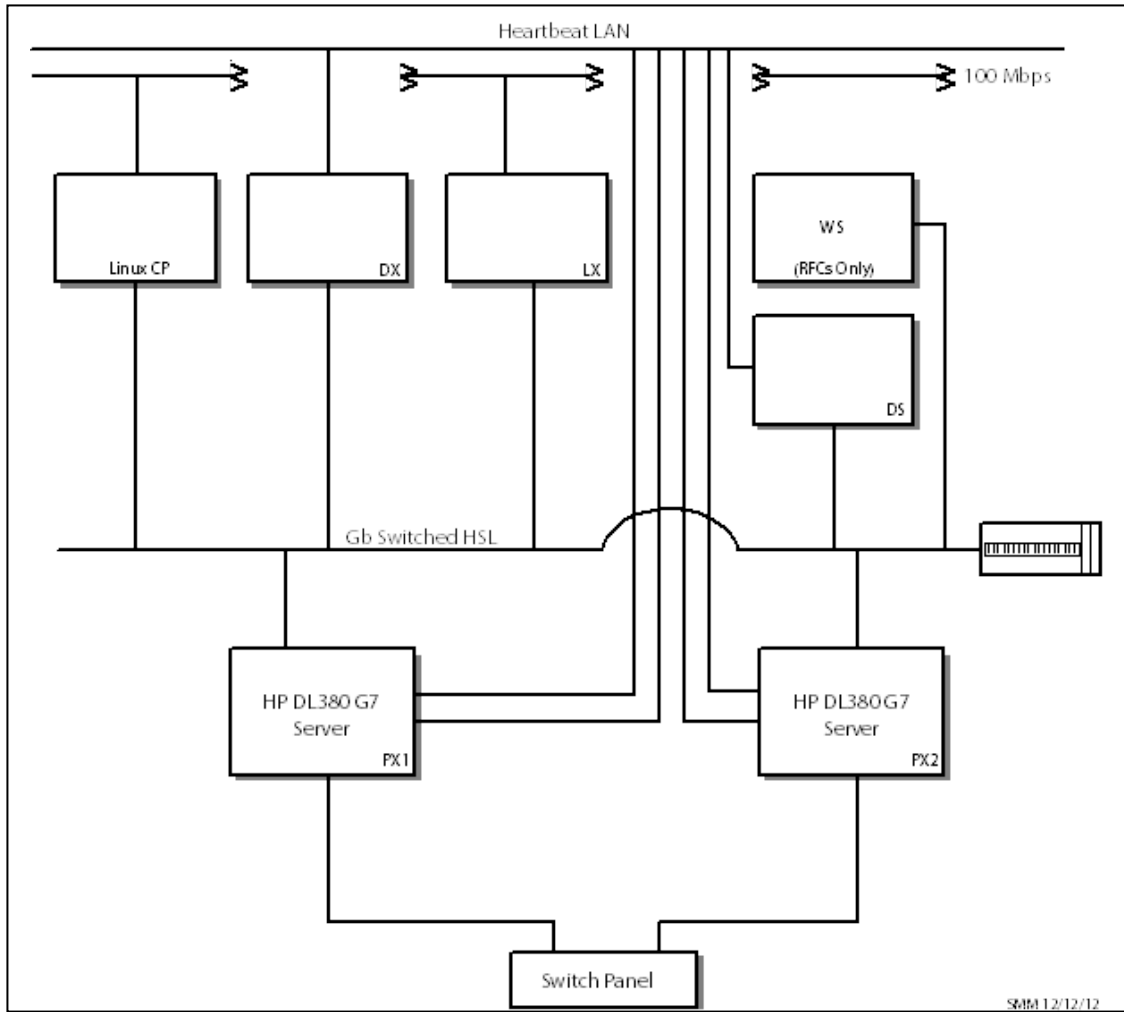

**Exhibit 2.2.1.7-1. Linux Preprocessors (PX) Architecture**

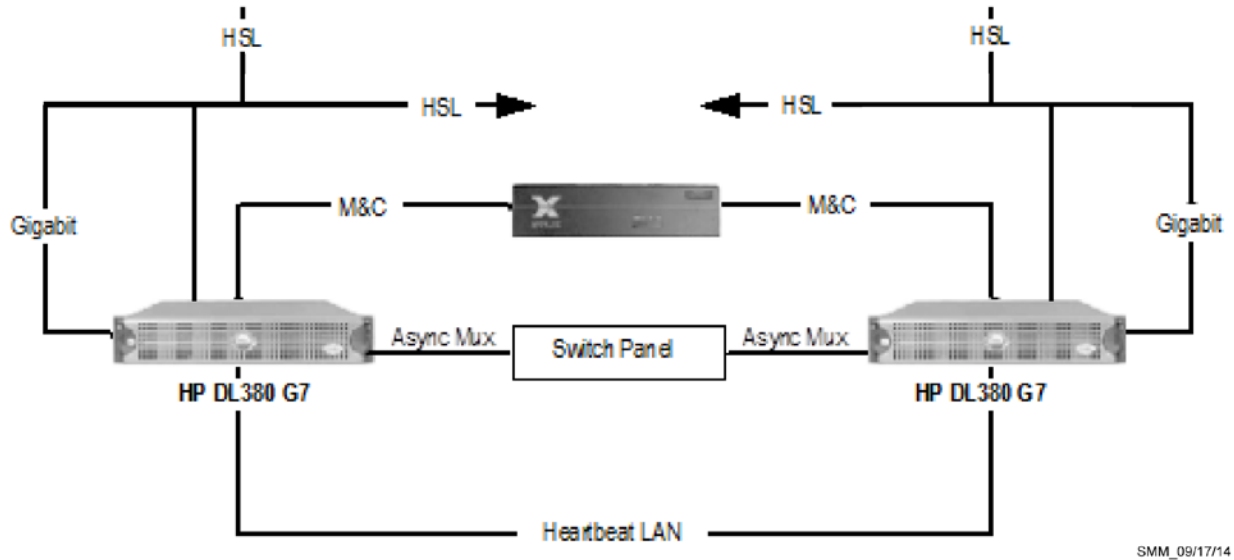

**Exhibit 2.2.1.7-2. Linux Preprocessor (PX) Hardware**

PX configuration is summarized in Table 2.2.1.7-1.

**Table 2.2.1.7-1. Linux Preprocessor Configurations at AWIPS Sites**

Type	Site	Processor	RAM	CACHE	Internal Storage
HP DL380 G7	All AWIPS Sites	2x2 4 GHZ Quad Core	12 GB SDRAM	12 MB	2X 146 GB

The PX preprocessors maintain a continuous heartbeat between the two processors and accomplish an automatic processing switch to the other processor should a processor fail. Each PX executes a predefined software package, and each PX can take over the responsibility for all PX functions on the failure of one of the PXs.

The PX has LAN and asynchronous serial interfaces. The serial interface is Electronics Industry Association (EIA) RS-232 and is used to provide a system console connection.

Exhibit 2.2.1.7-3 shows the PX processor interfaces. The RS-232-C interfaces represent the site monitor and control interface, which provides console port interfaces to the CP, workstation, SBN, LAN, and WAN. The 1 Gbps interface connects to the site LAN.

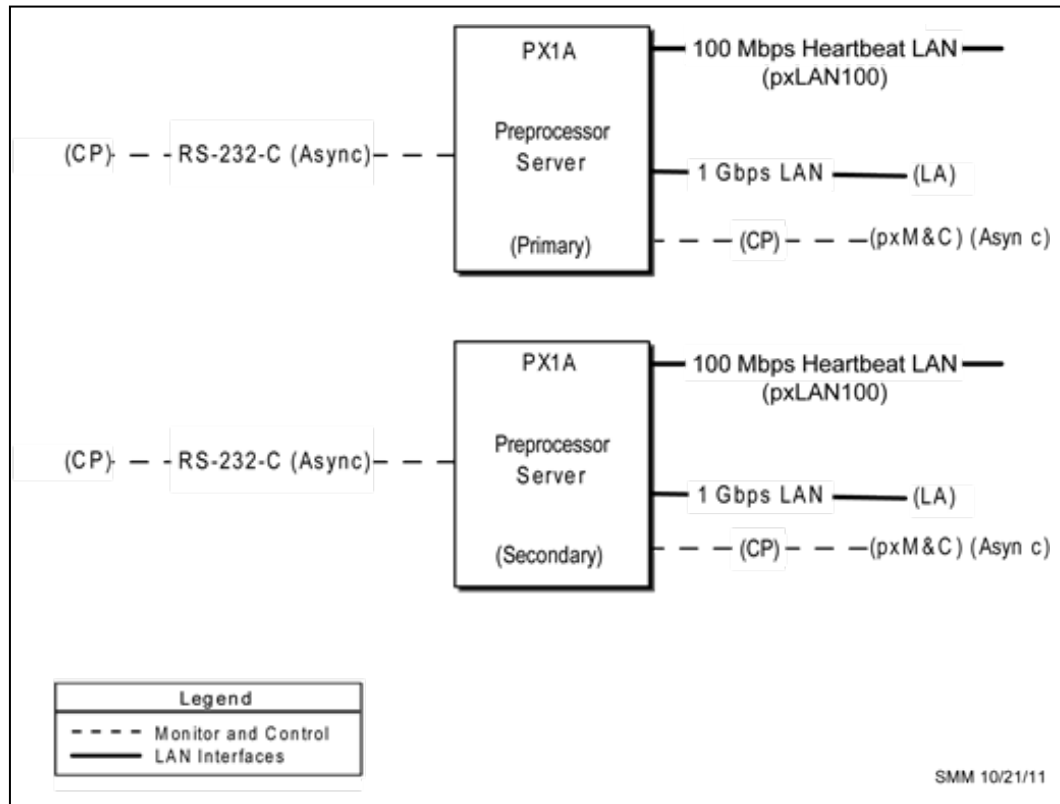

**Exhibit 2.2.1.7-3. Linux Preprocessor (FX) Interfaces**

- **Linux Preprocessor Processors (PX1A)**

Two PX preprocessors (PX1A), a primary and a secondary server, are deployed to every AWIPS site. The PX preprocessors are HP DL380 G7 servers.

### 2.2.1.7.1 Preprocessor Server File Systems

The PX file systems support the following:

- Operating system
- COTS applications
- Developed applications.

The file systems on the PX are:

- **root (/)**. This file system is superuser's (**root**) home directory.
- **/boot**. This file system contains boot-related files (kernel).
- **/tmp**. This file system is used to store temporary files that users and system programs create.

- **/usr.** This file system holds most user-related documents, command-related files, and installation files.
- **/var.** This file system contains system log files for most applications (mail, print spoolers, and system information).

#### 2.2.1.7.2 Preprocessor Server File Systems

The PX file systems support the following:

- Operating system
- COTS applications
- Developed applications.

The file systems on the PX are:

- **root (/).** This file system is superuser's (**root**) home directory.
- **/boot.** This file system contains boot-related files (kernel).
- **/tmp.** This file system is used to store temporary files that users and system programs create.
- **/usr.** This file system holds most user-related documents, command-related files, and installation files.
- **/var.** This file system contains system log files for most applications (mail, print spoolers, and system information).
- **swap space.** The swap space is divided into one logical volume on the root disk. The primary swap space on the root drive is also designed as a dump space in the event of a system panic. This is designated as a swap/dump file system.
- **/awips/ops.** This file system is used to store baselined contractor-developed software and any associated log or configuration files. It contains binary applications, scripts, logs, or data as required to support operations.
- **/awips/fxa.** This file system stores baselined WFO-Advanced software developed by the FSL (presently ESRL/GSD) and any associated configuration files. It may contain binary applications, scripts, or data as required to support operations.
- **/awips/ifps.** This file system is for baselined IFPS software and data.
- **/awips/laps.** This file system will store baselined FSL-developed Local Analysis and Prediction System (LAPS) software and any associated configuration files. It may contain binary applications, scripts, or data as required to support operations.
- **/awips/ldad.** This file system will store baselined FSL-developed WFO-Advanced software and any associated configuration files. It may contain binary applications, scripts, or data as required to support operations.

- **/data/logs.** This file system contains the operational logs for software executing on the platform. Subdirectories will further isolate application- or product-specific logs.
- **/dev/shm.** This file system contains the shared memory.
- **NFS Mount Points.** The following directories are mounted from the NAS:
  - **/home**
  - **/data/GFE**
  - **/data/fxa**
  - **/awips/adapt**
  - **/awips/GFESuite**
  - **/awips/hydroapps**
  - **/data/adapt**
  - **/data/local**
  - **/awips/dev**

The following is an example of the PX mount points at the WFOs.

```
[root@px1-tbw3 ~]# df -H
```

Filesystem	Size	Used	Avail	Use%	Mounted on
/dev/mapper/vg01-lvol01	1.1G	765M	199M	80%	/
tmpfs	6.3G	0	6.3G	0%	/dev/shm
/dev/mapper/vg01-lvol_fxa	5.1G	2.2G	2.7G	45%	/awips/fxa
/dev/mapper/vg01-lvol_ifps	1.6G	2.4M	1.5G	1%	/awips/ifps
/dev/mapper/vg01-lvol_laps	1.1G	145M	819M	16%	/awips/laps
/dev/mapper/vg01-lvol_ldad	1.1G	164M	800M	18%	/awips/ldad
/dev/mapper/vg01-lvol_ops	297M	74M	208M	27%	/awips/ops
/dev/mapper/vg01-lvol_awips2	11G	3.9G	6.1G	39%	/awips2
/dev/sda3	98M	78M	15M	85%	/boot
/dev/mapper/vg01-lvol_logs	2.1G	838M	1.1G	44%	/data/logs
/dev/mapper/vg01-lvol_tmp	500M	29M	446M	6%	/tmp
/dev/mapper/vg01-lvol_usr	27G	13G	13G	50%	/usr
/dev/mapper/vg01-lvol_var	3.1G	1.8G	1.2G	60%	/var
/dev/mapper/vg01-lvol_local	4.1G	21M	3.9G	1%	/local
nas1:/awipsADAPT	1.1G	733M	342M	69%	/awips/adapt
nas1:/awipsDEV	4.3G	173k	4.3G	1%	/awips/dev
nas1:/awipsGFESuit/ws	108G	19G	89G	18%	/awips/GFESuite
nas1:/awipsHOME	119G	88G	32G	74%	/home
nas1:/awipsHYDRO	108G	902M	107G	1%	/awips/hydroapps
nas1:/dataADAPT	3.3G	0	3.3G	0%	/data/adapt
nas1:/dataFXA	537G	462G	76G	86%	/data/fxa
nas1:/dataGFE	21M	0	21M	0%	/data/GFE
nas1:/dataLOCAL	162G	56G	106G	35%	/data/local
nas1:/verify	2.2T	48G	2.2T	3%	/data/verify
nas1:/aiidata	537G	67G	471G	13%	/awips2/edex/data
nas1:/localapps	54G	426M	54G	1%	/localapps
nas1:/GFESuite2	11G	3.6G	7.2G	34%	/awips2/GFESuite
nas2:/dataSTORE	2.2T	188G	2.1T	9%	/data_store
nas1:/awips2REPO	43G	35G	8.9G	80%	
/data/fxa/INSTALL/awips2					
nas1:/bmhDATA	43G	11M	43G	1%	/awips2/bmh/data
nas1:/bmhCONF	22G	66k	22G	1%	/awips2/bmh/conf
nas1:/bmhRESULTS	22G	7.7M	22G	1%	
/awips2/bmh/neospeech/result					
nas2:/awips2ARCHIVE	3.3T	18G	3.3T	1%	/archive

```
nas1:/dataARCHIVER          1.1T  8.9G  1.1T  1% /data/archiver
```

### 2.3 *NCF Time Source*

The NCF time source is located at the ANCF and the BNCF. It receives, decodes, and provides AWIPS with time from the NIST WWV external time source. After the ANCF/BNCF Comm Server is synchronized with the NIST WWV, it synchronizes all other LAN clocks at the site. All AWIPS system clocks are synchronized to within 1 second of the NIST WWV time using the network time protocol over the WAN. NRSs are synchronized over the SBN.

### 2.4 *Printers*

All AWIPS sites have two color graphics printers.

Both color graphics printers are Dell 5130cdn. The color graphics printers generate publication-quality color output for use in publications and journals and print high-quality black and white products. The color graphics printers can generate laser-quality output of 300 dpi on paper up to 8.5 inches by 14 inches (legal size). Each color graphics printer has its own IP address and is connected to the GB LAN (Ethernet).

### 2.5 *AWIPS Software*

AWIPS software is divided into three general classes:

1. AWIPS contractor-developed software
2. Government-developed software
3. COTS software and Freeware.

#### 2.5.1 *AWIPS Contractor-Developed Software*

The AWIPS contractor-developed software categories are:

- **Communications Software.** Receives and processes the satellite signal. This software processes the signal from the demodulators and stores the decoded products in the AWIPS database.
- **Monitor and Control (M&C) Software.** Tracks functioning of the AWIPS system at the site and transmits the collected information to the NCF. This software allows the NCF to control site hardware and software, if needed.
- **EDEX System Deployment.** A fully functional AWIPS II EDEX installation requires deployment and operation of several pieces of software. These include a PostgreSQL database, a Unidata Local Data Manager (LDM) as a data source, an AWIPS II Radar Server (RCM), an Apache Qpid messaging service, and the EDEX software itself.



## 2.5.2 Government-Developed Software

The Government has developed most of the AWIPS weather applications.

- NOAA’s Earth System Research Laboratory/Global Systems Division (GSD, formerly FSL) developed the AWIPS D2D user interface, IFPS (jointly, with MDL), LAPS, and LDAD applications.
- The NWS Meteorological Development Laboratory (MDL) developed the background hydrometeorological applications, including Climate, AvnFPS, SCAN, FFMP, IFPS (jointly, with FSL), HWR, LAMP, Pre-LAMP, Guardian, FSI, SNOW, GFE, and ADAPPT Foundation.
- Other Government-developed software appear as stand-alone applications, for example, the Office of Hydrologic Development (OHD) and the WFO Hydrologic Forecast System (HFS) applications (HydroView, RiverPro, and HydroBase). These applications are documented in their own manuals.

**NOTE:** Most of the Government-developed software has been transitioned to Raytheon Software Maintenance and Support for maintenance.

## 2.5.3 Commercial Off-the-Shelf (COTS) Software and Freeware

### 2.5.3.1 AWIPS II: COTS Software and Freeware

AWIPS relies on COTS software when possible. Often the COTS software is invisible to users. For example, all of the individual hardware items that compose the AWIPS system are commercially available, and all of them use the software that their manufacturers provide. COTS software is documented via the commercial documentation provided with the COTS software package.

Table 2.5.3.1-1 lists the COTS software and freeware used in AWIPS II.

Note: In addition, the following have been updated in Release 16.2.2

org.apache.commons.pool to 1.6, org.apache.commons.lang to 2.6 and org.apache.commons.compress to 1.10

**Table 2.5.3.1-1. COTS Software and Freeware Used in AWIPS II**

Component	Version	Description
ActiveMQ	5.12.0	JMS (still used by AlertViz and internally in parts of Camel)
Apache Commons Configuration	1.10	The Commons Configuration software library provides a generic configuration interface which enables a Java application to read configuration data from a variety of sources.
Apache Batik	1.8	A Java-based toolkit for applications or applets that want to use images in the Scalable Vector Graphics (SVG) format for various purposes, such as display, generation or manipulation

Component	Version	Description
Apache Camel	2.13.2	Apache Camel is a rule-based routing and mediation engine that provides a Java object-based implementation of the Enterprise Integration Patterns using an API (or declarative Java Domain Specific Language) to configure routing and mediation rules.
Apache CXF	2.7.14 or better	
Apache Derby	10.12.1.1	Apache Derby, an Apache DB subproject, is an open source relational database implemented entirely in Java
Apache HttpClient	4.3.5	The Hyper-Text Transfer Protocol (HTTP) is a significant protocol used on the Internet today. Web services, network-enabled appliances and the growth of network computing continue to expand the role of the HTTP protocol beyond user-driven web browsers, while increasing the number of applications that require HTTP support.
Apache Httpd	2.2.15-47	
Apache MINA	1.1.7	Network application framework
Apache WSS4J	1.6.5	Web Services Security
Apache XML Beans	2.6.0	XMLBeans is a technology for accessing XML by binding it to Java types.
Apache JSON	1.9.x	
Ant	1.9.6	Java Build Tool
Ant-Contrib	1.0b3	Additional useful tasks and types for Ant
Antlr	2.7.6	Parser generator
Atomikos TransactionEssentials	3.6.2	Transaction management system
Basemap	1.0.7	
Bitstream Vera Fonts	1.10	Font library from Gnome
bzip2	None	Stream compression algorithm
C3p0	0.9.1	An easy-to-use library for making traditional JDBC drivers “enterprise-ready” by augmenting them with functionality defined by the jdbc3 spec and the optional extensions to jdbc2
Camel	2.16.0	Enterprise Service Bus
Cglib (Byte Code Generation Library)	2.2	A high-level API; used to generate and transform JAVA byte code
CherryPy	3.1.2	Object-oriented HTTP framework
commons-beanutils	1.8.3	Apache Common Libraries
commons-codec	1.4.1	Apache Common Libraries
commons-collection	3.2	Apache Common Libraries
commons-configuration	1.6	Apache Common Libraries
Commons-cli	1.2	Apache Common Libraries
commons-digester	1.8.1	Apache Common Libraries
commons-cxf	2.5	Apache Common Libraries
commons-httpclient	3.1	Apache Common Libraries
commons-lang	2.3	Apache Common Libraries
commons-logging	1.1.1	Apache Common Libraries
commons-management	1.0	Apache Common Libraries
commons-pool	1.3	Apache Common Libraries
commons-validator	1.2	Apache Common Libraries

Component	Version	Description
CXF (Apache)	2.7.10	Apache CXF is an open source services framework. CXF helps to build and develop services using frontend programming APIs, like JAX-WS and JAX-RS. This is a FOSS upgrade specifically needed for Data Delivery security. The new version will strengthen DD security and provide enhanced security capabilities that are not in the current version.
datautil	2.4.2+	
dom4j	1.6.1	An open source library for working with XML, XPath, and XSLT on the Java platform using the Java Collections Framework
dods	1.1.7	Java Library
dwr (direct web remoting) Getahead	1.1.3	Java open source library
Eclipse	3.8.2	Java IDE
Eclipse CDT	5.0.2	C/C++ IDE for Eclipse
ehcache	1.3.0	Caching Support
GEOS	3.0.2	Geometry Engine, Required for PostGIS
Geo Tools	10.5	GeoTools is a free software (LGPL) GIS toolkit for developing standards compliant solutions. It provides an implementation of Open Geospatial Consortium (OGC) specifications as they are developed.
Geo Tools Gdal	1.9.2-4	Geo Tools Plug-in
Geo Tools Imageion	1.1.8	Geo Tools Plug-in
GeoTools Java API	2.6.4	Java API for Manipulation of Geospatial Data
Geronimo-jms	1.1 spec 1.1.1	Server runtime framework
GRIBJava	8.0	Grib Java Decoder
h5py	1.3.0-3	HDF5 for Python
hdf5	1.8.4-patch1	Core HDF5 APIs
hdf5	2.5	Core HDF5 APIs
Hibernate	4.2.15	Data Access Layer
IzPack	4.2.0	Installer creator for EDEX
JAI	1.1.3	Java API for Image Manipulation
JAI – Image I/O	1.1	Plug-ins for JAI
Jasper	1.900.1 (Security Patch)	JPEG-2000 codec
Java	7u80 and 7u76	Kit for both 32-bit and 64-bit
javax.mail	1.4.3	mail modeling classes
javax.measure	1.0-beta-2	Strong types for measurements
javax.persistence	1.0.0	persistence classes and interfaces
javax.vecmath	1.3.1	Coordinates and vectors
Jep	3.4	Java Python interface
Jetty	8.1.15	Jetty provides an HTTP server, HTTP client, and javax.servlet container
JFreeChart	1.0.19	
jGraphT	0.6.0	A free Java graph library that provides mathematical graph-theory objects and algorithms
JMock	2.0.0	Java Mock Object Framework

Component	Version	Description
jna (java native access)	3.09	Provides Java programs easy access to native shared libraries (DLLs on Windows) without writing anything but Java code—no JNI or native code is required. This functionality is comparable to Windows' Platform/Invoke and Python's ctypes. Access is dynamic at runtime without code generation.
Jogl	1.1.1-rc8	Provides hardware-supported 3D graphics
Jscience	4.3.1	Library for Scientific Calculations and Visualizations
JTS Topology Suite	1.10	Java API for 2D spatial data
JUnit	4.10	Java Unit Test Framework
lapack	3.0.0	Linear Algebra Package for python
Ldm	6.12.6	Local Data Manager
Logback	1.1.2	It brings improvements including faster logging and allowing users to change the log configuration without restarting the Java processes
libgfortran	4.1.2	Fortran Library
matplotlib	1.4.3+	Python 2D Plotting Library
Mozilla Rhino	1.6R7	Implementation of JavaScript embedded in Java
NCEP Grib2 Libraries		Libraries for decoding & encoding data in GRIB2 format
cnvgrib	1.1.8 and 11.9	Fortran GRIB1 <--> GRIB2 conversion utility
g2clib	1.1.8	"C" grib2 encoder/decoder
g2lib	1.1.8 and 1.1.9	Fortran grib2 encoder/decoder and search/indexing routines
w3lib	1.6 and 1.7.1	Fortran grib1 encoder/decoder and utilities
nose	0.11.1-3	Python unit test extension
Nvidia Graphics	340.76	Graphics Card
NumPy	1.9.2	Numerical Python Scientific package for Python
objectweb asm	2.1	An all-purpose Java bytecode manipulation and analysis framework. It can be used to modify existing classes or dynamically generate classes, directly in binary form
Opendap2	1.0.0	Open-source Project for a Network Data Access Protocol. The OPeNDAP Data Access Protocol (DAP) is a protocol for requesting and transporting data across the web. DAP 2.0 uses HTTP to frame the requests and responses.
Openfire	3.7.1	Collaboration Server – Not used but eventually will replace Wildfire. Only 3.7 approved
OpenSAML	2.6.5	OpenSAML-Java is a low-level library written in Java that provides support for producing and consuming SAML messages, creating and evaluating digitally signed and encrypted content, and working with SAML bindings.
perl	2.19.3-1	Perl DBD
Pil	1.1.6-3	Python Imaging Library
Pgadmin	1.18	A database design and management application designed for use with PostgreSQL. It is written in C++ using the wxWidgets ( <a href="http://www.wxwidgets.org">http://www.wxwidgets.org</a> ) cross-platform framework to allow it to run on multiple platforms.
pmw	1.3.2-3	A toolkit for building high-level compound widgets in Python using the Tkinter module
PostGIS	2.0.6	Geographic Object Support for PostgreSQL
PostgreSQL	9.3.10	Database
Proj	4.6.1	Cartographic Projections library
pupynere	1.0.13-3	Python module for reading and writing NetCDF files

Component	Version	Description
pycairo	1.2.2-3	A 2D graphics library with support for multiple output devices.
Pydev	3.4.1	Python Development Environment
pygtk	2.8.6-3	Used to easily create programs with a graphical user interface using the Python programming language
PyTables	2.1.2	Python package for managing hierarchical datasets
Python	2.7.10	Dynamic programming language
Python megawidgets	1.3.2	Toolkit for building high-level compound widgets in Python using the Tkinter module.
pytz	2015.4+	
Qpid	0.32	Open Source AMQP (Advanced Message Queuing Protocol) Messaging
SciPy	0.15.1	Python Library of Scientific Tools.
ScientificPython	2.8-3	Python library for common tasks in scientific computing
shapely	1.2.16-1	A BSD-licensed Python package for manipulation and analysis of planar geometric objects
slf4j (Simple Logging Facade)	1.6.1	For Java; serves as a simple facade or abstraction for various logging frameworks
smack	2.2.1	An Open Source XMPP (Jabber) client library for instant messaging and presence
stomp.py	revision 18	Python client library for accessing messaging servers
Spring Framework	4.1.6	Layered Java/J2EE application platform
Subclipse	1.4.8	Eclipse plugin for Subversion support
SWT Add-ons	0.1.1	Add-ons for Eclipse SWT widgets
Symphony OGNL	2.7.3	Object-Graph Navigation Language; an expression language for getting/setting properties of Java objects
Thrift	0.9.0	Binary Serialization Framework
Tomcat Native	1.1.17	Library for native memory control
TPG	3.1.2-3	Parser generator for Python
utilconcurrent	1.3.2	Utility classes
Velocity	1.5.0	Templating Engine
Wss4j	1.6.19	
werkzeug	3.1.2-3	Python WSGI utility library
Wildfire	3.1.1	Collaboration Server
Xalan Java	2.7.2	Xalan-Java is an XSLT processor for transforming XML documents into HTML, text, or other XML document types. It implements XSL Transformations (XSLT) Version 1.0 and XML Path Language (XPath) Version 1.0 and can be used from the command line, in an applet or a servlet, or as a module in other program.
xmltask	1.15.1	Facility for automatically editing XML files as part of an Ant build
YAJSW	11.11	YAJSW is a java centric implementation of the java service wrapper (JSW).

### 2.5.3.2 Mobile Code Technologies

NIST SP 800-53, Information Security, Appendix B, provides the following definitions regarding mobile code:

- *Mobile Code Software*: Programs or parts of programs obtained from remote information systems, transmitted across a network, and executed on a local information system without explicit installation or execution by the recipient.
- *Mobile Code Technologies Software*: Technologies that provide the mechanisms for the production and use of mobile code (e.g., Java, JavaScript, ActiveX, VBScript).
- AWIPS II mobile code consists of micro engine scripts that are written in Python. These micro engine scripts execute only within EDEX.

## 2.6 AWIPS I and AWIPS II

### 2.6.1 What's Changed in AWIPS

AWIPS II aims to be a blackbox rewrite of AWIPS I. It is written mostly in java, but python is also extensively used, especially in GFE. AWIPS II is built upon the following Open Source projects:

- eclipse: <http://www.eclipse.org>
- camel: <http://camel.apache.org/>
- spring: <http://www.springsource.org/>
- hibernate: <http://www.hibernate.org/>
- qpid: <http://qpid.apache.org>
- Others (postgres, HDF5, logback, thrift).

**CAVE, the “Common AWIPS Visualization Environment”** for AWIPS II, runs on the workstations, like D2D, GFE, and HYDRO. CAVE is an RCP application (“RCP” stands for Eclipse’s “Rich Client Platform”). The RCP is a framework of a core set of approximately 30 plug-ins, although plug-ins are the smallest unit of RCP functionality. With plug-ins, code can be loosely coupled; the code is also maintainable and extensible. The core plug-ins provide extension points, which applications can use to extend the functionality of the framework. One such extension point is `org.eclipse.ui.perspectives`. In AWIPS II, D2D, GFE, and HYDRO are CAVE perspectives.

CAVE variations include the following:

- Map pans and zooms.
- Localization perspective. A localization perspective exists. It is from the localization perspective that smartTools and Utilities are edited; they are not edited by right-clicking in the EA window as it is done in AWIPS I.
- GFE perspective. There is no GM realignment button in AWIPS II. You can realign the GM by dragging.

The **AWIPS II server is EDEX** (Environmental Data Exchange). EDEX consists of:

- An Enterprise Service Bus (ESB)
  - JVMs (Java Virtual Machines). There are currently four JVMs per server, clustered across two servers. Spring and Camel form the backbone of the ESB. It is in this environment that AWIPS II server code runs.
    - Spring manages software objects. It creates them (initiates them), and injects them with initial values using directives retrieved from xml. This makes for a loosely coupled, flexible system. The runtime behavior of the system can be changed by modifying the xml, not the java source code. See <http://static.springsource.org/spring/docs/2.5.x/reference/beans.html>
    - Camel routes messages using the Enterprise Integration Patterns described at <http://www.enterpriseintegrationpatterns.com/eaipatterns.html>
  - A JMS broker – messaging middleware.
    - AWIPS II’s JMS broker is QPID.
    - QPID is an important part of data ingest. The SBN LDM client, radar, and LDAD ingest processes all send messages to a broker queue, which is read by the ESB. Also, MHS (just like LDAD and LDM) writes a message to /data\_store and posts a message to qpid. That is how MHS products get into AWIPS II.
    - Once the message is read, the ESB looks in /awips2/edex/data/utility/edex\_static/base/distribution to determine which data plug-in to use to ingest and decode the raw product (yes, EDEX has plug-ins too, although they are not RCP plug-ins). Each data type has a plug-in (there are about 50), and each plug-in has a Data Access Object (DAO) or a set of DAOs that is used to store and retrieve data from the database. The DAOs interact with postgres’ metadata db and the hdf5 filesystem.
 

The postgres - metadata database is used in conjunction with the hdf5 filesystem to form the AWIPS II database, with HYDRO being the notable exception. HYDRO databases will be left as they are in AWIPS I.

Data is stored in the HDF5 filesystem. It is not meant to be accessed directly. See <http://www.hdfgroup.org/HDF5/> .

AWIPS II has a development environment. Called the **“AWIPS Development Environment,”** or **“the ADE,”** it consists of Eclipse’s IDE (also an RCP app) and the software for the entire system, minus the legacy rehosted code. Clients like CAVE can be run from the ADE, so it is possible to make changes to CAVE code. You can make changes to EDEX, then compile and deploy with the ADE and run your modified EDEX.

AWIPS II continues to use heartbeat software to manage application packages on the PX1/2 and DX1/2 clusters. Although heartbeat is no longer used on the DX3/4 server pair, it has been added to the CPSBN1/2 server pair. AWIPS II clustering strategy and heartbeat packages are discussed in section 2.8, “AWIPS II Server Clustering.” Because

AWIPS II does not use the heartbeat cluster on DX3/4, any locally defined crons formerly managed by the dx3apps and dx4apps packages have been moved to another server.

The **Direct Attached Storage** (DAS). File system mounts are covered in section 2.11, “Basic AWIPS II Data Storage Architecture.”

**AWIPS II software performs its own logging.** Log locations vary with the different AWIPS II software components. AWIPS II logging is covered in section 2.10, “Basic AWIPS II Logging Architecture.”

### 2.6.2 *What’s Not Changed in AWIPS*

AWIPS II reuses a number of the existing AWIPS I applications. These include:

- MHS (Message Handling System)
- Climate software
- HWR
- NWRWAVES/NWREditor/CRS
- FSI (server path has changed; the GUI has been wrapped)
- LDAD (Local Data Acquisition and Dissemination)
- NWWS (NOAA Weather Wire Service)
- ASYNC Scheduler
- LSR (Local Storm Report)
- FloodEvent Archiver
- HydroGen
- RiverPro
- WFO/RFC Archiver (Weather Forecast Office/River Forecast Center Archiver)
- LAPS/MSAS (Local Analysis and Prediction System/MAPS Surface Assimilation System)
- Chatserver
- LegalArchiver
- Certain Command Line Interfaces (textdb, fxaAnnounce, sendMsgToGuardian).

For the retained AWIPS I software, basic management techniques are unchanged; high-availability packages and server cron configuration files are still used (the package filenames start with *a2*, for example, *a2px2apps*). Log names and locations are unchanged.

## 2.7 *Basic AWIPS II Software Deployment*

AWIPS II replaces a large portion of the existing AWIPS data ingest, processing, and storage capabilities, and it consolidates many forecaster applications into a single



visualization tool. The primary AWIPS II application for data ingest, processing, and storage is the Environmental Data EXchange (EDEX); the primary AWIPS II application for forecaster visualization/data manipulation is the Common AWIPS Visualization Environment (CAVE).

AWIPS II takes a unified approach to data ingest. Most data types follow a standard path through the system. Variations on this basic data flow include local radar (Open Radar Product Generator (ORPG) / Supplemental Product Generator (SPG)) products, and Local Data Acquisition and Dissemination (LDAD) delivered products. AWIPS II provides interfaces for communicating with the ORPG/SPG and LDAD servers.

At a high level, data flow describes the path a piece of data follows through the system. The path starts with the data source and includes storing the raw data, decoding the data, and storing the decoded data in a form that makes it available for display and/or manipulation by the forecaster. For more on this process, see Chapters 4 – 7.

AWIPS II supports automated processing using a cron-like capability built into the EDEX process. EDEX also provides database and Processed Data Storage management; Raw data storage is managed by the Local Data Manager (LDM) process. Script running in response to data arrival is also supported within EDEX. These topics are covered in Chapters 11 and 12 of this manual.

In addition to programs developed specifically for AWIPS, AWIPS II uses several commercial off-the-shelf (COTS) and Free or Open Source software (FOSS) products to assist in its operation. These applications include the Unidata LDM, the Apache web server, the Queue Processor Interface Daemon (QPID) Apache AMQP Message Broker, and the Java and Python runtime systems.

At a high level, data flow describes the path taken by a piece of data from its source to its display by a client system. This basic data flow concept is shown in Exhibit 2.7-1. The overall AWIPS II Server Processes and AWIPS II Servers Overview are shown in Exhibits 2.7-2 and 2.7-3 respectively.

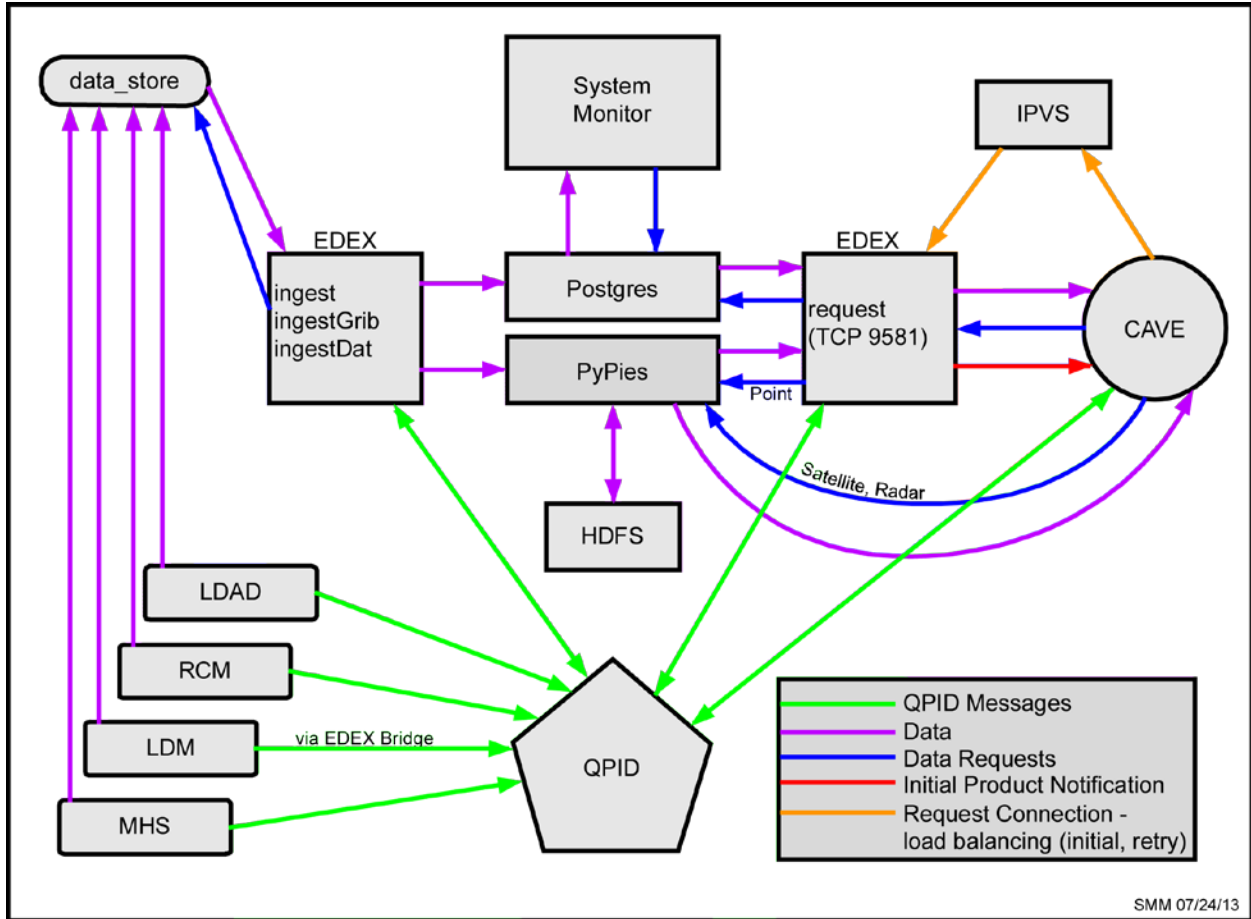

Exhibit 2.7-1. Overall AWIPS II Data Flow

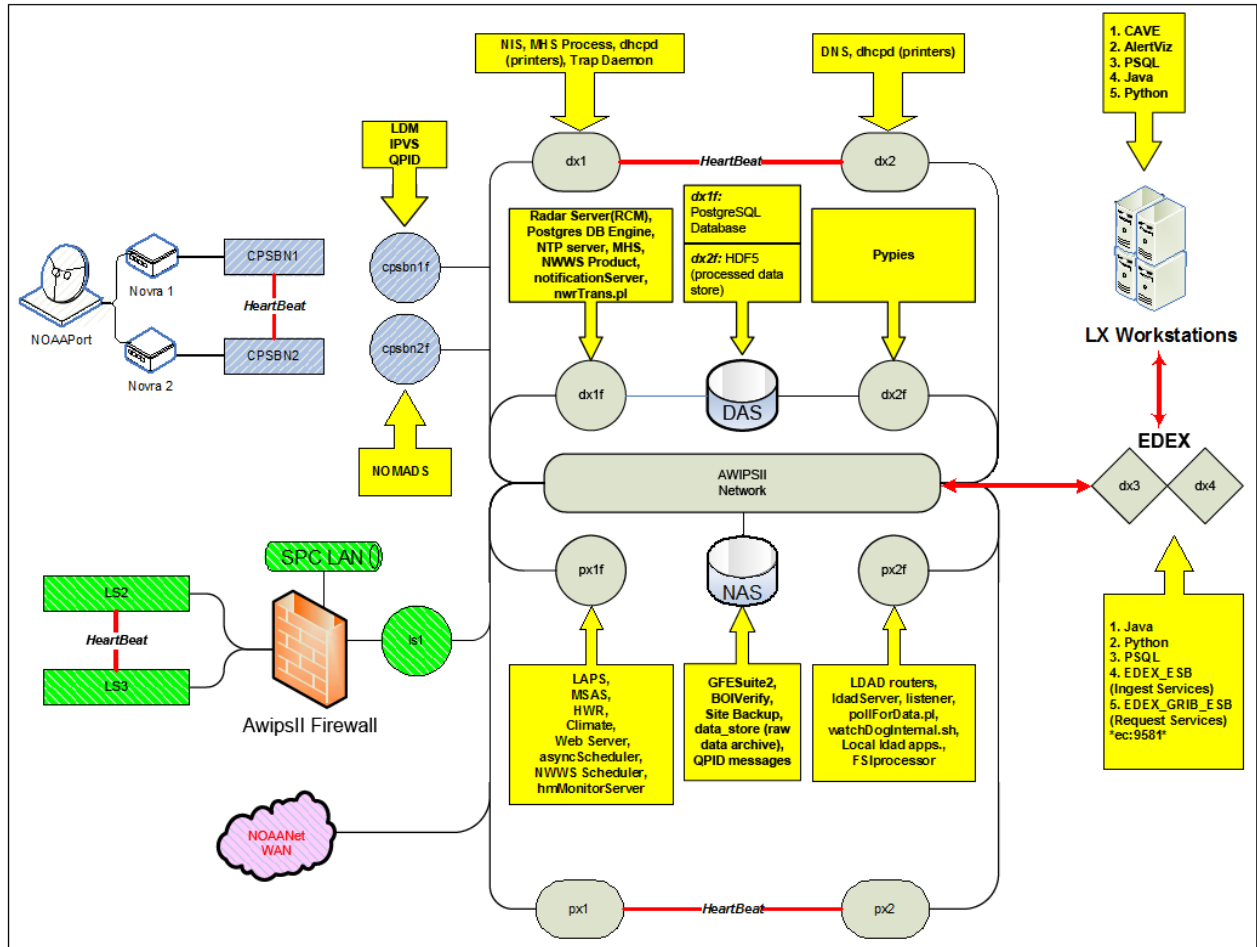

Exhibit 2.7-2. Overall AWIPS II Servers Processes

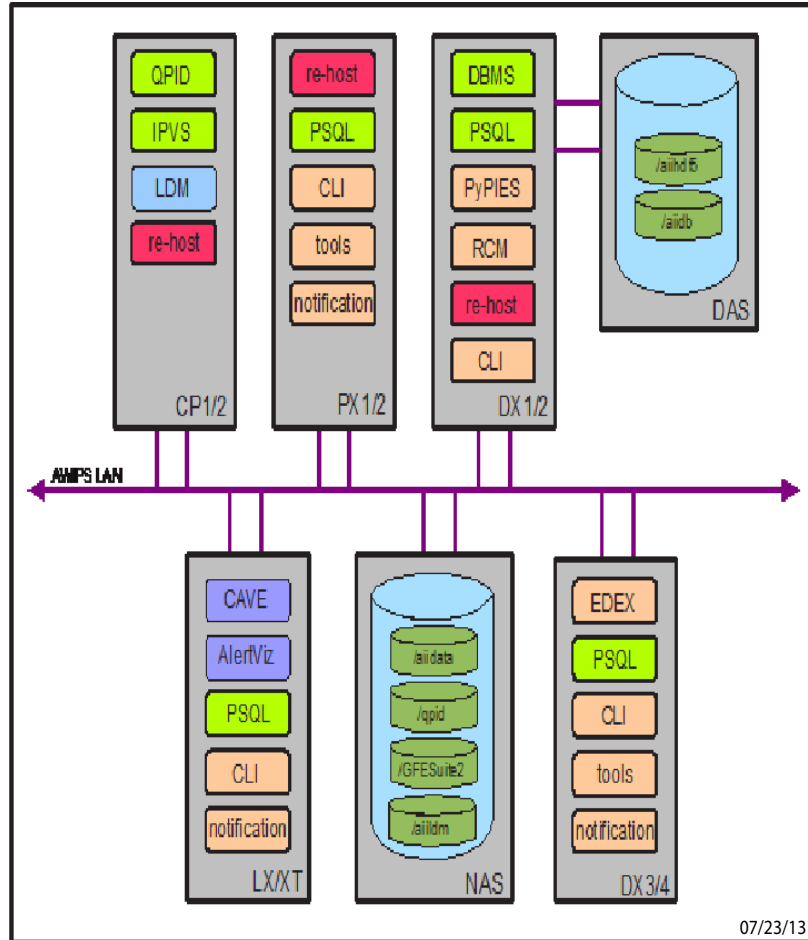

Exhibit 2.7-3. AWIPS II Servers Overview

AWIPS II installs new AWIPS II-specific software on several of the existing AWIPS systems, both servers and workstations.

Table 2.7-1 lists the specific AWIPS II-provided software installed on each system.

Table 2.7-1. AWIPS II Software

System	Key Software Packages
CPSBN1 and CPSBN2	LDM, DVB, QPID, EDEX Bridge, LDM Writer, IPVS
PX1 and PX2	Rehosted Applications
DX1 and DX2	PostgreSQL Data Base Management System (DBMS), PyPIES (dx2f), Radar-Coded Message (RCM),
DX3 and DX4	EDEX (ingest, ingestGrib, ingestDat, request)
LX Workstations	CAVE, AlertViz, CLI, PSQL, Java, Python
XT Workstations	CAVE, AlertViz, CLI, PSQL, Java, Python

On the servers (CPSBN1 and CPSBN2, PX1 and PX2, and DX1–4) AWIPS II software is installed in /awips2. On the workstations, it is installed in /usr/local/viz.

## 2.8 AWIPS II Server Clustering

AWIPS II server software is generally deployed on pairs of servers in order to maximize processing availability. Various failover strategies are used, as detailed in Table 2.8-1.

**Table 2.8-1. AWIPS II Server Failover Strategies**

Server Pair	Failover Strategy
CPSBN1 and CPSBN2	CPSBN1 and CPSBN2 function as a heartbeat cluster; failover is managed automatically or manually. Note that only a single high-availability package is currently used on this cluster. The package name is a2cp1apps. In failover mode, package execution shifts to the backup server. The a2cp1apps package manages the cp1f floating server name. Note that floating names are available only when the high-availability packages are running; they cannot be used to start or stop the high-availability packages.
PX1 and PX2	PX1 and PX2 function as a heartbeat cluster; failover is managed automatically or manually. PX1 and PX2 normally run separate high-availability packages (a2px1apps on PX1 and a2px2apps on PX2). In failover mode, they shift to the same server. Access to PX1 and PX2 is via floating server names: px1f points to the server running the a2px1apps package; px2f points to the server running the a2px2apps package. The floating server names are available only when the high-availability packages are running; they cannot be used to start or stop the high-availability packages.
DX1 and DX2	DX1 and DX2 function as a heartbeat cluster; failover is managed automatically or manually. DX1 and DX2 normally run separate high-availability packages (a2dx1apps on DX1 and a2dx2apps on DX2). In failover mode, they shift to the same server. Access to DX1 and DX2 is via server name alias: dx1f points to the server running the a2dx1apps package; dx2f points to the server running the a2dx2apps package. The floating names are available only when the high-availability packages are running; they cannot be used to start or stop the high-availability packages.
DX3 and DX4	DX3 and DX4 are independent servers, both of which run the EDEX server software. <b>There is no failover between DX3 and DX4.</b> Both servers are load balanced and share data processing responsibilities; if one server is stopped, the other will pick up the entire data processing load. Processing load balancing between DX3 and DX4 is provided by QPID as data messages are removed from QPID queues and processed by the EDEX instance having available processing capacity. Client request balancing for DX3 and DX4 is managed by Internet Protocol Virtual Server (IPVS) (the pulse service). Both QPID and IPVS run on CPSBN1 and CPSBN2.

As indicated in Table 2.8-1, server name aliasing is used to direct clients to the appropriate member of each cluster. “Appropriate member” generally refers to the server running a specific high-availability package; in the case of DX3 and DX4, however, it refers to an available EDEX process.

AWIPS II server aliases and their target servers are listed in Table 2.8-2. Note that the floating names, e.g., dx1f and px1f, are managed by the high-availability packages; as a result, the floating server names are only available when the packages are running and cannot be used when starting or stopping the high-availability packages.

**Table 2.8-2. AWIPS II Server Aliases**

Server Alias	Target System
dx1f	The server, DX1 or DX2, which is currently running the a2dx1apps high-availability package.
dx2f	The server, DX1 or DX2, which is currently running the a2dx2apps high-availability package. LDM was removed from a2dx2apps and shut down on dx2f.
px1f	The server, PX1 or PX2, which is currently running the a2px1apps high-availability package.
px2f	The server, PX1 or PX2, which is currently running the a2px2apps high-availability package.
cp1f	The server, CPSBN1 or CPSBN2, which is currently running the a2cp1apps high-availability package. <b>Note:</b> A new awips2-ldm rpm installed on CPs will wrap both upstream and downstream functionality. /data_store is mounted on CPs, pqaact files will now be maintained on CPs, LDM was added to a2cp1apps.
ec, edexcluster	Connections are redirected to DX3 or DX4, based on a least connections strategy. In a least connections strategy, a new connection request is forwarded to the server, DX3 or DX4, currently having the lower number of connections. This alias only applies to connections on port 9581. These connections are managed by IPVS service, which is managed by the a2cp1apps high-availability package, which runs on CPSBN1 or CPSBN2.

## 2.9 Basic AWIPS II Communication Architecture

The AWIPS II ingest and request processes are a highly distributed system; messaging is used for Inter-Process Communication (IPC). Exhibit 2.9-1 shows the basic IPC architecture.

Exhibit 2.9-1 shows the basic lines of communication that are used for IPC in AWIPS II. There are three primary communication channels:

1. Advanced Message Queuing Protocol (AMQP) messages are routed between the various AWIPS II processes via the QPID message broker.
2. Transport Control Protocol (TCP) messages are routed between EDEX and other AWIPS II components.
3. TCP messages from CAVE to EDEX are routed through the IPVS to request load balancing between DX3 and DX4.

Combined with the clustering strategies discussed in section 2.8, “AWIPS II Server Clustering,” the Communication Architecture provides improved system availability and processing load balancing

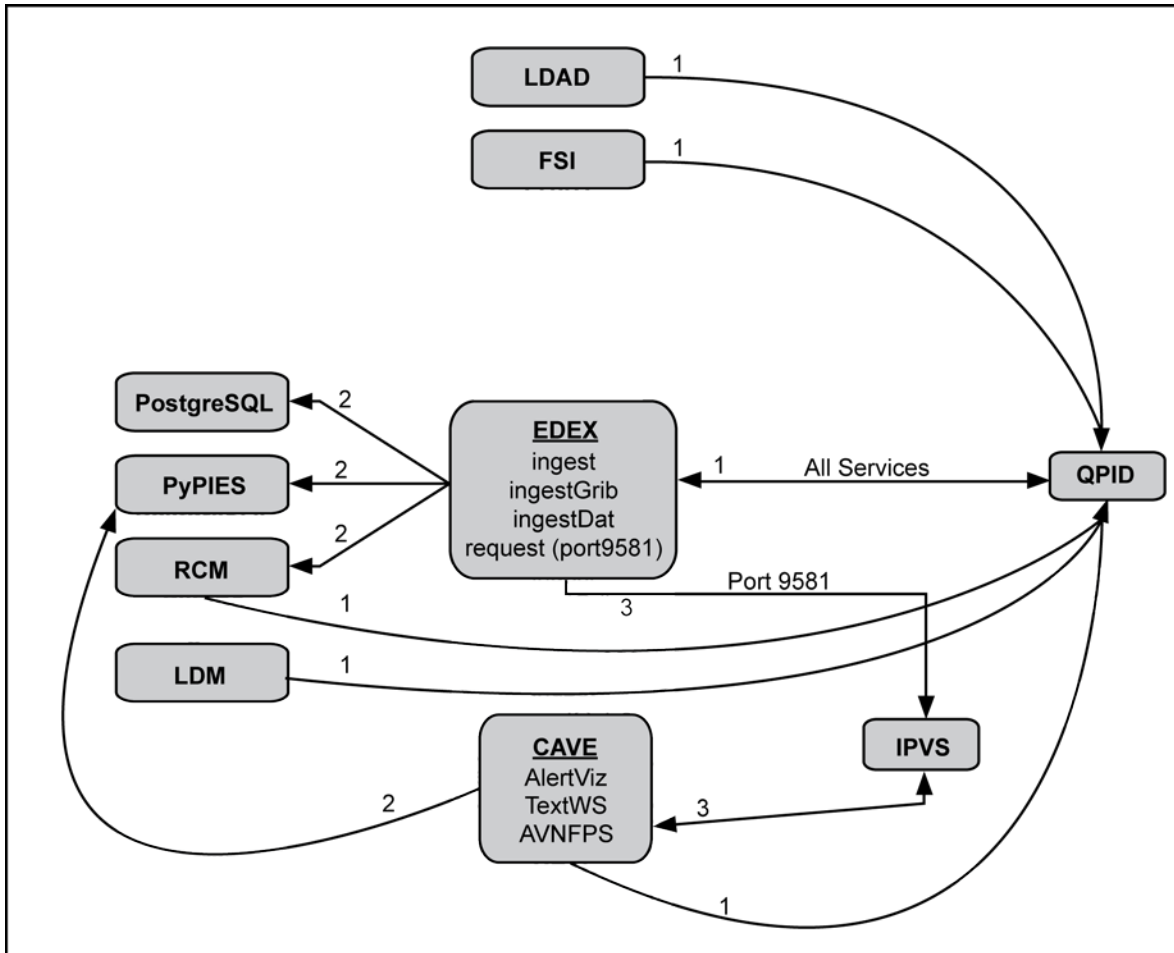

Exhibit 2.9-1. AWIPS II Inter-Process Communication

### 2.10 Basic AWIPS II Logging Architecture

AWIPS II does not implement a standardized logging strategy; rather, each AWIPS II component provides process logs that may be examined to determine process status and assist in system troubleshooting. Table 2.10-1 lists log locations for these components.

For more information on AWIPS II process logging, including log naming patterns and configuration, see the applicable sections of Chapter 25 of this manual.

**Table 2.10-1. Log Locations for AWIPS II Components**

Server	Process	Log Directory
dx1f	Radar Server	/awips2/rcm/data/logs
	PostgreSQL DBMS	/awips2/data /awips2/data/pg_log
dx2f	PyPIES	/awips2/pypies/logs /awips2/http_pypies/var/log/httpd /tmp
	cron	/var/logs Note: logs to <i>cron</i> log.
dx3/dx4	EDEX	/awips2/edex/logs
cpsbn1/ cpsbn2	QPID	/awips2/qpid/log
	LDM	/usr/local/ldm/logs
LX/XT	AlertViz	~/caveData/logs
	CAVE	~/caveData/etc/user/\${USER}/logs

## 2.11 Basic AWIPS II Data Storage Architecture

AWIPS II stores on two shared data servers – the Direct Attached Storage (DAS) server and the Network Attached Storage (NAS) server. Both of these servers provide for shared data access; this provides improved system resiliency in the event of server failure. DAS access is limited to the DX1/2 cluster; NAS access is available from any server or workstation on the Local Area Network (LAN). All systems are mounted to access the data on the NAS. The AWIPS II Raw Data Storage is directly accessible only from NAS; however, other systems – DX1, DX3, and DX4 – also access this data by mounting the NAS. They do so using a file system map to nas1:/data\_store. The primary AWIPS II data storage locations are listed in Table 2.11-1

**Table 2.11-1. AWIPS II Data Storage**

Data Component	Location	Access From
AWIPS II Raw Data Storage	nas2:/data_store	dx1, dx2, dx3, dx4, ax, px, workstations (lx, xt)
AWIPS II HDF5 Data Storage	das1:/aiihdf5	dx2f
AWIPS II Database	das1:/aiidb	dx1f
AWIPS II QPID Shared Data	nas1:/qpid	cp1f
AWIPS II EDEX Shared Data	nas1:/aiidata	dx3, dx4, px1, px2, cpsbn1, cpsbn2
AWIPS II Service Backup	nas1:/GFESuite2	dx1-4, px1-2
AWIPS II Service Backup	nas1:/aiidata/utility	dx1, dx2, ax
AWIPS II Hydroapps and Avnfps Applications	nas1:/aiidata/share	lx, xt
AWIPS II WES ARCHIVE	nas2:/awips2archive	dx1, dx2, dx3, dx4, px1, px2, ax, lx, xt

Note that for mounts that are accessed from a floating server name, e.g., dx2f, the mounts are managed by the high-availability package that provides the floating name. For



example, the mount to DAS1:/aiildm, which is accessed using the dx2f floater, is managed by the a2dx1apps high-availability package.

## 2.12 Basic AWIPS II Visualization Architecture

AWIPS II uses the CAVE application as its main data visualization/manipulation tool. CAVE incorporates a number of the legacy AWIPS I applications such as Display Two-Dimensional (D2D), Graphical Forecast Editor (GFE), and Text Workstation. AWIPS II has also reengineered GUARDIAN into AlertViz. CAVE and AlertViz are installed on both the LX and the XT workstations.

Exhibit 2.12-1 shows the basic visualization architecture.

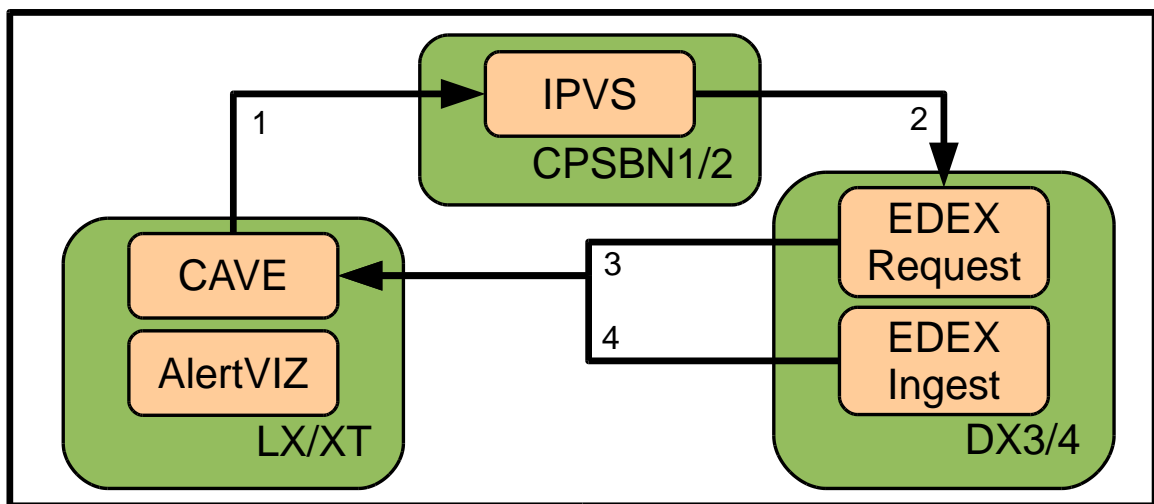

Exhibit 2.12-1. AWIPS II Visualization

Exhibit 2.12-1 shows the basic information/data flow between CAVE and EDEX. AlertViz will display CAVE errors as well as messages from other parts of the system. The information/data flow is as follows:

1. Data requests are sent from CAVE to a virtual server name (ec). The virtual server name is resolved by IPVS.
2. IPVS forwards the data request to the available EDEX Request process on either DX3 or DX4.
3. The EDEX Request process returns the requested data to CAVE.
4. The EDEX Ingest process broadcasts data-ingested messages that are picked up by CAVE.

CAVE can be started in various modes by passing its switches through the command line (or via application launchers). For example, CAVE can be launched to emulate the Text Workstation or only to display the D2D perspective. See SMM Chapter 25 for more information on the CAVE command line switches.

### 2.13 Basic AWIPS II Data Processing Architecture

AWIPS II separates data processing into four logically separate components:

1) data receipt; 2) data decoding; 3) data storage; and 4) data request. These components are distributed over the various systems in AWIPS II. This distribution is designed to provide improved data throughput coupled with improved system resiliency. AWIPS II reuses a number of existing components in data processing.

#### 2.13.1 Basic AWIPS II Data Receipt Architecture

AWIPS II receives data from three main sources: the Satellite Broadcast Network (SBN); the LDAD network; and the Open Radar Product Generator (ORPG)/Supplemental Product Generator (SPG) network. Regardless of the data source, the received data is fed to data ingest, which is performed by the EDEX software on DX3 and DX4. This basic data receipt concept is shown in Exhibit 2.13.1-1.

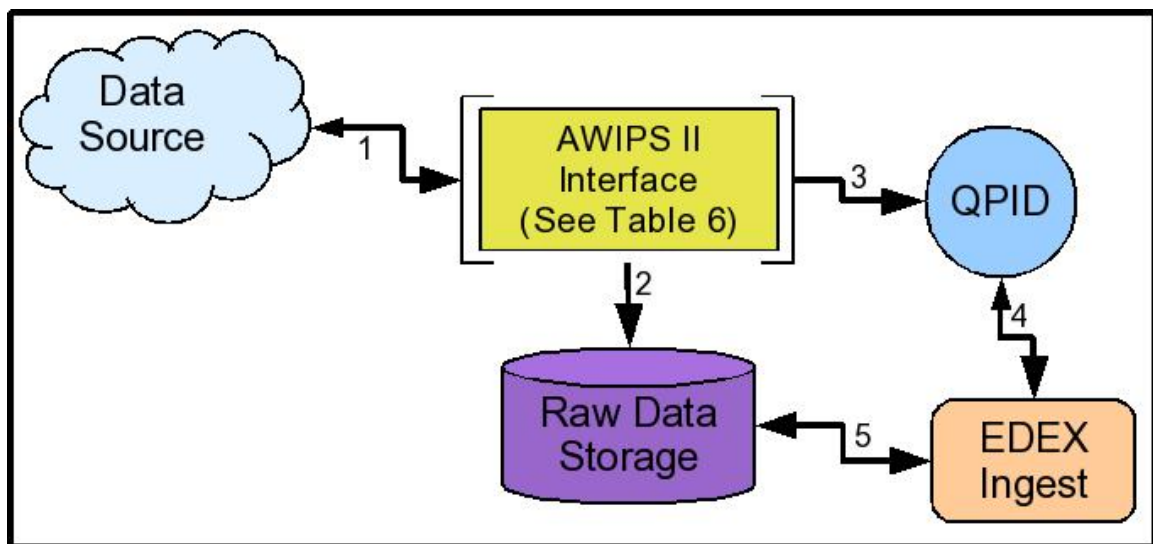

Exhibit 2.13.1-1. AWIPS II Data Receipt

As shown in Exhibit 2.13.1-1:

1. The AWIPS II interface process obtains a data product from the data source.
2. The interface process writes the data to a file in Raw Data Storage.
3. The interface process posts a “data available” message to the QPID message broker.
4. The EDEX Ingest process obtains the “data available” message from QPID and removes the message from the message queue.
5. The EDEX Ingest process obtains the data file from Raw Data Storage.

AWIPS II either modifies or provides interfaces between the existing AWIPS components and AWIPS II data ingest. The AWIPS II interfaces are shown in Table 2.13.1-1.

**Table 2.13.1-1. AWIPS II Interfaces to Data Sources**

Source	AWIPS II Interface
SBN	LDM obtains data from the SBN on CPSBN1/2 cluster. LDM writes the data to a file in Raw Data Storage and posts a “data available” message to the QPID message broker on the CPSBN1/2 cluster.
LDAD	LDAD has been modified to feed data into the AWIPS II ingest data flow. Specifically, three new router processes have been added to the LDAD suite on PX1/2. These router processes are routerStoreEDEX, routerShefEncoderEDEX, and routerStoreTextEDEX. These processes allow baseline LDAD data flows to be processed by EDEX.
ORPG/SPG	The Radar Server on the DX1/2 cluster interacts with ORPG/SPG to obtain radar data. When the data is obtained, the server writes the data to a file in Raw Data Storage and posts a “data available” message to the QPID message broker on the CPSBN1/2 cluster.
MHS	AWIPS II can send products to the WAN using the AWIPS1 handleOUP.pl script (/awips/fxa/bin/handleOUP.pl) or the AWIPS 2 handleOUP.py script (/awips2/edex/data/utility/edex_static/base/dissemination/handleOUP.py). The handleoup.dropbox is only used to ingest text products that have been sent using handleOUP.py.

Note that this architecture provides separation between data sources and ingest processing. Any data source that follows this architecture will be able to provide data for EDEX to process.

### 2.13.2 Basic AWIPS II Data Decoding Architecture

Data decoding is defined as the process of converting data from a raw format into a decoded format that is usable by the AWIPS II visualization software. In AWIPS II, data decoding is performed by the EDEX Ingest processes, which run on both DX3 and DX4. The basic data decoding concept is shown in Exhibit 2.13.2-1.

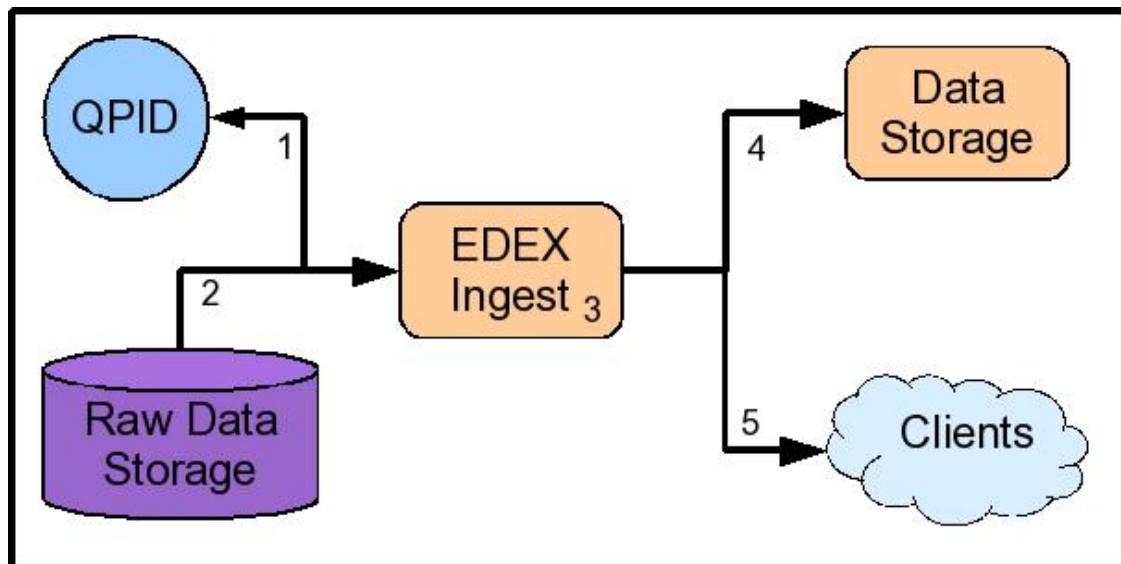
**Exhibit 2.13.2-1. AWIPS II Data Decoding**

As shown in Exhibit 2.13.2-1:

1. The EDEX Ingest process obtains the “data available” message from the QPID message broker. The EDEX Ingest process determines the appropriate data decoder based on the message contents and forwards the message to the decoder. Finally, the message is removed from the message queue.
2. The EDEX Ingest process reads the data from Raw Data Storage.
3. The EDEX Ingest Process decodes the data.
4. The EDEX Ingest process forwards the decoded data to Data Storage.
5. The EDEX Ingest process sends a message to a client queue that decoded data is available.

The current architecture has two EDEX Ingest processors, DX3 and DX4. Load balancing of Ingest processing among multiple Ingest processes is provided by the QPID message broker. Although multiple EDEX Ingest processes are possible, each “data available” message is serviced by whichever EDEX Ingest processor gets the message first. Either EDEX Ingest processor may be taken offline without stopping data ingest.

It is also important to note that in AWIPS II all data types are processed on both Ingest Processors. Although a specific data file is processed by a single EDEX Ingest process, data files for a data type are processed on both Ingest processors.

Once this process is complete, clients may obtain and perform additional processing on the data. This includes display of the data in CAVE, additional processing such as SmartInit scripts that are run on Gridded Binary (GRIB) data, text watch/warn triggered scripts, etc.

### ***2.13.3 Basic AWIPS II Data Storage Architecture***

AWIPS II provides data storage in two areas – Raw Data Storage and Processed Data Storage. These two data storage areas use a combination of PostgreSQL database tables, HDF5 files, and raw data files to store data.

Raw Data Storage contains the raw data that has been received from various data sources. The Raw Data Storage area is physically located on the AWIPS II NAS.

Processed Data Storage contains the decoded data. Processed Data Storage also hosts a collection of static data such as topological and map data. Most of this data is physically stored on either the AWIPS II Network Attached Storage (NAS) or the DAS device. The Processed Data Storage area is maintained by EDEX.

#### ***2.13.3.1 AWIPS II Raw Data Storage***

AWIPS II Raw Data Storage is contained in a file system on the AWIPS II NAS. The EDEX Data Servers (DX1, DX2, DX3, and DX4), CPSBN, the PX servers and AX servers, and the LX and XT workstations mount Raw Data Storage off NAS. Raw Data

Storage is mounted on /data\_store on all these systems. The accessibility of the Raw Data Storage is shown in Exhibit 2.13.3.1-1.

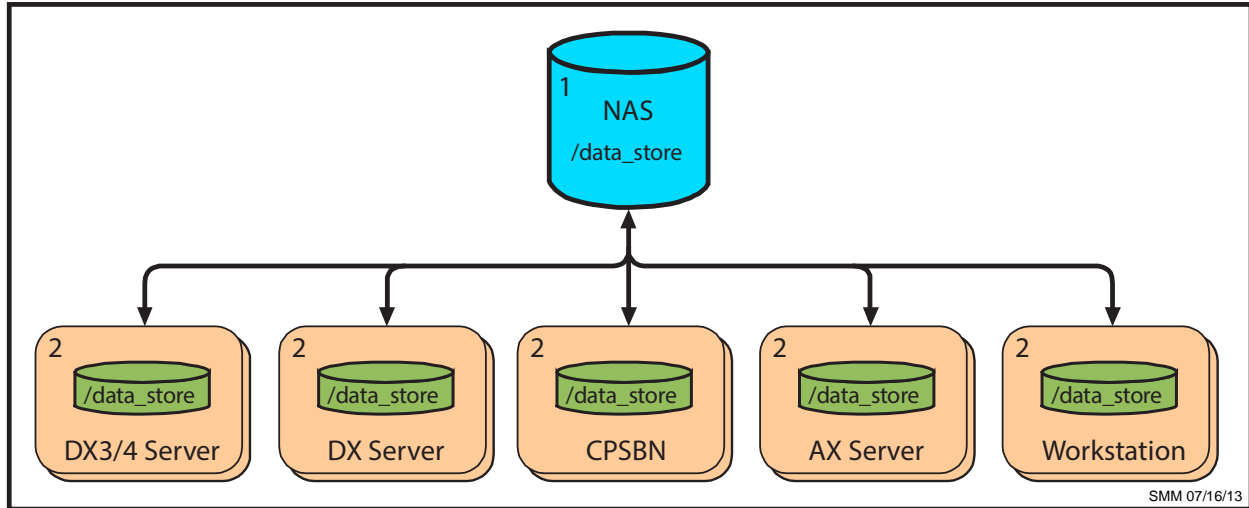

**Exhibit 2.13.3.1-1. AWIPS II Raw Data Storage**

As shown in Exhibit 2.13.3.1-1:

1. AWIPS II Raw Data Storage is located in NAS [NAS2].
2. All the hosts (DX1, DX2, DX3, DX4, AX, CPSBN, and Workstations) mount volume off NAS.

The basic structure of Raw Data Storage is

**/data\_store/<data type>**

The directory structure under each data type as well as the file names used for the raw data are determined by the configuration of LDM.

Procedures for verifying the mount points are presented in Chapter 25 of this manual.

**Verifying Raw Data Storage:** Access to Raw Data Storage is via an NFS file system mounted on /data\_store on the various servers, and the LX and XT workstations. Although this procedure will work from any workstation, most of the steps will be performed from DX3.

The “quick and dirty” method of checking for files in Raw Data Storage is to use the find command to search for recent files and then filter to extract specific information. The basic find command is `find <root> -mmin -<minutes> -type f`. This will produce a list of files in Raw Data Storage that were recently modified. To make the list manageable, it will be piped into cut to isolate the data type. The results will be written to a text file, and duplicates will be eliminated using a combination of sort and uniq. In the end, what is produced is a list of recently stored data types in Raw Data Storage.

Note that in this procedure, certain intermediate results are written to files in /tmp; to avoid overwrites, use your initials as the output file extension (e.g., file-name.XXX, where XXX are your initials).

Find all recent data types for which files exist in the Raw Data Store, writing the results to a temporary file.

```
dxl-ntca{rschup}107: find . -mmin -10 -type f | cut -d '/' -f 2 > /tmp/available.RJS
```

Sort the contents of the data type file, writing the results to a temporary file.

```
dxl-ntca{rschup}108: sort /tmp/available.RJS > /tmp/sorted.RJS
```

Eliminate duplicates in the sorted list, writing the results to a temporary file.

```
dxl-ntca{rschup}109: uniq /tmp/sorted.RJS /tmp/ingest-types.RJS
```

Display the resulting data types.

```
dxl-ntca{rschup}110: cat /tmp/ingest-types.RJS
binlightning
bufirmosLAMP
bufrncwf
bufrua
cwa
cwat
fog
fssobs
gfe
grib
ldadhydro
ldadmsonet
lsr
modelsounding
obs
preciprate
qpf
radar
redbook
satellite
scan
sfcobs
vil
```

### ***2.13.3.2 AWIPS II Processed Data Storage***

The AWIPS II Processed Data Storage is used to store decoded data. The decoded data is stored in a PostgreSQL database and/or HDF5 files, depending on the type of data. (Processed data storage is covered in Chapters 4 – 7; techniques for checking data storage are covered in Chapter 25.) The basic structure of the Processed Data Storage is shown in Exhibit 2.13.3.2-1.

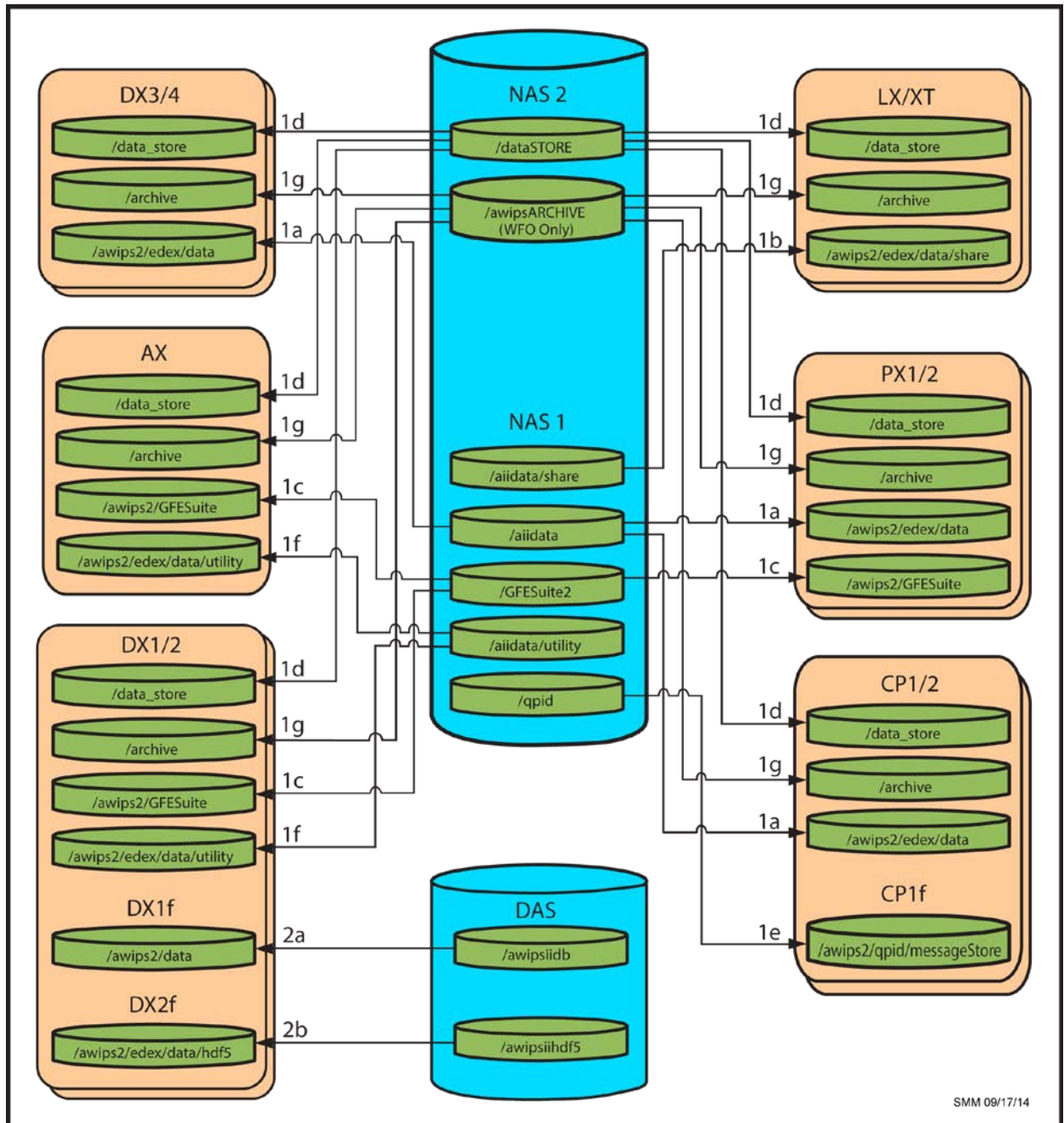

**Exhibit 2.13.3.2-1 AWIPS II Processed Data Storage**

As shown in Exhibit 2.13.3.2-1, Processed Data Storage is located on the DAS and NAS (NAS1 and NAS2) devices. Note that file systems on the DAS are accessible only from the DX1/2 cluster.

1. On the NAS, two file systems contain portions of Processed Data Storage. The two file systems are /aiidata and /GFESuite2.



- a. Processes on DX3/4, PX1/2 and CPSBN1/2 have access to the entire NAS1:/aiidata file system via NFS mount on /awips2/edex/data. This provides access to the Localization Store, hydro applications, and static data.
  - b. Processes on the LX and XT workstations have access to the share portion of the NAS1:/aiidata file system via NFS mount on /awips2/edex/data/share. This provides access to hydro applications and aviation climo data.
  - c. Processes on DX1/2/3/4 servers and PX1/2 servers have access to the NAS1:/GFESuite2. This provides access to the Service Backup and Inter-Site Coordination (ISC) functionality.
  - d. Raw Data Storage (NAS2:/data\_store): All the hosts (DX1, DX2, DX3, DX4, CPSBN, AX and Workstations) mount volume off NAS2.
  - e. QPID shared data (NAS1 /qpid) is accessed from CP1f.
  - f. /aiidata/utility (NAS1) is accessed from DX1/2 and AX.
  - g. /awipsARCHIVE (NAS2) -WFO only: DX1, DX2, DX3, DX4, PX1, PX2, CPSBN1/2, AX and LX/XT.
2. On the DAS, two file systems contain portions of Processed Data Storage. The two file systems are /aiihdf5 and /aiidb.
    - a. Processes on DX1f have access to the DAS:/aiidb file system via local mount on /awips2/data. This provides access to the PostgreSQL database tables.
    - b. Processes on DX2f have access to the DAS:/aiihdf5 via local mount on /awips2/edex/data/hdf5. This provides access to HDF5-based data storage for decoded imagery, forecast grids and point data.

Note that client applications such as CAVE do not directly access the HDF5 files in Processed Data Storage. Rather, CAVE interacts through the EDEX Request process and PYPIES, as shown in Exhibit 2.13.3.2-2.

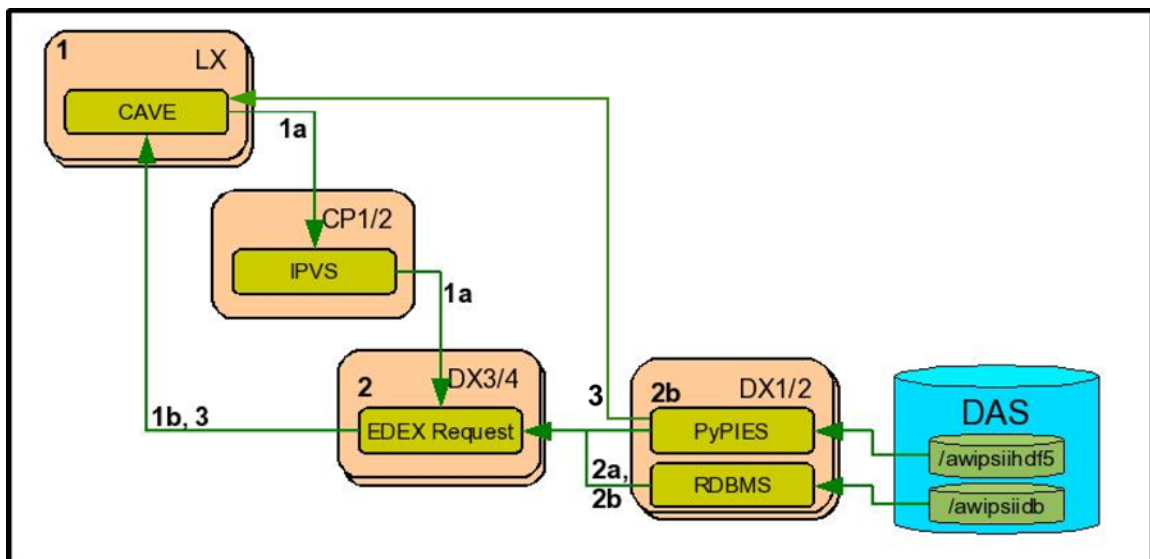

Exhibit 2.13.3.2-2. CAVE/Processed Data Storage Interaction

As shown in Exhibit 2.13.3.2-2, CAVE data retrieval is based on data type and consists of the following:

1. CAVE sends a data request to an EDEX Request process on DX3 or DX4. [**Note:** When loading satellite and radar data, CAVE will work with the request (which works with postgres) to get a list of the datauri it wants and then CAVE will go through pypies to retrieve that data. For point data, like obs, CAVE will ask request for that data, and it will get the requested data from postgres and then pypies, and then send it back to the requesting CAVE. GFE data interaction also works this way, simply because of the strict transaction control needed for that data.]
  - a. On the CP cluster, IPV5 simply forwards the connection request to either DX3 or DX4. Note that EDEX is not aware of the IP aliasing.
  - b. Once the connection is made, EDEX and CAVE communicate directly.
2. The EDEX Request process obtains metadata and data from Processed Data Storage.
  - a. Metadata is obtained from the PostgreSQL database (DBMS).
  - b. Depending on the data type, data is retrieved from the PyPIES server (a2dx2) or the PostgreSQL database.
    - i. Imagery, point data, and gridded data are retrieved from the PyPIES server.
    - ii. Other decoded data, such as text products, are retrieved from the PostgreSQL database.
3. The data and metadata are returned to CAVE for display. Note that the response is directly from EDEX Request to CAVE; it does not pass through IPV5. CAVE is also capable of inserting data into Processed Data Storage. HDF5 data is delivered directly from PyPIES to the requesting CAVE client

Procedures for verifying access to Processed Data Storage are presented in Chapter 25.

### 2.13.3.3 *PyPIES (Python Process Isolated Exchange Storage)*

PyPIES was created for AWIPS II to isolate the management of HDF5 Processed Data Storage from the EDEX processes. PyPIES manages access, i.e., reads and writes, of data in the HDF5 files. In a sense, PyPIES provides functionality similar to a DBMS; all data being written to an HDF5 file is sent to PyPIES, and requests for data from an HDF5 file are processed by PyPIES.

PyPIES is implemented in two parts:

1. The PyPIES manager is a Python application that runs as part of an Apache HTTP server on dx1f. It is the PyPIES manager that handles requests to store and retrieve data. The Apache HTTP server provides request management and isolates the HDF5 read/write to a separate process.
2. The PyPIES logger is a Python process that coordinates logging.

PyPIES is controlled by the httpd-pypies System V script; it is part of the a2dx2apps high-availability package.

#### 2.13.4 Basic AWIPS II Data Retrieval Architecture

Data retrieval is the process used by an AWIPS II client to obtain data with the EDEX Servers. In making the data retrieval, the client interacts with an EDEX Request process; the Request process obtains the requested data from the Processed Data Store and returns it to the client. The basic data retrieval process is shown in Exhibit 2.13.4-1.

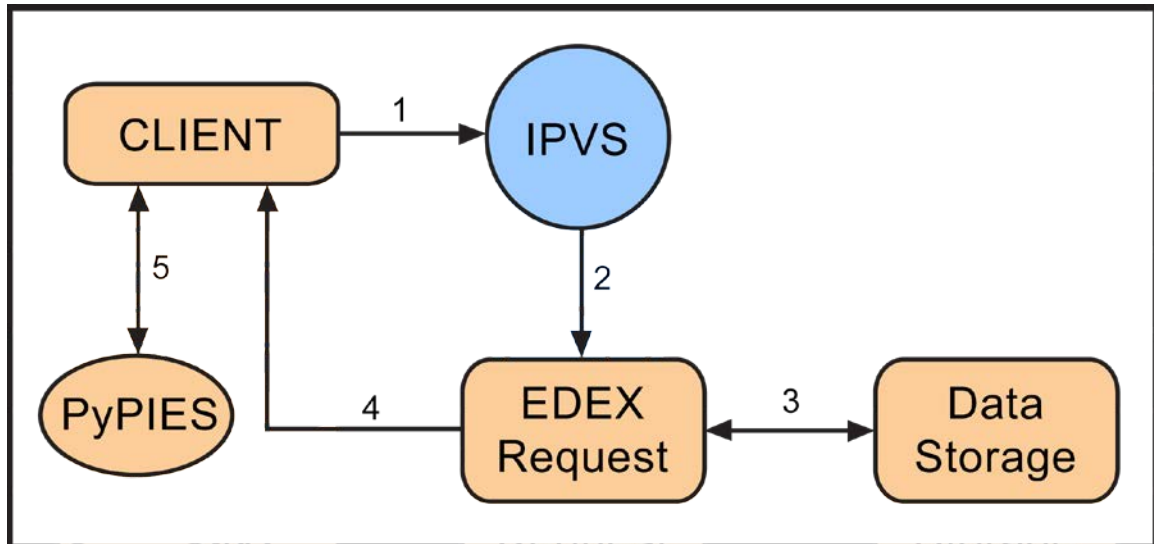

Exhibit 2.13.4-1. AWIPS II Data Retrieval

As shown in Exhibit 2.13.4-1:

1. The client sends a request via TCP protocol to a virtual host name managed by IPVS.
2. IPVS forwards the request, which includes the return address of the client, to an available EDEX Request process.
3. The EDEX Request process obtains the requested metadata from the AWIPS II database.
4. The EDEX Request process forwards the requested metadata directly to the client.
5. If the client has requested data which resides in hdf5 store, then it communicates directly with PyPIES on dx2f to retrieve the necessary information to visualize the data.

This architecture allows the client access via any available EDEX Request process, resulting in improved system reliability and accessibility.

#### 2.14 Basic AWIPS II Data Retransmission Design

AWIPS II uses the sequence numbers provided by the SBN to implement an automated retransmission capability for missed products delivered by the SBN. The retransmission

capability has been implemented via a daemon process, `sbn_retransmit`, which is installed as part of the LDM installation on the CPSBN1/2 cluster. The AWIPS II Message Retransmission Design is shown in Exhibit 2.14-1. Notice that AWIPS II reuses most of the existing retransmission infrastructure. [Note: All channels except GOES support automatic retransmission. GOES does not because the NCF software does not support it.]

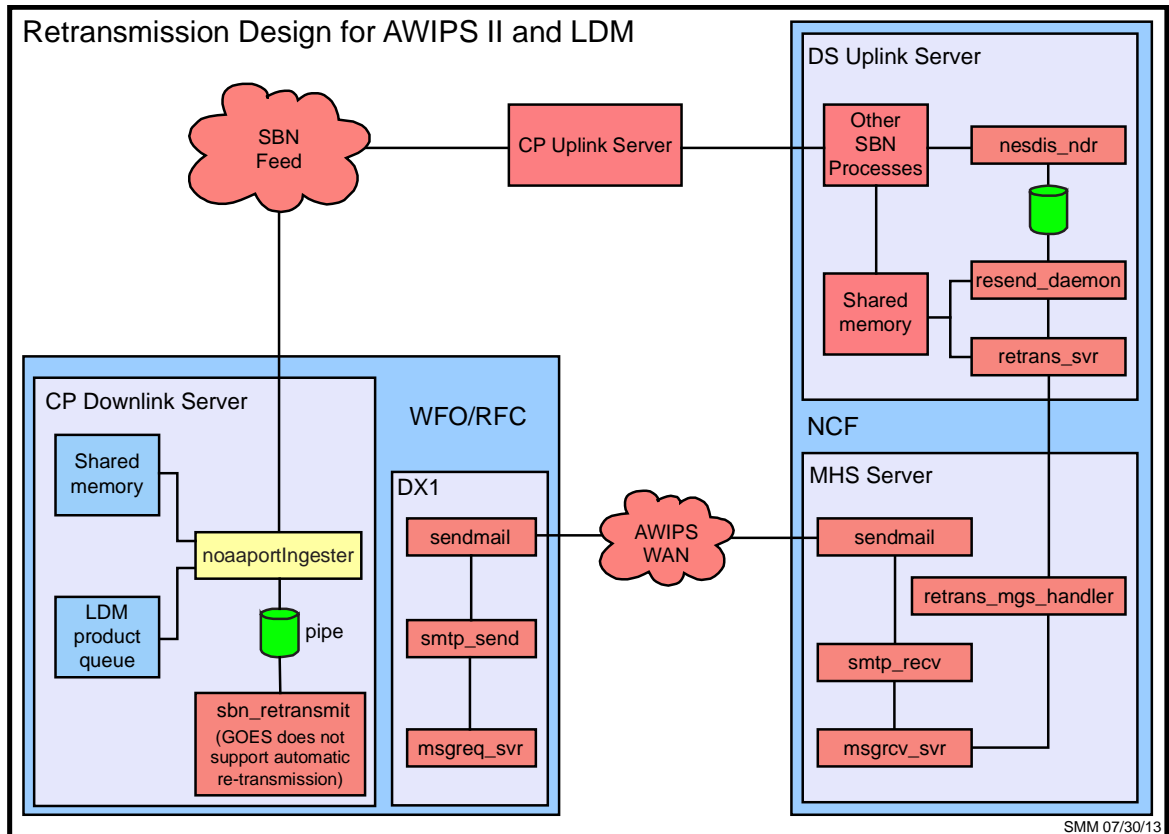

Exhibit 2.14-1. AWIPS II Message Retransmission

To determine if a product retransmission is required, `sbn_retransmit` monitors the LDM product queue. When a gap is detected, `sbn_retransmit` forwards a request to the Network Control Facility (NCF) for a retransmission of the missing products.

### 2.15 Basic AWIPS II Data Purge Architecture

AWIPS II stores data in two separate collections: 1) the AWIPS II Raw Data Storage, which contains unprocessed data; and 2) the AWIPS II Processed Data Storage, which contains decoded and other processed data. These two data collections use different purge mechanisms.

### 2.15.1 AWIPS II Processed Data Storage Purge Architecture

AWIPS II has implemented a data plug-in based purge strategy. The default purge strategy is version-based, similar to AWIPS I's version-based purge strategy. Each data plug-in is able either to use the default strategy or to implement its own strategy. The GFE and text data plug-ins implement their own purge strategies based on the purge strategies used in AWIPS I; all other data plug-ins currently use the default, version-based purge strategy.

Rules for the version-based purge are defined in XML files located in the AWIPS II Localization Store, which is in /awips2/edex/data/utility on DX3/4. See Chapter 11 for more information on the purging and purge rules.

The basic Processed Data Storage purge strategy is shown in Exhibit 2.15.1-1.

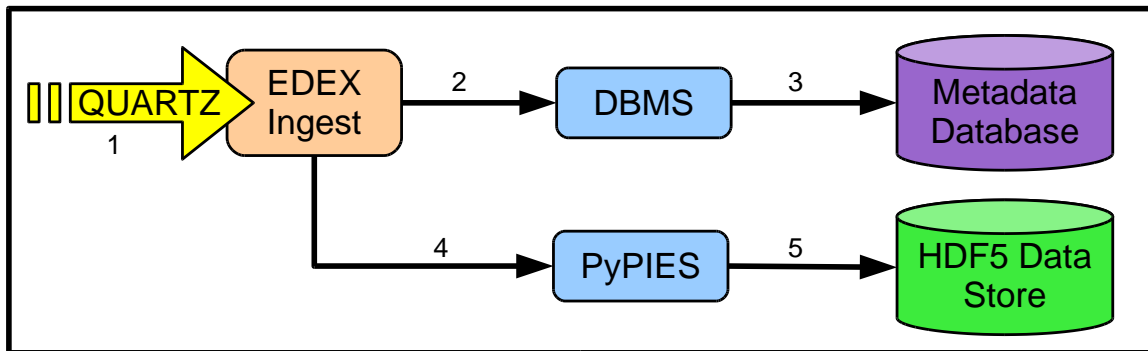

Exhibit 2.15.1-1. AWIPS II Processed Data Storage Purge

As shown in Exhibit 2.15.1-1:

1. A quartz event is triggered in the EDEX Ingest process causing the Purge Service to execute.
  - a. The EDEX Purge Service obtains a purge lock; if the lock is already taken, the Purge Service exits. This strategy ensures that only a single EDEX Ingest process actually performs the purge.
  - b. The EDEX Purge Service obtains the purge rules for each data plug-in.
2. The EDEX Purge Service sends a delete message to the PostgreSQL DBMS.
3. The PostgreSQL DBMS deletes the data from the database table(s).
4. If HDF5 data is to be purged, the EDEX Purge Service sends a purge message to the PyPIES service.
5. The PyPIES service deletes the data from the HDF5 file(s).

### 2.15.2 AWIPS II Raw Data Storage Purge Architecture

AWIPS II Raw Data Storage is purged by EDEX based on entries in RAW\_DATA.xml.

**Note:** Starting 13.5.3 release, a brand-new and customizable archiving capability is provided. It populates an archiving staging area (/archive) on an hourly basis with extracts from the database (.bin files) and compressed versions of the HDF files. It also includes an archive purge function so that both raw and processed data can remain on the real-time system for up to 7 days. This function replaces the LDM scour. From the 7-day storage (also known as the rollover), a new case generation GUI saves data cases so they can be transferred to other media for long-term storage or to the WES-2 Bridge for later viewing or playback.

## 2.16 AWIPS II Localization Store

AWIPS II uses a Base/Site/User model for localizing/customizing software. The Localization Store consists of a directory structure (/aiidata/utility) that is visible at /awips2/edex/data/utility on the EDEX Data Servers (DX 3 and DX4). When CAVE is started on an LX workstation (or as the *Text Workstation* application on an XT workstation), CAVE obtains the latest localization information from the EDEX Request process and updates the local localization cache, found in <user-home>/caveData. This caching mechanism allows CAVE to: 1) use the latest available localization data for operation; and 2) utilize the same user data on any workstation. CAVE's localization interaction is shown in Exhibit 2.16-1.

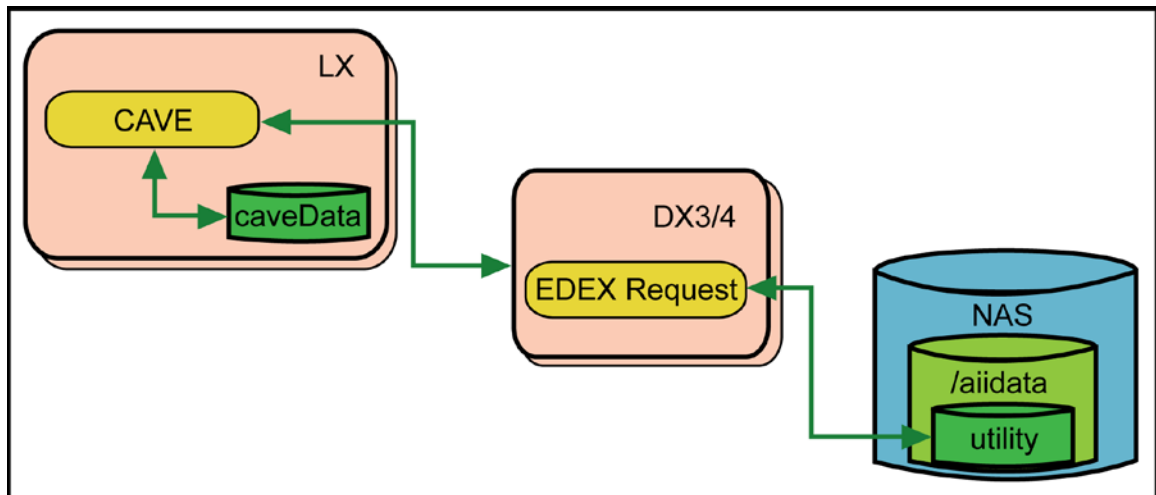

**Exhibit 2.16-1. CAVE/Localization Store Interaction**

As shown in Exhibit 2.16-1, the centralized Localization Store is accessed via the EDEX Request process. This access occurs when CAVE is started and as files for the site localization are modified. Prior to requesting a localization file, the cached copy in caveData is checked for currency; the file is requested from EDEX only if the cached copy is out of date. In that case, the file from the Localization Store overwrites the local copy.

Modification of a site's localization is performed using the Localization Perspective in CAVE. Any changes made using the Localization Perspective are propagated back to the Localization Store.

[**Note:** Do not manually modify files located under caveData; manual changes are not propagated to the Localization Store and will be overwritten when CAVE is restarted.]

## 2.17 EDEX Distribution Files

Distribution files tell EDEX how to invoke a decoder plugin on a raw data file. The base files are in `/awips2/edex/data/utility/edex_static/base/distribution/`. Site-level files are in `/awips2/edex/data/utility/edex_static/site/<your site>/distribution`. Each plugin has a distribution file that contains the files that the plugin can process.

Raw files are written to `/data_store`, and a message is sent via QPID to the EDEX distribution service from either the LDM (a2cp1apps), the RadarServer, or LDAD. The distribution service compares the file header that is sent in the message against the regular expressions in every distribution file. When it finds a match, the raw file is placed in a queue for the matching plugin to decode and process. The distribution files are used to match file headers as well as filenames, which is how files dropped into EDEX's manual endpoint (`/awips2/edex/data/manual`) are processed. Because the RadarServer actually writes its raw files according to the AWIPS I radar directory structure (`/data_store/radar/<radarid>/<product mnemonic>/...`) those files would have to be renamed before being dropped into the manual endpoint for manual reprocessing.

For example, a particular 0.5 base reflectivity product from the KOAX radar written by the RadarServer would be located in `/data_store/radar/koax/Z/elev0_5/res0_25/az0_5/level256/koax.153.20120106_1625`. (In this filename, the "153" designates the radar product number; in this case, 153 stands for a super-resolution 8-bit base reflectivity product.) By looking at the radar.xml file, which is included in the examples provided in section 2.17.1, you can see that a `koax.*` filename would not be matched. In real-time processing, the radar server adds "RadarServer" to the beginning of the file header sent in the message via QPID (for example, "RadarServer.koax.153.20120106\_1625"). So, if these radar files needed to be manually reprocessed using the manual endpoint for any reason, either a site-level override of the distribution file needs to include a pattern that starts with "koax," or the `koax.*` files need to be renamed to `RadarServer.koax.*` prior to copying them into the manual endpoint.

### 2.17.1 Editing an EDEX Distribution File

Because these files are in `edex_static`, they have to be manually edited using a text editor. You should not edit the base files; rather, you should copy the base version to your site and then edit the site version. The regular expressions in the distribution files need to correspond with the regular expressions in the LDM `pqact.conf` file. If patterns exist in `pqact.conf` but are not in the distribution files, then raw data files will be written to `/data_store` but would never be ingested and processed by EDEX. Entries for these non-ingested files would be written to the unrecognized files log in `/awips/edex/logs`.

Examples follow.

**obs.xml:** Processes any file header that starts with “SA” or “SP”, which should match any WMO header that contains METAR data (e.g., SAUS, SPUS, SACN, SAMX).

```
<requestPatterns xmlns:ns2="group">      <regex>^S[AP].*</regex>
</requestPatterns>
```

**text.xml:** Processes lots of WMO patterns. The second pattern `^S[A-CEG-Z].*` matches any header that starts with “S” except for “SD” or “SF,” so it also matches the “SA” and “SP” files that the obs.xml plugin matches. This means that METARs are processed by both plugins simultaneously.

```
<requestPatterns>      <regex>^[ACFNURW][A-Z].*</regex>      <regex>^S[A-
CEG-Z].*</regex>      <regex>^T[BCX].*</regex>      <regex>^SF[A-OQ-TV-
Z].*</regex>      <regex>^SDUS1.*</regex>      <regex>^SDUS4[1-
6].*</regex>      <regex>^SDUS9[^7].*</regex>
<regex>^SFU[^S].*</regex>      <regex>^SFUS4[^1].*</regex>
<regex>^SFP[^A].*</regex>      <regex>^SFPA[^4].*</regex>
<regex>^SFPA4[^1].*</regex>      <regex>^BMBB91.*</regex>
<regex>^N.*</regex>      <regex>^F[EHIJKLMQVWX].*</regex> </requestPatterns>
```

**radar.xml:** Matches files from the LDM and the RadarServer. Files that match the pattern `^SDUS4[1-6].*` in obs.xml also match `^SDUS[234578].*` in radar.xml. This means that certain radar products that have text data are processed by both plugins. The RadarServer’s file header messages always begin with “RadarServer”; they do not have WMO headers.

```
<requestPatterns >      <regex>^SDUS[234578].*</regex>
<regex>^RadarServer.*</regex> </requestPatterns>
```

**dhr.xml:** Matches a subset of RadarServer files and some of the radar files that arrive over the SBN. The numbers at the end of the RadarServer regular expressions refer to the radar product numbers (32 = DHR, 80 = STP, 138 = digital storm total precip; these numbers are defined in interface control documents published by the Radar Operations Center at <http://www.roc.noaa.gov>).

```
<requestPatterns xmlns:ns2="group">      <regex>^SDUS8. .... .*</regex>
      <regex>^SDUS5. .... .*</regex>      <regex>^RadarServer.*.32</regex>
      <regex>^RadarServer.*.80</regex>
<regex>^RadarServer.*.138</regex> </requestPatterns>
```



## **Chapter 3**

# **Individual User Accounts**

## Chapter 3. Individual User Accounts

### Table of Contents

	<i>Page</i>
3.1 General Guidance on Individual User Accounts.....	1
3.2 Managing Individual User Accounts Using setupAwipsUser.sh.....	2
3.2.1 Creating a New User Account .....	2
3.2.2 Re-Creating Desktop and ssh Keys for an Existing User Account.....	4
3.2.3 Removing an Existing User Account.....	6
3.3 High-Level View of setupAwipsUser.sh .....	6
3.4 Changing User or Device Password Using the Command Line .....	7
3.4.1 Changing Non-Root Accounts .....	7
3.4.1.1 User Change to Password .....	7
3.4.1.2 Root Change to User Account Password .....	8
3.4.2 Changing Root Password on Linux Devices.....	8
3.4.3 Changing NAS CLI and Console Root Passwords .....	8
3.5 Synchronizing SSH Keys with VerifySSHkeys.sh .....	9
3.6 Synchronizing CRS SSH Keys with installCRSssh.sh.....	9
3.7 Recover from a Gnome Screensaver Lockout .....	12
3.8 Limiting access via SSH .....	12
3.9 User Name Procedures.....	12
3.10 Localization Perspective User Roles (userRoles.xml).....	13

Individual user accounts are used to control access to AWIPS. They provide authorized users with a way to log in to AWIPS and use its resources, while maintaining system security.

The AWIPS System Manager sets up individual user accounts. For each user, the same account will be used on both the graphics and the text workstations.

### 3.1 *General Guidance on Individual User Accounts*

User names should follow the convention <first initial><last name>, all lower case. If necessary, the last name should be truncated so that the user name is no more than eight characters long. Use an integer at the end of the user name if necessary to prevent duplication. Examples: **gbush**, **gbush2**, **gwashing**, **gwashin2**.

Account names must:

- Consist of eight or fewer characters
- Start with a letter
- Contain only lower case letters and numbers
- Be unique.

User passwords must be consistent with the following criteria:

Passwords must now be 14 characters, with minimum one each of a digit, upper case, lower case and special characters. The last 5 passwords will be remembered and cannot be reused. Users may not change their password for 7 days after a change. Users will be locked out temporarily after 5 unsuccessful logins in a row.

User accounts inactive for 35 days will be locked. Maximum SSH authentication attempts reduced from 6 to 4. SSH sessions will timeout after 30 minutes of inactivity.

World writable directories (777) will have the sticky bit set. The sticky bit prevents users from being able to delete other user's files from the directory as a security measure. Suggested resolution is to make the directory 775 permissions, and add the users who should be able to delete files from the directory to the group who owns the directory. For example, if the directory is `ldad:ldad`, then add the user to the `ldad` group in `/etc/group`.

**Note:** To check if an account is locked, as user root from the affected workstation:

```
pam_tally2 --user=udavis
```

Or don't include the `--user` option if you just want to see all those who are locked. To reset, type the following as root on the same workstation:

```
pam_tally2 --user=udavis --reset
```

### 3.2 *Managing Individual User Accounts Using setupAwipsUser.sh*

You must use the script `/home/awipsadm/install/setupAwipsUser.sh`, rather than any system GUI or direct calls to command line utilities, to manage individual user accounts. This script can be used to add a new user, remove an existing user, and re-synch ssh for an existing user. This will ensure that the AWIPS workstation software is running in an environment that has been tested and which is supported by the NCF.

The general format of the `setupAwipsUser.sh` command is:

```
setupAwipsUser.sh <username> [PROMPT|REMOVE|<user real name>]
```

Script options are displayed by executing the script with no options.

```
[root@dx1-ntcb install]# ./setupAwipsUser.sh
ERROR : please include a username as a paramater!

USAGE : /home/awipsadm/install/setupAwipsUser.sh <username>
[PROMPT|REMOVE|<real name>]
    <username> can be up to 8 characters
    use PROMPT as the third paramater to make the script interactive
    use REMOVE as the third paramater to disable a user created by this
script
    <real name> is the real name field for /etc/passwd [EXAMPLE: John E.
Doe,x8605]
                                it can be up to 9 space delimited strings

[root@dx1-ntcb install]#
```

#### 3.2.1 *Creating a New User Account*

To create a new individual account for “George Washington,” log on to DX1 as user **root** and execute the following commands:

```
TYPE: cd /home/awipsadm/install
```

```
TYPE: ./setupAwipsUser.sh gwashing "George Washington"
```

**Note:** The new user will be added to `/awips/fxa/data/fxa-users`, but the user will not be removed from this file when the account is removed from the system. Over time, this file will grow and will require manual trimming by the ESA or the ITO.

```
[root@dx1-ntcb install]# ./setupAwipsUser.sh gwashing George Washington
Checking that gwashing is not an existing administrator user name
/usr/local/bin/ssh test to lx1 passes!
We will use lx1 to populate desktop for new account...

Account name entered ----> gwashing

This is a new user account.
Real name entered ----> George Washington
User id entered ----> 127

Setting up account for gwashing...
```

```

*****
NOTE that you must create a password for gwashing!
Then execute /var/yp/ypmake on dx1.

As root on dx1:

    prompt> passwd gwashing
    prompt> /var/yp/ypmake

(gwashing is locked until a password is created.)

*****
pushing out passwd changes via NIS...
gmake[1]: Entering directory `/var/yp/ntcb.awips1'
gmake[1]: `ypservers' is up to date.
gmake[1]: Leaving directory `/var/yp/ntcb.awips1'
gmake[1]: Entering directory `/var/yp/ntcb.awips1'
Updating passwd.byname...
Updating passwd.byuid...
Updating group.byname...
Updating group.bygid...
Updating shadow.byname...
Updating netid.byname...
gmake[1]: Leaving directory `/var/yp/ntcb.awips1'
creating .cshrc for gwashing...
creating .login for gwashing...
creating .sawfishrc for gwashing...
/home/awipsadm/install/GnomeLXdesktop.tar exists not recreating it!
.gnome files
.kde files
fixing desktop files...
Running install-gnome-kde.sh gwashing

Creating gwashing desktop files...
mv: cannot stat `./.gnome2/nautilus-scripts/D2D (lx) - TextWS (xt)': No such
file or directory
mv: cannot stat `./.gnome2/nautilus-scripts/AWIPS start-up menu': No such file
or directory
mv: cannot stat `./.gnome-desktop/zzzztemp\'s Home': No such file or directory
mv: cannot stat `./.gnome2/nautilus-scripts/D2DlxTextWSxt': No such file or
directory
mv: cannot stat `./.gnome2/nautilus-scripts/AWIPSstartupmenu': No such file or
directory
mv: cannot stat `./.gnome-desktop/zzzztempsHome': No such file or directory
mv: cannot stat `./.kde/share/apps/konqsidebarng/entries/zzzztemp.desktop':
No such file or directory
tarring up new desktop and installing into /home/gwashing...

Done creating gwashing desktop...

Updating User's AWIPS Desktop Complete...
setting up /usr/local/bin/ssh keys for gwashing...
Making /home/gwashing/.ssh
Generating public/private dsa key pair.
Your identification has been saved in /home/gwashing/.ssh/id_dsa.
Your public key has been saved in /home/gwashing/.ssh/id_dsa.pub.
The key fingerprint is:
b9:23:75:16:5f:70:fd:90:d1:c3:14:f9:c0:73:f8:65 root@dx1-ntcb
chown: cannot access `/home/gwashing/.gnome/magicdev': No such file or
directory
The key's randomart image is:

```

```

+--[ DSA 1024]-----+
|      .++.=@|
|      .E =B@|
|      .  ..B*|
|      .  .  O|
|      S .    |
|      .      |
+-----+
Adding gwashing to /awips/fxa/data/fxa-users on workstations...
Copying /awips/fxa/data/fxa-users to lx1-ntcb...
Copying /awips/fxa/data/fxa-users to lx2-ntcb...
Copying /awips/fxa/data/fxa-users to lx3-ntcb...
Copying /awips/fxa/data/fxa-users to lx4-ntcb...
Copying /awips/fxa/data/fxa-users to lx5-ntcb...
Copying /awips/fxa/data/fxa-users to xt1-ntcb...
Copying /awips/fxa/data/fxa-users to xt2-ntcb...
Copying /awips/fxa/data/fxa-users to xt3-ntcb...
Copying /awips/fxa/data/fxa-users to xt4-ntcb...
Copying /awips/fxa/data/fxa-users to xt5-ntcb...

done running setupAwipsUser.sh...
[root@dx1-ntcb install]#

```

### 3.2.2 Re-Creating Desktop and ssh Keys for an Existing User Account

The script can be used to regenerate the desktop and ssh keys for an individual user. You will be prompted to continue.

```

[root@dx1-ntcb install]# ./setupAwipsUser.sh gwashing George Washington
Checking that gwashing is not an existing administrator user name
/usr/local/bin/ssh test to lx1 passes!
We will use lx1 to populate desktop for new account...

Account name entered ----> gwashing

This user account already exists.
Ensuring gid, shell, and home dir are standard for gwashing...

pushing out passwd changes via NIS...
gmake[1]: Entering directory `/var/yp/ntcb.awips1'
gmake[1]: `ypservers' is up to date.
gmake[1]: Leaving directory `/var/yp/ntcb.awips1'
gmake[1]: Entering directory `/var/yp/ntcb.awips1'
Updating passwd.byname...
Updating passwd.byuid...
Updating netid.byname...
gmake[1]: Leaving directory `/var/yp/ntcb.awips1'
creating .cshrc for gwashing...
creating .login for gwashing...

This is an existing user - do you want to rebuild the desktop (y/n)?
y

setupdesktop=y
creating .sawfishrc for gwashing...
/home/awipsadm/install/GnomeLXdesktop.tar exists not recreating it!

```

```

.gnome files
.kde files
fixing desktop files...
Running install-gnome-kde.sh gwashing

Creating gwashing desktop files...
mv: cannot stat `./.gnome2/nautilus-scripts/D2D (lx) - TextWS (xt)': No such
file or directory
mv: cannot stat `./.gnome2/nautilus-scripts/AWIPS start-up menu': No such file
or directory
mv: cannot stat `./.gnome-desktop/zzzztemp\'s Home': No such file or directory
mv: cannot stat `./.gnome2/nautilus-scripts/D2DlxTextWSxt': No such file or
directory
mv: cannot stat `./.gnome2/nautilus-scripts/AWIPSstartupmenu': No such file or
directory
mv: cannot stat `./.gnome-desktop/zzzztempsHome': No such file or directory
mv: cannot stat `./.kde/share/apps/konqsidebar/entries/zzzztemp.desktop':
No such file or directory
tarring up new desktop and installing into /home/gwashing...

Done creating gwashing desktop...

Updating User's AWIPS Desktop Complete...
setting up /usr/local/bin/ssh keys for gwashing...
Recreating /home/gwashing/.ssh
Generating public/private dsa key pair.
/home/gwashing/.ssh/id_dsa already exists.
Overwrite (y/n)? Your identification has been saved in
/home/gwashing/.ssh/id_dsa.
Your public key has been saved in /home/gwashing/.ssh/id_dsa.pub.
The key fingerprint is:
a8:7e:b0:8d:ee:dc:62:f3:c2:2e:e7:26:53:dd:f5:86 root@dx1-ntcb
chown: cannot access `/home/gwashing/.gnome/magicdev': No such file or
directory
The key's randomart image is:
+--[ DSA 1024]-----+
|          .++.=@|
|          .E =B@|
|          .  ..B*|
|          .  .  o|
|         S .    |
|          .     |
|-----+-----+
Adding gwashing to /awips/fxa/data/fxa-users on workstations...
Copying /awips/fxa/data/fxa-users to lx1-ntcb...
Copying /awips/fxa/data/fxa-users to lx3-ntcb...
Copying /awips/fxa/data/fxa-users to lx4-ntcb...
Copying /awips/fxa/data/fxa-users to lx5-ntcb...
Copying /awips/fxa/data/fxa-users to xt1-ntcb...
Copying /awips/fxa/data/fxa-users to xt2-ntcb...
Copying /awips/fxa/data/fxa-users to xt3-ntcb...
Copying /awips/fxa/data/fxa-users to xt4-ntcb...
Copying /awips/fxa/data/fxa-users to xt5-ntcb...

done running setupAwipsUser.sh...

```

### 3.2.3 Removing an Existing User Account

You will be prompted to enter REMOVE to continue. Edit /awips/fxa/data/fxa-users manually and remove the account on every LX and XT workstation.

```
[root@dx1-ntcb install]# ./setupAwipsUser.sh gwashing REMOVE
Checking that gwashing is not an existing administrator user name

WARNING : YOU ARE ABOUT TO DISABLE gwashing

ARE YOU SURE YOU WANT TO DISABLE gwashing?
enter REMOVE to continue:REMOVE

gwashing BEING DISABLED!

Using userdel on gwashing and then running ypmake
gmake[1]: Entering directory `/var/yp/ntcb.awips1'
gmake[1]: `ypservers' is up to date.
gmake[1]: Leaving directory `/var/yp/ntcb.awips1'
gmake[1]: Entering directory `/var/yp/ntcb.awips1'
Updating passwd.byname...
Updating passwd.byuid...
Updating group.byname...
Updating group.bygid...
Updating shadow.byname...
Updating netid.byname...
gmake[1]: Leaving directory `/var/yp/ntcb.awips1'
Removing gwashing from ax archiver authorized_keys2 file
Removing gwashing from ls ldad authorized_keys2 file

/home/gwashing is being backed up to /home/gwashing.SAVEOLDUSER

gwashing DISABLED!

[root@dx1-ntcb install]#
```

### 3.3 High-Level View of setupAwipsUser.sh

A high-level view of what the setupAwipsUser.sh script does follows. For further details, please review the script itself.

- Prompts for certain information unless that information is provided on the command line (new user's real name [e.g., George J. Washington], account name [e.g., **gwashing**], etc.).
- Creates a new account with shell **/bin/csh** (you can specify **ksh** if your site is an RFC), group **fxalpha** (group ID 200), and home directory in **/home**. It also creates the new home directory.
- Creates the new user's **.cshrc** file. The **.cshrc** will source **\$FXA\_HOME/.cshrc**.
- Creates the new user's **.login** file. The **.login** file will call **xhost** to allow processes running on the server to pop up windows on the user's display.
- Creates a **.sawfishrc** file for the new user. The **.sawfishrc** file will cause F11 key presses or left-clicks on the background (root) window to post the AWIPS menu.



- Installs and configures various Gnome, Sawfish, .KDE, and other setup files and directories to ensure that the user has a standard environment that will work on the AWIPS three-headed graphics workstation and on the text workstation.
- Generates and installs SSH keys so that scripts running under the user's account can transfer files and execute commands remotely.
- Adds the new user name to the D-2D user list maintained in `/awips/fxa/data/fxa-users`.

**NOTE:** You can also use `setupAwipsUser.sh` to reconfigure an existing account for use with AWIPS software. The account's environment files will be overwritten, its home directory may be changed, and its group ID may be changed.

The `setupAwipsUser.sh` script has a number of other options. Please see the header documentation in the script for a description of them.

### 3.4 *Changing User or Device Password Using the Command Line*

User names and device passwords can be changed or updated using a Terminal window and Linux commands. The `/etc/passwd` file should be the same on all devices.

This section provides guidance on changing user or device passwords using the Command line. For the rules on choosing an acceptable password, see section 3.1.

#### 3.4.1 *Changing Non-Root Accounts*

User accounts are controlled through NIS and can be updated by the user or by root.

##### 3.4.1.1 *User Change to Password*

From a workstation, the user can update his or her NIS-controlled password with the `passwd` command.

```
lx1-ntcb{gwashing}102: passwd
Changing NIS account information for gwashing on dx1-ntcb.
Please enter old password:
Changing NIS password for gwashing on dx1-ntcb.
Please enter new password:
Please retype new password:

The NIS password has been changed on dx1-ntcb.

lx1-ntcb{gwashing}103:
```

The user can test the change by performing an `su` to his or her account.

```
lx1-ntcb{gwashing}105: su - gwashing
Password:
lx1-ntcb{gwashing}101:
```

### 3.4.1.2 Root Change to User Account Password

The superuser can change a user account password by updating `/etc/shadow` on the NIS master server (`dx1`) with the `passwd` command and then updating the NIS shadow file with `/var/yp/ypmake`.

```
[root@dx1-ntcb ~]# passwd gwashing
Changing password for user gwashing.
New UNIX password:
Retype new UNIX password:
NIS password could not be changed.
passwd: all authentication tokens updated successfully.

[root@dx1-ntcb ~]# /var/yp/ypmake
gmake[1]: Entering directory `/var/yp/ntcb.awips1'
gmake[1]: `ypservers' is up to date.
gmake[1]: Leaving directory `/var/yp/ntcb.awips1'
gmake[1]: Entering directory `/var/yp/ntcb.awips1'
Updating shadow.byname...
Updating netid.byname...
gmake[1]: Leaving directory `/var/yp/ntcb.awips1'
[root@dx1-ntcb ~]#
```

### 3.4.2 Changing Root Password on Linux Devices

The root account is not under NIS control so the root password must be changed on every AWIPS device. To change root password on the Linux devices, log in to each (LX, AX, DX, and PX) separately as root. A simple loop at the shell prompt from the `dx1` is a fast way to change the root password. **Tip:** You can speed up the process further by typing the root password at the command line prompt, highlighting it with your mouse, and then pressing the middle mouse button when prompted for the root password.

```
[root@dx1-ntcb ~]# for i in $DX_SERVERS $PX_SERVERS ax cpsbn1 cpsbn2
$LX_WORKSTATIONS $XT_WORKSTATIONS
> do
> echo $i
> ssh $i passwd root
> echo
> done
dx1-ntcb
New UNIX password:
Retype new UNIX password:
Changing password for user root.
passwd: all authentication tokens updated successfully.

dx2-ntcb
New UNIX password:
...
```

### 3.4.3 Changing NAS CLI and Console Root Passwords

To change the root password, ssh into `nas1`, `nas2`, `das1`, and `das2` and then use the `passwd` command.

### 3.5 *Synchronizing SSH Keys with VerifySSHkeys.sh*

The VerifySSHkeys.sh script sets up and synchronizes every account's keys across every machine on the platform so that when you log in to any machine, it recognizes your keys. Because it recognizes your keys, you do not need a password between machines. **Please Note:** After running verifySSHkeys.sh the fxa user keys must be re-synchronized with CRS using installCRSssh.sh .

**On DX1 as root,**

**TYPE:**        **cd /home/awipsadm/ssh**

**TYPE:**        **./VerifySSHkeys.sh**

**NOTE:** Make sure that no users are logged on to other servers. Note that it will take up to 10 minutes to execute this script. LDM user has been added to VerifySshKeys.sh so that passwordless ssh works as user ldm between dx1/2 (and other devices) to help maintain local pqact.conf.lll file between devices.

### 3.6 *Synchronizing CRS SSH Keys with installCRSssh.sh*

This installCRSssh script is used only at sites equipped with the Console Replacement System (CRS). AWIPS products configured to be sent to CRS are transferred via ssh. In order to facilitate this communication, AWIPS ssh keys for the fxa user must be installed on the CRS system. Please use caution! Without the correct configuration, NWR messages in AWIPS will not be sent to CRS.

The installCRSssh script will prompt for the root password on the CRS twice. The script assumes that the root password is the same on 0mp and 5mp (configurations). If the passwords are different, then either change the root password on the CRS to match, or contact the NCF for assistance.

The script will then copy over the fxa key to 0mp and 5mp. It will also copy back the rsa key for 0mp and 5mp, and install it in the known\_hosts on each AWIPS device.

**Note:** If any keys are ever regenerated, by running VerifySshKeys.sh, or VIP keys on CRS, then the installCRSssh.sh script must be run again.

For future maintenance of the AWIPS-to-CRS connection, provide the root password of 0mp and 5mp to the NCF.

As user root on **DX1**, follow this procedure:

**TYPE:**        **script -a -f /local/install/installCRSkeys.out**

**TYPE:**        **cd /home/awipsadm/ssh**

**TYPE:**        **./installCRSssh.sh**        (takes about 2 minutes)

**TYPE:**        **exit**

Verify that the script worked correctly. As user fxa on **DX1**:

**TYPE:**        **ssh crs@0mp uname -a**

**TYPE:**        **ssh crs@5mp uname -a**

The commands should succeed without being prompted to enter either 'yes' or a password.

The commands should work on any device as user fxa. If you encounter problems, contact the NCF for assistance.

```
[root@dx1-ntcb ssh]# ./installCRSssh.sh
Starting CRS SSH Key setup, Wed Mar  9 14:17:30 GMT 2011
Compiling CRS authorized_keys file...
Spawning process for CRS host and user keys...
Please type in root password for OMP and 5MP and press enter:
Verify password and press enter:

Attempting to contact OMP...
spawn scp crs@0MP:/usr/local/etc/ssh_host_rsa_key.pub /tmp/crs_0MPkey
crs@0mp's password:
ssh_host_rsa_key.pub                               100% 218
   0.2KB/s   00:00

OMP completed!

Attempting to contact 5MP...
spawn scp crs@5MP:/usr/local/etc/ssh_host_rsa_key.pub /tmp/crs_5MPkey
crs@5mp's password:
ssh_host_rsa_key.pub                               100% 218
   0.2KB/s   00:00

5MP completed!

Attempting to contact OMP...
spawn scp /tmp/crs_userkey crs@0MP:

crs@0mp's password:
crs_userkey                                         100% 1804
   1.8KB/s   00:00
spawn telnet OMP
Trying 165.92.107.241...
Connected to OMP.
Escape character is '^]'.
SCO UnixWare 7.1.1 (OMP) (pts/5)

login: crs
Password:
UnixWare 7.1.1
OMP
OMP{crs} su - root -c 'cp /crs/.ssh/authorized_keys
/crs/.ssh/authorized_keys.bak'
Password:
OMP{crs} su - root -c 'cat /crs/crs_userkey >> /crs/.ssh/authorized_keys'
Password:
OMP{crs} exit
```

```
Connection closed by foreign host.

OMP completed!

Attempting to contact 5MP...
spawn scp /tmp/crs_userkey crs@5MP:
crs@5mp's password:
crs_userkey                                     100% 1804
   1.8KB/s   00:00
spawn telnet 5MP
Trying 165.92.107.242...
Connected to 5MP.
Escape character is '^]'.
login: crs
Password:
UnixWare 7.1.1
5MP
5MP{crs} su - root -c 'cp /crs/.ssh/authorized_keys
/crs/.ssh/authorized_keys.bak'
Password:
5MP{crs} su - root -c 'cat /crs/crs_userkey >> /crs/.ssh/authorized_keys'
Password:
5MP{crs} exit
Connection closed by foreign host.

5MP completed!
Editing AWIPS hosts ssh_known_hosts files...
ax done
cpsbn1 done
cpsbn2 done
dx1-ntcb done
dx2-ntcb done
dx3-ntcb done
dx4-ntcb done
lx1-ntcb done
lx2-ntcb done
lx3-ntcb done
lx4-ntcb done
lx5-ntcb done
px1-ntcb done
px2-ntcb done
xt1-ntcb done
xt2-ntcb done
xt3-ntcb done
xt4-ntcb done
xt5-ntcb done
ls2 done
ls3 done
Finished with CRS SSH Key setup, Wed Mar  9 14:18:36 GMT 2011
[root@dx1-ntcb ssh]#

dx1-ntcb{fxa}9: ssh crs@omp uname -a
UnixWare OMP 5 7.1.1 i386 x86at SCO UNIX_SVR5
dx1-ntcb{fxa}10:
dx1-ntcb{fxa}10: ssh crs@5mp uname -a
UnixWare 5MP 5 7.1.1 i386 x86at SCO UNIX_SVR5
dx1-ntcb{fxa}11:
```

### 3.7 *Recover from a Gnome Screensaver Lockout*

If a locking screen saver is running on a workstation and the password holder is not available, there are two ways to bring the workstation back into service:

- Kill the gnome server and thereby force a logout.

**TYPE:**            **[Ctrl][Alt][Backspace]**

- The gnome server and all its clients (D2D, for example) will be killed. In a few seconds you will have a new login screen.

**NOTE:** This method is strongly discouraged for routine logouts because it may cause problems with the AWIPS application software (undeleted temporary files, open socket connections, etc.). All currently known cases where an abnormal exit causes future problems have been fixed, but it is impossible to test for every situation.

OR

- Kill the screen saver.

If a locking screen saver is running on an AWIPS workstation, there will be one or more processes called **gnome-screensaver** running. If you log into the locked workstation from another workstation and kill all of those processes, the screen savers will disappear and you will be able to continue with the login session that was previously locked.

The **gnome-screensaver** processes are owned by the account that logged in to the workstation. You can kill them only if you are logged in on that account or on the **root** account. Effectively, that means that only **root** can use this method, because, if you could log in to the user account with the password, you could unlock the screen saver in the normal way.

### 3.8 *Limiting access via SSH*

Item 6.2.13 from the RHEL CIS security initiative mandates the limiting of SSH access. The following four fields have been added to `/etc/ssh/sshd_config`:

AllowUsers

AllowGroups

DenyUsers

DenyGroups

### 3.9 *User Name Procedures*

The user name procedures are stored in two places:

/home/<username>/caveData/etc/user/<username>/procedures and  
 /awips2/edex/data/utility/cave\_static/user/<username>/procedures

### 3.10 Localization Perspective User Roles (userRoles.xml)

This section provides an overview of the following topics as they pertain to managing user roles with respect to the ability to localize CAVE: implementation of user roles and overrides of user roles; base and site locations of the userRoles.xml file, which controls user access to files in the localization perspective; how to edit the userRoles.xml file; and the structure and syntax of the userRoles.xml file.

- **Implementation and Overrides of User Roles¶**

**Implementation:** User File.

**Site Override:** Offices are able to create a site override of this file.

- **Base File Location¶**

The BASE userRoles.xml file is located in the following directory:

/awips2/edex/data/utility/common\_static/base/roles/

- **Site File Location¶**

To override the userRoles.xml file as site, the base file should be placed in the following directory and modified appropriately:

/awips2/edex/data/utility/common\_static/site/XXX/roles/

- **Editing the File¶**

This file is not accessible in the localization perspective, and must be edited via a text editor on the system.

**Note:** The User Admin GUI helps to manage this file.

- **Structure and Syntax**

A description of the different sections within the file (userRoles.xml) and how they should be used follows.

- **Defining Permissions¶**

Any and all file locations represented in the localization perspective can be defined in userRoles.xml. Each location is defined as a permission (<permission id></permission>). The base file defines all the different file locations for those files accessible from the localization perspective and should not have to be overridden at the local office. For example, the following entry defines permission for the config directory used by AvnFPS.

```
<permission
id="com.raytheon.localization.site/cave_static/aviation/conf
ig"></permission>
```

### ➤ **Creating Users and Assigning Permission to Users ¶**

Once the desired permissions have been identified, the next section defines the users and those permissions assigned to those respective users. By default in the userRoles.xml file, all users have access to certain files in the Localization perspective via this entry:

```
<user userId="ALL">
    <userPermission>com.raytheon.localization.site/common_
static/purge</userPermission>
    <userPermission>com.raytheon.localization.site/cave_st
atic/colormaps</userPermission>
    <userPermission>com.raytheon.localization.site/cave_st
atic/ffmp</userPermission>
    etc.
</user>
```

The file access control provided by this file can be generic or granular. Offices can leave the default providing all users with access to all files, or it can limit user access based on office roles, etc. For example, the following entry gives the GFE Focal Point, jzeltwan, access to the four permissions controlling SITE-level GFE files:

```
<user userId="jzeltwan">
    <userPermission>com.raytheon.localization.site/common_
static/gfe</userPermission>
    <userPermission>com.raytheon.localization.site/cave_st
atic/gfe/combodata</userPermission>
    <userPermission>com.raytheon.localization.site/cave_st
atic/gfe</userPermission>
    <userPermission>com.raytheon.localization.site/common_
static/isc</userPermission>
    etc.
</user>
```

### ➤ **Creating Roles and Assigning Users to Roles ¶**

If you have multiple people performing the same role (i.e., GFE Focal Point), you can set up roles to which you can assign users, rather than creating the same permissions entry for multiple users. So, taking the GFE Focal Point example, first create a role (see the following for an example).

```
<role roleId="GFEFocal">
    <roleDescription>
```



This is the GFE Focal Point Role

```
</roleDescription>

<rolePermission>com.raytheon.localization.site/common_
static/gfe</rolePermission>

<rolePermission>com.raytheon.localization.site/cave_st
atic/gfe/combodata</rolePermission>

<rolePermission>com.raytheon.localization.site/cave_st
atic/gfe</rolePermission>

<rolePermission>com.raytheon.localization.site/common_
static/isc</rolePermission>

</role>
```

And then assign users to the role. In the following example, jzeltwan and dcokely have been assigned to the role of GFE Focal Point:

```
<user userId="jzeltwan">
    <rolePermission>GFEFocal</rolePermission>
</user>

<user userId="dcokely">
    <rolePermission>GFEFocal</rolePermission>
</user>
```

## **Chapter 4**

### **Data Flow Overview**

## Chapter 4: Data Flow Overview

### Table of Contents

	<i>Page</i>
4.1 AWIPS Satellite Broadcast Network and Local Data Grids.....	1
4.1.1 AWIPS Satellite Broadcast Network.....	1
4.1.2 Local Data Grids.....	3
4.2 WSR-88D/Terminal Doppler Weather Radar (TDWR) Network.....	3
4.3 Local Data Processes.....	4
4.4 Data Routing Overview.....	5
4.5 Configuration Files.....	10
4.5.1 LDM Configuration.....	10
4.5.2 EDEX Data Distribution Files.....	10
4.5.2.1 Potential Problems.....	12
4.6 Monitoring Data Ingest.....	13
4.6.1 EDEX Log Types.....	14
4.6.2 EDEX Log Format.....	17
4.7 General Monitoring of the EDEX System.....	20
4.7.1 EDEX Log Event Levels.....	21
4.8 Monitoring the LDM Data Flow.....	23
4.9 Product Identifier.....	30
4.10 Qpid.....	31
4.11 LDM Ingest Checklist.....	33

### List of Exhibits

Exhibit 4.3-1. Code Sharing in AWIPS II.....	4
Exhibit 4.4-1. LDM Data Flow.....	6
Exhibit 4.4-2. Radar Data Flow.....	9

### List of Tables

Table 4.3-1. AWIPS II Software Functional Groups.....	5
---	---

The AWIPS data management system is responsible for the storage, retrieval, and maintenance of meteorological data sets. The various hardware and software components of this system handle data from two primary sources: the AWIPS Satellite Broadcast Network (SBN) and the WSR-1988 Doppler Weather Radar (WSR-88D) network.

#### **4.1 AWIPS Satellite Broadcast Network and Local Data Grids**

##### **4.1.1 AWIPS Satellite Broadcast Network**

The main source of nationally distributed data for AWIPS is the SBN. Hardware components unique to the SBN include the demodulators, the communications processors (CPSBN1 and CPSBN2), and the visible infrared (VIR) switches, which connect the digital video broadcast (DVB) receivers to the communications processor SBNs (CPSBN). Refer to Exhibits 2.2-1, 2.2-2, and 2.2.1-1 in Chapter 2.

Descriptions of the ten channels follow.

**Note:** Sites normally see only the first 5 channels listed below. The ADD channel only exists at sites where Data Delivery is activated. As of now, that is limited to test beds and a few regions. Once Data Delivery is “activated and operational”, then all the sites will be able to see the 6th channel (ADD).

1. **GOES.** The GOES Channel contains information from the GOES East and the GOES West satellites. The GOES East satellite is a data stream consisting of the following imagery products: visible infrared; and water vapor for the Eastern Conterminous United States (CONUS), Puerto Rico, supernational composites, and Northern Hemisphere (NH) composites. The GOES West satellite is a data stream consisting of the following imagery products: visible infrared and water vapor for CONUS, Alaska, and Hawaii as well as supernational composites, and NH composites.
2. **NMC.** From the NWS Telecommunications Gateway (NWSTG), a data stream consisting of model output from the National Centers for Environmental Prediction (NCEP); the observations, forecasts, watches and warnings produced by NWS Forecast Offices; WSR-88D radar products; and most observational data over North America.
3. **NMC2.** The NWSTG2 channel supplements the NWSTG channel. It contains all Model Grid data.
4. **NOAAPORT\_OPT Channel.** This channel's data stream includes GOES DCP data, GMS/GOES-West/GOES-East/METEOSAT-5/METOSAT-7 composites for visible infrared, and water vapor products (every 3 hours), and OCONUS grids.
5. **NMC3.** This channel's data stream includes Polar Satellite data (NPP).
6. **ADD.** This channel contains AWIPS Data Delivery products for subscriptions shared by more than one AWIPS site.
7. **ENC.** This channel is for data that is required to be encrypted before ingesting over the SBN.

8. **EXP.** Experimental Data.
9. **GRW:** This channel is for GOES-R West products.
10. **GRE.** This channel is for GOES-R East products.

Each channel requires its own demodulator.

Under normal conditions, both NWSSTG and NMC2 products and GOES satellite images are obtained from the SBN on CPSBN1. The CP ingest is controlled by the cp1f heartbeat package.

```
[root@cpsbn1-tbdw ~]# S300_stats
cpsbn1-tbdw pid[14692] upd/rfsh(0/30s) GMT Wed Feb 13 13:48:09 2013
                               Start [Wed Feb 13 13:48:09]

                               LAST          START
                               1 sec  AVG          AVG          MAX          MIN
EBNO (per NEST)                11.94        11.94        11.94        11.94
VBER                          0.00e+00      0.00e+00      0.00e+00      0.00e+00
EBNO (per VBER)                10.00        10.00        10.00        10.00
Signal                          54%          54%          54%          54%

RFStatusValid: OK             LOCK Signal: OK             Data: OK

Tot Unlock Signal/Data:      0.0/0.0 secs
Uncorrected DVB Pkts: 0 {+0 last}
LAN Packets:  Rcv=0  XmitErr=0  Drop=0  Xmit=374

IP:10.0.5.10  MAC:00-06-76-05-01-05  Port:6516  (via eth1) Mode: DVBS2
Firmware 2.7 - RF Code(0x0)
SymbolRate=15.119 Ms/s  Freq=1154 MHz (+177 kHz)  Modulation
Code[13]=2/3 8PSK
LNB_Power[0]=OFF
PID_List:      101      102      103      104      105
FreqOff[0xb1] Signal Strength (in DBM)[-48]  C/N=14.6 EbNo=11.9
dvb_stats: End execute
```

A more detailed discussion of the basic data flow follows in section 4-4. In the case of failover, initial download of these products shifts to CPSBN2; refer to Chapter 18, Failover Management Procedures, for details.

The vast majority of products on the SBN can be used without restriction. However, there are three exceptions: binary lightning; ACARS (Aircraft Communications Addressing and Reporting System); and one-degree ECMWF (European Centre for Medium-Range Weather Forecasts) products. Use of these three products is restricted to official duties, which include data utilization for the purposes of analysis/warning/forecast product preparation, research projects, and training. In general, these three products may not be

redistributed to parties outside of NWS, especially on a routine or ongoing basis. Concerning the one-degree resolution ECMWF grids, the following should also be noted:

- First, redistribution of one-degree (high resolution) ECMWF grids from AWIPS is prohibited. This limitation is formalized in a 2007 NOAA/ECMWF inter-agency agreement. The one-degree (i.e., "Hi Res") ECMWF grids in AWIPS are intended for use only in the conduct of official duties within NWS offices and at designated AWIPS test and support sites (such as AWIPS support contractor test beds and the OAR/Global Systems Division AWIPS node). ECMWF products – and products that are directly and exclusively derived from them – may not be accessed from AWIPS for provision to third parties.
- Second, the ECMWF grids should be considered "data of opportunity." By that it is meant that the availability and timeliness of the ECMWF grids could, at times, be somewhat inconsistent or inferior (i.e., relative to other scheduled NOAA operational products). The potential for somewhat-degraded availability and timeliness is related to the external nature of the data source (i.e., the European Center) and the characteristics of some of the intermediate product dissemination legs.

#### **4.1.2 Local Data Grids**

Several gridded data sets are produced on the local AWIPS system rather than being received across the AWIPS SBN:

- GFE: Graphical Forecast Editor
- MPE: Multisensor Precipitation Estimator
- HPE: High-resolution Precipitation Estimator.

#### **4.2 WSR-88D/Terminal Doppler Weather Radar (TDWR) Network**

The WSR-88D and Terminal Doppler Weather Radio (TDWR) radar networks plus a few additional Federal Aviation Administration (FAA) radar sites provide additional data sources for AWIPS. Most sites receive their radar data via TCP/IP; the others have dedicated modems. The hardware components involved in radar acquisitions include the Open Radar Product Generator (ORPG), the Supplemental Product Generator (SPG), the radar modems, and the VIR switches that connect the modems to the Synchronous Communication Processors (CPSYNC).

For sites that receive radar data via TCP/IP, the data enters AWIPS from the ORPG and the SPG via the AWIPS LAN.

For sites that acquire radar data via dedicated modems, CPSYNC1 handles the radar data stream, while CPSYNC2 sits idle. The VIR switches allow the radar data stream to be switched from one CP to the other in the event of a hardware failure. Refer to Chapter 18, Failover Management Procedures, for detailed information.

**Note:** The AWIPS II RadarServer currently only supports "dialing" in the sense that it can make Class 2 connections over TCP/IP (i.e., the AWIPS WAN). Actual X.25-over-modem dial-up is not supported.

### 4.3 Local Data Processes

AWIPS II software is broadly separated into two components: the Common AWIPS Visualization Environment (CAVE) and the Environmental Data EXchange (EDEX).

- CAVE provides an integrated set of tools for data visualization and manipulation.
- EDEX supports data acquisition, decoding, storage, and preprocessing. Both CAVE and EDEX utilize a plug-in architecture to support flexible deployments. All AWIPS II components are Eclipse Rich Client Platform (RCP) plug-ins; thus all AWIPS II components utilize a standard organizational structure. This enables code sharing between CAVE and EDEX.

Most data processing in AWIPS II requires both an EDEX component for decoding, processing, and storing the data and a CAVE component for retrieving, rendering, and manipulating the data. As a result, processing for each data type is generally separated into three parts: 1) a data decoder bundled with EDEX; 2) a rendering component bundled with CAVE; and 3) a common library bundled with both CAVE and EDEX. This three-part approach to data processing is illustrated in Exhibit 4.3-1.

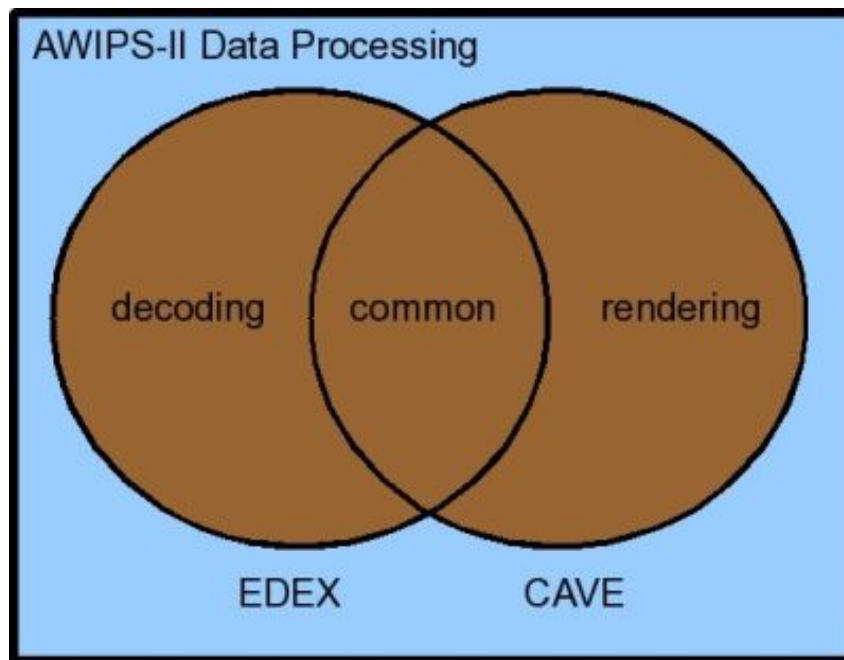

**Exhibit 4.3-1. Code Sharing in AWIPS II**

As a consequence of the architectures chosen, a breakdown of AWIPS II into traditional Computer Software Configuration Items (CSCI) is problematical. A more productive approach is to look at functional groupings of software. Table 4.3-1 contains the mapping of the AWIPS II software into functional groups. This table illustrates how CAVE and EDEX fit into the general Software Functional Group.

**Table 4.3-1. AWIPS II Software Functional Groups**

Functional Group	Description
Installer Projects	Provide support for build component distribution installers for AWIPS II.
Software Build Projects	Provide support for building major software systems.
Static Data Projects	Include static data files, base configuration files, and standard Python scripts.
EDEX Infrastructure Projects	Provide basic Service Oriented Architecture (SOA) infrastructure for EDEX. Also provide some shared (library) projects.
EDEX Data Decoder Projects	Provide EDEX data decoding functionality.
EDEX/AWIPS Interface Projects	Provide runtime interfaces between EDEX and AWIPS software.
EDEX/CAVE Common Projects	Provide a library of functionality and interfaces common to both CAVE and EDEX.
CAVE Core Projects	Provide basic CAVE infrastructure.
CAVE Plug-in Projects	Provide CAVE data rendering functionality.
COTS/FOSS Projects	Provide standard versions of COTS/FOSS software used to support AWIPS

#### 4.4 Data Routing Overview

The LDM data flow, illustrated in Exhibit 4.4-1, is a 12-step process. Descriptions of each step follow.



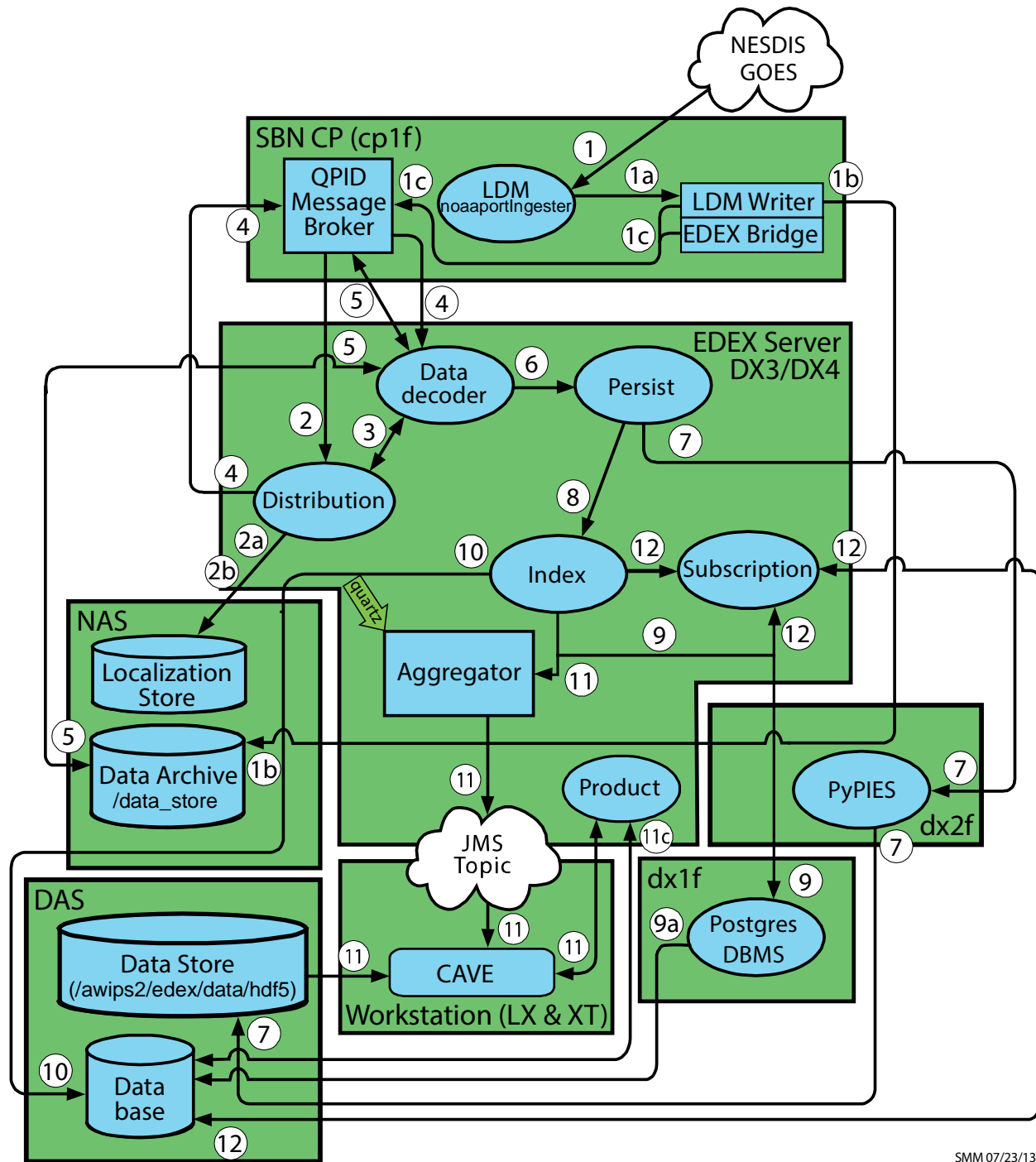

SMM 07/23/13

Exhibit 4.4-1. LDM Data Flow

1. Data is obtained by the LDM noaaportIngester from the SBN.
  - a. The LDM noaaportIngester forwards the product to the LDM Writer instance.
  - b. The LDM Writer instance writes the product to the Data Archive. [Data Archive (/data\_store) directory is mounted on the hosts off the NAS [NAS2].

- c. The LDM writer instance uses the EDEX Bridge to post a message containing product information to the QPID Message Broker. The product information is the WMO header and the path to the product file.
2. The EDEX Distribution endpoint obtains the WMO (World Meteorological Organization) header for the product file identified by the message. The WMO header is matched against data distribution mappings contained in the data distribution directory to determine product routing. (The WMO header is usually included in the message; if it is not, the Distribution service uses the product file name from the message to determine routing.)

**Note:** The files in the data distribution directory are XML (eXtensible Markup Language) files that contain regular expressions which match WMO headers with the appropriate data decoder plug-in.

- a. At EDEX startup, the EDEX Distribution endpoint reads the Data Distribution files from the Data Distribution directory in the Localization Store. It uses the contents of these files to generate the routing table used to determine data routing. The Data Distribution directory is located at `/awips2/edex/data/utility/edex_static/base/distribution`.
- b. The EDEX Distribution endpoint monitors the Data Distribution directory; when a file in that directory is modified, it rereads that file and rebuilds its routing table.
3. The EDEX Distribution Service determines the Data Decoder Plug-In registered to handle the data in the product file.
4. The EDEX Distribution Service forwards the message to the appropriate Data Decoder Plug-In via the QPID Message Broker.
5. The EDEX Data Decoder Service on the EDEX (DX) cluster pulls the message from the QPID Message broker. The Data Decoder Service reads the file pointed to by the message, decodes the data, and determines the appropriate metadata.
6. The decoded data and metadata are sent to the EDEX Persist endpoint.
7. The EDEX Persist endpoint sends the data to PyPIES and PyPIES writes the data to the EDEX data store in HDF5 format.
8. The EDEX Persist endpoint sends the metadata obtained to the EDEX Index endpoint.
9. The EDEX Index endpoint sends the metadata to the PostgreSQL DBMS.
  - a. The PostgreSQL DBMS writes the metadata to the database.
10. The index endpoint does not merely get the dataURI; it also persists the data object to the database. Persistence to the database is executed via a plug-in defined data access object. If the data access object does not override the persistence behavior, then a default persistence strategy is used. The default strategy for persisting data to the database is to first check to see if the data received already exists. If it already exists,

- then persistence to the database is not attempted for that data. If the data is unique, then it is persisted to the database.
11. (Client notification) The Data URI is forwarded to the EDEX URI Aggregator.
    - b. Every 5 seconds the aggregated Data URIs are sent to the JMS Alert Topic.
    - c. CAVE monitors the JMS Alert Topic to obtain a list of available data. CAVE determines if it should render the available data.
    - d. CAVE retrieves metadata from the EDEX server via a product query sent to the EDEX thrift endpoint.
    - e. CAVE retrieves product data from the EDEX server by accessing the EDEX data store's HDF5 files and CAVE renders the data, updating its display as appropriate.
  12. (Subscription) The Data URI is forwarded to the EDEX Subscription endpoint. (This does not apply to Satellite Data Flow.)
    - f. The EDEX Subscription endpoint checks the active subscription list to determine if a subscription has been registered for the product.
      - 1) If no subscription has been registered for the product, no further action is taken.
    - g. The EDEX Subscription endpoint obtains the script information from the database.
    - h. The EDEX Subscription endpoint obtains a micro-engine to execute the script. The micro-engine executes the subscription script for the product.

It is important to note that some, but not all, Radar Products follow a slightly different ingest path. This path is shown in Exhibit 4.4-2. The main differences are as follows:

- The Radar Server on the Database (DX) cluster obtains a Radar product from the ORPG.
- The Radar Server writes the product to the Data Archive.
- The Radar Server posts a message containing product information to the QPID Message Broker.

**NOTE:** Refer to Chapter 7, Ingest of Radar Data, for a more detailed explanation of the Radar data flow.

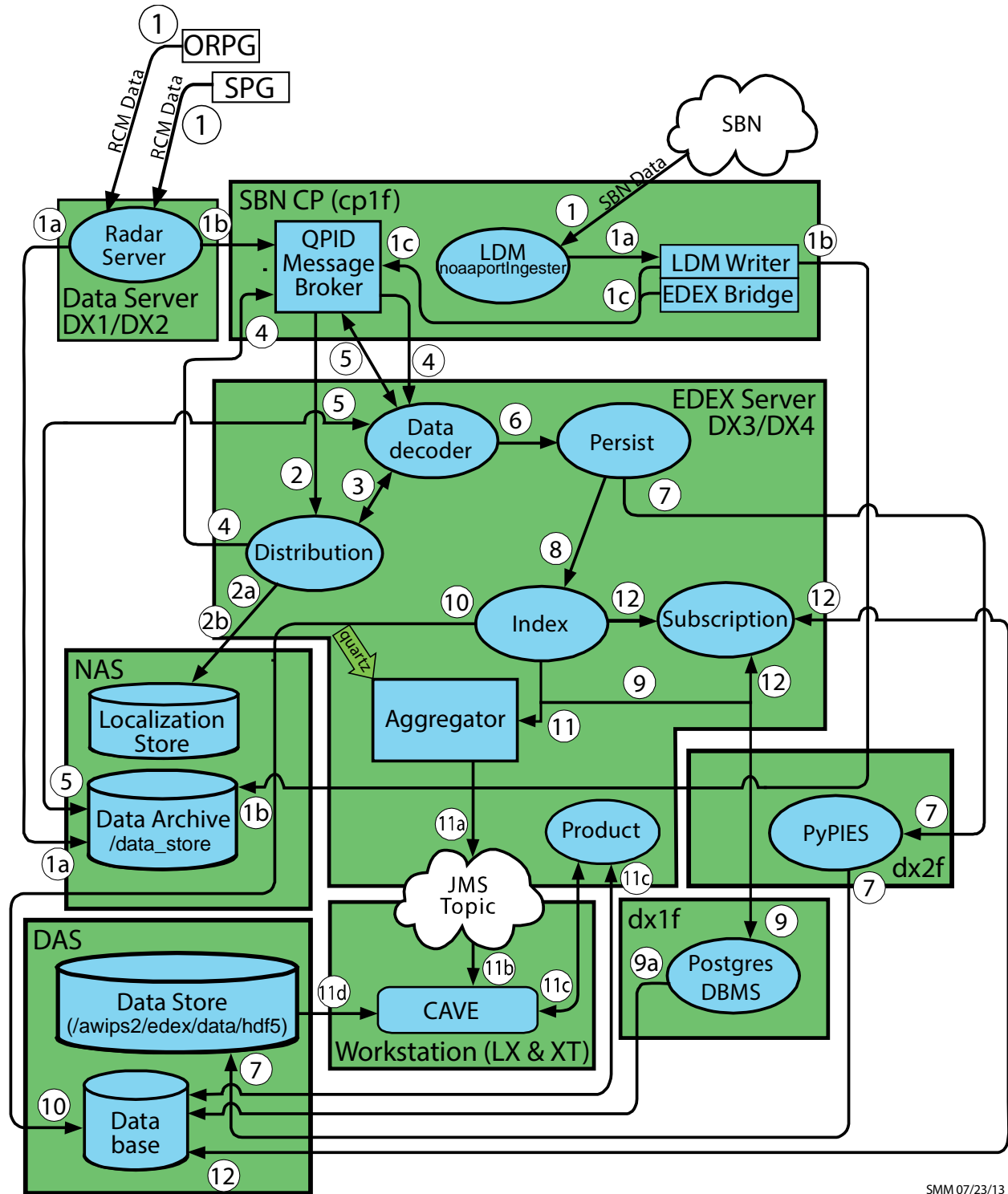

SMM 07/23/13

Exhibit 4.4-2. Radar Data Flow

## 4.5 Configuration Files

Data flow in AWIPS II is controlled by two sets of configuration files: 1) LDM configuration files; and 2) EDEX Data Distribution files. All of these files are normally set at system installation; the files are editable, but extreme care must be taken during editing because malformed files can cause system failure.

The LDM configuration files control the data that is delivered from the SBN to the EDEX Ingest process; the EDEX Data Distribution files control the internal flow of data to the appropriate data decoders.

### 4.5.1 LDM Configuration

LDM server runs only on the SBN CP. It ingests everything from the SBN.

LDM behavior is controlled by the `pqact.conf` file, and the patterns are matched against `pqact.conf`. LDM writes the product to `data_store` and posts a QPID message.

- **pqact.conf** controls how data sent to an instance of LDM is handled. This includes the data types to be handled and the location of the raw data archive.

**NOTE:** Modifying `pqact.conf` will have a severe impact on the data flow.

### 4.5.2 EDEX Data Distribution Files

EDEX Data Distribution files are XML files that are bundled with the EDEX Data Decoders. When EDEX is installed on DX3, DX4, (DX5 and DX6 as it becomes available) the Data Distribution files are installed into `/awips2/edex/data/utility/edex_static/base/distribution`, referred to as the “base distribution directory.” In the standard AWIPS II installation, the base distribution directory is physically located on the Network Attached Storage (NAS); each EDEX installation accesses it via a Network File System (NFS) mount in `/awips2/edex/data`. As a result, changes made to a data distribution file on one of the EDEX servers (DX3 – DX6) will be available on the other EDEX server.

When EDEX is first started, the Distribution Service reads the Data Distribution files and generates a distribution table matching regular expressions with Data Decoders. The regular expressions are defined in the Data Distribution files and are matched against the WMO header of a data file. If the match is met, the file is routed to the data decoder.

**NOTE:** There is one XML distribution file per data decoder. Using regular expressions, each XML file specifies which WMO headers are appropriate for that decoder.

Each Data Decoder has a Data Distribution file in the base distribution directory. The Data Distribution files are named `<data type>.xml`. For example, the Data Distribution file for satellite data is named `satellite.xml`. Each Data Distribution file is a properly formatted XML document with the following format:

```
<?xml version="1.0" encoding="UTF-8" standalone="yes"?>
<requestPatterns xmlns:ns2="group">
  <regex>pattern</regex>
  <regex>pattern</regex>
</requestPatterns>
```

Example for Radar

```
<requestPatterns >
  <regex>^SDUS[234578]. .*</regex>
  <regex>^RadarServer.*</regex>
</requestPatterns>
```

Example for Satellite,

```
<requestPatterns xmlns:ns2="group">
<regex>TI.... ....</regex>
</requestPatterns>
```

The “pattern” in each regex tag is a regular expression that is used to identify a data file. Normally, the regular expression matches the WMO header of the data in the file; it can also match the name of the file containing the data.

For example, satellite.xml contains a single regular expression: TI.... .... (TI, 4 dots, space, 4 dots). Because a dot in a regular expression matches any character, this pattern matches a WMO header starting with the characters TI.

For example: **TIGE04 KNES**

The Distribution Service monitors the base distribution directory. When one of the data distribution files changes, the Distribution Service reads the file and updates its routing table. When the re-read occurs, a message similar to the following message will appear in the EDEX Ingest log file.

```
INFO <date> <time> [<thread>] DISTRIBUTION: Change to
distribution file detected. satellite.xml has been modified.
```

When distribution patterns are reloaded on the D2D, an entry is written to the EDEX Ingest process logs in each of the EDEX servers.

Once the file has been reloaded, the modified patterns are used for file routing.

To understand why and when to edit these files, consider the following: The LDM uses the expressions defined in pqact.conf to determine which data to write to files in the data archive. The LDM generates a message that includes the WMO header information and forwards it to the EDEX Distribution Service via QPID. When the EDEX Distribution Service retrieves the message from QPID, it uses the Data Distribution files in the data distribution directory to determine two things: 1) the data files to process; and 2) the data decoder to process the files.

As a consequence of this action:

- Any time a new entry is placed in the pqact.conf file on the LDM server on the a2cplapps, a corresponding entry must be added, if sufficient pattern doesn't already exist, to the appropriate Data Distribution file in the data distribution directory.
- Any time an entry is removed from the pqact.conf file, it is recommended the corresponding entry should be removed from the appropriate Data Distribution file in the data distribution directory. Failure to do so may result in data loss through the prevention of application launch, or incorrect distribution patterns.

**NOTE:** When making the changes, remember that the files being edited need to be correctly formatted and make sure that there are no typos.

The structure of the message sent to QPID external.dropbox via the EDEX bridge is as follows.

- The WMO header of the data contained in the file, if it is available
- The location of the data file in the data archive
- The start time for the computation of ingest latency
- The destination queue for the message.

The difference between using the manual end point and “external.dropbox” is who produces the message. “external.dropbox” is a message queue within QPID. In order to access “external.dropbox” directly, you need to create an application that can generate the appropriate message. If you do so, you must copy the file into the data archive (or another accessible location – it must be accessible to all servers running EDEX) On the other hand, when you use the manual endpoint, all you do is copy the data file into /awips2/edex/data/manual on DX3/4 and EDEX does the rest.

**NOTE:** You should only copy the file you want to be ingested into the manual inbox. Do not try to interface directly with QPID.

#### 4.5.2.1 Potential Problems

**Problem 1:** What if the manual endpoint does not clean up after itself well? That is, it copies its data to /tmp/sbn/manual; this directory is not purged so it could fill up and cause a system crash.

**Discussion:** This is only a problem if the installation is not performed correctly. EDEX should not be moving files from /awips2/edex/data/manual to /tmp/sbn/manual; it should be moving manually ingested files from /awips2/edex/data/manual to /data\_store/manual. The LDM scour utility should be managing this directory. (Note that this is more of a software issue than a documentation issue. If the reviewer really believes this is a problem he or she should write a ticket (Trac or TTR) to address the issue.)

**Problem 2:** Obviously, using the manual endpoint for data ingest is easier (at the current time) than interfacing with QPID, although a script could easily be written to facilitate using QPID to ingest data (as done in WTDB). What if, because of its ease of use, the manual endpoint becomes the choice of use for local app developers (and in fact for some

regular AWIPS developers for HPE/MPE, LAPS, MSAS, etc.)? The problem is that a regular process that uses the manual endpoint for data ingest compromises the integrity of the data archive.

**Discussion:** If EDEX is configured correctly when it is installed, this is not an issue.

## 4.6 *Monitoring Data Ingest*

All data ingest operations are logged in the EDEX logs on the EDEX (DX3/4) server. In a standard installation, the EDEX logs are located in /awips2/edex/logs. This directory contains several log files; the files starting with “edex-” are the EDEX logs. The files starting with “start-” are the start-up logs. The EDEX logs roll over daily and are date stamped. The naming convention for EDEX logs is edex-{instance name}-yyyymmdd.log.

```
edex-ingest-20130212.log
edex-ingestDat-20130212.log
edex-ingest-gen_areal_ffg-20130212.log
edex-ingestGrib-20130212.log
edex-ingest-purge-20130212.log
edex-ingest-radar-20130212.log
edex-ingest-satellite-20130212.log
edex-ingest-shef-20130213.log
edex-ingest-shef-performance-20130212.log
edex-ingest-smartInit-20130212.log
edex-ingest-text-20130212.log
edex-ingest-unrecognized-files-20130212.log
edex-request-20130212.log
edex-request-productSrvRequest-20130212.log
edex-request-thriftSrv-20130212.log
edex-ingest-archive-20130212.log
edex-ingest-activeTableChange-20130212.log
edex-ingestGrib-activeTableChange-20130212.log
edex-ingestGrib-performance-20130212.log
edex-ingestDat-performance-20130212.log
edex-ingest-performance-20130212.log
edex-request-performance-20130212.log
edex-ingest-gen_areal_qpe-20130212.log
start-edex-ingest-20130212.log
start-edex-ingestDat-20130212.log
start-edex-ingestGrib-20130212.log
start-edex-request-20130212.log
edex-request-hibernate-20130212.log
edex-ingest-hibernate-20130212.log
edex-ingest-ohd-20130212.log
edex-request-textdbSrvRequest-20130212.log
```



```
edex-request-sportlma-20130212.log
edex-ingestGrib-hibernate-20130212.log
```

### 4.6.1 EDEX Log Types

The logs break down into seven different types:

1. **EDEX process logs.** Each EDEX process writes to a separate log. The log file names are `edex-ingest-yyyyymmdd.log`, `edex-ingestDat-yyyyymmdd.log`, `edex-ingestGrib-yyyyymmdd.log`, and `edex-request-yyyyymmdd.log`. These logs contain startup messages and most other messages, including errors, for the EDEX processes. The specific logs that are actually present depend on how EDEX is started.

- `edex-ingestGrib-<yyyyymmdd>.log`  
edex-ingestGrib handles the Grid Products.
- `edex-ingest-satellite-<yyyyymmdd>.log`  
edex-ingest-satellite handles the Satellite products.
- `edex-ingest-radar-<yyyyymmdd>.log`  
edex-ingest-radar handles the Radar products.
- `edex-ingest-text-<yyyyymmdd>.log`  
edex-ingest-text handles other products (metar, sfccobs, etc.).
- `edex-ingest-<yyyyymmdd>.log` (edex-ingest handles other products (lightning, MOS, etc.).  
`edex-ingest-activeTableChange-<yyyyymmdd>.log` (activeTableChange)  
`edex-ingest-gen_areal_ffg-<yyyyymmdd>.log` (Flash Flood Guidance)  
`edex-ingest-gen_areal_qpe-<yyyyymmdd>.log` (QPE)
- `edex-ingestDAT-<yyyyymmdd>.log` (edex-ingestDAT handles backend data services for the Decision Aid Tools, such as FFMP and SCAN)
- `edex-request-sportlma-<yyyyymmdd>.log` (sportlma)

**Note:** Requests to the thrift service no longer go to the `edex-request` log; they go to the log `edex-request-thriftSrv`. This consists of most of the requests from CAVE and a few requests from python command line utilities, such as some GFE items. The `productSrv` (aka `uengine`) service is unchanged and therefore will be still logging to the old place (a few spots in CAVE and localapps still use `productSrv`). The `thriftSrv` log contains a log entry for every request received. In the past these were only logged if it took longer than 200 ms; now, every request is logged. Requests from CAVE include the workstation id, which indicates the user (`<username>`), network address (`<lx3-tbw3>`), process name (`<CAVE>`), process id (`<17176>`), etc., and a unique identifier string. On the CAVE side, the

console log has an entry for each request that takes one second or more to complete. This log entry also contains the unique identifier, so when CAVE reports a slow request, it can be matched to an edex entry on dx3 or dx4 by finding the matching unique id in their logs.

2. **Data type-specific logs.** Logs with names similar to edex-ingest-<data-type>-yyyymmdd.log contain messages relating to a specific data type. These include both status messages and error messages. For a data type having its own log file, this is the log to examine to find and diagnose problems. The ingest-shef log file describes the shef decoder, although it is fed by the NWSTG feed.
3. **edex-ingest-unrecognized-files log.** This log is probably among the most important of them all. The edex-ingest-unrecognized-files-yyyymmdd.log can be checked to determine if data ingest is failing due to a problem with distribution files. Unfortunately, the unrecognized file log only identifies the file that was unrecognized; it does not provide a path to the file.
4. **EDEX startup logs.** Files with names starting with “start” capture messages generated by the *edex\_camel* service script. They are start-edex-ingest, start-edex-ingestGrib, start-edex-ingestDat, and start-edex-request logs. In normal operation, these log files will be zero size.
5. **\*-activeTableChange-\*.log files.** These log files are written to when the active table is updated. This will normally only happen in ingest and request JVMs. These logs were added to see what changes are (or are not) being made to the active table.
6. **\*-performance-\*.log files.** These files are used to log performance-related information to allow the users to determine how long operations are taking in order to find performance issues or to verify if they are meeting performance metrics.
7. **\*-gen\_areal\_qpe-\*.log files.** These logs are written to during the generation of qpe mosaics. When the qpe grids from the RFCs are combined into a mosaic image, the process is logged in the gen\_areal\_qpe logs.
8. **hibernate files.** The hibernate log file will now be produced for each EDEX instance. Any errors produced by org.hibernate will be logged to this file. This log file should primarily be referenced whenever there are persistence errors in the EDEX instance logs.

The log file is a plain ASCII text file and can be viewed using any text viewing utility such as *more*, *less*, *view*, or *tail*.

To get a general view of processing, open a terminal session to the server and enter the following commands:

On DX3/DX4:

**TYPE:** `cd /awips2/edex/logs`

**TYPE:** `date +%F`

2013-02-12

**TYPE:** `ls edex-*20130212*`

edex-ingest-20130212.log  
edex-ingestDat-20130212.log  
edex-ingest-gen\_areal\_ffg-20130212.log  
edex-ingestGrib-20130212.log  
edex-ingest-purge-20130212.log  
edex-ingest-radar-20130212.log  
edex-ingest-satellite-20130212.log  
edex-ingest-shef-20130213.log  
edex-ingest-shef-performance-20130212.log  
edex-ingest-smartInit-20130212.log  
edex-ingest-text-20130212.log  
edex-ingest-unrecognized-files-20130212.log  
edex-request-20130212.log  
edex-request-productSrvRequest-20130212.log  
edex-request-thriftSrv-20130212.log  
edex-ingest-archive-20130212.log  
edex-ingest-activeTableChange-20130212.log  
edex-ingestGrib-activeTableChange-20130212.log  
edex-ingestGrib-performance-20130212.log  
edex-ingest-performance-20130212.log  
edex-request-performance-20130212.log  
edex-ingestDat-performance-20130212.log  
edex-ingest-gen\_areal\_qpe-20130212.log  
start-edex-ingest-20130212.log  
start-edex-ingestDat-20130212.log  
start-edex-ingestGrib-20130212.log  
edex-ingest-ohd-20130212.log  
edex-request-textdbSrvRequest-20130212.log  
start-edex-request-20130212.log  
edex-request-hibernate-20130212.log  
edex-ingest-hibernate-20130212.log  
edex-request-sportlma-20130212.log  
edex-ingestGrib-hibernate-20130212.log

**For ingestGrib,**

**TYPE:** `tail -f edex-ingestGrib-20130212.log`

**For Satellite,**

**TYPE:** `tail -f edex-ingest-satellite-20130212.log`

**For Radar,**

**TYPE:** `tail -f edex-ingest-radar-20130212.log`

**For Archive,**

**TYPE:** `tail -f edex-ingest-archive-20130212.log`

**For GFEPerformance,**

**TYPE:** tail -f edex-ingest-GFEPerformance-20130212.log

**For hibernate,**

**TYPE:** tail -f edex-ingest-hibernate-20130212.log

**For activeTableChange,**

**TYPE:** tail -f edex-ingest-activeTableChange-20130212.log

**For areal\_qpe,**

**TYPE:** tail -f edex-ingest-gen\_areal\_qpe-20130212.log

**For sportlma,**

**TYPE:** tail -f edex-ingest-sportlma-20130212.log

**For other products (refer to Chapter 6),**

**TYPE:** tail -f edex-ingest-20130212.log

**TYPE:** tail -f edex-ingest-text-20130212.log

**4.6.2 EDEX Log Format**

To monitor a specific ingest stream, a little understanding of the logging strategy used by EDEX is required. After ingest of each data file is complete, the ingest endpoint prints a single line to the EDEX system log. The format of the log entry is

**INFO <<date-time>> [thread] Ingest: <<type>>:: <<file name>> <<statistics>>**

Where,

<<date-time>> is the date-time stamp (format yyyy-mm-dd hh:mm:ss,ttt)

[thread] identifies the Camel thread that ran the decoder.

<<type>> identifies the data type, e.g., grib, radar.

<<file name>> is the path to the file that was processed, including the unique product sequence number.

<<statistics>> lists the ingest statistics for the file. There are two statistics provided: *process time* and *latency*. (See note at the end of this section for more information on latency.)

A typical log entry for a grib product in edex-ingestGrib-YYYYMMDD.log is

```
INFO 2014-09-02 00:00:48,435 [Ingest.GribDecode-2] Ingest:
EDEX: Ingest - grib2::
```

```
/data_store/grib2/20140901/23/RUC2/GRID130/2300Z_F015_HGHT-
LHDZ12_KWBG_012300_67711271.grib2.2014090200 processed in:
0.0800 (sec) Latency: 0.1270 (sec)
```

The information from this entry is formatted as:

```
Date: 2014-09-02
Time: 00:00:48
Thread: [Ingest.GribDecode-2]
Type: grib2
Path to File:
/data_store/grib2/20140901/23/RUC2/GRID130/2300Z_F015_HGHT-
LHDZ12_KWBG_012300_67711271.grib2.2014090200
Sequence Number: 67711271
Process Time: 0.2800 (sec)
```

```
Latency: 0.2860 (sec)
```

A typical log entry for Satellite in edex-ingest-satellite-YYMMDD.log is

```
INFO 2016-04-15 00:09:45,086 [Ingest.Gini-1] Ingest: EDEX:
Ingest - satellite:: /data_store/sat/20160415/00/GOES-
15/0000Z_IR_8km_AK-NATIONAL-
TIGB02_KNES_89233006.satz.2016041500 processed in: 0.0750
(sec) Latency: 0.1060 (sec)
```

```
INFO 2016-04-15 00:09:51,099 [Ingest.Gini-1] Ingest: EDEX:
Ingest - satellite:: /data_store/sat/20160415/00/GOES-
15/0000Z_VIS_8km_AK-NATIONAL-
TIGB01_KNES_89233034.satz.2016041500 processed in: 0.0910
(sec) Latency: 0.1110 (sec)
```

```
INFO 2016-04-15 00:11:22,939 [Ingest.Gini-1] Ingest: EDEX:
Ingest - satellite:: /data_store/sat/20160415/00/GOES-
15/0000Z_WV_4km_WEST-CONUS-
TIGW05_KNES_250978.satz.2016041500 processed in: 0.0910
(sec) Latency: 0.1030 (sec)
```

A typical log entry for Radar in edex-ingest-radar-YYMMDD.log is

```
INFO 2014-09-02 00:00:04,116 [Ingest.Radar-1] Ingest:
EDEX: Ingest - radar-sbn::
/data_store/radar/20140901/23/KUEX/N0Q/KUEX_N0Q_012359-
SDUS53_KGID_404789659.rad.2014090200 processed in: 0.0340
(sec) Latency: 0.0500 (sec)
```

```
INFO 2014-09-02 00:00:05,155 [Ingest.RadarRadarServer-1]
Ingest: EDEX: Ingest - radar-local::
/data_store/radar/kfdr/SRM/elev3_4/res1/level16/kfdr.56.201
40901_2355 processed in: 0.0220 (sec) Latency: 0.0310 (sec)
```

A typical log entry for products like metar, MOS in edex-ingest-text-YYMMDD.log is

```
INFO 2015-01-28 00:00:01,368 [Ingest.Text-1] Ingest: EDEX:
```

```

Ingest - text::
/data_store/summaries/20150127/23/AWUS83_KBIS_272359_829433
441.2015012800 processed in: 0.0060 (sec) Latency: 0.0340
(sec)

INFO 2015-01-28 00:00:08,954 [Ingest.Text-2] Ingest: EDEX:
Ingest - text::
/data_store/forecast/20150128/00/FTAG01_SABM_280000_8294336
29.2015012800 processed in: 0.0290 (sec) Latency: 0.0470
(sec)

INFO 2015-01-28 00:03:01,462 [Ingest.Text-1] Ingest: EDEX:
Ingest - text::
/data_store/metar/20150128/00/SAIR32_OIII_280000_829438196.
2015012800 processed in: 0.0010 (sec) Latency: 0.0230 (sec)

INFO 2015-01-28 00:03:13,964 [Ingest.Text-2] Ingest: EDEX:
Ingest - text::
/data_store/shef/20150128/00/FGUS51_KWOH_280002_829438729.2
015012800 processed in: 0.0050 (sec) Latency: 0.3410 (sec)

INFO 2015-01-28 00:03:13,808 [Ingest.Text-1] Ingest: EDEX:
Ingest - text::
/data_store/maritime/20150128/00/SXUS23_KWNB_280000_8294386
38.2015012800 processed in: 0.0030 (sec) Latency: 0.2800
(sec)

INFO 2015-01-28 00:03:13,955 [Ingest.Text-2] Ingest: EDEX:
Ingest - text::
/data_store/upperair/20150127/23/UDAS02_BABJ_272358_8294387
21.2015012800 processed in: 0.0070 (sec) Latency: 0.3320
(sec)

```

A typical log entry for all other products (e.g.: binlightning ) in edex-ingest-YYMMDD.log is

```

INFO 2015-08-24 00:00:27,345 [Ingest.binlightning-1]
BinLightningDecoder: EDEX -
/data_store/binlightning/20150823/23/SFPA41_KWBC_232358_370
53073.nldn.2015082400 - decoding as bit-shifted data

INFO 2015-08-24 00:00:27,345 [Ingest.binlightning-1]
BinLightningDecoderUtil: EDEX -
getBitShiftedDataStrikeCount(): found 2 groups of bit-
shifted data pattern, which contains 117 strikes.

ERROR 2015-08-24 00:00:27,345 [Ingest.binlightning-1]
BinLightningDecoder: EDEX - Discarding data with invalid
bin range of 20150823235854 to 20200830001700

INFO 2015-08-24 00:00:27,345 [Ingest.binlightning-1]
Ingest: EDEX: Ingest - binlightning::
/data_store/binlightning/20150823/23/SFPA41_KWBC_232358_370

```

```
53073.nldn.2015082400 processed in: 0.0030 (sec) Latency:
0.0920 (sec)
```

```
Time spent in persist: 57
```

A typical log entry for ohd logs in edex-ingest-ohd-YYMMDD.log is

```
INFO 2014-10-24 00:08:34,113 [Ingest.dpa-1] DecodeDpaSrv:
Re-writing contents of file: KFCX_DPA_240001-
SDUS51_KRNK_570650261.rad.2014102400 to
/awips2/edex/data/share/hydroapps/precip_proc/local/data/dp
a_gather/KFCX_DPA_240001-
SDUS51_KRNK_570650261.rad.2014102400
```

This information is logged into the EDEX process logs for every file that is ingested. The general format of the message is *INFO <date> <time> [thread] Ingest: <type>:: <file> processed in: <time> Latency: <time>*. (Note that there are two spaces between INFO and the start of the date stamp.) This pattern can be used to monitor the EDEX Ingest process logs for ingest latency, using the pattern to filter out undesirable messages.

**NOTE:** Latency is the elapsed time between when the AWIPS II system first contacts a data file and when the data has been ingested, decoded, and is ready for retrieval by either CAVE or another client application. The “first contact” depends on the data type. For most data types, latency measurement starts when the product has been downloaded by the LDM Writer on the CP1f. This latency start time is part of the message generated by the LDM’s EDEX Bridge and sent to QPID (on the CP1/2 cluster) for processing by EDEX. For Radar products obtained from the ORPG via the AWIPS II Radar Server, latency measurement starts when the product is downloaded by the Radar Server on the DX1/2 cluster. In the case of ORPG products, the latency start time is part of the message sent by the Radar Server to QPID. Note that this latency measure is strictly internal for the AWIPS II data ingest subsystem.

#### 4.7 General Monitoring of the EDEX System

To monitor the EDEX logs for other specific events,

- Open a terminal session to the dx3 or dx4 EDEX server.
- Change directory to the edex log directory /awips2/edex/logs.
- Tail the current log file and pipe the output into grep with the appropriate search string. To determine the search string, first examine the appropriate EDEX log to find the event you want to monitor, and then determine the search pattern.

Here are some specific events captured from the EDEX log.

```
edex-ingest.log
LVR VA0001 2247S 16522E 232059 F360 MS470 271/075 TB0 S031
```

```

333 F360 VG000=
=====>toPointData
INFO 2014-03-24 00:00:30,589 [gfeDataURINotification-1]
      IFPServer: EDEX - Processing 11 grid DataURINotifications

WARN 2014-03-24 00:00:30,598 [gfeDataURINotification-1]
      D2DGridDatabase: EDEX - No gridParameterInfo found for
      refc_EA:OUN_GRID_D2D_RUC13_20140323_2300. Check parameterInfo
      file.

Time spent in persist: 35

INFO 2014-03-24 00:00:30,604 [Ingest.airep-1] Ingest: EDEX:
      Ingest - airep::
      /data_store/upperair/20140324/00/UDOC01_AMMC_240000_5731021.20
      14032400 processed in: 0.7260 (sec) Latency: 16.7900 (sec)

====240000 AMDAR

INFO 2014-03-24 05:26:00,079 [IoReceiver -
      cp1f/165.92.24.60:5672] ClientDelegate: Idle timeout is 0
      sec. Heartbeats are disabled.

ERROR 2014-03-24 05:26:00,094 [DefaultQuartzScheduler-
      rpgenvdata-camel_Worker-5] RPGEEnvironmentalDataManager:
      EDEX - Unknown radar ID 323

```

### 4.7.1 EDEX Log Event Levels

Note that each “event” in the above section starts with either FATAL, ERROR, WARN, INFO, or DEBUG and continues to the start of the next “event.”

- The ERROR level designates error events that might still allow the application to continue running.
- The FATAL level designates very severe error events that will presumably lead the application to abort.
- The INFO level designates informational messages that highlight the progress of the application at coarse-grained level.
- The WARN level designates potentially harmful situations.
- The DEBUG Level designates fine-grained informational events that are most useful to debug an application.

A “significant event” is anything a developer has decided should be logged. The AWIPS II system is built on top of a number of Open Source projects (Camel, Hibernate, etc.), which is referred to as *platform code*. Some of the logging is from the platform code. An example of logging generated by the platform code is a database error. Database errors are usually generated by the platform code. An example of a database error (somewhat truncated) is

```
ERROR 2014-08-30 17:15:29,952 [Ingest.pirep-1] IndexSrv:
```



```

Error occurred during persist

org.hibernate.exception.GenericJDBCException: Could not
execute JDBC batch update

    at
org.hibernate.exception.SQLStateConverter.handledNonSpecifi
cException(SQLStateConverter.java:140) ~[hibernate3.5.6-
Final.jar:3.5.6-Final]

    at
org.hibernate.exception.SQLStateConverter.convert(SQLStateC
onverter.java:128) ~[hibernate3.5.6-Final.jar:3.5.6-Final]

    at
org.hibernate.exception.JDBCExceptionHelper.convert(JDBCExc
eptionHelper.java:66) ~[hibernate3.5.6-Final.jar:3.5.6-
Final]

```

Other ERROR messages are generated by AWIPS II-specific code. An example of an error generated by AWIPS II code is

```

ERROR 2014-09-02 14:34:39,816 [Ingest.dpa-1] DecodeDpaSrv:
DPA Product not decoded. DpaDecoder process terminated with
exit code: 1

```

As a general rule, all “ERROR” messages and most “WARN” messages shown below are important. (Unfortunately, some messages logged as ERROR should be WARN.)

```

00:01:29,174 |-WARN in
c.q.l.core.rolling.helper.TimeBasedArchiveRemover -
Unexpected periodsElapsed value 0

WARN 2014-09-02 13:40:12,403 [qpfGenerate-1] QPFGenerator:
QPFConfig: No previous data for QPF. Check the RADAR OP
Mode.

```

INFO messages can also be important. The only person who can determine if a message is important is the person analyzing the log. For example, every file that is ingested is logged with an INFO message. The message will be similar to

```

INFO 2013-02-12 00:00:02,962 [Ingest.sfcobs -1] Ingest:
EDEX: Ingest - sfcobs::
/data_store/maritime/20130211/23/SXUS21_KWNB_112300_6169854
4.2013021200 processed in: 0.1960 (sec) Latency: 0.2050
(sec)

```

This message can become important in either of these scenarios:

- If a user is attempting to trace dataflow through the system, this message verifies that the file SXUS21\_KWNB\_112300\_61698544.2013021200 has been ingested.
- If a user is interested in system performance, the actual latency time reported becomes important.

In fact, what is not logged can also be “important.. The best example here is trying to trace data through the system. If the LDM reports that a file was written to the data archive but there is no corresponding “processed” log entry in the EDEX logs, this is significant/important information and it needs to be checked out.

#### 4.8 *Monitoring the LDM Data Flow*

The data flow from the LDM may be monitored using the *ldmadmin* tool. The *watch* option on this tool provides a running list of the LDM’s activity. This will show the data passing through the LDM. To use this tool, first log onto the LDM server (CPSBN) as the *ldm* user, and then enter:

##### **ldmadmin watch** (Type ^D when finished)

```

Jun 13 17:28:58 pqutil INFO:          9067 20160613172857.704 NEXRAD3
339091045  SDUS82 KMFL 131727 /pN0KAMX !nids/

Jun 13 17:28:58 pqutil INFO:          18950 20160613172857.705 NEXRAD3
339091046  SDUS84 KOUN 131726 /pN2HFDR !nids/

Jun 13 17:28:58 pqutil INFO:          6146 20160613172857.706 NEXRAD3
339091047  SDUS89 PAFG 131726 /pN2KAPD !nids/

Jun 13 17:28:58 pqutil INFO:          3840 20160613172857.706 NEXRAD3
339091048  SDUS29 PAFG 131725 /pN3UAEC !nids/

Jun 13 17:28:58 pqutil INFO:          24741 20160613172857.707 NEXRAD3
339091049  SDUS53 KMKX 131728 /pTR0MKE

Jun 13 17:28:58 pqutil INFO:          9019 20160613172857.708 NEXRAD3
339091050  SDUS39 PAFG 131725 /pN3SAEC

Jun 13 17:28:58 pqutil INFO:          95010 20160613172857.715 NEXRAD3
339091051  SDUS84 KLIX 131726 /pN1XLIX !nids/

Jun 13 17:28:58 pqutil INFO:          6755 20160613172857.716 NEXRAD3
339091052  SDUS89 PAFG 131726 /pHHCAPD !nids/

Jun 13 17:28:58 pqutil INFO:          6029 20160613172857.716 NEXRAD3
339091053  SDUS84 KLIX 131726 /pN1MLIX

Jun 13 17:28:58 pqutil INFO:          4148 20160613172857.717 NEXRAD3
339091054  SDUS84 KMOB 131726 /pDPREVX !nids/

```

Use the -f option and specify a FEED TYPE to see only products from that LDM feed. Examples follow.

##### **ldmadmin watch -f NNEXRAD** (Type ^D when finished)

```

Feb 13 14:45:30 pqutil INFO:          16586 20130213144529.997 NEXRAD3
65743231  SDUS52 KCHS 131444 /pN0QCLX !nids/

```

```

Feb 13 14:45:30 pqutil INFO:      165 20130213144529.997 NEXRAD3
65743232 SDUS33 KSGF 131439 /pNMDSGF !nids/

Feb 13 14:45:30 pqutil INFO:      2298 20130213144529.997 NEXRAD3
65743233 SDUS53 KLBK 131440 /pNTPLNX

Feb 13 14:45:30 pqutil INFO:      1296 20130213144530.011 NEXRAD3
65743234 SDUS53 KSGF 131439 /pNCRSGF

Feb 13 14:45:30 pqutil INFO:      11509 20130213144530.082 NEXRAD3
65743242 SDUS53 KABR 131444 /pN0RABR

Feb 13 14:45:30 pqutil INFO:      8287 20130213144530.099 NEXRAD3
65743243 SDUS73 KABR 131444 /pN0ZABR

```

**ldmadmin watch -f GRID**  
**(Type ^D when finished)**

```

Jan 06 15:51:34 pqutil INFO:      83790 20140106155134.021 NGRID
23276444 LVOF97 KWBC 061200
!grib2/nccep/GFS/#254/201401061200F030/VREL/0 K*m**2*kg-1*s-1 POTV

Jan 06 15:51:34 pqutil INFO:      78746 20140106155134.029 NGRID
23276445 LVOF97 KWBC 061200
!grib2/nccep/GFS/#254/201401061200F030/VREL/1 K*m**2*kg-1*s-1 POTV

Jan 06 15:51:34 pqutil INFO:      61034 20140106155134.037 NGRID
23276446 LVOF96 KWBC 061200
!grib2/nccep/GFS/#254/201401061200F030/VREL/0 - MWSL

Jan 06 15:51:34 pqutil INFO:      1264 20140106155134.037 NGRID
23276447 MHGL98 KWBT 061200
!grib2/nccep/GFS/#255/201401061200F027/HGHT/0 - NONE

Jan 06 15:51:34 pqutil INFO:      7227 20140106155134.037 NGRID
23276448 ELCM88 KWBJ 061200
!grib2/nccep/GMGWM/#255/201401061200F051/WVHGT/0 - NONE

Jan 06 15:51:34 pqutil INFO:      146981 20140106155134.052 NGRID
23276449 LPOF97 KWBC 061200
!grib2/nccep/GFS/#254/201401061200F030/PRES/0 K*m**2*kg-1*s-1 POTV

Jan 06 15:51:34 pqutil INFO:      78358 20140106155134.061 NGRID
23276450 LUOF97 KWBC 061200
!grib2/nccep/GFS/#254/201401061200F030/UREL/2 K*m**2*kg-1*s-1 POTV

Jan 06 15:51:35 pqutil INFO:      24587 20140106155134.258 NGRID
23276451 EYDM88 KWBJ 061200
!grib2/nccep/GMGWM/#255/201401061200F051/SWPER/1 - OSEQ

Jan 06 15:51:35 pqutil INFO:      76360 20140106155135.018 NGRID
23276452 LUOF97 KWBC 061200
!grib2/nccep/GFS/#254/201401061200F030/UREL/2 K*m**2*kg-1*s-1 POTV

Jan 06 15:51:35 pqutil INFO:      11815 20140106155135.019 NGRID
23276453 ERCM88 KWBJ 061200
!grib2/nccep/GMGWM/#255/201401061200F051/DRCT/0 - NONE

Jan 06 15:51:35 pqutil INFO:      39550 20140106155135.022 NGRID

```

```
23276454 LEOF98 KWBC 061200
!grib2/ncep/GFS/#254/201401061200F030/P06M/0 - NONE
```

**ldmadmin watch -f HDS**  
(Type ^D when finished)

```
Jun 13 17:29:48 pqutil INFO:      24188 20160613172947.624 HDS
339092834 IUCN21 RKSL 131645

Jun 13 17:29:48 pqutil INFO:      21248 20160613172947.626 HDS
339092835 IUCN47 RKSL 131645

Jun 13 17:29:48 pqutil INFO:      23812 20160613172947.628 HDS
339092836 IUCN42 RKSL 131645

Jun 13 17:29:48 pqutil INFO:      23812 20160613172947.630 HDS
339092839 IUCN05 RKSL 131645

Jun 13 17:29:48 pqutil INFO:      66710 20160613172947.636 HDS
339092844 ZETA98 KTUA 131729 /mNWS_152
!grib/nws/NWS_152/#255/201606130200/F001/O3TOT/sfc/
```

**ldmadmin watch -f NIMAGE**  
(Type ^D when finished)

```
Nov 06 13:28:03 pqutil INFO:      47600 20121106132802.869 NIMAGE
6851 satz/ch2/GOES-15/SOUND-11.03/20121106 1301/WEST-CONUS/10km/
TIGW48 KNES 061301

Nov 06 13:28:07 pqutil INFO:      33639 20121106132807.005 NIMAGE
6852 satz/ch2/GOES-15/SOUND-7.43/20121106 1301/WEST-CONUS/10km/
TIGW50 KNES 061301

Nov 06 13:28:09 pqutil INFO:      31610 20121106132809.217 NIMAGE
6853 satz/ch2/GOES-15/SOUND-7.02/20121106 1301/WEST-CONUS/10km/
TIGW51 KNES 061301

Nov 06 13:28:13 pqutil INFO:      23654 20121106132813.535 NIMAGE
6854 satz/ch2/GOES-15/SOUND-6.51/20121106 1301/WEST-CONUS/10km/
TIGW52 KNES 061301

Nov 06 13:28:15 pqutil INFO:      31514 20121106132814.754 NIMAGE
6855 satz/ch2/GOES-15/SOUND-4.45/20121106 1301/WEST-CONUS/10km/
TIGW55 KNES 061301
```

**ldmadmin watch -f IDS**  
(Type ^D when finished)

```
Jan 06 15:52:19 pqutil INFO:      315 20140106155219.378 IDS|DDPLUS
10998153 SXBO40 KWAL 061551

Jan 06 15:52:19 pqutil INFO:      76 20140106155219.378 IDS|DDPLUS
10998154 SRKS20 KWAL 061551

Jan 06 15:52:19 pqutil INFO:      177 20140106155219.379 IDS|DDPLUS
10998155 SRMN70 KWAL 061551
```

Jan 06 15:52:19 pqutil INFO: 10998156 SRWY20 KWAL 061551	96	20140106155219.379	IDS DDPLUS
Jan 06 15:52:19 pqutil INFO: 10998157 SRNJ20 KWAL 061551	143	20140106155219.380	IDS DDPLUS
Jan 06 15:52:19 pqutil INFO: 10998158 SRPA20 KWAL 061551	144	20140106155219.380	IDS DDPLUS
Jan 06 15:52:19 pqutil INFO: 10998159 SROK20 KWAL 061551	186	20140106155219.380	IDS DDPLUS
Jan 06 15:52:19 pqutil INFO: 10998160 SRPA30 KWAL 061551	144	20140106155219.381	IDS DDPLUS
Jan 06 15:52:19 pqutil INFO: 10998161 SRNY20 KWAL 061551	144	20140106155219.387	IDS DDPLUS
Jan 06 15:52:19 pqutil INFO: 10998162 SRAL75 KWAL 061551	224	20140106155219.387	IDS DDPLUS
Jan 06 15:52:19 pqutil INFO: 10998163 SRLA20 KWAL 061551	113	20140106155219.387	IDS DDPLUS
Jan 06 15:52:19 pqutil INFO: 10998164 SXCO50 KWAL 061551	129	20140106155219.388	IDS DDPLUS
Jan 06 15:52:19 pqutil INFO: 10998165 SROH30 KWAL 061551	160	20140106155219.388	IDS DDPLUS
Jan 06 15:52:19 pqutil INFO: 10998166 SXUT50 KWAL 061551	123	20140106155219.388	IDS DDPLUS
Jan 06 15:52:19 pqutil INFO: 10998167 SRWV30 KWAL 061551	130	20140106155219.389	IDS DDPLUS
Jan 06 15:52:19 pqutil INFO: 10998168 SXCA50 KWAL 061551	167	20140106155219.389	IDS DDPLUS
Jan 06 15:52:19 pqutil INFO: 10998169 SXCN40 KWAL 061551	436	20140106155219.389	IDS DDPLUS
Jan 06 15:52:19 pqutil INFO: 10998170 SRMO20 KWAL 061551	118	20140106155219.390	IDS DDPLUS
Jan 06 15:52:19 pqutil INFO: 10998171 SXID50 KWAL 061551	136	20140106155219.390	IDS DDPLUS
Jan 06 15:52:19 pqutil INFO: 10998172 SXXX03 KWAL 061551	155	20140106155219.390	IDS DDPLUS
Jan 06 15:52:19 pqutil INFO: 10998173 SRLA30 KWAL 061551	128	20140106155219.397	IDS DDPLUS
Jan 06 15:52:19 pqutil INFO: 10998174 SRSA40 KWAL 061551	134	20140106155219.397	IDS DDPLUS
Jan 06 15:52:19 pqutil INFO: 10998175 SRMD20 KWAL 061551	192	20140106155219.397	IDS DDPLUS
Jan 06 15:52:19 pqutil INFO: 10998176 SXCA50 KWAL 061551	144	20140106155219.398	IDS DDPLUS
Jan 06 15:52:19 pqutil INFO: 10998177 SRNJ20 KWAL 061551	143	20140106155219.398	IDS DDPLUS
Jan 06 15:52:19 pqutil INFO:	167	20140106155219.398	IDS DDPLUS

```

10998178  SXCH40 KWAL 061551
Jan 06 15:52:19 pqutil INFO:          191 20140106155219.399 IDS|DDPLUS
10998179  SRNY20 KWAL 061551
Jan 06 15:52:20 pqutil INFO:          163 20140106155220.366 IDS|DDPLUS
10998180  SXXM40 KWAL 061551

```

To see connections, open with ldm.

### netstat -ta | grep ldm

```

[ldm@cpsbn2-box ~]$ netstat -ta | grep ldm
tcp        0          0 cpsbn1-tbw3.er.:unidata-ldm *:*
LISTEN

```

To monitor the product queue v.

### pqmon

```

Aug 09 15:24:55 pqmon NOTE: Starting Up (15747)
Aug 09 15:24:55 pqmon NOTE: nprods nfree nempty      nbytes
      maxprods maxfree minempty  maxext age
Aug 09 15:24:55 pqmon NOTE: 75133      1 169006 999891712      81526
3    162613    109824 1652
Aug 09 15:24:55 pqmon NOTE: Exiting

```

[**Note:** The pqmon command is useful for looking at the state of the products queue, and whether or not the existing product queue size is sufficient for the amount of data coming in.]

To check for the running of the LDM

**ps -U ldm -u ldm u**

```

ldm      16631  0.0  0.0  24004  1200  ?           Ss   Jun09   0:02  ldmd  -I
165.92.24.50 -P 388 -M 256 -m 3600 -o 3600 -q /usr/lo
ldm      16633  1.5  3.0  1013216 990444 ?           S    Jun09   88:48  pgact -e
ldm      16634  0.1  0.1  224648  35032 ?           Sl   Jun09   10:38  edexBridge -
vxl /usr/local/ldm/logs/edexBridge.log -s cp1f
root     16635  3.4  3.2  1139568 1078336 ?           SLl  Jun09   200:20
noaaportIngester -b 10000 -m 224.0.1.1 -n -c -u 3 -t mhs -r 1
root     16636  0.3  3.2  1162776 1081164 ?           SLl  Jun09   19:13
noaaportIngester -b 10000 -m 224.0.1.2 -n -c -f -u 4 -t mhs -
root     16637  5.9  4.0  1381788 1320184 ?           SLl  Jun09   345:21
noaaportIngester -b 10000 -m 224.0.1.3 -n -c -u 5 -t mhs -r 1
root     16638  0.1  3.2  1142084 1064312 ?           SLl  Jun09    8:15
noaaportIngester -b 10000 -m 224.0.1.4 -n -c -u 6 -t mhs -r 1
root     16639  0.3  3.2  1154968 1073320 ?           SLl  Jun09   19:48
noaaportIngester -b 10000 -m 224.0.1.5 -n -c -u 7 -t mhs -r 1
root     16640  0.0  3.2  1136840 1058840 ?           SLl  Jun09    0:01
noaaportIngester -b 10000 -m 224.0.1.6 -n -c -u 4 -t mhs -r 1
root     16641  0.0  3.2  1136840 1058840 ?           SLl  Jun09    0:01
noaaportIngester -b 10000 -m 224.0.1.7 -n -c -u 7 -t mhs -r 1
root     16642  0.0  3.2  1136840 1058840 ?           SLl  Jun09    0:01
noaaportIngester -b 10000 -m 224.0.1.8 -n -c -u 7 -t mhs -r 1
root     16643  0.0  3.2  1136840 1055012 ?           SLl  Jun09    0:01
noaaportIngester -b 10000 -m 224.0.1.9 -n -c -u 4 -t mhs -r 1
root     16644  0.0  3.2  1136840 1055012 ?           SLl  Jun09    0:01
noaaportIngester -b 10000 -m 224.0.1.10 -n -c -u 4 -t mhs -r

```

**NOTE:** At each AWIPS site, there are two CPSBNs responsible for receiving GOES products and a combination of NCEP products from the NCF. No site has more than two CPSBNs unless it has an NRS.

Although each of the two CPSBNs (CPSBN1 and CPSBN2) receive the entire stream of data, for AWIPS II only one CP is configured to forward the entire data to AWIPS data acquisition server. The data are split by channels, and at any point in time only one CPSBN forwards channel data so duplicate data are not being ingested. Because each CPSBN can process the entire data stream, they back each other up. When one CPSBN is actively processing all 4 channels, the other CPSBN will be the hot spare. To check channels received, examine the ldmd.conf file to look at running ldm processes.

[**Note:** The CP ingest is tied to the cp1f package. The hb\_stat output will show the following.]

Heartbeat Status Monitor

Jul 17 15:36:08

===== Member Status =====

Member	Status	IP address
cpsbn1-oax	Up	165.92.109.50
cpsbn2-oax	Up	165.92.109.51

===== Service Status =====

Service	IPaddr	Cronfile	Owner	Start Time
---------	--------	----------	-------	------------

```
-----
a2cp1apps 165.92.109.60 a2cp1cron,a2SIT cpsbn1-oax 2013-06-06 14:12:42
a2cp2apps 165.92.109.62 a2cp2cron,a2SIT none down
```

```
[root@cpsbn1-tbw3]# ps -wef|grep noaaport
```

```
root      16635 16631  3 Jun09 ?          03:20:21 noaaportIngester -b
10000 -m 224.0.1.1 -n -c -u 3 -t mhs -r 1 -s NMC
root      16636 16631  0 Jun09 ?          00:19:13 noaaportIngester -b
10000 -m 224.0.1.2 -n -c -f -u 4 -t mhs -r 1 -s GOES
root      16637 16631  5 Jun09 ?          05:45:22 noaaportIngester -b
10000 -m 224.0.1.3 -n -c -u 5 -t mhs -r 1 -s NMC2
root      16638 16631  0 Jun09 ?          00:08:15 noaaportIngester -b
10000 -m 224.0.1.4 -n -c -u 6 -t mhs -r 1 -s NOAAPORT_OPT
root      16639 16631  0 Jun09 ?          00:19:48 noaaportIngester -b
10000 -m 224.0.1.5 -n -c -u 7 -t mhs -r 1 -s NMC3
root      16640 16631  0 Jun09 ?          00:00:01 noaaportIngester -b
10000 -m 224.0.1.6 -n -c -u 4 -t mhs -r 1 -s ADD
root      16641 16631  0 Jun09 ?          00:00:01 noaaportIngester -b
10000 -m 224.0.1.7 -n -c -u 7 -t mhs -r 1 -s ENC
root      16642 16631  0 Jun09 ?          00:00:01 noaaportIngester -b
10000 -m 224.0.1.8 -n -c -u 7 -t mhs -r 1 -s EXP
root      16643 16631  0 Jun09 ?          00:00:01 noaaportIngester -b
10000 -m 224.0.1.9 -n -c -u 4 -t mhs -r 1 -s GRW
root      16644 16631  0 Jun09 ?          00:00:01 noaaportIngester -b
10000 -m 224.0.1.10 -n -c -u 4 -t mhs -r 1 -s GRE
```

**Note:** Sites normally see only the first 5 channels listed above. The ADD channel only exists at sites where Data Delivery is activated. As of now, that is limited to test beds and a few regions. Once Data Delivery is “activated and operational”, then all the sites will be able to see the 6th channel (ADD).

[**Note:** These numbers in bold in the example above correspond to the different channels of SBN downlink. There is one dvbs\_multicast process that listens to each multicast address and processes that particular channel.]

```
[root@cpsbn1-tbdw]# ps -fu ldm
```

```
UID          PID  PPID  C  STIME TTY          TIME CMD
ldm          11734    1  0  2013 ?          00:00:00 ldmd -I 165.92.29.180 -
P 388 -M 256 -m 3600 -o 3600 -q /usr/
ldm          11736 11734  0  2013 ?          01:53:23 pqact -e
ldm          11737 11734  0  2013 ?          00:09:08 edexBridge -vxl
/usr/local/ldm/logs/edexBridge.log -s cplf
ldm          20590 20589  0  15:48 pts/0      00:00:00 -bash
ldm          21519 20590  0  15:55 pts/0      00:00:00 ps -fu ldm
```



## 4.9 Product Identifier

The LDM writer uses patterns in `pqact.conf` to determine where to write data files, including the path and file name.

`config_awips2.sh` creates an entry for radar data that is combined along with the `pqact` template and other generated entries into the active `pqact.conf` file.

For example, use the following reference to help decipher a `pqact.conf` entry, that matches an LDM product with these fields:

```

NNEXRAD ^(.SDUS[234578].|NXUS6.)
(K|P|T)(OUN|AMA|FWD|DDC|SJT|GLD|GID|LZK|LUB|EWX|SHV|SGF|TOP|TSA|ICT)
(..)(..)(..) /p(..)(..)
      FILE      -overwrite -log -close -edex
/data_store/radar/(\4:yyyy)(\4:mm)\4/\5/\2\8/\7/\2\8_\7_\4\5\6-
\1_\2\3_(seq).rad.%Y%m%d%H

```

**The first part, NNEXRAD,** is the FEEDTYPE.

The Regular Expression describes any product starting with `SDUS` and follows with any numbers 2,3,4,5,7 or 8 OR starting with `NXUS6`.

The `()` stores that string in the variable `\1`, which can be used when storing to physical disk.

`(K|P|T)` matches either a K, a P, or a T, and stores it in the variable `\2`.

`(OUN|AMA|FWD|DDC|SJT|GLD|GID|LZK|LUB|EWX|SHV|SGF|TOP|TSA)` matches any of those site IDs and stores it in variable `\3`.

`(..)(..)(..)` matches the next 6 characters of any type and stores them in pairs in variables `\4`, `\5` and `\6` respectively.

`/p` matches the exact string `/p`

`(..)(..)` matches the next 6 characters of any type and stores them in trios in variables `\7` and `\8`.

The following line matches this entry in `pqact` to the following storage location:

### Product:

```
NEXRAD3 56424268 SDUS51 KLWX 211529 /pTZLDCA !nids/
```

### Storage Location:

```
/data_store/radar/20140512/17/KDCA/TZL/1529_KDCA_TZL_56424268.rad
```

**For DPA products,** the pattern is nearly identical:

In this case, only DPA products are matched, so the `NNN` entry is hard coded as `DPA`.

### Product:

```
NEXRAD3 56424268 SDUS51 KLWX 211529 /pDPADCA !nids/
```

### Storage Location:

```
/data_store/radar/KDCA/TZL/1529_KDCA_DPA_56424268.rad
```

The number before the ".rad" is the sequence number (**56424268** in this case) that is set at the Gateway when transmitted over the SBN and can be traced to the ldm logs on the active cpsbn.

[**Note:** Sequence numbers are NOT reset at all. The only exception occurs when the data channels are moved from one DSUP to another. Also, it will be different when the operations are moved from ANCF to BNCF servers.]

To determine which cpsbn is active, perform the following steps and look for running ldm processes.

### CPSBN1 Example:

```
[root@cpsbn1-tbdw ~]# ps -ef | grep ldm
```

```
ldm      11734      1  0  2013 ?          00:00:00 ldmd -I 165.92.29.180 -
P 388 -M 256 -m 3600 -o 3600 -q /usr/local/ldm/data/ldm.pq
/usr/local/ldm/etc/ldmd.conf
ldm      11736 11734  0  2013 ?          01:53:26 pqact -e
ldm      11737 11734  0  2013 ?          00:09:08 edexBridge -vxl
/usr/local/ldm/logs/edexBridge.log -s cplf
root     22616 20316  0 16:00 pts/0      00:00:00 grep ldm
```

### CPSBN2 Example:

```
[root@cpsbn2-tbdw ~]# ps -ef | grep ldm
```

```
root     21927 21847  0 13:12 pts/0      00:00:00 grep ldm
```

So in this case, CPSBN1 is active and look for the sequence number 56424268 (as above) in the ldm logs.

## 4.10 Qpid

In the qpid commands that follow, you are looking for queues in which the msg column has a large number. This means that messages are coming in, but nothing is taking them out.

You could also look at the msgIn and msgOut columns to get the same type of picture on the health of the system. The NCF has set up monitors based on this data in order to keep track of the health of the system, and restart things if necessary.

```
[root@cpsbn1-oax ~]# ps -ef | grep qpid
```

```
root     22948 20316  0 16:02 pts/0      00:00:00 grep qpid
root     32392      1  0  2013 ?          00:00:00 su awips -c /bin/bash
/awips2/qpid/bin/qpid-wrapper
```

```

awips  32394 32392  0 2013 ?          00:00:00 /bin/bash
/awips2/qp/qp/bin/qp-wrapper
awips  32397 32394  0 2013 ?          00:00:08 /awips2/java/bin/java -
Xmx32m -XX:MaxPermSize=12m -XX:ReservedCodeCacheSize=4m -jar
/awips2/qp/bin/yajsw/wrapper.jar -c /awips2/qp/conf/wrapper.conf
awips  32424 32397  9 2013 ?          1-09:08:41 /awips2/java/bin/java
-classpath
/awips2/qp/bin/yajsw/./wrapperApp.jar:/awips2/qp/bin/yajsw/wrapper.
jar:/awips2/qp/lib/opt/*:/awips2/qp/lib/opt/qp-deps/* -
XX:+UseConcMarkSweepGC -XX:+CMSIncrementalMode -XX:NewSize=400m -
XX:MaxNewSize=400m -XX:SurvivorRatio=4 -XX:+HeapDumpOnOutOfMemoryError
-XX:HeapDumpPath=/data/fga/qp -server -DPNAME=QPBRKR -
Damqj.logging.level=info -DQPID_HOME=/awips2/qp -
DQPID_WORK=/awips2/qp -Damqj.read_write_pool_size=32 -
Dqpqid.broker.exceptionHandler.continue=true -Xmx2048m -
Dwrapper.port=15003 -Dwrapper.key=-7261080382435685649 -
Dwrapper.tmp.path=/tmp -Djna_tmpdir=/tmp -
Dwrapper.config=/awips2/qp/conf/wrapper.conf
org.rzo.yajsw.app.WrapperJVMMain

```

### [root@cpsbn1-oax ~]# qp-queue-count -Smsg -L10

```

Queues
queue
=====
Ingest.Grib 31 3.19k 8
metaDataPurgeWork 1 0 1
_pluginPurged@amq.topic_b98ca05d-fd4c-4259-b2d1-f4b9ef5e4c0e 0 0 1
Ingest.lsr 0 0 2
edex.alerts.utility@amq.topic_6576915d-b5b9-4bc8-
97f-322a0b575b11 0 0 1
Ingest.bufrssmi 0 0 2
Ingest.nucaps 0 0 2
Ingest.regionalsat 0 0 2
mpeLightSrvScheduledWork 0 0 2
_edex.alerts.utility@amq.topic_31ccc933-82d0-420c-afeb-
7186001e7082 0 0 1

```

### [root@cpsbn1-oax ~]# qp-stat -q -S msg -L10

```

Queues
queue
=====
msgIn msgOut bytes bytesIn bytesOut cons bind
=====
_edex.alerts.gfe@amq.topic_1f0d6518-7564-469e-b192-a5bd3e7f78d1 Y 0 30.6k
30.6k 0 111m 111m 1 2
Ingest.ssha Y 0
0 0 0 0 0 2 2
Ingest.ldadprofiler Y 0
0 0 0 0 0 2 2
_purgeGridInfoCache@amq.topic_b09f7f29-fc1e-4da2-9254-7c09fe463e1f Y 0
3 3 0 440 440 1 2
Ingest.Mesowest Y 0
0 0 0 0 0 2 2
Ingest.acars Y 0
39.1k 39.1k 0 3.19m 3.19m 2 2

```

```

handleoup.dropbox                                Y                                0
391 391 0 19.8k 19.8k 2 2
_edex.alerts@amq.topic_4c2c0a0b-013e-4d4e-82e2-4fe5239f9227 Y 0 8.28k
8.28k 0 94.1m 94.1m 1 2
mpeLightSrvScheduledWork                        0
328 328 0 0 0 2 2
_pluginPurged@amq.topic_2d930cd2-4a37-4d67-95b1-504f47d352db Y 0 2.41k
2.41k 0 16.0k 16.0k 1 2

Y 0 383 383 0 19.4k 19.4k 2 2

```

### [root@cpsbn1-oax ~]# qpuid-stat -q -S msg -L3

```

Queues
queue                                           dur  excl  msg
msgIn msgOut bytes bytesIn bytesOut cons bind
=====
_edex.alerts.gfe@amq.topic_1f0d6518-7564-469e-b192-a5bd3e7f78d1 Y 0 30.8k
30.8k 0 111m 111m 1 2
Ingest.ssha                                    Y 0 0
0 0 0 0 2 2
Ingest.ldadprofiler                            Y 0 0
0 0 0 0 2 2

```

## 4.11 LDM Ingest Checklist

In order to add a line to the `pqact.conf` or `pqact.local` file for LDM ingest, certain information is necessary. The following is a general checklist of information that can be used when adding new data from the SBN into the system.

- Note the WMO header or pattern for desired product: \_\_\_\_\_
- Note the LDM FEEDTYPE for the desired product: \_\_\_\_\_
- Note the raw archive location for the desired product: \_\_\_\_\_
- Create entry in the `pqact.conf` or `pqact.local` file: \_\_\_\_\_
- Restart or send HUP to `ldmd` process.

The following steps may be useful in finding the above information.

### 1. Find the WMO header or pattern for the desired product.

If the product is being ingested into an AWIPS I system, look at the `/data/fxa/customFiles/acqPatternAddOns.txt` file. It is possible that you will discover the WMO pattern needed for ingesting. A listing of WMO header bulletins can also be found starting at the following URL: <http://www.nws.noaa.gov/tg/table.html>

### 2. Find the LDM FEEDTYPE for the desired product.

In all cases, the FEEDTYPE “ALL” will match all the FEEDTYPES listed. However, tools are available that may help identify the proper FEEDTYPE, if that is of interest. As user `ldm` the following commands might be useful:

```
# ldmadmin watch
```

This command will show all data coming from the LDM server. This should be every product that the ldm is ingesting. Watching can identify specific feedtypes of the products being ingested. A sample output of the command follows.

```
# notifyme -l- -h $LDM_HOST -v -p '<WMO ID Pattern>'
```

This command will print to the screen every product available from <LDM IP/Hostname> that matches <WMO ID Pattern>. For example, the following would print all products starting T available from CPSBN1:

```
notifyme -l- -h cpsbn1 -v -p '^T.*'
```

**Note:** The pattern passed to notifyme, and put into the pqact.conf file, must be a valid regular expression.

A sample output of the command follows.

```
-bash-3.2$ notifyme -l- -v -h adam1 -p '^sat.*TI.*'
Jan 21 15:17:37 notifyme[6887] NOTE: Starting Up: adam1:
20110121151737.886 TS_ENDT {{ANY,  "^sat.*TI.*"}}
Jan 21 15:17:37 notifyme[6887] NOTE: LDM-5 desired product-class:
20110121151737.886 TS_ENDT {{ANY,  "^sat.*TI.*"}}
Jan 21 15:17:37 notifyme[6887] INFO: Resolving adam1 to 165.92.24.36
took 0.000398 seconds
Jan 21 15:17:37 notifyme[6887] NOTE: NOTIFYME(adam1): OK
Jan 21 15:19:33 notifyme[6887] INFO:      26096 20110121151933.179
NIMAGE 47222  satz/ch1/GOES-13/SOUND-14.06/20110121 1446/EAST-
CONUS/10km/ TIGE43 KNES 211446
Jan 21 15:19:34 notifyme[6887] INFO:      72646 20110121151934.390
NIMAGE 47223  satz/ch1/GOES-13/SOUND-11.03/20110121 1446/EAST-
CONUS/10km/ TIGE48 KNES 211446
Jan 21 15:19:38 notifyme[6887] INFO:      58914 20110121151938.479
NIMAGE 47224  satz/ch1/GOES-13/SOUND-7.43/20110121 1446/EAST-
CONUS/10km/ TIGE50 KNES 211446
Jan 21 15:19:40 notifyme[6887] INFO:      51259 20110121151940.513
NIMAGE 47225  satz/ch1/GOES-13/SOUND-7.02/20110121 1446/EAST-
CONUS/10km/ TIGE51 KNES 211446
Jan 21 15:19:44 notifyme[6887] INFO:      45947 20110121151944.599
NIMAGE 47226  satz/ch1/GOES-13/SOUND-6.51/20110121 1446/EAST-
CONUS/10km/ TIGE52 KNES 211446
```

Both of these commands will give other information that can be used in writing the data to disk in the raw archive in a more useful format.

### 3. Note the raw archive location for the product.

In general, the raw archive used is /data\_store/<product type>. For example, radar products are put into a subtree of /data\_store/radar based on the information. It is good practice to continue to follow this paradigm. However, as long as the -edex argument is used in the pqact.conf entry, the product should be decoded no matter where the physical storage location ends up as long as the EDEX server has access to that location.

### 4. Create the pqact.conf entry.

Create an entry in the `pqact.conf` file.

**5. Restart or send HUP signal to LDM server.**

Restart or send a HUP signal to the LDM server.

## **Chapter 5**

### **Ingest of Satellite Imagery**

## Chapter 5. Ingest of Satellite Imagery

### Table of Contents

	<i>Page</i>
5.1 Overview .....	1
5.2 Satellite Ingest Data Flow .....	2
5.2.1 Data Archive and File Naming Conventions for Satellite Data.....	5
5.2.1.1 LDM Configuration .....	7
5.2.2 Decoding – Satellite Data .....	7
5.2.3 Data Ingest and Logging of Satellite Products.....	7
5.3 Monitoring the LDM Data Flow and GOES data .....	9
5.3.1 Verifying LDM Operation on the CP cluster.....	10
5.3.2 Monitoring LDM Data Flow on the CP or DX Cluster .....	11
5.4 GOES Troubleshooting and Tips.....	16
5.4.1 Troubleshooting .....	16
5.5 Data Archive Directory .....	16
5.6 Data Archive Directory .....	19

### List of Exhibits

Exhibit 5.2-1. Satellite Ingest Data Flow .....	3
Exhibit 5.2.1-1. Acquire and Ingest of Satellite Products.....	6

### List of Tables

Table 5.3.2-1. Selected LDM Feed Types .....	14
--	----



## 5.1 Overview

All GOES imagery products received by AWIPS sites are distributed frame by frame over two of the ten NOAAPORT/SBN Channels. The ten channels are:

**Note:** Sites normally see only the first 5 channels listed below. ADD channel will only exist at sites where Data Delivery is activated. As of now, that is limited to test beds and a few regions. Once Data Delivery is “activated and operational”, then all the sites would be able to see the 6th channel (ADD).

1. **GOES.** The GOES Channel contains information from the GOES East satellite and the GOES West satellite. The GOES East satellite is a data stream consisting of these imagery products: visible infrared and water vapor for the Eastern Conterminous United States (CONUS), Puerto Rico, supernational composites, and Northern Hemisphere (NH) composites. The GOES West satellite is a data stream consisting of the following imagery products: visible infrared and water vapor for CONUS, Alaska, and Hawaii; supernational composites, and NH composites. AWIPS II also incorporates the capability to ingest and display National Polar Program (NPP) satellite imagery. NPP polar orbiter imagery is critical for WFOs located at high latitudes, such as those in Alaska. In this release Himawari products are provided by the Japanese Meteorological Agency’s Himawari 8 satellite. The main instrument aboard satellite is the Advanced Himawari Imager (AHI). This is a 16-channel multispectral imager that captures visible light and infrared images of the Asia-Pacific region. The instrument has similar spectral and spatial characteristics to the Advanced Baseline Imager (ABI) used by the GOES-R satellites. This data is centered over Japan and covers most of the Pacific Region. As a result, this data will be of value primarily for WFOs within the Pacific Region. Most CONUS sites will not find the data useful.
2. **NMC.** From the NWS Telecommunications Gateway (NWSTG), a data stream consisting of model output from the National Centers for Environmental Prediction (NCEP); the observations, forecasts, watches, and warnings produced by NWS Forecast Offices; WSR-88D radar products; and most observational data over North America.
3. **NMC2.** The NWSTG2 channel supplements the NWSTG channel. It contains all Model Grid data.
4. **NOAAPORT\_OPT Channel.** This channel's data stream includes GOES DCP data, GMS/GOES-West/GOES-East/METEOSAT-5//METEOSAT-7 composites for visible infrared and water vapor products (every 3 hours), and OCONUS grids.
5. **NMC3.** This channel's data stream includes Polar Satellite data (NPP).
6. **ADD.** This channel contains AWIPS Data Delivery products for subscriptions shared by more than one AWIPS site.

7. **ENC.** This channel is for data that is required to be encrypted before ingesting over the SBN.
8. **EXP.** Experimental Data.
9. **GRW:** This channel is for GOES-R West products.
10. **GRE.** This channel is for GOES-R East products.

## 5.2 *Satellite Ingest Data Flow*

The Satellite Ingest data flow, illustrated in Exhibit 5.2-1, is a 12-step process. Descriptions of each step follow.

1. Satellite data is obtained by the LDM noaaportIngester from the SBN.
  - a. The LDM noaaportIngester forwards the product to the LDM Writer instance.
  - b. The LDM Writer instance writes the product to the Data Archive. [Data Archive (/data\_store) directory is mounted on the hosts off the NAS [NAS2].]
  - c. The LDM writer instance uses the EDEX Bridge to post a message containing product information to the QPID Message Broker. The product information is the WMO header and the path to the product file.

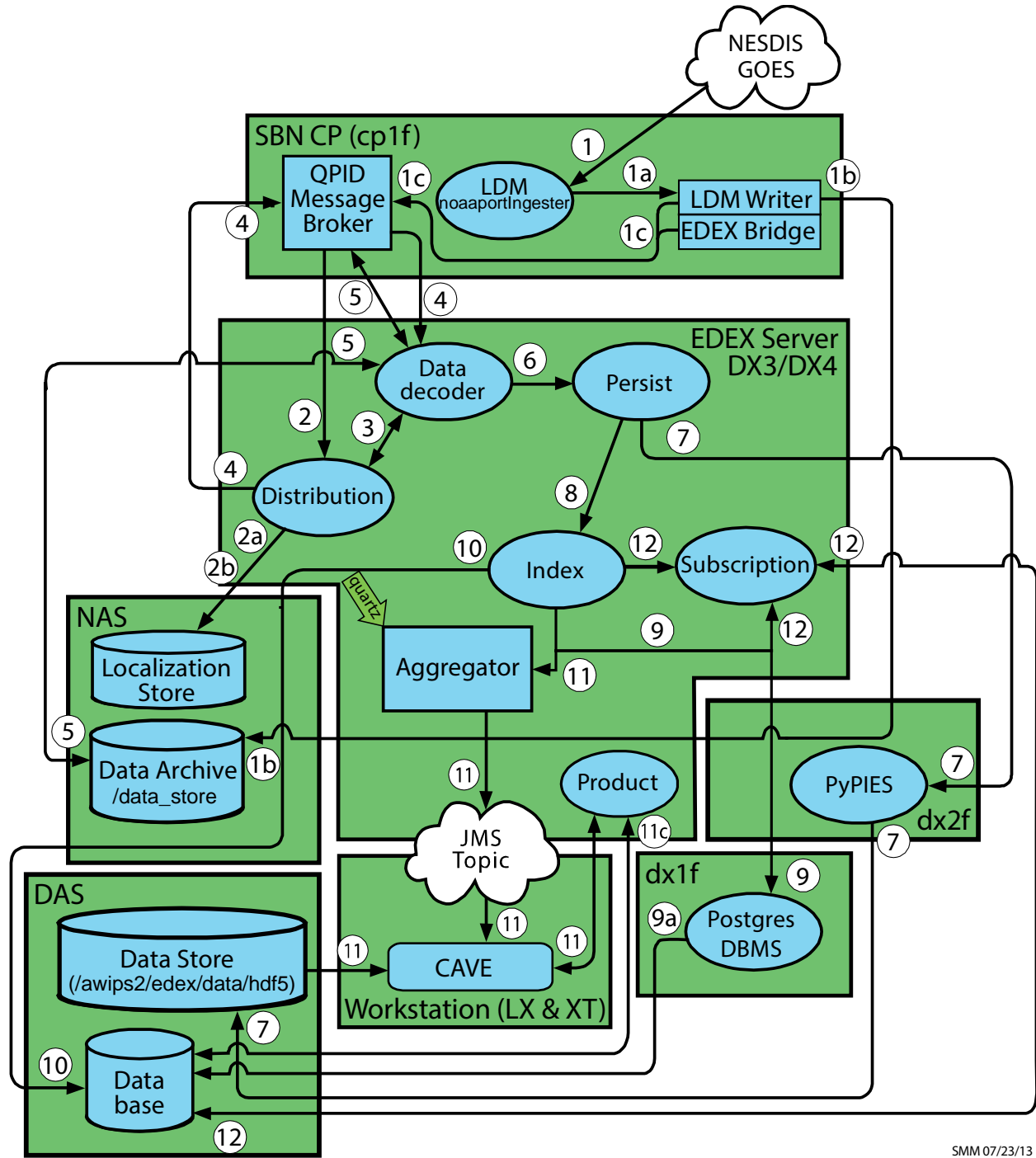

Exhibit 5.2-1. Satellite Ingest Data Flow

2. The EDEX Distribution endpoint on the EDEX (DX) cluster pulls the message from the QPID Message Broker. The WMO header is matched against data distribution mappings contained in the data distribution directory to determine product routing. (The WMO header is included in the message; if it is not, the Distribution service uses the product file name from the message to determine routing.) **Note:** The files in

- the data distribution directory are XML files that contain regular expressions that match WMO headers with the appropriate data decoder plug-in.
- a. At EDEX startup, the EDEX Distribution endpoint reads the Data Distribution files from the Data Distribution directory in the Localization Store. It uses the contents of these files to generate the routing table used to determine data routing. The Data Distribution directory is located at `/awips2/edex/data/utility/edex_static/base/distribution`.
  - b. The EDEX Distribution endpoint monitors the Data Distribution directory; when a file in that directory is modified, it re-reads that file and rebuilds its routing table.
3. The EDEX Distribution Service determines the Data Decoder Plug-In registered to handle the data in the product file.
  4. The EDEX Distribution Service forwards the message to the appropriate Data Decoder Plug-In via the QPID Message Broker.
  5. The EDEX Data Decoder Service on the EDEX (DX) cluster pulls the message from the QPID Message broker. The Data Decoder Service reads the file pointed to by the message, decodes the data, and determines the appropriate metadata.
  6. The decoded data and metadata are sent to the EDEX Persist endpoint.
  7. The EDEX Persist endpoint sends the data to PyPIES, and PyPIES writes the data to the EDEX data store in HDF5 format.
  8. The EDEX Persist endpoint sends the metadata obtained to the EDEX Index endpoint.
  9. The EDEX Index endpoint sends the metadata to the PostgreSQL DBMS.
    - a. The PostgreSQL DBMS writes the metadata to the database.
  10. The index endpoint persists the data object to the database. It does not just get the dataURI. Persistence to the database is executed via a plugin defined data access object. If the data access object does not override the persistence behavior, then a default persistence strategy is used. The default strategy for persisting data to the database is to first check to see if the data received already exists. If it already exists, then persistence to the database is not attempted for that data. If the data is unique, then it is persisted to the database.
  11. (Client notification) The Data URI is forwarded to the EDEX URI Aggregator.
    - a. Every 5 seconds the aggregated Data URIs are sent to the JMS Alert Topic.
    - b. CAVE monitors the JMS Alert Topic to obtain a list of available data. CAVE determines if it should render the available data.
    - c. CAVE retrieves metadata from the EDEX server via a product query sent to the EDEX thrift endpoint.

- d. CAVE retrieves product data from the EDEX server by accessing the EDEX data store's HDF5 files and CAVE renders the data, updating its display as appropriate.
12. (Subscription) The Data URI is forwarded to the EDEX Subscription endpoint. (Note: This does not apply to Satellite Data)
- a. The EDEX Subscription endpoint checks the active subscription list to determine if a subscription has been registered for the product.
    - 1) If no subscription has been registered for the product, no further action is taken.
  - b. The EDEX Subscription endpoint obtains the script information from the database.
  - c. The EDEX Subscription endpoint obtains a micro-engine to execute the script.
    - 1) The micro-engine executes the subscription script for the product.

### 5.2.1 Data Archive and File Naming Conventions for Satellite Data

As illustrated in Exhibit 5.2.1-1, the satellite data received over the SBN are stored in the following directory structure.

**/data\_store/sat/<YYYYMMDD>/<HH>/<SECTOR ID>/<PHYSICAL ELEMENT>/**

The **<SECTOR ID>** is the satellite the image was derived from. GOES\_WEST and GOES\_EAST are not always GOES-15 and GOES-14 respectively. This depends on how NESDIS moves the satellites in and out of storage orbits. This is important because GOES-15 and GOES-14 have blackout periods during which they do not send products. For example, east CONUS is predominately covered by GOES-14, but for a short period in the early morning, its source of data is GOES-15. In the case of supernational products, GOES-15 is the source for the top and bottom of the hour, and GOES-14 is the source at 15 and 45 minutes past the hour.

**Note:** AWIPS II is still receiving products from NESDIS with the GOES-11 and GOES-12 identifiers. This is intentional, and is done in order to maintain compatibility with the AWIPS decoder.

- The **<PHYSICAL ELEMENT>** indicates if it is an element in the visible infrared, water vapor, etc. ranges.

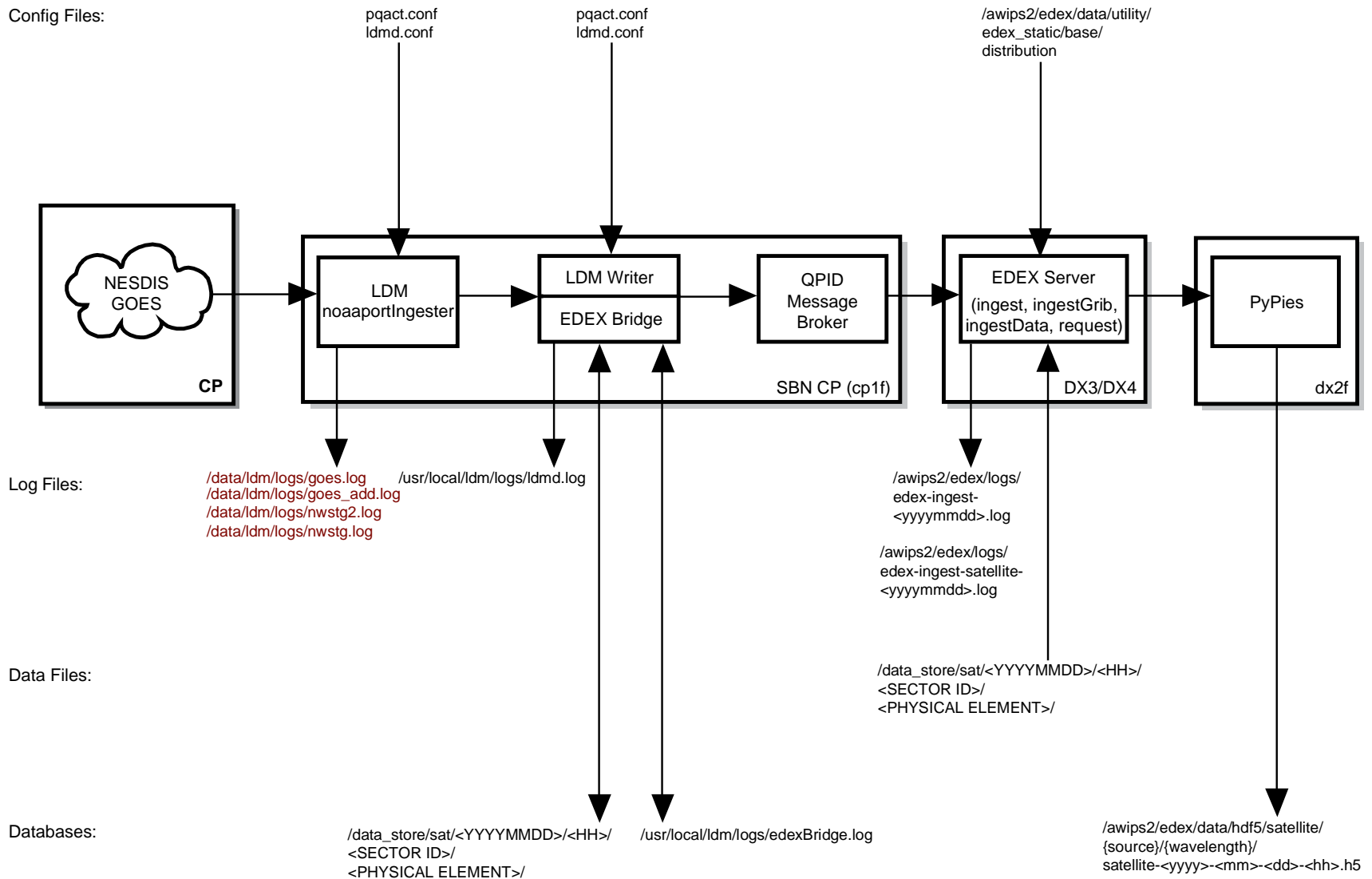

**Exhibit 5.2.1-1. Acquire and Ingest of Satellite Products**

### 5.2.1.1 LDM Configuration

LDM server runs only on the SBN CP. It ingests everything from the SBN.

LDM behavior is controlled by the `pqact.conf` file, and the patterns are matched against **pqact.conf**. LDM writes the product to `data_store` and posts a QPID message.

- **pqact.conf** controls how data sent to an instance of LDM is handled. This includes the data types to be handled and the location of the raw data archive.

**NOTE:** Modifying `pqact.conf` will have a severe impact on the data flow.

### 5.2.2 Decoding – Satellite Data

Data decoding operations are performed on the EDEX (DX3/4) servers. Both EDEX servers share the load in the ingest process, which includes decoding the raw data, writing the decoded data into the Data Store, writing metadata to the database, and broadcasting a notification that the newly ingested data is available.

The raw satellite files are stored in the Data Archive (`:/data_store`). The physical directory is on the NAS2. All the hosts, including the CPSBN, mount the volume off NAS2.

The processed data is stored in `/awips2/edex/data/hdf5` in the hdf5 format on the dx2f server. The current satellite data in the HDF5 store is organized according to the pattern `/awips2/edex/data/hdf5/satellite/satellite/satellite-YYYY-MM-DD- $\langle$ HH $\rangle$ .h5`, `/awips2/edex/data/hdf5/satellite/Supernational/Imager Visible/satellite-2013-02-13-15.h5`

### 5.2.3 Data Ingest and Logging of Satellite Products

All satellite data ingest operations are logged in the EDEX logs on the EDEX (DX3/4) server. In a standard installation, the EDEX logs are located in `/awips2/edex/logs`.

The `edex-ingest-satellite` log file handles the satellite products.

The EDEX logs roll over daily and are date stamped.

For the satellite decoder, the instance name is “`ingest`,” so the satellite ingest log for Feb. 13, 2013, is named **`edex-ingest-satellite-20130213.log`**.

**NOTE:** Each EDEX Server (DX3 and DX4) has its own set of separate log files. Both sets of log files have the same names and structure, but they contain different information.

The log file is a plain ASCII text file and can be viewed using any text-viewing utility such as *more*, *less*, *view*, or *tail*.

To get a general view of processing, open a terminal session to the server and enter the following commands:

**On DX3/DX4,**

**TYPE:** `cd /awips2/edex/logs`

**TYPE:** `date +%F`

**2013-02-13**

**TYPE:** `ls edex*20130213*`

```
edex-ingest-20130213.log
edex-ingestDat-20130213.log
edex-ingest-gen_areal_ffg-20130213.log
edex-ingest-gen_areal_qpe-20130213.log
edex-ingestGrib-20130213.log
edex-ingest-purge-20130213.log
edex-ingest-radar-20130213.log
edex-ingest-satellite-20130213.log
edex-ingest-shef-20130213.log
edex-ingest-shef-performance-20130213.log
edex-ingest-smartInit-20130213.log
edex-ingest-text-20130213.log
edex-ingest-unrecognized-files-20130213.log
edex-request-20130213.log
edex-request-productSrvRequest-20130213.log
edex-request-thriftSrv-20130213.log
edex-ingest-archive-20130213.log
edex-ingest-GFEPPerformance-20130213.log
edex-request-GFEPPerformance-20130213.log
edex-ingestDat-performance-20130212.log
edex-ingest-activeTableChange-20130213.log
edex-ingestDat-activeTableChange-20130213.log
edex-ingestDat-performance-20130213.log
edex-ingestGrib-activeTableChange-20130213.log
edex-ingestGrib-performance-20130213.log
edex-ingest-performance-20130213.log
edex-request-activeTableChange-20130213.log
edex-request-performance-20130213.log
edex-ingest-gen_areal_qpe-20130213.log
edex-ingest-ohd-20130213.log
edex-request-textdbSrvRequest-20130213.log
edex-request-hibernate-20130213.log
edex-ingest-hibernate-20130213.log
```



```
edex-ingest-sportlma-20130213.log
edex-ingestGrib-hibernate-20130213.log
ERconfig.log
```

**Note:** edex-ingestDat log file is only available on large memory servers.

**TYPE:** `tail -f edex-ingest-satellite-20130213.log`

After ingest of each data file is complete, the ingest endpoint prints a single line to the EDEX system log. The format of the log entry is

**INFO** <<date-time>> [thread] Ingest: <<type>>:: <<file name>> <<statistics>>

Where,

<<date-time>> is the date-time stamp (format yyyy-mm-dd hh:mm:ss,ttt)

[thread] identifies the Camel thread that ran the decoder.

<<type>> identifies the data type, e.g. grib, radar, etc.

<<file name>> is the path to the file that was processed.

<<statistics>> lists the ingest statistics for the file. There are two statistics provided; *process time* and *latency* (refer to the note at the end of this section for more information on latency)

The satellite log entry is as follows.

```
INFO 2013-02-13 15:54:30,836 [Ingest.Gini-1] Ingest: EDEX: Ingest - satellite::
/data_store/sat/20130213/15/GOES-15/1545Z_3.9_8km_AK-
REGIONAL_TIGA04_KNES_15636353.satz.2013021315 processed in: 0.0820 (sec) Latency:
0.1280 (sec)
```

**NOTE:** Latency is the elapsed time between when the AWIPS II system first contacts a data file and when the data has been ingested, decoded, and is ready from retrieval by either CAVE or another client application. The “first contact” depends on the data type. For most data types, latency measurement starts when the product has been downloaded by the LDM Writer on CP1f. This latency start time is part of the message generated by the LDM’s EDEX Bridge and sent to QPID (on the CP 1/2 cluster) for processing by EDEX. Note that this latency measure is strictly internal for the AWIPS II data ingest subsystem. This information is logged into the EDEX process logs for every file that is ingested.

### 5.3 *Monitoring the LDM Data Flow and GOES data*

LDM system is used by AWIPS II to transfer data from the SBN to the EDEX ingest processes. In AWIPS II, LDM runs on the CP cluster.

**NOTE:** For data to be made available to the EDEX ingest processors, LDM must be

operational.

The LDM system includes a general administration tool, *ldmadmin*. That tool is used to start and stop the LDM; it also provides some of the monitoring capabilities used in this set of examples.

### 5.3.1 Verifying LDM Operation on the CP cluster

Although *ldmadmin* provides a tool for determining if the LDM is running, it can be easier to use the Linux *ps* utility to verify operation. This example presents the approach for the CP cluster.

- **Scenario 1: Verify LDM Operation Using the Linux *ps* Utility**

```
$ ssh ldm@cpsbn1f
```

```
The authenticity of host 'cpsbn1f (165.92.109.60)' can't be
established.
```

```
RSA key fingerprint is
7d:6b:f6:47:ac:a2:ec:32:8c:17:c0:2a:ba:cb:93:4f.
```

```
Are you sure you want to continue connecting (yes/no)?
```

```
Type <yes>
```

```
ldm@cpsbn1f's password:
```

```
$ ps -u ldm -o user,pid,args
```

USER	PID	COMMAND
ldm	11734	ldmd -I 165.92.29.180 -P 388 -M 256 -m 3600 -o 3600 -q /usr/local/ldm/data/ldm.pq /usr/local/ldm/etc/ldmd.conf
ldm	11736	pqact -e
ldm	11737	edexBridge -vxl /usr/local/ldm/logs/edexBridge.log -s cp1f
ldm	24629	-bash
ldm	24748	ps -u ldm -o user,pid,args

The exact output will vary. Note, however, that the critical lines are those with arguments *ldmd*, *pqact*, and *edexBridge*. These indicate that the various parts of the LDM are operating.

- **Scenario 2: Verify LDM Using the *ldmadmin* Program**

The *ldmadmin* program's *isrunning* option checks to see if the LDM is running. Unfortunately, this option simply returns 0 or 1 and exits; 0 is returned if the LDM is running, and a 1 is returned if it is not running. After executing *ldmadmin isrunning*, you need to check its return value. This sequence should work under most shells:

```
$ ssh ldm@cpsbn1f
```

```
The authenticity of host 'cpsbn1f (165.92.109.60)' can't be
established.
```

```
RSA key fingerprint is
7d:6b:f6:47:ac:a2:ec:32:8c:17:c0:2a:ba:cb:93:4f.
```

```
Are you sure you want to continue connecting (yes/no)?
```

```
    Type <yes>
```

```
ldm@cpsbn1f's password:
```

```
$ ldmadmin isrunning
```

```
$ echo $?
```

```
0
```

```
$
```

This output indicates that the LDM is running. If it were not running, the *echo* *\$?* command would print a 1.

If you are using the *bash* shell, you can combine things slightly and produce a more readable result. The modified command sequence:

```
$ ldmadmin isrunning > /dev/null 2>&1 && echo "Running"
```

```
Running
```

```
$
```

Once again, this output indicates that the LDM is running; if it were not, no output would be displayed.

### 5.3.2 Monitoring LDM Data Flow on the CP or DX Cluster

The *ldmadmin* program provides for real-time monitoring of the LDM product queue. This can be used to determine quickly if data is passing through the LDM; it can also be filtered by data feed to concentrate on a specific data type. Three scenarios are presented: 1) basic product queue monitoring; 2) identifying data feeds; and 3) monitoring a specific data feed.

- **Scenario 1: Basic Product Queue Monitoring**

The *ldmadmin* program's *watch* option provides a real-time view of the LDM's message queue. Monitoring this queue provides a quick verification of the status of the LDM. These are the basic steps to follow:

```
$ ssh ldm@cpsbn1f
```

```
ldm@cpsbn1f's password:
```

```
$ ldmadmin watch
```

```
(type ^D when finished)
```

At this point, you should see output similar to

```

Oct 25 14:51:21 pqutil INFO:      165 20141025145120.701 NEXRAD3
573161214 SDUS33 KILX 251445 /pNMDILX !nids/

Oct 25 14:51:21 pqutil INFO:      51588 20141025145120.705 NEXRAD3
573161215 SDUS21 KLWX 251449 /pNBUOAX !nids/

Oct 25 14:51:21 pqutil INFO:      59852 20141025145120.710 NEXRAD3
573161216 SDUS81 KLWX 251449 /pNBXOAX !nids/

Oct 25 14:51:23 pqutil INFO:       654 20141025145122.701 NEXRAD3
573161217 SDUS72 KMFL 251447 /pNETMIA

Oct 25 14:51:23 pqutil INFO:      1022 20141025145122.701 NEXRAD3
573161218 SDUS53 KLBK 251446 /pDPALNX

Oct 25 14:51:23 pqutil INFO:       118 20141025145122.702 IDS|DDPLUS
573161219 SPCN49 CWA0 251449

Oct 25 14:51:23 pqutil INFO:       383 20141025145122.702 IDS|DDPLUS
573161220 SXXM20 KVAL 251450

Oct 25 14:51:23 pqutil INFO:       118 20141025145122.702 IDS|DDPLUS
573161221 SOVD83 KWNB 251400 RRX

Oct 25 14:51:23 pqutil INFO:       118 20141025145122.702 IDS|DDPLUS
573161222 SOVD83 KWNB 251300 RRX

Oct 25 14:51:23 pqutil INFO:       93 20141025145122.702 IDS|DDPLUS
573161223 SABZ19 SBSL 251500 RRA

Oct 25 14:51:23 pqutil INFO:       275 20141025145122.702 IDS|DDPLUS
573161224 SWPA40 RJTD 251450

Oct 25 14:51:23 pqutil INFO:       89 20141025145122.702 IDS|DDPLUS
573161225 SABZ20 SBBV 251500

Oct 25 14:51:23 pqutil INFO:      18564 20141025145122.703 NEXRAD3
573161226 SDUS81 KLWX 251449 /pNBKOAX !nids/

Oct 25 14:51:23 pqutil INFO:      57605 20141025145122.708 NEXRAD3
573161227 SDUS81 KLWX 251449 /pNBKOAX !nids/

Oct 25 14:51:23 pqutil INFO:      13831 20141025145122.709 NEXRAD3
573161228 SDUS81 KLWX 251449 /pNBHOAX !nids/

Oct 25 14:51:25 pqutil INFO:       392 20141025145124.703 IDS|DDPLUS
573161229 SZHW36 KWBC 251451

Oct 25 14:50:39 pqutil INFO:       144 20141025145038.789 IDS|DDPLUS
109190608 SXXX20 KVAL 251450

Oct 25 14:50:39 pqutil INFO:       168 20141025145038.789 IDS|DDPLUS
109190609 SRCO20 KVAL 251450

Oct 25 14:50:39 pqutil INFO:       212 20141025145038.789 IDS|DDPLUS
109190610 SRSA40 KVAL 251450

Oct 25 14:50:39 pqutil INFO:       120 20141025145038.789 IDS|DDPLUS
109190611 SRCO20 KVAL 251450

Oct 25 14:50:39 pqutil INFO:       178 20141025145038.790 IDS|DDPLUS
109190612 SRKS30 KVAL 251450

```

```

Oct 25 14:50:39 pqutil INFO:      168 20141025145038.790 IDS|DDPLUS
109190613 SRKY20 KWAL 251450

Oct 25 14:50:39 pqutil INFO:      185 20141025145038.790 IDS|DDPLUS
109190614 SRNC20 KWAL 251450

Oct 25 14:50:39 pqutil INFO:      504 20141025145038.790 IDS|DDPLUS
109190615 SXXX20 KWAL 251450

Oct 25 14:50:39 pqutil INFO:      197 20141025145038.790 IDS|DDPLUS
109190616 SRGA20 KWAL 251450

Oct 25 14:50:39 pqutil INFO:      168 20141025145038.790 IDS|DDPLUS
109190617 SRWA20 KWAL 251450

Oct 25 14:50:39 pqutil INFO:      136 20141025145038.790 IDS|DDPLUS
109190618 SXWY50 KWAL 251450

Oct 25 14:50:39 pqutil INFO:      168 20141025145038.790 IDS|DDPLUS
109190619 SXXX50 KWAL 251450

Oct 25 14:50:39 pqutil INFO:      144 20141025145038.790 IDS|DDPLUS
109190620 SRFL20 KWAL 251450

Oct 25 14:50:39 pqutil INFO:      173 20141025145038.790 IDS|DDPLUS
109190621 SROH20 KWAL 251450

Oct 25 14:50:39 pqutil INFO:      216 20141025145038.790 IDS|DDPLUS
109190622 SRAZ20 KWAL 251450

Oct 25 14:50:39 pqutil INFO:      132 20141025145038.790 IDS|DDPLUS
109190623 SROR60 KWAL 251450

Oct 25 14:50:39 pqutil INFO:      216 20141025145038.791 IDS|DDPLUS
109190624 SRTX20 KWAL 251450

```

If data is flowing, this output will scroll past fairly rapidly and the message date time stamp should be current. If no messages are scrolling, it is likely that there is an issue with the LDM.

- **Scenario 2: Identifying LDM Data Feeds**

The *ldmadmin* program's *watch* facility has an option to filter output for a specific feed type. The basic command is *ldmadmin watch -f <feed>*. This scenario presents a method for identifying the available feeds.

The feeds used by LDM are defined in a file named *pqact.conf*, which is located in *<ldm-home>/etc*. While this file can be examined to determine the available feed types, the process can be automated using the known structure of the file and a few basic Linux utilities. The lines defining LDM feeds have the following structure:

```
FEEDTYPE <tab> pattern <tab> action [<tab> options] [<tab> args]
```

Note that lines defining feed types start with at least one uppercase letter. This allows you to filter for the feed definitions and extract the feed names. These are the steps to follow:

```
$ ssh ldm@cpsbn1
```

```
ldm@cpsbn1's password:
$ cd etc
$ grep -P "^[A-Z]+" pqact.conf | cut -f 1 > feeds.txt
$ sort feeds.txt > sorted-feeds.txt
$ uniq sorted-feeds.txt ldm-feeds.txt
$ cat ldm-feeds.txt
ANY
GPSSRC
GRID
HDS
HRS
IDS/DDPLUS
NEXRAD2
NIMAGE
NNEXRAD
$
```

The final output is a sorted list of feed names. The list may differ somewhat depending on the exact data flow configuration for the server. Some of the feed type names are rather cryptic; common feed types are identified in Table 5.3.2-1.

**Table 5.3.2-1. Selected LDM Feed Types**

Feed Name	Description
ANY	wildcard – matches any feed type
GRID	NOAAport high-resolution model output
NEXRAD2	NEXRAD Level II radar data
NIMAGE	NOAAport satellite imagery
NNEXRAD	NEXRAD Level III products

- **Scenario 3: Monitoring a Specific Data Feed**

Log onto the LDM server (CPSBN) as the ldm user. Use the -f option and specify a FEED TYPE to see only products from that LDM feed:

**ldmadmin watch -f NIMAGE**

Press <Ctrl>+<D> to terminate the process.

```
Jun 13 17:40:37 pquutil INFO:      292293 20160613174036.512
NIMAGE 120407663  satz/ch2/GOES-15/WV/20160613 1730/HI-
REGIONAL/4km/ TIGH05 KNES 131730
```

```

Jun 13 17:40:53 pqutil INFO:      4661973 20160613174053.287
NIMAGE 120407738  satz/ch2/GOES-15/VIS/20160613 1730/HI-
REGIONAL/1km/ TIGH01 KNES 131730
Jun 13 17:40:54 pqutil INFO:      292293 20160613174053.538
NIMAGE 120407739  satz/ch2/GOES-15/IR/20160613 1730/HI-
REGIONAL/4km/ TIGH02 KNES 131730

```

To see connections open with ldm:

### netstat -ta | grep ldm

```

tcp          0          0 *:unidata-ldm          ***
LISTEN

```

To monitor the product queue via:

### pqmon

```

Jul 17 18:29:43 pqmon NOTE: Starting Up (5927)
Jul 17 18:29:43 pqmon NOTE: nprods nfree  nempty      nbytes  maxprods
maxfree  minempty  maxext  age
Jul 17 18:29:43 pqmon NOTE: 60048      1 184091 999948616 77061
4      167078      52920 1370
Jul 17 18:29:43 pqmon NOTE: Exiting

```

### ps -U ldm -u ldm u

USER	PID	%CPU	%MEM	VSZ	RSS	TTY	STAT	START	TIME	COMMAND
ldm	16631	0.0	0.0	24004	1200	?	Ss	Jun09	0:02	ldmd -I
165.92.24.50	-P 388	-M 256	-m 3600	-o 3600	-q					/usr/local/ldm/data/ldm
ldm	16633	1.5	3.0	1013216	990444	?	S	Jun09	89:00	pqact -e
ldm	16634	0.1	0.1	224648	34140	?	Sl	Jun09	10:39	edexBridge -
										vx1 /usr/local/ldm/logs/edexBridge.log -s cp1f
root	16635	3.4	3.2	1139568	1078340	?	SLl	Jun09	200:36	
noaaportIngester	-b 10000	-m 224.0.1.1	-n -c -u 3	-t mhs	-r 1	-s NMC				
root	16636	0.3	3.2	1162776	1081164	?	SLl	Jun09	19:17	
noaaportIngester	-b 10000	-m 224.0.1.2	-n -c -f -u 4	-t mhs	-r 1	-s GOES				
root	16637	5.9	4.0	1381788	1320464	?	SLl	Jun09	345:34	
noaaportIngester	-b 10000	-m 224.0.1.3	-n -c -u 5	-t mhs	-r 1	-s NMC2				
root	16638	0.1	3.2	1142084	1064312	?	SLl	Jun09	8:16	
noaaportIngester	-b 10000	-m 224.0.1.4	-n -c -u 6	-t mhs	-r 1	-s NOAAPORT_OPT				
root	16639	0.3	3.2	1154968	1073320	?	SLl	Jun09	19:48	
noaaportIngester	-b 10000	-m 224.0.1.5	-n -c -u 7	-t mhs	-r 1	-s NMC3				
root	16640	0.0	3.2	1136840	1058840	?	SLl	Jun09	0:01	
noaaportIngester	-b 10000	-m 224.0.1.6	-n -c -u 4	-t mhs	-r 1	-s ADD				
root	16641	0.0	3.2	1136840	1058840	?	SLl	Jun09	0:01	
noaaportIngester	-b 10000	-m 224.0.1.7	-n -c -u 7	-t mhs	-r 1	-s ENC				
root	16642	0.0	3.2	1136840	1058840	?	SLl	Jun09	0:01	
noaaportIngester	-b 10000	-m 224.0.1.8	-n -c -u 7	-t mhs	-r 1	-s EXP				

```

root      16643  0.0  3.2 1136840 1055012 ?      SL1  Jun09  0:01
noaaportIngester -b 10000 -m 224.0.1.9 -n -c -u 4 -t mhs -r 1 -s GRW
root      16644  0.0  3.2 1136840 1055012 ?      SL1  Jun09  0:01
noaaportIngester -b 10000 -m 224.0.1.10 -n -c -u 4 -t mhs -r 1 -s GRE

```

## 5.4 GOES Troubleshooting and Tips

### 5.4.1 Troubleshooting

Common problems seen with GOES data and their possible remedies follow.

- **Problem A:** The product loop for incoming images is not auto-updating on a workstation, or products are not available at a workstation.
- **Potential Solution to Problem A:** Check another workstation for similar problems. It may be that only one workstation is having difficulties. If this is the case, exit and restart CAVE on that workstation.
- **Problems B, C, and D**
  - **Problem B:** No GOES product loops are updating at the site.
  - **Problem C:** Data products are arriving late on the workstation.
  - **Problem D:** No GOES products.
- **Potential Solutions to Problems B, C, and D**
  - If the problem is unique to a single workstation, try restarting CAVE. As a last resort, try restarting the workstation.
  - If the problem is more general, try to verify that data is actually available. See section 5.2 for monitoring tools.
  - If data is not available, contact the NCF.

## 5.5 Data Archive Directory

This /data\_store directory lists the SECTOR ID and PHYSICAL ELEMENT of the satellite data.

### Determining Satellite SECTOR ID

```
TYPE:      cd /data_store/sat/<YYYYMMDD>/<HH>
```

```
TYPE:      ls > ~/sat-sectors.txt
```

```
TYPE:      cat ~/sat-sectors.txt
```

```
COMP
```

```
GOES-13
```

```
GOES-15
```



POES

### Determining Satellite PHYSICAL ELEMENT in the Data Archive

**TYPE:** `cd /data_store/sat/20150817/19/GOES-15`

**TYPE:** `ls * | grep -v ":" | grep -P "^\\w" >  
~/sources.txt`

**TYPE:** `sort ~/sources.txt > ~/sorted-sources.txt`

**TYPE:** `uniq ~/sorted-sources.txt ~/sat-sources.txt`

**TYPE:** `cat ~/sat-sources.txt`

```
1900Z_13.3_4km_WEST-CONUS-TIGW06_KNES_139781.satz.2015081719
1900Z_3.9_4km_WEST-CONUS-TIGW04_KNES_139777.satz.2015081719
1900Z_IR_24km_NHEM-COMP-TIGF02_KNES_139787.satz.2015081719
1900Z_IR_4km_WEST-CONUS-TIGW02_KNES_139780.satz.2015081719
1900Z_IR_8km_SUPER-NATIONAL-TIGN02_KNES_139785.satz.2015081719
1900Z_VIS_14km_HI-NATIONAL-TIGI01_KNES_30002463.satz.2015081719
1900Z_VIS_1km_WEST-CONUS-TIGW01_KNES_139779.satz.2015081719
1900Z_VIS_24km_NHEM-COMP-TIGF01_KNES_139789.satz.2015081719
1900Z_VIS_8km_SUPER-NATIONAL-TIGN01_KNES_139788.satz.2015081719
1900Z_WV_24km_NHEM-COMP-TIGF05_KNES_139786.satz.2015081719
1900Z_WV_4km_WEST-CONUS-TIGW05_KNES_139778.satz.2015081719
1900Z_WV_8km_SUPER-NATIONAL-TIGN05_KNES_139783.satz.2015081719
1901Z_SOUND-3.98_10km_WEST-CONUS-TIGW57_KNES_139795.satz.2015081719
1901Z_SOUND-4.45_10km_WEST-CONUS-TIGW55_KNES_139800.satz.2015081719
1901Z_SOUND-6.51_10km_WEST-CONUS-TIGW52_KNES_139801.satz.2015081719
1901Z_SOUND-7.02_10km_WEST-CONUS-TIGW51_KNES_139796.satz.2015081719
1901Z_SOUND-7.43_10km_WEST-CONUS-TIGW50_KNES_139794.satz.2015081719
1901Z_SOUND-VIS_10km_WEST-CONUS-TIGW59_KNES_139802.satz.2015081719
1910Z_13.3_4km_WEST-CONUS-TIGW06_KNES_139793.satz.2015081719
1910Z_3.9_4km_WEST-CONUS-TIGW04_KNES_139791.satz.2015081719
1910Z_IR_4km_WEST-CONUS-TIGW02_KNES_139792.satz.2015081719
1910Z_VIS_1km_WEST-CONUS-TIGW01_KNES_139790.satz.2015081719
1924Z_SOUND-11.03_10km_HI-NATIONAL-TIGI48_KNES_139845.satz.2015081719
```

1924Z\_SOUND-14.06\_10km\_HI-NATIONAL-TIGI43\_KNES\_139844.satz.2015081719  
1924Z\_SOUND-3.98\_10km\_HI-NATIONAL-TIGI57\_KNES\_139851.satz.2015081719  
1924Z\_SOUND-4.45\_10km\_HI-NATIONAL-TIGI55\_KNES\_139849.satz.2015081719  
1924Z\_SOUND-6.51\_10km\_HI-NATIONAL-TIGI52\_KNES\_139848.satz.2015081719  
1924Z\_SOUND-7.02\_10km\_HI-NATIONAL-TIGI51\_KNES\_139847.satz.2015081719  
1924Z\_SOUND-7.43\_10km\_HI-NATIONAL-TIGI50\_KNES\_139846.satz.2015081719  
1924Z\_SOUND-VIS\_10km\_HI-NATIONAL-TIGI59\_KNES\_139850.satz.2015081719  
1930Z\_13.3\_4km\_WEST-CONUS-TIGW06\_KNES\_139815.satz.2015081719  
1930Z\_3.9\_4km\_HI-REGIONAL-TIGH04\_KNES\_30014428.satz.2015081719  
1930Z\_3.9\_4km\_WEST-CONUS-TIGW04\_KNES\_139813.satz.2015081719  
1930Z\_3.9\_8km\_AK-REGIONAL-TIGA04\_KNES\_30014323.satz.2015081719  
1930Z\_IR\_14km\_HI-NATIONAL-TIGI02\_KNES\_30015484.satz.2015081719  
1930Z\_IR\_24km\_NHEM-COMP-TIGF02\_KNES\_139819.satz.2015081719  
1930Z\_IR\_4km\_HI-REGIONAL-TIGH02\_KNES\_30014429.satz.2015081719  
1930Z\_IR\_4km\_WEST-CONUS-TIGW02\_KNES\_139814.satz.2015081719  
1930Z\_IR\_8km\_AK-NATIONAL-TIGB02\_KNES\_30015411.satz.2015081719  
1930Z\_IR\_8km\_AK-REGIONAL-TIGA02\_KNES\_30014324.satz.2015081719  
1930Z\_IR\_8km\_SUPER-NATIONAL-TIGN02\_KNES\_139817.satz.2015081719  
1930Z\_VIS\_14km\_HI-NATIONAL-TIGI01\_KNES\_30015684.satz.2015081719  
1930Z\_VIS\_1km\_HI-REGIONAL-TIGH01\_KNES\_30014515.satz.2015081719  
1930Z\_VIS\_1km\_WEST-CONUS-TIGW01\_KNES\_139811.satz.2015081719  
1930Z\_VIS\_24km\_NHEM-COMP-TIGF01\_KNES\_139821.satz.2015081719  
1930Z\_VIS\_2km\_AK-REGIONAL-TIGA01\_KNES\_30014404.satz.2015081719  
1930Z\_VIS\_8km\_AK-NATIONAL-TIGB01\_KNES\_30015410.satz.2015081719  
1930Z\_VIS\_8km\_SUPER-NATIONAL-TIGN01\_KNES\_139820.satz.2015081719  
1930Z\_WV\_14km\_HI-NATIONAL-TIGI05\_KNES\_30015485.satz.2015081719  
1930Z\_WV\_24km\_NHEM-COMP-TIGF05\_KNES\_139818.satz.2015081719  
1930Z\_WV\_4km\_HI-REGIONAL-TIGH05\_KNES\_30014430.satz.2015081719  
1930Z\_WV\_4km\_WEST-CONUS-TIGW05\_KNES\_139812.satz.2015081719  
1930Z\_WV\_8km\_AK-NATIONAL-TIGB05\_KNES\_30015483.satz.2015081719  
1930Z\_WV\_8km\_AK-REGIONAL-TIGA05\_KNES\_30014336.satz.2015081719  
1930Z\_WV\_8km\_SUPER-NATIONAL-TIGN05\_KNES\_139816.satz.2015081719  
1940Z\_13.3\_4km\_WEST-CONUS-TIGW06\_KNES\_139838.satz.2015081719

```
1940Z_3.9_4km_WEST-CONUS-TIGW04_KNES_139836.satz.2015081719
1940Z_IR_4km_WEST-CONUS-TIGW02_KNES_139835.satz.2015081719
1940Z_VIS_1km_WEST-CONUS-TIGW01_KNES_139834.satz.2015081719
```

## 5.6 *Data Archive Directory*

To add the Himawari menu item into D2D:

- 1) Open a terminal window and log onto either DX3 or DX4/
- 2) Copy the himawari-index.xml file to the site level:

```
cp
/awips2/edex/data/utility/common_static/base/menus/satellite/himawari/himawari-index.xml
/awips2/edex/data/utility/common_static/site/<site>/menus/satellite/himawari/himawari-index.xml
```

- 3) The Himawari menu can be added into the top menu bar in D2D or into the satellite menu depending on which line is enabled. The himawari-index.xml contains comments describing which <include> element performs which action. Modify the site level file by removing the comments tags "<!--" and "-->" from around one of the <include> items. Then save the file.

## **Chapter 6**

### **Ingest of NWSTG Data**

## Chapter 6: Ingest of NWSTG Data

### Table of Contents

	<i>Page</i>
6.1 Overview .....	1
6.2 Gridded Data .....	2
6.2.1 Data Archive and File Naming Conventions .....	5
6.2.2 Decoding the Grib Data .....	6
6.2.3 Data Ingest and Logging of Grib Data .....	6
6.2.4 Data Archive and File Naming Conventions for Other Gridded Data .....	10
6.2.5 Decoding Other Gridded Data .....	10
6.2.6 Data Ingest and Logging of Other Gridded Products .....	10
6.3 Lightning Data .....	12
6.3.1 Data Archive and File Naming Conventions for Lightning Data .....	12
6.3.2 Decoding Lightning Data .....	15
6.3.3 Data Ingest and Logging of Lightning Products .....	15
6.4 METAR Data .....	16
6.4.1 Data Archive and File Naming Conventions for Metar Data .....	19
6.5 MOS Data .....	23
6.5.1 Data Archive and File Naming Conventions for MOS Data .....	23
6.5.2 Decoding BufrMOS Data .....	25
6.5.3 Data Ingest and Logging of BufrMOS Products .....	26
6.6 Decoding BUFR Data .....	29
6.6.1 Data Archive and File Naming Conventions for the BUFR Data .....	29
6.6.2 Decoding BUFR Data .....	36
6.6.3 Data Ingest and Logging of BUFR Products .....	37
6.7 Decoding Synoptic Observation Data .....	39
6.7.1 Data Archive and File Naming Conventions for Synoptic Data .....	40
6.7.2 Decoding Synoptic Data .....	42
6.7.3 Data Ingest and Logging of Synoptic Products .....	42
6.8 Decoding Special Sensor Microwave Imager .....	43
6.8.1 Data Archive and File Naming Conventions for SSM/I Data .....	45
6.8.2 Decoding SSM/I Data .....	45
6.8.3 Data Ingest and Logging of SSM/I Products .....	45
6.9 convSIGMET Data .....	46
6.9.1 Data Archive and File Naming Conventions for convSIGMET Data .....	46
6.9.2 Decoding convSIGMET Data .....	47
6.9.3 Data Ingest and Logging of ConvSIGMET Products .....	47

6.10 Tracing NWSTG (TAF) Products Using the Sequence Number .....	48
6.11 Add NCEPs GFS-DNG (for Guam) to AWIPS .....	51
6.12 Decrypting Lightning Data.....	51

### **List of Exhibits**

Exhibit 6.2-1. NWSTG (grib and non-grib) Data Flow .....	3
Exhibit 6.2.3-1. Acquire and Ingest of NWSTG Products.....	7
Exhibit 6.3-1. Acquire and Ingest of Lightning Products .....	14
Exhibit 6.4-1. Acquire and Ingest of METAR Products .....	18
Exhibit 6.5-1. Acquire and Ingest of MOS Products .....	24
Exhibit 6.6-1. Acquire and Ingest of BUFR Products .....	30
Exhibit 6.7-1. Acquire and Ingest of Synoptic Products.....	41
Exhibit 6.8-1. Acquire and Ingest of SSM/I Products .....	44

### **List of Tables**

Table 6.6.2-1. BUFR Data: Directories and File Names .....	37
Table 6.6.2-2. Report Code Definitions.....	37
Table 6.7-1. Data URI Codes for Various Synoptic Observation Types .....	40

## 6.1 Overview

The main source of nationally distributed data for AWIPS is the Satellite Broadcast Network (SBN). The SBN delivers products over four channels; the product sets for the NWSTG and NWSTG2 channels include the following:

- NCEP and other model outputs      GFS, GFS Ensembles, NGM, NAM, MesoNAM, NOGAPS, RAP13, RAP40, ECMWF, UKMET, GWW, QPE, FFG, SNOW, ENSEMBLE, GLERL, RTGSST, DGEX, HPCGuide and Multiple-Radar / Multiple-Sensor system (MRMS). Note: MRMS has been activated in OB14.4.1.
- BUFR data      NAM Model Soundings, GOES Soundings, POES Soundings, ACARS, QuikSCAT ocean winds, GOES High Density Winds, NAM, GFS, NCWF, ASCAT and SSM/I
- Surface observations      METAR, lightning, maritime, hydro
- Upper air observations      RAOB, profiler, aircraft
- Other text products      TAF, CCF, and other coded and plain language text products
- NCEP Redbook graphics      Digitized graphics produced by NCEP.

This chapter describes the methods by which AWIPS receives the following data products:

- Gridded data (Section 6.2)
- Lightning data (Section 6.3)
- METAR data (Section 6.4)
- MOS data (Section 6.5)
- BUFR data (Section 6.6)
- Synoptic observation data (Section 6.7)
- SSM/I data (Section 6.8)
- ConvSIGMET data (Section 6.9)

The chapter concludes with guidance on tracing NWSTG (TAF) products using the sequence number (Section 6.10).

In this release, the GFS-based DNG products will be provided by NCEP in GRIB2 format, via the SBN. The WMO headers for these products will be [L/M]\*G\*\*\* KWBT.

The GFS-based DNG products will be produced for the 0000, 0600, 1200 and 1800 UTC model cycles with output every 3 hours from 0 to 192 hours after model initialization time. The Guam DNG products are horizontally interpolated from the 27 km GFS native grid to the 2.5 km mercator NDFD grid for Guam. This is the so-called grid 199, whose grid specification is at:

<http://www.nco.ncep.noaa.gov/pmb/docs/on388/tableb.html#GRID199> Vertical interpolation to the high resolution terrain is performed at NCEP using Smartinit.

## **6.2 *Gridded Data***

The data flow for the NWSTG (grib and non-grib) data is illustrated in Exhibit 6.2-1. As the exhibit shows, the data flow is a 12-step process. Descriptions of each step follow.



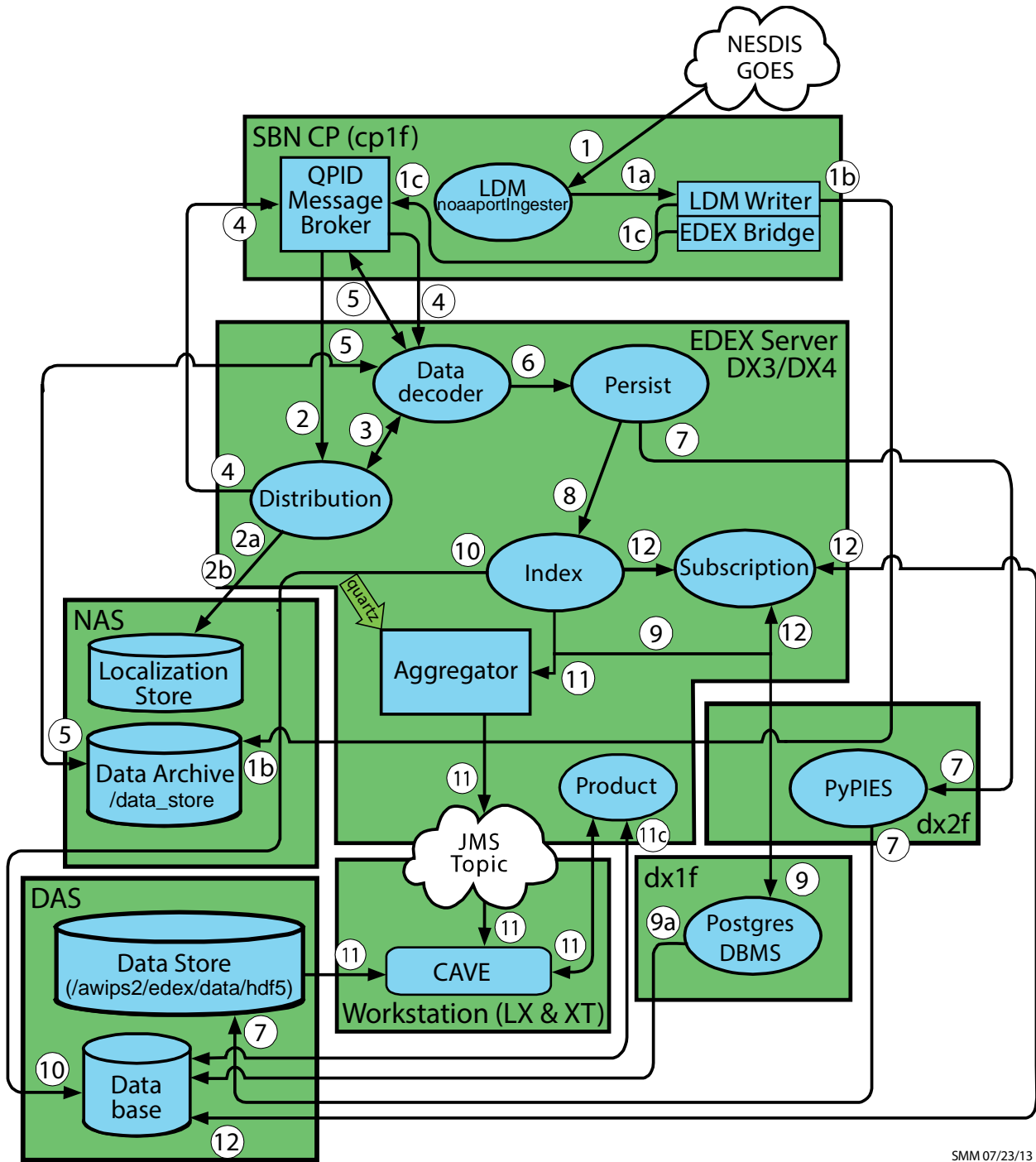

SMM 07/23/13

Exhibit 6.2-1. NWSSTG (grib and non-grib) Data Flow

1. NWSTG data (grib and non-grib) are obtained by the LDM noaaportIngester from the SBN. Most gridded model data is produced by the NCEP. This data is transmitted over the NWSTG channel of the SBN in GRIB (Gridded Binary) or GRIB2 format.
  - a. The LDM noaaportIngester forwards the product to the LDM Writer instance.
  - b. The LDM Writer instance writes the product to the Data Archive. The Data Archive (/data\_store) directory is mounted on the hosts off the NAS [NAS2].
  - c. The LDM Writer instance uses the EDEX Bridge to post a message containing product information to the QPID Message Broker. The product information is the WMO header and the path to the product file.
2. The EDEX Distribution endpoint on the EDEX (DX) cluster pulls the message from the QPID Message Broker. The WMO header is matched against data distribution mappings contained in the data distribution directory to determine product routing. (The WMO header is included in the message; if it is not, the Distribution service uses the product file name from the message to determine routing.) *Note:* The files in the data distribution directory are XML files that contain regular expressions that match WMO headers with the appropriate data decoder plug-in.
  - a. At EDEX startup, the EDEX Distribution endpoint reads the Data Distribution files from the Data Distribution directory in the Localization Store. It uses the contents of these files to generate the routing table used to determine data routing. The Data Distribution directory is located at /awips2/edex/data/utility/edex\_static/base/distribution.
  - b. The EDEX Distribution endpoint monitors the Data Distribution directory; when a file in that directory is modified, it re-reads that file and rebuilds its routing table.
3. The EDEX Distribution Service determines the Data Decoder Plug-In registered to handle the data in the product file.
4. The EDEX Distribution Service forwards the message to the appropriate Data Decoder Plug-In via the QPID Message Broker.
5. The EDEX Data Decoder Service on the EDEX (DX) cluster pulls the data type specific message from the QPID Message broker. The Data Decoder Service reads the file pointed to by the message, decodes the data, and determines the appropriate metadata.
6. The decoded data and metadata are sent to the EDEX Persist endpoint.
7. The EDEX Persist endpoint sends the data to PyPIES, and PyPIES writes the data to the EDEX data store in HDF5 format.
8. The EDEX Persist endpoint sends the metadata obtained to the EDEX Index endpoint.
9. The EDEX Index endpoint sends the metadata to the PostgreSQL DBMS.

- a. The PostgreSQL DBMS writes the metadata to the database.
10. The EDEX Index endpoint extracts the Data URI for the product from the metadata.
11. (Client notification) The Data URI is forwarded to the EDEX URI Aggregator.
- a. Every 5 seconds the aggregated Data URIs are sent to the JMS Alert Topic.
  - b. CAVE monitors the JMS Alert Topic to obtain a list of available Data. CAVE determines if it should render the available data.
  - c. CAVE retrieves metadata from the EDEX server via a product query sent to the EDEX thrift endpoint.
  - d. CAVE retrieves product data from the EDEX server by accessing the EDEX data store's HDF5 files and CAVE renders the data, updating its display as appropriate.
12. (Subscription) The Data URI is forwarded to the EDEX Subscription endpoint.
- a. The EDEX Subscription endpoint checks the active subscription list to determine if a subscription has been registered for the product.
    - 1) If no subscription has been registered for the product, no further action is taken.
  - b. The EDEX Subscription endpoint obtains the script information from the database.
  - c. The EDEX Subscription endpoint obtains a micro-engine to execute the script.
    - 1) The micro-engine executes the subscription script for the product.

### 6.2.1 Data Archive and File Naming Conventions

Most gridded model data is produced by the NCEP. This data is transmitted over the NWSTG channel of the SBN in GRIB (Gridded Binary) or GRIB2 format. They are stored in data archive.

The raw grib files are stored in the Data Archive (/data\_store/grib or /data\_store/grib2). The physical directory (/data\_store) is on the NAS. All the hosts mount the volume off NAS.

In addition, when new products are being tested, they are stored under /data\_store/experimental/grib.

Data Storage (also known as Data Archive) is not standard across all grids anymore. It is generally stored at /data\_store/grib/<YYYYMMDD>/<HH>/GRID\_NAME/GRID\_TYPE e.g., /data\_store/grib/20130211/12/NWS\_161/GRID255/2300Z\_F001\_APCP-ZETA98\_KFWR\_111214\_63882903.grib.2013021220

and

/data\_store/grib2/<YYYYMMDD>/<HH>/GRID\_NAME/GRID\_TYPE

e.g., /data\_store/grib/20130211/17/RUC2/GRID130/ 1700Z\_F018\_WXTZ-LMDN98\_KWBG\_121700\_38969009.grib2.2013021218

LDM server runs only on the SBN CP. It ingests everything from the SBN.

LDM behavior is controlled by the pqact.conf file, and the patterns are matched against **pqact.conf**. LDM writes the product to data\_store and posts a QPID message.

- **pqact.conf** controls how data sent to an instance of LDM is handled. This includes the data types to be handled and the location of the raw data archive.

- **NOTE:** Modifying pqact.conf will have a severe impact on the data flow.

### 6.2.2 Decoding the Grib Data

Data decoding operations are performed on the EDEX (DX3/4) servers. Both EDEX servers share the load in the ingest process, which includes decoding the raw data, writing the decoded data into the Data Store, writing metadata to the database, and broadcasting a notification that the newly ingested data is available.

The processed data is stored in /awips2/edex/data/hdf5 in the hdf5 format on the dx2f server. The processed grib data is under /awips2/edex/data/hdf5/grid.

- The basic directory structure is  
/awips2/edex/data/hdf5/grid/{GRID\_TYPE}/{model\_type}.
- Within each model, a separate HDF5 file is maintained for each forecast hour of a model run. The naming convention for the HDF5 files is {model}-yyyy-mm-dd-hh-FH-{forecasthour}.h5. For example, the GFS212 1200Z 0 forecast hour from Feb. 12, 2013 is in a file named GFS212-2013-02-12-12-FH-000.h5.
- The internal structure of the HDF5 file reflects the Data URI, which is part of the metadata stored in the PostgreSQL database.

### 6.2.3 Data Ingest and Logging of Grib Data

As illustrated in Exhibit 6.2.3-1, all data ingest operations are logged in the EDEX logs on the EDEX (DX3/4) server. In a standard installation, the EDEX logs are located in /awips2/edex/logs. This directory contains several log files; the files starting with “edex-” are the EDEX logs.

- EDEX logs roll over daily and are date stamped. The naming convention for EDEX logs is edex-{instance name}-yyyymmdd.log.
- For the grib decoder, the instance name is “ingestGrib”, so the GRIB ingest logs for May 19, 2013 are named edex-ingestGrib-20130519.log. Note that there should be one log on both of the EDEX servers (DX3/4).

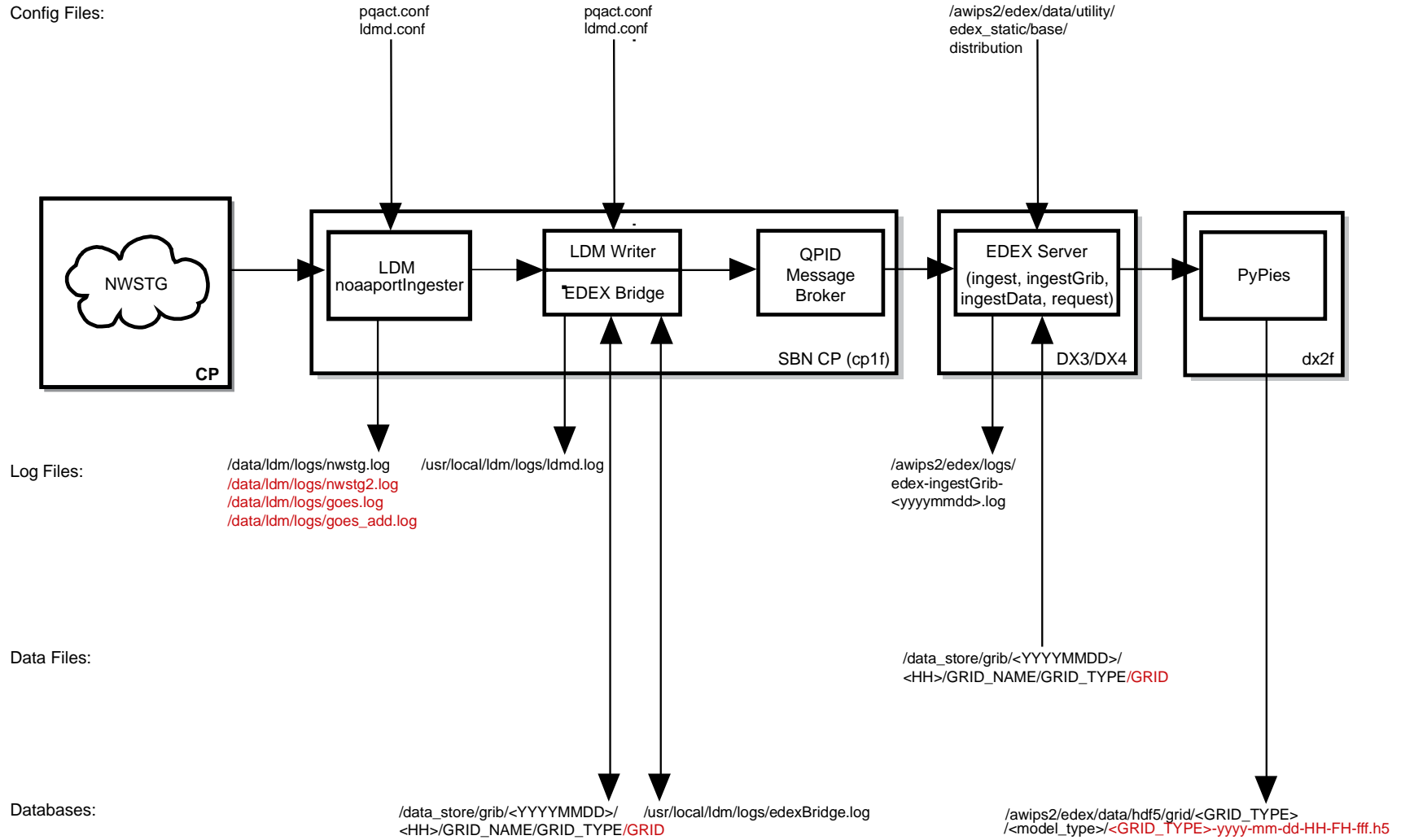

Exhibit 6.2.3-1. Acquire and Ingest of NWSTG Products

The log file is a plain ASCII text file and can be viewed using any text viewing utility such as *more*, *less*, *view*, or *tail*.

Open a terminal session to the server and enter the following commands:

#### On DX3/DX4

**TYPE:** `cd /awips2/edex/logs`

**TYPE:** `date +%F`

**2013-05-19**

**TYPE:** `ls edex*20130519*`

```
edex-ingest-20130519.log
edex-ingestDat-20130519.log
edex-ingest-gen_areal_ffg-20130519.log
edex-ingest-gen_areal_qpe-20130519.log
edex-ingestGrib-20130519.log
edex-ingest-purge-20130519.log
edex-ingest-radar-20130519.log
edex-ingest-satellite-20130519.log
edex-ingest-shef-20130519.log
edex-ingest-shef-performance-20130519.log
edex-ingest-smartInit-20130519.log
edex-ingest-text-20130519.log
edex-ingest-unrecognized-files-20130519.log
edex-request-20130519.log
edex-request-productSrvRequest-20130519.log
edex-request-thriftSrv-20130519.log
edex-ingest-archive-20130519.log
edex-ingest-activeTableChange-20130519.log
edex-ingestGrib-performance-20130519.log
edex-ingest-performance-20130519.log
edex-request-performance-20130519.log
edex-ingest-gen_areal_qpe-20130519.log
edex-request-hibernate-20130519.log
edex-ingest-hibernate-20130519.log
edex-ingest-ohd-20130519.log
edex-request-textdbSrvRequest-20130519.log
edex-ingestDat-performance-20130519.log
edex-ingest-sportlma-20130519.log
edex-ingestGrib-hibernate-20130519.log
```

**TYPE:** `tail -f edex-ingestGrib-20130519.log`

A log entry for grib is

```
INFO 2016-04-16 00:00:05,058 [GribPersist-2] Ingest: EDEX:
Ingest - grib2::
/data_store/grib2/20160415/18/GFS/GRID213/1800Z_F228_HGHT5-
LHHX50_KWBC_151800_65379468.grib2.2016041600 processed in:
0.0460 (sec) Latency: 0.0820 (sec)
```

```
INFO 2016-04-16 00:00:05,058 [GribPersist-2] GridPersister:
EDEX - Processed: [1/42.8kB/37ms] to /GFS213/MB/grid-2016-
04-15-18.h5, in process on other threads: [5/914.4kB],
pending: [2/85.6kB]
```

```
INFO 2016-04-16 00:00:00,080 [GribPersist-4] Ingest: EDEX:
Ingest - grib2::
/data_store/grib2/20160415/18/GFS/GRID217/1800Z_F228_VREL_YV
BX70_KWBC_151800_65379424.grib2.2016041523 processed in:
0.0440 (sec) Latency: 0.1080 (sec)
```

```
INFO 2016-04-16 00:00:00,080 [GribPersist-4] GridPersister:
EDEX - Processed: [1/230.4kB/21ms] to /GFS217/MB/grid-2016-
04-15-18.h5, in process on other threads: [4/901.3kB],
pending: [0/0.0B]
```

Refer to App Y, Configuring the NetCDF Grid Decoder for the patterns.

**NOTE:** Latency is the elapsed time between when the AWIPS II system first contacts a data file and when the data has been ingested, decoded, and is ready for retrieval by CAVE or another client application. The “first contact” depends on the data type. For most data types, latency measurement starts when the product has been downloaded by the LDM Writer on cp1f. This latency start time is part of the message generated by the LDM’s EDEX Bridge and sent to QPID (on the CP1/2 cluster) for processing by EDEX. For Radar products obtained from the ORPG via the AWIPS II Radar Server, latency measurement starts when the product is downloaded by the Radar Server on the DX1/2 cluster. In the case of ORPG products, the latency start time is part of the message sent by the Radar Server to QPID. Note that this latency measure is strictly internal for the AWIPS II data ingest subsystem. This information is logged into the EDEX process logs for every file that is ingested. Additional latency can occur, for example, due to communication issues between the Radar Server and the ORPG. Other sources of latency are possible. For example (this is a hypothetical example), if a client application queries a server each minute for available products, there is an average latency of 30 seconds in that query. To quantify, or even to identify, all possible sources of latency in a system is beyond the scope of this discussion.

Also in the example below, you can see a GribGridPointLock message illustrating a Large Grib file.

```
INFO 2015-05-26 00:00:11,009 [Ingest.GribDecode-4]
GribGridPointLock: EDEX - Large grib file is using
```

```
many grid points: (2953665 of 6000000):
/data_store/grib2/20150525/17/URMA/GRID184/1700Z_F000_
DRCTAERR-LNQA98_KWBR_251700_8297468.grib2.2015052600
```

```
Took 330 ms to receive response for StoreRequest on
file grid/URMA25/FHAG/URMA25-2015-05-25-17-FH-000.h5
```

#### 6.2.4 Data Archive and File Naming Conventions for Other Gridded Data

The remaining gridded data (other than GRIB1 and GRIB2) received over the SBN are stored in the following directory.

```
/data_store/grib/<YYYYMMDD>/<HH>/GRID_NAME/GRID_TYPE
```

#### 6.2.5 Decoding Other Gridded Data

Data decoding operations for the Gridded Data (other than GRIB1 and GRIB2) are performed on the EDEX (DX3/4) servers. Both EDEX servers share the load in the ingest process, which includes decoding the raw data, writing the decoded data into the Data Store, writing metadata to the database, and broadcasting a notification that the newly ingested data is available.

The processed data is stored in /awips2/edex/data/hdf5 in the hdf5 format on the dx2f server. The processed Gridded Data (other than GRIB1 and GRIB2) are under /awips2/edex/data/hdf5/grid.

The basic directory structure is  
/awips2/edex/data/hdf5/grid/<GRID\_TYPE>/<model\_type>

Within each model, a separate HDF5 file is maintained for each model run. The naming convention for the HDF5 files is \*yyyy-mm-dd-hhmm\*.h5.

```
/awips2/edex/data/hdf5/grid/AVN211/BL/AVN211-2013-02-12-06-FH-
240.h5
```

```
/awips2/edex/data/hdf5/grid/AVN211/Dflt/AVN211-2013-02-12-06-
FH-000.h5
```

```
/awips2/edex/data/hdf5/grid/AVN225/SFC/AVN225-2013-02-12-06-
FH-120.h5
```

The internal structure of the HDF5 file reflects the Data URI, which is part of the metadata stored in the PostgreSQL database

#### 6.2.6 Data Ingest and Logging of Other Gridded Products

All data ingest operations are logged in the EDEX logs on the EDEX (DX3/4) server. In a standard installation, the EDEX logs are located in /awips2/edex/logs. This directory contains several log files; the files starting “edex-” are the EDEX logs.



The log file is a plain ASCII text file and can be viewed using any text viewing utility such as *more*, *less*, *view*, or *tail*.

Open a terminal session to the server and enter the following commands:

**On DX3/DX4:**

```
[root@dx3-tbdw ~]# cd /awips2/edex/logs
```

```
[root@dx3-tbdw logs]# date +%F
```

```
TYPE:      date +%F
```

```
2013-05-19
```

```
TYPE:      ls edex*20130519*
```

```
edex-ingest-20130519.log
edex-ingestDat-20130519.log
edex-ingest-gen_areal_ffg-20130519.log
edex-ingest-gen_areal_qpe-20130519.log
edex-ingestGrib-20130519.log
edex-ingest-purge-20130519.log
edex-ingest-radar-20130519.log
edex-ingest-satellite-20130519.log
edex-ingest-shef-20130519.log
edex-ingest-shef-performance-20130519.log
edex-ingest-smartInit-20130519.log
edex-ingest-text-20130519.log
edex-ingest-unrecognized-files-20130519.log
edex-request-20130519.log
edex-request-productSrvRequest-20130519.log
edex-request-thriftSrv-20130519.log
edex-ingest-archive-20130519.log
edex-ingest-activeTableChange-20130519.log
edex-ingestGrib-performance-20130519.log
edex-ingest-performance-20130519.log
edex-request-performance-20130519.log
edex-ingest-gen_areal_qpe-20130519.log
edex-request-hibernate-20130519.log
edex-ingest-hibernate-20130519.log
edex-ingest-ohd-20130519.log
edex-request-textdbSrvRequest-20130519.log
edex-ingestDat-performance-20130519.log
edex-ingest-sportlma-20130519.log
edex-ingestGrib-hibernate-20130519.log
```

```
[root@dx3-tbdw logs]# tail -f edex-ingestGrib-20130519.log
```

After ingest of each data file is complete, the ingest endpoint prints a single line to the EDEX system log. The format of the log entry is

**INFO <<date-time>> [thread] Ingest: <<type>>:: <<file name>> <<statistics>>**

The product sequence number is to the left of the .grb (\_<seq>.grb).

The log entry:

```
INFO 2016-04-16 00:00:00,917 [GribPersist-2] Ingest: EDEX:
Ingest - grib2::
/data_store/grib2/20160415/22/161/GRID255/2238Z_F000_MrgRefQCCom-
YAUC01_KWNR_152238_65379418.grib2.2016041523 processed in: 0.9130
(sec) Latency: 0.9450 (sec)
```

### 6.3 *Lightning Data*

Lightning data is collected by the National Lightning Detection Network (NLDN), Global Lightning Dataset (GLD), and Earth Networks Total Lightning (ENI) and received from the SBN. This data set contains the location that a lightning strike was detected (given by latitude and longitude) and the time that the flash occurred, recorded to the nearest second. The lightning flash's signal strength is recorded in kiloamperes. Also included is the multiplicity and polarity (either positive or negative) of each flash.

**NOTE:** For more information on the proprietary nature of the lightning data and redistribution restrictions, please refer to: [http://www.nco.ncep.noaa.gov/sib/restricted\\_data/restricted\\_data\\_pmb/lightning/](http://www.nco.ncep.noaa.gov/sib/restricted_data/restricted_data_pmb/lightning/)

See Exhibit 6.3-1 for the flow of the acquisition and ingest of lightning products.

#### 6.3.1 *Data Archive and File Naming Conventions for Lightning Data*

The raw lightning files received over the SBN are stored in the Data Archive (/data\_store/binlightning and /data\_store/entlightning). The physical directory (/data\_store) is on the NAS. All the hosts mount the volume off NAS.

The basic directory structure is /data\_store/binlightning/<YYYYMMDD>/<HH>

e.g.,

```
/data_store/binlightning/20130212/20/SFUS41_KWBC_122058_288873682.nldn.20130
212202
```

The ent lightning files received over the SBN are stored in the Data Archive (/data\_store/entlightning). The physical directory (/data\_store) is on the NAS. All the hosts mount the volume off NAS.

The basic directory structure is /data\_store/entlightning/<YYYYMMDD>/<HH>

e.g.,

/data\_store/entlightning/20130212/20/SFPA42\_KWBC\_262029\_201198.2015052620

Note: Data decoding operations for the Lightning Data are performed on the EDEX (DX3/4) servers by the TotalLightningDecoder

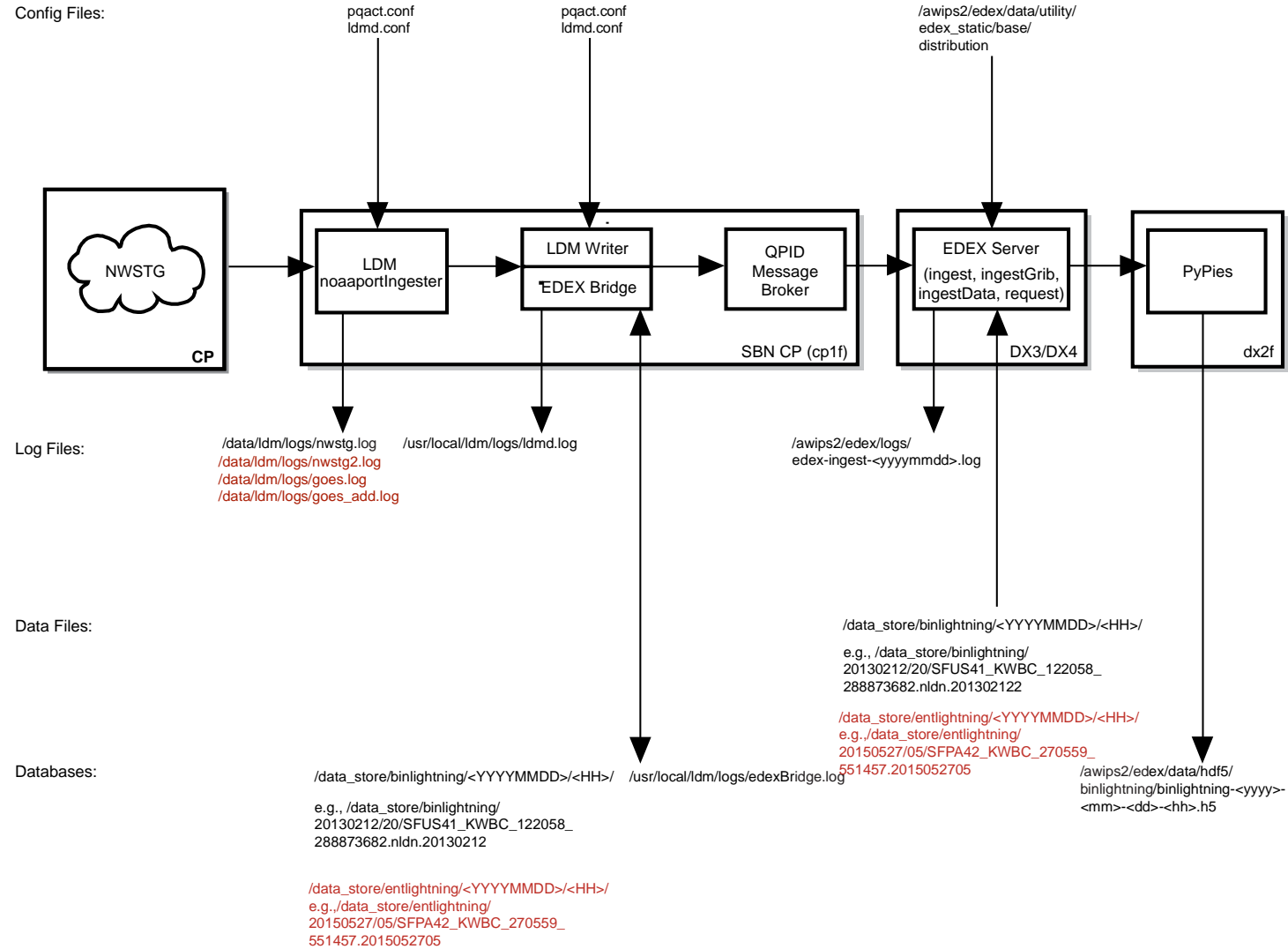

**Exhibit 6.3-1. Acquire and Ingest of Lightning Products**

### 6.3.2 Decoding Lightning Data

Data decoding operations are performed on the EDEX (DX3/4) servers by the TotalLightning Decoder or the BinLightning Decoder. Both EDEX servers share the load in the ingest process, which includes decoding the raw data, writing the decoded data into the Data Store, writing metadata to the database, and broadcasting a notification that the newly ingested data is available.

The processed data files are stored in /awips2/edex/data/hdf5 in the hdf5 format on the dx2f server. The processed lightning data files are stored under /awips2/edex/data/hdf5/binlightning

The basic directory structure is:

```

    /awips2/edex/data/hdf5/binlightning/binlightning-<yyyy>-<mm>-<dd>-<hh>.h5
[root@dx2-tbdw binlightning] # ls /awips2/edex/data/hdf5/binlightning/
    binlightning-2013-02-13-11.h5
    binlightning-2013-02-13-12.h5

```

### 6.3.3 Data Ingest and Logging of Lightning Products

All data ingest operations are logged in the EDEX logs on the EDEX (DX3/4) server. In a standard installation, the EDEX logs are located in /awips2/edex/logs. This directory contains several log files; the files starting “edex-” are the EDEX logs.

The log file is a plain ASCII text file and can be viewed using any text viewing utility such as *more*, *less*, *view*, or *tail*.

To get a general view of processing, open a terminal session to the server and enter the following commands:

#### On DX3/DX4:

```

TYPE:      cd /awips2/edex/logs

TYPE:      date +%F

2013-02-13

TYPE:      ls edex*20130213*

edex-ingest-20130213.log
edex-ingestDat-20130213.log
edex-ingest-gen_areal_ffg-20130213.log
edex-ingest-gen_areal_qpe-20130213.log
edex-ingestGrib-20130213.log
edex-ingest-purge-20130213.log

```

```

edex-ingest-radar-20130213.log
edex-ingest-satellite-20130213.log
edex-ingest-shef-20130213.log
edex-ingest-shef-performance-20130213.log
edex-ingest-smartInit-20130213.log
edex-ingest-text-20130213.log
edex-ingest-unrecognized-files-20130213.log
edex-request-20130213.log
edex-request-productSrvRequest-20130213.log
edex-request-thriftSrv-20130213.log
edex-ingest-archive-20130213.log
edex-ingest-activeTableChange-20130213.log
edex-ingestGrib-performance-20130213.log
edex-ingest-performance-20130213.log
edex-request-performance-20130213.log
edex-ingest-gen_areal_qpe-20130213.log
edex-request-hibernate-20130213.log
edex-ingest-hibernate-20130213.log
edex-ingest-ohd-20130213.log
edex-request-textdbSrvRequest-20130213.log
edex-ingestDat-performance-20130213.log
edex-ingest-sportlma-20130213.log
edex-ingestGrib-hibernate-20130213.log

```

**TYPE:** tail -f edex-ingest-20130213.log

After ingest of each data file is complete, the ingest endpoint prints a single line to the EDEX system log. The format of the log entry is

**INFO** <<date-time>> [thread] Ingest: <<type>>:: <<file name>> <<statistics>>

A log entry will be as follows.

```

INFO 2015-05-26 13:56:04,289 [Ingest.binlightning-1] Ingest:
EDEX: Ingest - binlightning::
/data_store/binlightning/20150526/12/SFUS41_KWBC_261255_6120.nldn
.2015052613 processed in: 0.0300 (sec) Latency: 0.0630 (sec)

```

```

INFO 2015-05-26 13:56:49,406 [Ingest.binlightning-1] Ingest:
EDEX: Ingest - binlightning::
/data_store/entlightning/20150526/13/SFPA42_KWBC_261355_8733430.2
015052613 processed in: 0.0850 (sec) Latency: 0.3500 (sec)

```

## 6.4 METAR Data

METAR data is received over the NWSTG channel of the SBN. The raw data arrive in text format as one singular report or as a collective report that contains data from several stations.

See Exhibit 6.4-1 for the flow of the acquisition and ingest of METAR products.

Config Files:

pqact.conf  
ldmd.conf

pqact.conf  
ldmd.conf

/awips2/edex/data/utility/  
edex\_static/base/  
distribution

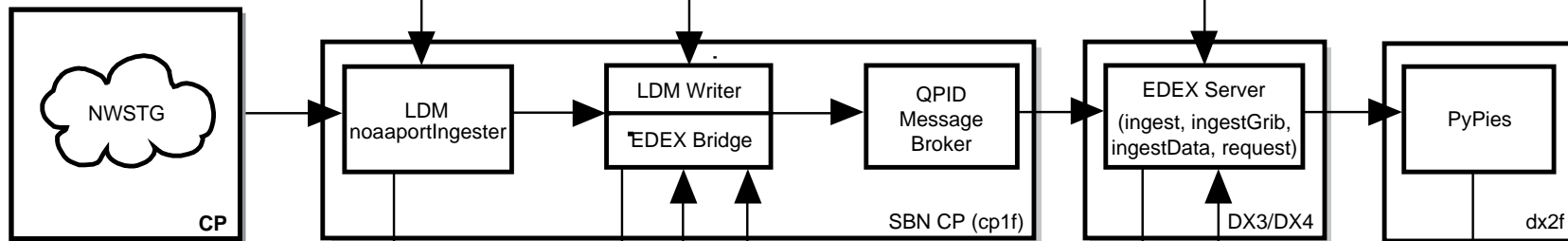

Log Files:

/data/ldm/logs/nwstg.log /usr/local/ldm/logs/ldmd.log  
/data/ldm/logs/nwstg2.log  
/data/ldm/logs/goes.log  
/data/ldm/logs/goes\_add.log

/awips2/edex/logs/  
edex-ingest-<yyyymmdd>.log

Data Files:

/data\_store/metar/<YYYYMMDD>/<HH>

Databases:

/data\_store/metar/<YYYYMMDD>/<HH> /usr/local/ldm/logs/edexBridge.log

/awips2/edex/data/hdf5/  
metar/metar-yy-mm-dd-hh.h5

**Exhibit 6.4-1. Acquire and Ingest of METAR Products**



### 6.4.1 *Data Archive and File Naming Conventions for Metar Data*

Metar data received from the SBN is written by the LDM to the /data\_store/metar directory, which is available on all boxes. It contains folders for the past (site-determined) number of days, each containing 24 directories representing the hours in which these products were stored. For example, under /data\_store/metar/20150713/23, you will find all observations received between 23z and 24z on that date. Typical file names are:

```
SPZZ40_KAWN_202333_129590324.2015071323
```

```
SAUS44_KCRP_202336_129596616.2015071323
```

The first two characters denote an observation type (SA = regular observation; SP = special observation). The third and fourth characters denote the country (US = United States; MX = Mexico; CN = Canada).

In the first entry (SPZZ40\_KAWN), 202333 denotes the day/hour/minute from the WMO header, and 129590324 represents the unique sequence number assigned by the NWSTG at transmission over the SBN. It is the number used for automatic product re-ships.

**Note:** KWBC files are often, but not always, collectives.

### 6.4.2 *Decoding Metar data*

METAR data is decoded by the obs decoder, which is part of the EDEX ingest process running on the dx3/4 cluster. Metadata for the METAR data is stored in the obs table of the metadata database. The processed METAR data is then auto-fed into the METAR-to-SHEF process.

**Note:** processed METAR files are not stored in /awips2/edex/data/hdf5/metar on the dx2f server.

### 6.4.3 *Data Ingest and Logging of Metar Products*

All data ingest operations are logged in the EDEX log files, located in /awips2/edex/logs on the EDEX dx3/dx4 cluster. After ingest of each data file is complete, the ingest endpoint writes to the current edex-ingest-yyyymmdd log file, for example:

```
INFO 2015-07-22 00:00:08,335 [Ingest.obs-1] Ingest: EDEX: Ingest -
obs:: /data_store/metar/20150722/00/SAUS70_KWBC_220000_393875370.
2015072200 processed in: 0.1630 (sec) Latency: 0.2160 (sec)
```

### 6.4.4 *Metar2Shef Data Processing*

METAR data gets fed into the Metar2shef decoder, which is now part of EDEX. The METAR-to-SHEF process is controlled by a combination of XML filters, options / switches, and the contents of a configuration file. (The terms 'options' and 'switches' are

used interchangeably here to reference the arguments supplied to the Metar2shef decoder by the `metar2shef_options` token in the `Apps_defaults` file.) **Note:** If any changes are made to `metarToShefFilter.xml`, the `metar.cfg` file, or the `metar2shef_options` token, EDEX must be restarted to pick up the revisions.

### 6.4.5 *Metar2Shef Filters*

The Metar2shef decoder has been absorbed into EDEX. Which metars get processed is determined by elements in `/awips2/edex/data/utility/edex_static/site/XXX/plugin-filters/metarToShefFilter.xml`, a filter file on the dx3/dx4 cluster (where XXX is the uppercase 3-character site ID).

EDEX uses `metarToShefFilter.xml` to determine if a METAR station's data should be SHEF-encoded. (See *Appendix H.1* for the format and description of this file.) As METAR data is processed within EDEX, each station is checked against all filters provided in each element in this file, to determine SHEF-encoding eligibility. Once a station becomes eligible, its contents are encoded in SHEF according to options / switches set in `Apps_defaults` tokens, and configuration settings in the `metar.cfg` file.

An XML file can contain only one of the two types of root elements that are available for the filter file:

- Element `<pluginDataObjectFilter>` is designed for a single METAR configuration file with one set of METAR-to-SHEF options to be applied to all METAR stations.
- Element `<metarToShefFilter>` is designed for one or more METAR configuration files each with a different set of METAR-to-SHEF options.

There are 4 ways that the Metar2shef plug-in filter can select the data it will accept for processing. It can specify:

- 1) a lat/lon box around the WFO for which MTRs will be ingested and decoded into the IHFS database,
- 2) a radius around the WFO,
- 3) individual MTR stations, or
- 4) WMOIDs for particular MTR products.

Any violation of XML syntax will result in an error in the edex ingest logs upon EDEX restart. (See *Appendix I* for more details.)

Once a station is deemed eligible for SHEF encoding by a filter element, filter element processing for that station stops. The METAR data is then auto-fed into the METAR-to-SHEF process.

### 6.4.6 *Metar2Shef Configuration File*

The configuration file `/awips2/edex/data/utility/common_static/site/XXX/shef/metar.cfg` determines which elements from the METAR report get transformed to SHEF. One line specifies the PE codes that will be processed, and up to three special segments may add more filtering and options. When set up correctly it provides a flexible way for the user to provide options to the decoder.

A sample configuration file is shown below; for descriptions of the fields, see *Appendix H.3*. Note that although the first 6 lines are no longer used in AWIPS II, they must be kept in the file for backward compatibility. Thus processing begins with line 7, the line specifying the Physical Element (PE) codes to be decoded.

Depending on the switches that are set by the `metar2shef_options` token (described below) in the `Apps_defaults` file, the segments following line 7 (`begin` and `end names`, `begin` and `end sm_alias`, and `begin` and `end pc_reset`) may be used to further filter the metars that are being ingested.

```

/tmp/queue/metar/in
/tmp/queue/metar/out
/tmp/queue/metar/err
+SAOOUT
-ERRORFILE
-SHEFPASS
TA UP SD UD US TX TN PPT PPQ PPH PPD PA TAIRZR TAIRZH TAIRZP
TAIRZY
.begin_names
KP01
KP06
KIFP
KCGZ
.end_names
.begin_sm_alias
12123 ABCA3
12323 ABGA3
.end_sm_alias
.begin_pc_reset
CJR 55
.end_pc_reset

```

If the configuration file needs changes to be made, it should be edited using the CAVE Localization perspective (Hydro -> SHEF). If changes have been made to the `metar.cfg` file, EDEX must be restarted to pick up the revisions, since the METAR-to-SHEF process is controlled by a combination of options / switches, and the contents of the configuration file.

### 6.4.7 *Metar2Shef Options*

The `metar2shef_options` token in the AWIPS2 `Apps_defaults` file specifies the options (or

‘switches’) to be used by the Metar2shef decoder in processing metar data, for example:  
 metar2shef\_options : " -a -b -p1 -y2k -salias -p6 -p24 -round -w -strip -v -pct 5"

The complete list of options and their meanings are shown in Appendix H.4.

The switch settings currently in use are captured in the EDEX log files on the dx3/dx4 cluster. As each metar is being processed, the ingest endpoint writes them to the current /awips2/edex/logs/edex-ingest-yyyyymmdd log file, for example:

```
INFO 2015-08-20 00:00:09,846 [Ingest.obs-1] MetarToShefTransformer: Metar to SHEF for KHLX use config file: metar.cfg with options: -a -b -p1 -y2k -salias -p6 -p24 -round -w -strip -v -pct 5
```

**Note:** AWIPS I used tokens metar\_config\_dir, metar\_log\_dir, or metar\_output\_dir in the Apps\_defaults file to specify directories -- AWIPS2 does not use them at all.

### 6.4.8 Metar2Shef Logging

The Metar2shef decoder output is auto-fed to the SHEF decoder. By default, no SHEF output files are created by the METAR-to-SHEF process.

In the /awips2/edex/logs directory, Metar2shef processing is logged in edex-ingest-yyyyymmdd.log files and SHEF processing is logged in edex-ingest-shef-yyyyymmdd.log files.

Searching for “MetarToShefTransformer” in the ingest log for example, shows the options specified by the metar2shef\_options token in the Apps\_defaults file:

```
INFO 2015-07-22 00:00:08,336 [Ingest.obs-1] MetarToShefTransformer: Metar to SHEF for K1A5 use config file: metar.cfg with options:-a -b -p1 -p6 -p24 -w -strip -q1
Searching for "WBC" in the SHEF log, for example, shows values posted and errors:
INFO 2015-08-20 00:00:10,030 [Ingest.ShefStaged-1] ShefSeparator: EDEX - TraceId set to WMOHeader = SRXX99 KCXY 200000
ERROR 2015-08-20 00:00:10,031 [Ingest.ShefStaged-1] PurgeText: AWIPS Header [WBCMTRCXY] too long, truncating to 6 characters
INFO 2015-08-20 00:00:10,033 [Ingest.ShefStaged-1] PostShef: EDEX -
=====
INFO 2015-08-20 00:00:10,033 [Ingest.ShefStaged-1] PostShef: EDEX - Posting process started for LID [CXY] PEDTSEP [TARZZI] value [82]
INFO 2015-08-20 00:00:10,034 [Ingest.ShefStaged-1] PostShef: EDEX - CXY Adjusting Value for CXY
INFO 2015-08-20 00:00:10,036 [Ingest.ShefStaged-1] PostShef: EDEX - Posted product link [WBCMTRCXY] for LID [CXY]
INFO 2015-08-20 00:00:10,038 [Ingest.ShefStaged-1] PostShef: EDEX - Data [82] ObsTime[Wed Aug 19 23:56:00 GMT 2015] for LID [CXY] posted to the latestObsValue for PE [TA]
INFO 2015-08-20 00:00:10,039 [Ingest.ShefStaged-1] PostShef: EDEX - Posting data [82] for LID [CXY] for PE [TA]
INFO 2015-08-20 00:00:10,039 [Ingest.ShefStaged-1] PostShef: EDEX -
=====
INFO 2015-08-20 00:00:10,039 [Ingest.ShefStaged-1] PostShef: EDEX - Posting
```

```
process started for LID [CXY] PEDTSEP [TDRZZI] value [68]
--
INFO 2015-08-20 00:00:10,082 [Ingest.ShefStaged-1] ShefDecoder: EDEX -
/data_store/metar/20150820/00/SAUS70_KWBC_200000_497675082.2015082000- Decode
complete in 52 milliSeconds
INFO 2015-08-20 00:00:10,082 [Ingest.ShefStaged-1] Ingest: EDEX: Ingest -
shef:: /data_store/metar/20150820/00/SAUS70_KWBC_200000_497 675082.2015082000
processed in: 0.1490 (sec) Latency: 0.5710 (sec)
```

**Note:** To see what SHEF is created, set the “-v” switch in the metar2shef\_options token in the Apps\_defaults file, which will record, in the edex-ingest-yyyyymmdd.log file, up to 35 lines of SHEF data for each metar processed.

## 6.5 MOS Data

The MOS data is received over the SBN’s NWSTG channel.

See Exhibit 6.5-1 for the flow of the acquisition and ingest of MOS products.

### 6.5.1 Data Archive and File Naming Conventions for MOS Data

The MOS data received over the SBN are stored in the following directory.

```
/data_store/bufrmos/{YYYYMMDD}
```

Under <YYYYMMDD> you will find folders ranging from 00 through 23.

```
[root@dx1-tbdw bufrmos]# ls /data_store/bufrmos/{YYYYMMDD}
```

```
00 02 04 06 08 10 12 14 16 18 20 22
01 03 05 07 09 11 13 15 17 19 21 23
```

If you change to /data\_store/bufrmos/20130213/00, you will find all the guidance issued between 00z and 01z.

Here is an example with the GFSLAMP, GFS, ETA, HPC, NGM, and MRF files under the MOS data.

```
JSMF10_KWNO_300000_143710496.bufr.2013021300 (GFSLAMP)
JSML36_KWNO_300000_144004297.bufr.2013021300 (GFS)
JSML12_KWNO_061200_3526466.bufr.2013021300 (ETA)
JSMT72_KWNH_060000_3461881.bufr.2013021300 (HPC)
JSMT42_KWNH_060000_3875681.bufr.2013021300 (NGM)
JSMT62_KWNO_060000_3784680.bufr.2013021300 (MRF)
```

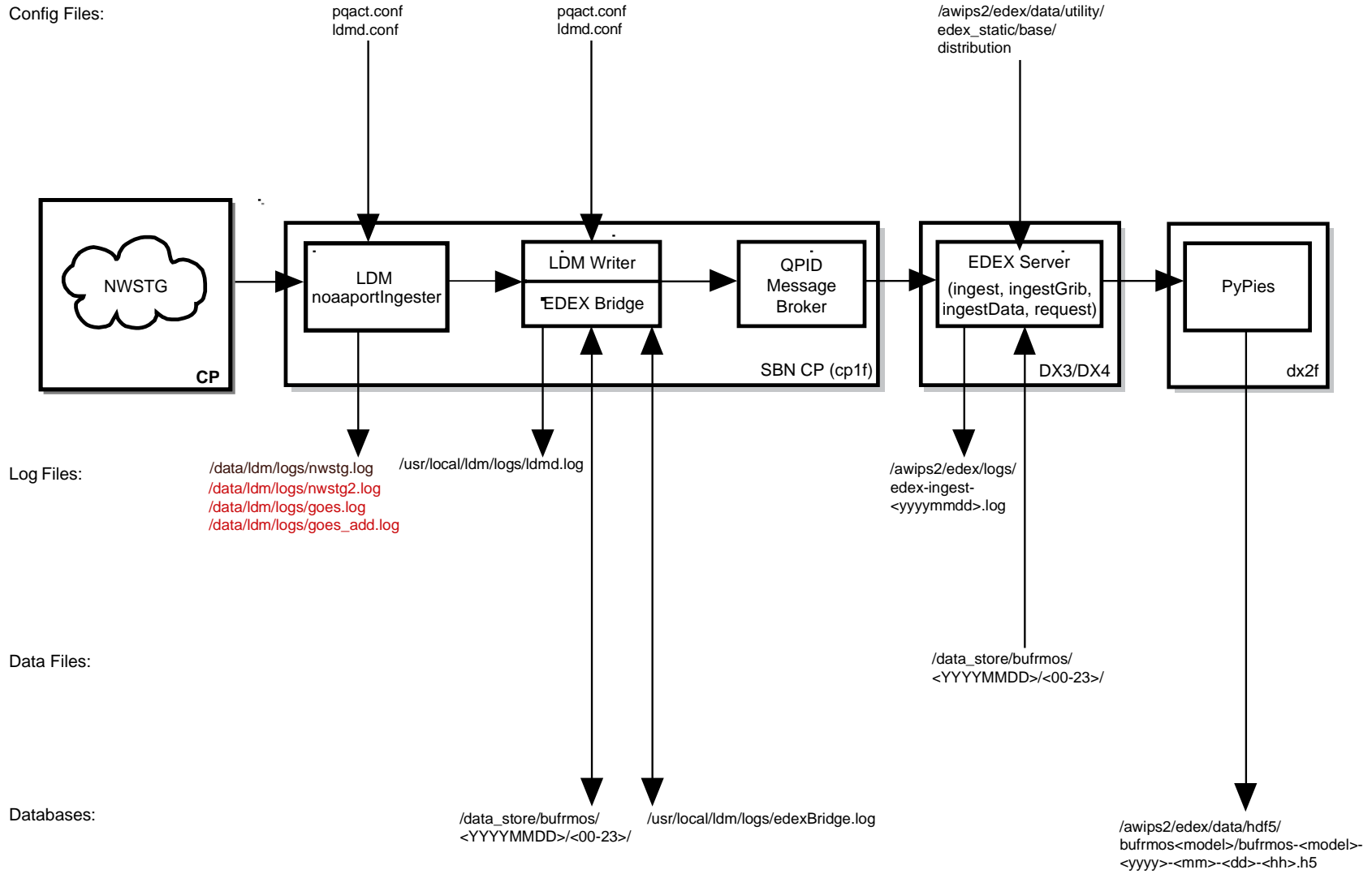

**Exhibit 6.5-1. Acquire and Ingest of MOS Products**

If you change to /data\_store/bufrmos/20130213/00, you will find all the guidance issued between 00z and 01z.

Here is an example with the GFSLAMP, GFS, ETA, HPC, NGM, and MRF files under the MOS data.

```
JSMF10_KWNO_300000_143710496.bufr.2013021300 (GFSLAMP)
JSML36_KWNO_300000_144004297.bufr.2013021300 (GFS)
JSML12_KWNO_061200_3526466.bufr.2013021300 (ETA)
JSMT72_KWNH_060000_3461881.bufr.2013021300 (HPC)
JSMT42_KWNH_060000_3875681.bufr.2013021300 (NGM)
JSMT62_KWN0_060000_3784680.bufr.2013021300 (MRF)
```

### 6.5.2 Decoding BufrMOS Data

Data decoding operations are performed on the EDEX (DX3/4) servers. Both EDEX servers share the load in the ingest process, which includes decoding the raw data, writing the decoded data into the Data Store, writing metadata to the database, and broadcasting a notification that the newly ingested data is available.

The processed data files are stored in /awips2/edex/data/hdf5 in the hdf5 format on the dx2f server. The processed MOS data files are stored under their respective types as follows.

All ingested bufrmosLAMP data is under

/awips2/edex/data/hdf5/bufrmosLAMP/<model>-<yyyy>-<mm>-<dd>-<hh>.h5

E.g.: /awips2/edex/data/hdf5/bufrmosLAMP/bufrmos-LAMP-2013-02-13-11.h5

All ingested bufrmosGFS data is under /awips2/edex/data/hdf5/bufrmosGFS/<bufrmos-model>-<yyyy>-<mm>-<dd>-<hh>.h5

E.g.: /awips2/edex/data/hdf5/bufrmosGFS/bufrmos-GFS-2013-02-13-11.h5

All ingested bufrmosETA data is under /awips2/edex/data/hdf5/bufrmosETA/<bufrmos-model>-<yyyy>-<mm>-<dd>-<hh>.h5

E.g.: /awips2/edex/data/hdf5/bufrmosETA/bufrmos-ETA-2013-02-13-11.h5

All ingested bufrmosHPC data is under /awips2/edex/data/hdf5/bufrmosHPC/<bufrmos-model>-<yyyy>-<mm>-<dd>-<hh>.h5

E.g.: /awips2/edex/data/hdf5/bufrmosHPC/bufrmos-HPC-2013-02-13-11.h5

All ingested bufrmosMRF data is under /awips2/edex/data/hdf5/bufrmosMRF/<bufrmos-model>-<yyyy>-<mm>-<dd>-<hh>.h5

E.g.: /awips2/edex/data/hdf5/bufrmosMRF/bufrmos-MRF-2013-02-13-00.h5

All ingested bufrmosAVN data is under /awips2/edex/data/hdf5/bufrmosAVN/<bufrmos-model>-<yyyy>-<mm>-<dd>-<hh>.h5

E.g.: /awips2/edex/data/hdf5/bufrmosAVN/bufrmos-AVN-2013-02-13-11.h5

### 6.5.3 Data Ingest and Logging of BufrMOS Products

All data ingest operations are logged in the EDEX logs on the EDEX (DX3/4) server. In a standard installation, the EDEX logs are located in /awips2/edex/logs. This directory contains several log files; the files starting “edex-” are the EDEX logs.

Open a terminal session to the server and enter the following commands:

#### On DX3:

```
[root@dx3-tbdw ~]# cd /awips2/edex/logs
[root@dx3-tbdw logs]# date +%F
2013-02-13
[root@dx3-tbdw logs]# ls edex-*20130213*
edex-ingest-20130213.log
edex-ingestDat-20130213.log
edex-ingest-gen_areal_ffg-20130213.log
edex-ingest-gen_areal_qpe-20130213.log
edex-ingestGrib-20130213.log
edex-ingest-purge-20130213.log
edex-ingest-radar-20130213.log
edex-ingest-satellite-20130213.log
edex-ingest-shef-20130213.log
edex-ingest-shef-performance-20130213.log
edex-ingest-smartInit-20130213.log
edex-ingest-text-20130213.log
edex-ingest-unrecognized-files-20130213.log
edex-request-20130213.log
edex-request-productSrvRequest-20130213.log
edex-request-thriftSrv-20130213.log
edex-ingest-archive-20130213.log
edex-ingest-activeTableChange-20130213.log
edex-ingestGrib-performance-20130213.log
edex-ingest-performance-20130213.log
edex-request-performance-20130213.log
edex-ingest-gen_areal_qpe-20130213.log
edex-request-hibernate-20130213.log
edex-ingest-ohd-20130213.log
edex-request-textdbSrvRequest-20130213.log
edex-ingestDat-performance-20130213.log
edex-ingest-hibernate-20130213.log
```



```
edex-ingest-sportlma-20130213.log
edex-ingestGrib-hibernate-20130213.log
```

```
[root@dx3-tbdw logs]# grep bufrmos edex-ingest-20130213.log | tail -1
INFO 2013-02-13 01:31:39,886 [Ingest.bufrmos-1] Ingest: EDEX:
Ingest - bufrmos::
/data_store/bufrmos/20130213/01/JSMT12_KWNO_130100_140688156.bufr
.2013021301 processed in: 22.4460 (sec) Latency: 22.4960 (sec)
```

```
[root@dx3-tbdw logs]# ssh dx4 "grep bufrmos /awips2/edex/logs/edex-
ingest-20130213.log | tail -1"
INFO 2013-02-13 01:32:40,379 [Ingest.bufrmos-1] Ingest: EDEX:
Ingest - bufrmos::
/data_store/bufrmos/20130213/01/JSMT11_KWNO_130100_140688159.bufr
.2013021301 processed in: 36.5160 (sec) Latency: 77.8500 (sec)
```

The following are examples of looking for a specific bufrmos types by using the AWIPS1 acq\_patterns.txt ingest pattern threads. The grep examples should be performed on both dx3 and dx4.

#### For GFS extended MRF data:

```
^JSMT6[1-6].*
^JSMT7[1-6].KWNO.*
```

```
[root@dx3-tbdw logs]# grep "JSMT6[1-6]" edex-ingest-20130213.log
INFO 2013-02-13 04:56:32,460 [Ingest.bufrmos-1] Ingest: EDEX:
Ingest - bufrmos::
/data_store/bufrmos/20130213/00/JSMT61_KWNO_130000_289705344.bufr
.2013021304 processed in: 17.7870 (sec) Latency: 468.8820 (sec)
INFO 2013-02-13 05:10:26,226 [Ingest.bufrmos-1] Ingest: EDEX:
Ingest - bufrmos::
/data_store/bufrmos/20130213/00/JSMT61_KWNO_130000_289705344.bufr
.2013021304 processed in: 10.7000 (sec) Latency: 773.6920 (sec)
```

#### For HPC data:

```
^JSMT7[1-6].KWNH.*
```

```
[root@dx3-tbdw logs]# grep "JSMT7[1-6].KWNH" edex-ingest-
20130213.log
INFO 2013-02-13 05:48:57,669 [Ingest.bufrmos-1] Ingest: EDEX:
Ingest - bufrmos::
/data_store/bufrmos/20130213/00/JSMT72_KWNH_130000_289796705.bufr
.2013021305 processed in: 1.2540 (sec) Latency: 1.2620 (sec)
INFO 2013-02-13 05:48:57,644 [Ingest.bufrmos-1] Ingest: EDEX:
Ingest - bufrmos::
```

```
/data_store/bufrmos/20130213/00/JSMT72_KWNH_130000_289796705.bufr
.2013021305 processed in: 1.5430 (sec) Latency: 1.5480 (sec)
```

**For GFS data:**

```
^JSML3[1-6].*
```

```
[root@dx3-tbdw logs]# grep "JSML3[1-6]" edex-ingest-20130213.log
```

```
INFO 2013-02-13 16:13:03,842 [Ingest.burmos-1] Ingest: EDEX:
Ingest - bufrmos::
/data_store/bufrmos/20130213/12/JSML31_KWNO_131200_290879900.bufr
.2013021316 processed in: 75.4930 (sec) Latency: 129.7540 (sec)
INFO 2013-02-13 10:04:15,255 [Ingest.burmos-1] Ingest: EDEX:
Ingest - bufrmos::
/data_store/bufrmos/20130213/06/JSML31_KWNO_130600_290252901.bufr
.2013021310 processed in: 44.2560 (sec) Latency: 121.8810 (sec)
```

**For ETA data:**

```
^JSML1[1-6].*
```

```
[root@dx3-tbdw logs]# grep "JSML1[1-6]" edex-ingest-20130213.log
```

```
INFO 2013-02-13 03:10:25,800 [Ingest.burmos-1] Ingest: EDEX:
Ingest - bufrmos::
/data_store/bufrmos/20130213/00/JSML14_KWNO_130000_289523915.bufr
.2013021303 processed in: 22.4940 (sec) Latency: 32.8410 (sec)
INFO 2013-02-13 03:16:58,055 [Ingest.burmos-1] Ingest: EDEX:
Ingest - bufrmos::
/data_store/bufrmos/20130213/00/JSML14_KWNO_130000_289523915.bufr
.2013021303 processed in: 40.6400 (sec) Latency: 76.4190 (sec)
```

**For GFSLAMP data:**

```
^JSMF1[1-6].KWNO.*
```

```
[root@dx3-tbdw logs]# grep "JSMF1[1-6].KWNO" edex-ingest-
20130213.log
```

```
INFO 2013-02-13 04:32:47,074 [Ingest.burmos-1] Ingest: EDEX:
Ingest - bufrmos::
/data_store/bufrmos/20130213/04/JSMF12_KWNO_130400_140763561.bufr
.2013021304 processed in: 43.7080 (sec) Latency: 100.7060 (sec)
INFO 2013-02-13 05:31:53,762 [Ingest.burmos-1] Ingest: EDEX:
Ingest - bufrmos::
/data_store/bufrmos/20130213/05/JSMF12_KWNO_130500_140785879.bufr
.2013021305 processed in: 28.2150 (sec) Latency: 70.0650 (sec)
```

## 6.6 *Decoding BUFR Data*

Data ingested in BUFR format includes model soundings, GOES soundings, POES soundings, ACARS data, GOES High Density Wind (hdw) data, QuikSCAT ocean wind data, mtsat High Density Wind (mtsathdw), and ncwf.

See Exhibit 6.6-1 for the flow of the acquisition and ingest of BUFR products.

### 6.6.1 *Data Archive and File Naming Conventions for the BUFR Data*

The Bufr data (miscellaneous point data) received over the SBN are stored in the following directories.

#### **For model soundings:**

/data\_store/model sounding/{YYYYMMDD}

```
[root@dx3-tbdw model sounding]# ls /data_store/model sounding/20130213
```

```
02 04 08 10 14 16 20 21 22
```

```
[root@dx3-tbdw model sounding]# ls /data_store/model sounding/20130213/02
```

```
JUSB43_KWNO_130200_289500745.bufr.2013021302
```

```
JUSX49_KWNO_130200_289523811.bufr.2013021302
```

```
JUSB43_KWNO_130200_289500746.bufr.2013021302
```

```
JUSX49_KWNO_130200_289523813.bufr.2013021302
```

```
JUSB43_KWNO_130200_289500747.bufr.2013021302
```

```
JUSX49_KWNO_130200_289523821.bufr.2013021302
```

```
JUSB43_KWNO_130200_289500748.bufr.2013021302
```

```
JUSX49_KWNO_130200_289523871.bufr.2013021302
```

#### **For GOES soundings:**

data\_store/goessndg/{YYYYMMDD}

```
[root@dx3-tbdw data_store]# ls /data_store/goessounding/20130213
```

```
00 02 04 06 08 10 12 14 16 18 20 22
```

```
01 03 05 07 09 11 13 15 17 19 21 23
```

```
[root@dx3-tbdw 02]# ls /data_store/goessounding/20130213/08
```

```
JUTX04_KNES_130824_290073061.bufr.2013021308
```

```
JUTX07_KNES_130806_290045707.bufr.2013021308
```

```
JUTX04_KNES_130824_290073066.bufr.2013021308
```

```
JUTX07_KNES_130806_290045711.bufr.2013021308
```

```
JUTX04_KNES_130824_290073069.bufr.2013021308
```

```
JUTX07_KNES_130806_290045712.bufr.2013021308
```

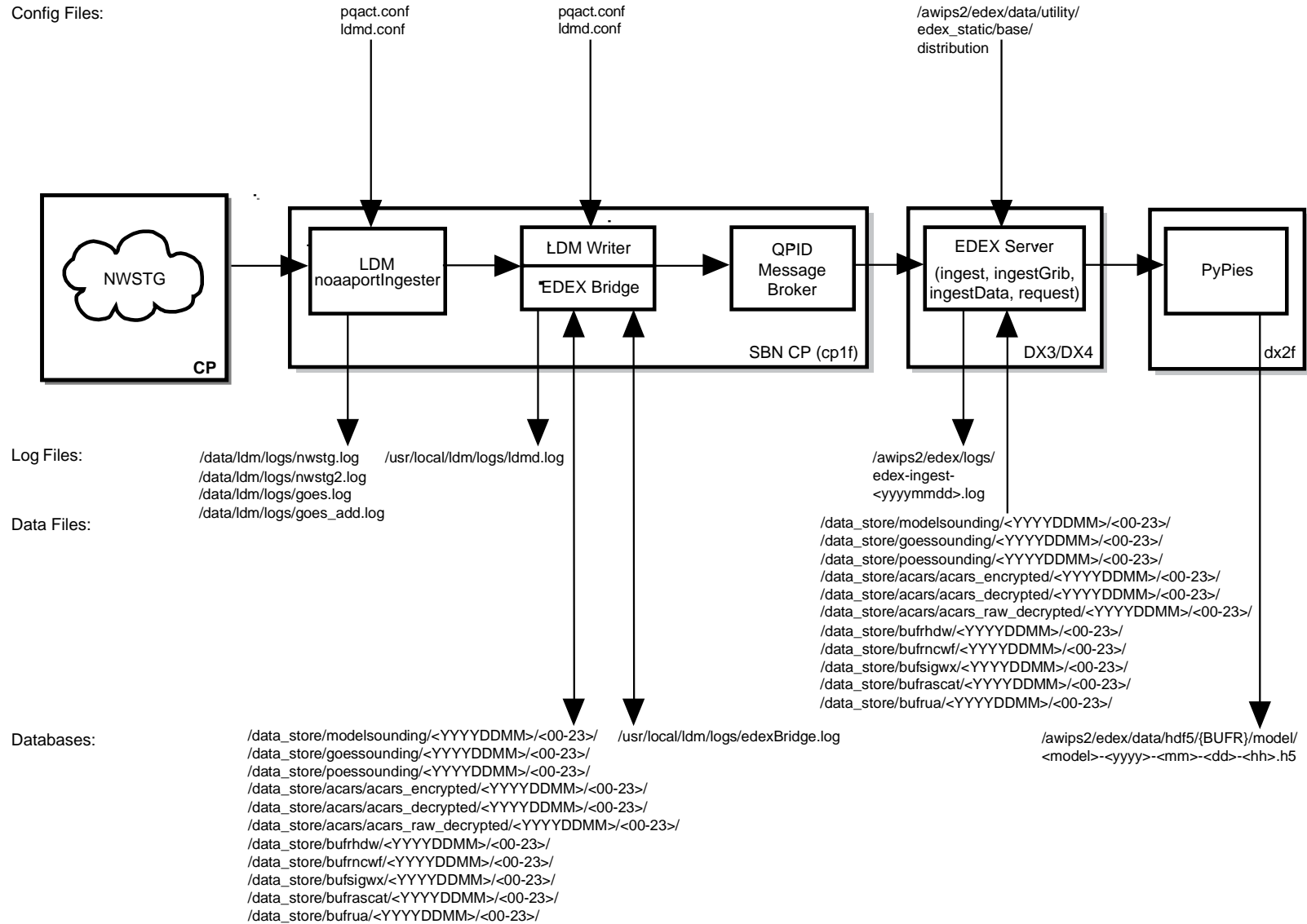

**Exhibit 6.6-1. Acquire and Ingest of BUFR Products**

**For POES soundings:**

```
/data_store/poessounding/{YYYYMMDD}
```

```
[root@dx3-tbdw data_store]# ls /data_store/poessounding/20130213
```

```
00 02 04 06 08 10 12 14 16 18 20 22
01 03 05 07 09 11 13 15 17 19 21 23
```

```
[root@dx3-tbdw data_store]# ls /data_store/poessounding/20130213/06
```

```
IUTX05_KNES_130641_289865564.bufr.2013021306
IUTX09_KNES_130628_289865519.bufr.2013021306
IUTX05_KNES_130642_289865633.bufr.2013021306
IUTX09_KNES_130648_289921154.bufr.2013021306
IUTX05_KNES_130643_289865570.bufr.2013021306
IUTX09_KNES_130649_289921063.bufr.2013021306
IUTX05_KNES_130644_289865573.bufr.2013021306
IUTX09_KNES_130650_289921029.bufr.2013021306
IUTX05_KNES_130645_289865527.bufr.2013021306
```

**For ACARS data:**

```
/data_store/acars/acars_encrypted
```

```
/data_store/acars/acars_decrypted
```

```
/data_store/acars/acars_raw_decrypted
```

```
[root@dx3-tbdw data_store]# ls /data_store/acars/acars_encrypted/20140113
```

```
01 01 02 03 04 05
```

```
[root@dx3-tbdw data_store]# ls /data_store/acars/acars_encrypted/20140113/05
```

```
IUAX02_KARP_130526_46666697.acars.2014011305
IUAX02_KARP_130526_46666716.acars.2014011305
IUAX02_KARP_130531_46668876.acars.2014011305
IUAX02_KARP_130531_466689cd33.acars.2014011305
IUAX02_KARP_130536_46670615.acars.2014011305
IUAX02_KARP_130536_46670653.acars.2014011305
IUAX02_KARP_130541_46672243.acars.2014011305
IUAX02_KARP_130541_46672293.acars.2014011305
IUAX02_KARP_130546_46673828.acars.2014011305
IUAX02_KARP_130546_46673850.acars.2014011305
IUAX02_KARP_130551_46677562.acars.2014011305
```

```
[root@dx3-tbdw data_store]# ls
  /data_store/acars/acars_decrypted/20140113/

01 01 02 03 04 05

[root@dx3-tbdw data_store]# ls
  /data_store/acars/acars_decrypted/20140113/05

IUAX02_KARP_130516_46662957.acars.2014011305.izZPrn
IUAX02_KARP_130521_46664772.acars.2014011305.ML8LOC
IUAX02_KARP_130521_46664829.acars.2014011305.a5Y89D
IUAX02_KARP_130521_46664875.acars.2014011305.C5dSmC
IUAX02_KARP_130526_46666652.acars.2014011305.NxgLQS
IUAX02_KARP_130526_46666697.acars.2014011305.stY2jT
IUAX02_KARP_130526_46666716.acars.2014011305.oFpNMT
IUAX02_KARP_130531_46668876.acars.2014011305.vvlUsi
IUAX02_KARP_130531_46668933.acars.2014011305.4rrtKA
IUAX02_KARP_130536_46670615.acars.2014011305.kRwZIQ
IUAX02_KARP_130536_46670653.acars.2014011305.l652gS
IUAX02_KARP_130541_46672243.acars.2014011305.h3puje
IUAX02_KARP_130541_46672293.acars.2014011305.BIVWFe
IUAX02_KARP_130546_46673828.acars.2014011305.lHKlfn
IUAX02_KARP_130546_46673850.acars.2014011305.C5PQY1
IUAX02_KARP_130551_46677562.acars.2014011305.zCA8a9
```

```
[root@dx3-tbdw data_store]# ls
  /data_store/acars/acars_raw_decrypted/20140113/

01 01 02 03 04 05
```

```
[root@dx3-tbdw data_store]# ls
  /data_store/acars/acars_raw_decrypted/20140113/05

IUAE01_EGRR_130537_46670333.bufr.2014011305
IUAE01_EGRR_130542_46671769.bufr.2014011305
IUAE01_EGRR_130542_46671770.bufr.2014011305
IUAE01_EGRR_130549_46673874.bufr.2014011305
IUAF01_EGRR_130520_46663561.bufr.2014011305
IUAH01_EGRR_130526_46665572.bufr.2014011305
IUAH01_EGRR_130526_46665589.bufr.2014011305
IUAH01_EGRR_130532_46668012.bufr.2014011305
IUAH01_EGRR_130539_46670788.bufr.2014011305
```

```
IUAH01_EGRR_130540_46671477.bufr.2014011305
IUAH01_EGRR_130545_46672729.bufr.2014011305
IUAS01_NZKL_130500_46658815.bufr.2014011305
IUAS01_NZKL_130500_46658817.bufr.2014011305
IUAS01_NZKL_130500_46658819.bufr.2014011305
IUAS01_NZKL_130500_46658823.bufr.2014011305
IUAS01_NZKL_130500_46658825.bufr.2014011305
IUAS01_NZKL_130500_46658827.bufr.2014011305
IUAS01_NZKL_130500_46658829.bufr.2014011305
IUAS02_NZKL_130500_46660085.bufr.2014011305
IUAS02_NZKL_130500_46660087.bufr.2014011305
```

**NOTE:** In ACARS, EGRR refers to UK, British Met Office, and PANC refers to NWS/NCEP Anchorage Alaska.

**For GOES High Density Wind (HDW) data:**

data\_store/bufrhdw/{YYYYMMDD}

```
[root@dx3-tbdw data_store]# ls /data_store/bufrhdw/20131030
```

```
00 02 05 07 09 12 14 17 19 21
01 03 06 08 11 13 15 18 20 23
```

```
[root@dx3-tbdw data_store]# ls /data_store/bufrhdw/20131013/15
```

```
JACX11_KNES_301500_57916828.bufr.2013103015
JHCX11_KNES_301521_57931609.bufr.2013103015
JCCX91_KNES_301550_57967612.bufr.2013103015
JECX11_KNES_301500_57916999.bufr.2013103015
JRCX71_KNES_130611_289863561.bufr.2013021306
```

data\_store/bufrmthdw/{YYYYMMDD}

```
[root@dx3-tbdw data_store]# ls /data_store/bufrmthdw/20140902
```

```
00 01 03 06 07 09 12 13 18
```

```
[root@dx3-tbdw data_store]# ls /data_store/bufrmthdw/20140902/13
```

```
JUTX31_KNES_021300_406608415.bufr.2014090213
JUTX53_KNES_021303_406615918.bufr.2014090213
JUTX31_KNES_021300_406608416.bufr.2014090213
JUTX53_KNES_021303_406615919.bufr.2014090213
JUTX31_KNES_021300_406608417.bufr.2014090213
```

```
JUTX53_KNES_021303_406615921.bufr.2014090213
JUTX31_KNES_021300_406608419.bufr.2014090213
JUTX53_KNES_021303_406615924.bufr.2014090213
JUTX31_KNES_021300_406608420.bufr.2014090213
JUTX53_KNES_021303_406615925.bufr.2014090213
JUTX31_KNES_021300_406608458.bufr.2014090213
JUTX53_KNES_021303_406615927.bufr.2014090213
JUTX31_KNES_021300_406608460.bufr.2014090213
JUTX53_KNES_021303_406615929.bufr.2014090213
```

**For newf (national convective weather forecast) data:**

data\_store/bufrncwf/{YYYYMMDD}

```
[root@dx3-tbdw data_store]# ls /data_store/bufrncwf/20130213
```

```
00 02 04 06 08 10 12 14 16 18 20 22
01 03 05 07 09 11 13 15 17 19 21 23
```

```
[root@dx3-tbdw data_store]# ls /data_store/bufrncwf/20130213/02
```

```
JSAT98_KKCI_130202_289400328.bufr.2013021302
JSAT98_KKCI_130207_289407604.bufr.2013021302
JSAT98_KKCI_130212_289416494.bufr.2013021302
JSAT98_KKCI_130217_289424875.bufr.2013021302
JSAT98_KKCI_130222_289433193.bufr.2013021302
JSAT98_KKCI_130227_289443476.bufr.2013021302
```

**For bufrsigwx data:**

data\_store/bufrsigwx/{YYYYMMDD}

```
[root@dx3-tbdw data_store]# ls /data_store/bufrsigwx/20130213
```

```
00 06 12 18
```

```
[root@dx3-tbdw data_store]# ls /data_store/bufrsigwx/20130213/12
```

```
JUBE99_KKCI_130600_140957852.bufr.2013021312
JUBE99_KKCI_130600_140957986.bufr.2013021312
JUCE00_KKCI_130600_140957855.bufr.2013021312
JUCE00_KKCI_130600_140957970.bufr.2013021312
JUFE00_KKCI_130600_140957882.bufr.2013021312
JUFE00_KKCI_130600_140957931.bufr.2013021312
JUJE00_KKCI_130600_140955935.bufr.2013021312
```



```

JUJE00_KKCI_130600_140955957.bufr.2013021312
JUME00_KKCI_130600_140955948.bufr.2013021312
JUME00_KKCI_130600_140955972.bufr.2013021312
JUNE00_KKCI_130600_140955947.bufr.2013021312
JUNE00_KKCI_130600_140955966.bufr.2013021312
JUOE00_KKCI_130600_140955932.bufr.2013021312
JUOE00_KKCI_130600_140955970.bufr.2013021312
JUTE00_KKCI_130600_140955997.bufr.2013021312
JUTE00_KKCI_130600_140956102.bufr.2013021312
JUTE97_KKCI_130600_140957854.bufr.2013021312
JUTE97_KKCI_130600_140957978.bufr.2013021312
JUVE00_KKCI_130600_140957887.bufr.2013021312
JUVE00_KKCI_130600_140957948.bufr.2013021312
JUWE96_KKCI_130600_140957859.bufr.2013021312
JUWE96_KKCI_130600_140957933.bufr.2013021312

```

**For bufrascat data:**

data\_store/bufrascat/{YYYYMMDD}

```
[root@dx3-tbdw data_store]# ls /data_store/bufrascat/20130213
```

```

00 02 04 06 08 10 12 14 16 18 20 22
01 03 05 07 09 11 13 15 17 19 21 23

```

```
[root@dx3-tbdw data_store]# ls /data_store/bufrascat/20130213/03
```

```

JSXX02_KNES_130257_289524095.bufr.2013021303
JSXX04_KNES_130257_289524066.bufr.2013021303
JSXX04_KNES_130257_289524077.bufr.2013021303
JSXX04_KNES_130257_289524079.bufr.2013021303
JSXX06_KNES_130257_289524050.bufr.2013021303
JSXX06_KNES_130257_289524065.bufr.2013021303
JSXX07_KNES_121938_46315441.bufr.2013021303

```

**For bufrua data:**

data\_store/bufrua/{YYYYMMDD}

```
[root@dx3-tbdw data_store]# ls /data_store/bufrua/20130213
```

```

00 02 04 06 08 12 14 16 19 21
01 03 05 07 11 13 15 18 20 23

```

```
[root@dx3-tbdw data_store]# ls /data_store/bufrua/20130312/02
IUSY41_KWBC_130200_289388924.bufr.2013021302
IUSY41_KWBC_130200_289388928.bufr.2013021302
IUSY42_KWBC_130235_289447526.bufr.2013021302
IUSY43_KWBC_130200_289388922.bufr.2013021302
IUSY43_KWBC_130205_289397852.bufr.2013021302
IUSY43_KWBC_130210_289406797.bufr.2013021302
IUSY43_KWBC_130245_289463217.bufr.2013021302
IUSY44_KWBC_130205_289397846.bufr.2013021302
IUSY44_KWBC_130210_289406799.bufr.2013021302
IUSY44_KWBC_130215_289414178.bufr.2013021302
IUSY44_KWBC_130235_289447532.bufr.2013021302
IUSY44_KWBC_130250_289471027.bufr.2013021302
IUSY48_KWBC_130205_289397859.bufr.2013021302
IUSZ51_KWBC_130255_289508743.bufr.2013021303
IUSZ53_KWBC_130200_289388983.bufr.2013021302
IUSZ53_KWBC_130205_289397843.bufr.2013021302
IUSZ54_KWBC_130200_289388973.bufr.2013021302
IUSZ54_KWBC_130215_289414171.bufr.2013021302
IUSZ58_KWBC_130200_289388990.bufr.2013021302
```

### 6.6.2 Decoding BUFR Data

Data decoding operations are performed on the EDEX (DX3/4) servers. Both EDEX servers share the load in the ingest process, which includes decoding the raw data, writing the decoded data into the Data Store, writing metadata to the database, and broadcasting a notification that the newly ingested data is available.

The processed data files are stored in /awips2/edex/data/hdf5 in the hdf5 format on the dx2f server. The processed BUFR data files are stored under /awips2/edex/data/hdf5

The basic directory structure for each model is /awips2/edex/data/hdf5/<model>

See Table 6.6.2-1 for directories and file names.

**Table 6.6.2-1. BUFR Data: Directories and File Names**

Directory	Filename
modelsounding	modelsounding-2013-02-13-00.h5
goessounding	goessounding-2013-02-13-08.h5
poessounding	poessounding-2013-02-13-08.h5
bufrhdw	hdw-2013-02-13-11.h5
bufrncwf	bufrncwf-2013-02-13-22.h5
bufrascat	ascat-2013-02-13-12.h5
bufrsigwx	SWBOTH: sigwxVTS-2013-02-13-18.h5 SWH: sigwxCAT-2013-02-13-06.h5, sigwxCLOUD-SWH-2013-02-13-00.h5, sigwxJETS-2013-02-13-06.h5, sigwxTROP-2013-02-13-18.h5 SWM: sigwxCLOUD-SWM-2013-02-13-18.h5, sigwxJETS-2013-02-13-06.h5, sigwxCAT-2013-02-13-00.h5, sigwxTROP-2013-02-13-18.h5
bufrua	bufrua-2011-10-25-06.h5
bufrmthdw	mthdw-2014-08-05-06.h5

The report codes in the DataURI for bufrua data support data queries that CAVE uses when it generates menus or creates certain data displays. The codes are actually somewhat arbitrary; selected by the AWIPS II developer, they are not documented outside the code, and are not particularly meaningful outside of the development environment. Table 6.6.2-2 provides the rough meaning of the codes.

**Table 6.6.2-2. Report Code Definitions**

Report Code	Meaning
2020	mandatory data from a level below the level having a pressure of 100MB
2021	significant wind data from a level below the level having a pressure of 100MB
2022	significant temperature data from a level below the level having a pressure of 100MB
2030	mandatory data from a level above the level having a pressure of 100MB
2031	significant wind data from a level above the level having a pressure of 100MB
2032	significant temperature data from a level above the level having a pressure of 100MB

### 6.6.3 Data Ingest and Logging of BUFR Products

#### On DX3/DX4:

```
[root@dx3-tbdw ~]# cd /awips2/edex/logs
```

After ingest of each data file is complete, the ingest endpoint prints a single line to the EDEX system log.

Log entries for each of the corresponding BUFR products are shown below.

#### For model sounding:

```
INFO 2016-06-12 02:50:11,875 [external.dropbox-4]
JmsPooledProducer: EDEX - Creating AMQ producer
Ingest.model sounding
```

```
INFO 2016-06-12 02:50:11,883 [Ingest.model sounding-1] Ingest:
EDEX: Ingest - model sounding::
/data_store/model sounding/20160612/02/JUSA41_KWNO_120200_33313862
5.bufr.2016061202 processed in: 0.0030 (sec) Latency: 0.0350
(sec)
```

```
INFO 2016-06-12 02:50:11,889 [Ingest.model sounding-1] Ingest:
EDEX: Ingest - model sounding::
/data_store/model sounding/20160612/02/JUSA41_KWNO_120200_33313862
8.bufr.2016061202 processed in: 0.0020 (sec) Latency: 0.0410
(sec)
```

### **For POES sounding:**

```
INFO 2016-06-12 03:33:41,684 [external.dropbox-2]
JmsPooledProducer: EDEX - Creating AMQ producer
Ingest.poessounding
```

```
INFO 2016-06-12 03:33:41,686 [Ingest.poessounding-1] Ingest:
EDEX: Ingest - poessounding::
/data_store/poessounding/20160612/03/IUTX09_KNES_120332_333275024
.bufr.2016061203 processed in: 0.0020 (sec) Latency: 0.0590 (sec)
```

### **For GOES sounding:**

```
INFO 2016-06-12 04:10:23,566 [Ingest.goessounding-1] Ingest:
EDEX: Ingest - goessounding::
/data_store/goessounding/20160612/04/JUTX07_KNES_120407_333373510
.bufr.2016061204 processed in: 0.0080 (sec) Latency: 0.1240 (sec)
```

### **For hdw:**

```
INFO 2013-02-13 03:25:29,935 [Ingest.bufrhdw-1] Ingest: EDEX:
Ingest - bufrhdw::
/data_store/bufrhdw/20130213/03/JJCX71_KNES_130322_289549021.bufr
.2013021303 processed in: 1.0010 (sec) Latency: 1.9010 (sec)
```

### **For mthdw:**

```
INFO 2014-09-02 00:11:30,193 [Ingest.bufrmthdw-1] Ingest: EDEX:
Ingest - bufrmthdw::
/data_store/bufrmthdw/20140902/00/JUTX21_KNES_020010_404816431.bu
fr.2014090200 processed in: 6.4900 (sec) Latency: 6.5010 (sec)
```

### **For ncwf:**

```
INFO 2013-02-13 03:52:18,234 [Ingest.ncwf-1] Ingest: EDEX:
Ingest - bufrncwf::
/data_store/bufrncwf/20130213/03/JSAT98_KKCI_130347_289597790.bu
fr.2013021303 processed in: 0.1490 (sec) Latency: 0.2410 (sec)
```

### **For bufrascats:**

```
INFO 2013-02-13 04:20:18,826 [Ingest.bufrascats-1] Ingest: EDEX:
Ingest - bufrascats::
```

```
/data_store/bufrascatscat/20130213/04/JSXX01_KNES_130417_289653851.bu
fr.2013021304 processed in: 0.5260 (sec) Latency: 0.5820 (sec)
```

### For bufrsigwx:

```
INFO 2013-02-13 06:47:21,792 [Ingest.bufrsigwx-1] Ingest: EDEX:
Ingest - bufrsigwx::
/data_store/bufrsigwx/20130213/00/JUFE00_KKCI_130000_140816142.bu
fr.2013021306 processed in: 0.0270 (sec) Latency: 0.0910 (sec)
```

### For bufrua:

```
INFO 2013-02-13 07:30:56,076 [Ingest.bufrua-1] Ingest: EDEX:
Ingest - bufrua::
/data_store/bufrua/20130213/07/IUSY44_KWBC_130730_289987232.bufr.
2013021307 processed in: 0.1480 (sec) Latency: 0.5500 (sec)
```

### For ACARS:

```
INFO 2014-01-13 03:28:37,738 [Ingest.acars-1] Ingest: EDEX:
Ingest - acars::
/data_store/acars/acars_raw_decrypted/20140113/03/IUAA01_CWAO_130
328_46589528.bufr.2014011303 processed in: 0.0080 (sec) Latency:
0.0700 (sec)
```

```
INFO 2014-01-13 03:32:27,105 [Ingest.acars-1] Ingest: EDEX:
Ingest - acars::
/data_store/acars/acars_decrypted/20140113/03/IUAX02_KARP_130331_
46591729.acars.2014011303.Gp0CcU processed in: 0.3520 (sec)
Latency: 0.3630 (sec)
```

```
INFO 2013-02-13 07:35:42,941 [Ingest.acars-1] Ingest: EDEX:
Ingest - acars::
/data_store/acars/20130213/07/IUAA01_EGRR_130747_289993974.bufr.2
013021307 processed in: 0.0410 (sec) Latency: 0.1130 (sec)
```

## 6.7 Decoding Synoptic Observation Data

Synoptic data, which is ingested from the SBN and handled by the SBN, is a specific, highly machine friendly, data format (i.e., easy for a machine to generate and decode). It also contains maritime/buoy data. Synoptic files are plain (ASCII) text files. A fairly large number of different synoptic types exist, but they are all surface observations.

Table 6.7-1 illustrates the surface obs type and data URI report type code.

**Table 6.7-1. Data URI Codes for Various Synoptic Observation Types**

Sfc Ob Type	Data URI Report Type Code
Synoptic Fixed Land	1001
Synoptic Mobile Land	1002
Synoptic Ship	1003
Synoptic CMAN	1004
Synoptic Moored Buoy	1005
Drifting Buoy	1006
Synoptic MAROB	1007

Here are some WMO headers for maritime data.

FZNT25 KNHC ddhhmm

FZNT26 KNHC ddhhmm

FZNT27 KNHC ddhhmm

**NOTE:** The Data URI for surface observations has the general form: /sfcobs/data time/report type code/correction indicator/station ID/latitude/longitude.

See Exhibit 6.7-1 for the flow of the acquisition and ingest of synoptic products.

### 6.7.1 Data Archive and File Naming Conventions for Synoptic Data

#### For sfcobs data:

data\_store/synoptic/{YYYYMMDD}

```
[root@dx3-tbdw text]# ls /data_store/synoptic/20150523
```

```
00 02 04 06 08 10 12 14 16 18 20 22
01 03 05 07 09 11 13 15 17 19 21 23
```

```
[root@dx3-tbdw text]# ls /data_store/synoptic/20150523/00
```

```
SMCS01_MROC_230000_12282105.2015052223
SMMX01_KWBC_230000_12289777.2015052300
SMMX01_MXBA_230000_12289882.2015052300
SMCS01_MROC_230000_12282138.2015052223
SMMX01_KWBC_230000_12289783.2015052300
SMMX02_KWBC_230000_12289790.2015052300
SMCS01_MROC_230000_12288646.2015052300
SMMX01_MXBA_230000_12288641.2015052300
SMUS41_KGYX_230001_12288368.201505230
```

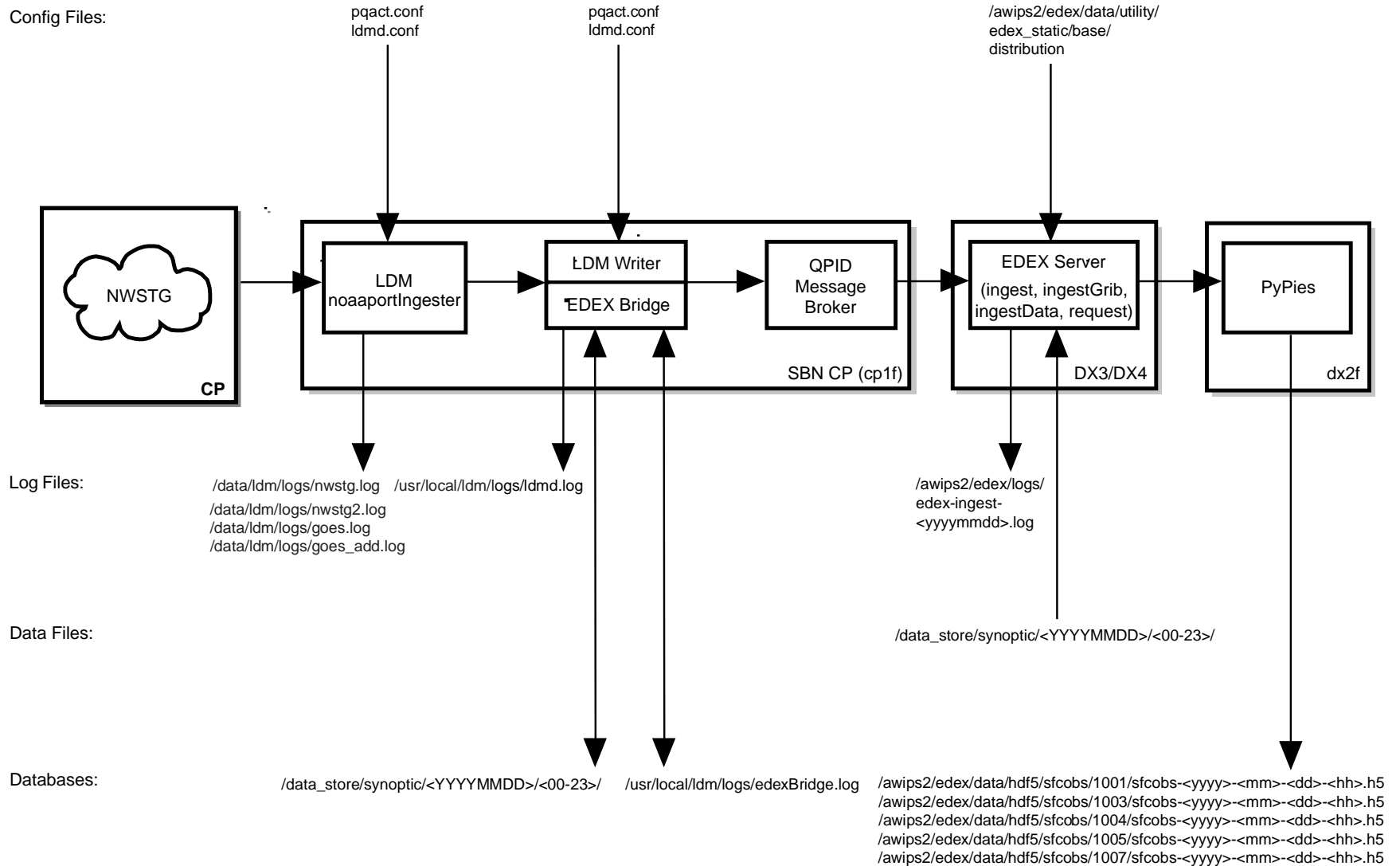

Exhibit 6.7-1. Acquire and Ingest of Synoptic Products

### 6.7.2 Decoding Synoptic Data

The Ingested Synoptic Data files are stored in the Data Store.

The hdf5 basic directory structure is /awips2/edex/data/hdf5/sfcobs/

```
[root@dx2-tbdw sfcobs]# ls /awips2/edex/data/hdf5/sfcobs/
```

```
1001 1003 1004 1005 1007
```

```
[root@dx2-tbdw sfcobs]# ls /awips2/edex/data/hdf5/sfcobs/1006
```

```
sfcobs-2013-02-05-18.h5  sfcobs-2013-02-12-00.h5  sfcobs-2013-02-13-21.h5
```

```
sfcobs-2013-02-06-00.h5  sfcobs-2013-02-12-03.h5  sfcobs-2013-02-13-22.h5
```

```
sfcobs-2013-02-06-06.h5  sfcobs-2013-02-12-06.h5  sfcobs-2013-02-13-23.h5
```

```
sfcobs-2013-02-06-12.h5  sfcobs-2013-02-12-09.h5  sfcobs-2013-02-14-00.h5
```

```
sfcobs-2013-02-06-18.h5  sfcobs-2013-02-12-12.h5  sfcobs-2013-02-14-01.h5
```

```
sfcobs-2013-02-07-00.h5  sfcobs-2013-02-12-15.h5  sfcobs-2013-02-14-02.h5
```

```
sfcobs-2013-02-07-06.h5  sfcobs-2013-02-12-17.h5
```

### 6.7.3 Data Ingest and Logging of Synoptic Products

All data ingest operations are logged in the EDEX logs on the EDEX (DX3/4) server. In a standard installation, the EDEX logs are located in /awips2/edex/logs. This directory contains several log files; the files starting “edex-” are the EDEX logs.

#### On DX3/DX4:

```
[root@dx3-tbdw ~]# cd /awips2/edex/logs
```

```
[root@dx3-tbdw logs]# date +%F
```

```
2013-02-13
```

```
[root@dx3-tbdw logs]# ls edex-*20130213*
```

```
edex-ingest-20130213.log
edex-ingestDat-20130213.log
edex-ingest-gen_areal_ffg-20130213.log
edex-ingest-gen_areal_qpe-20130213.log
edex-ingestGrib-20130213.log
edex-ingest-purge-20130213.log
edex-ingest-radar-20130213.log
edex-ingest-satellite-20130213.log
edex-ingest-shef-20130213.log
```



```

edex-ingest-shef-performance-20130213.log
edex-ingest-smartInit-20130213.log
edex-ingest-text-20130213.log
edex-ingest-unrecognized-files-20130213.log
edex-request-20130213.log
edex-request-productSrvRequest-20130213.log
edex-request-thriftSrv-20130213.log
edex-ingest-archive-20130213.log
edex-ingest-activeTableChange-20130213.log
edex-ingestGrib-performance-20130213.log
edex-ingest-performance-20130213.log
edex-request-performance-20130213.log
edex-ingest-gen_areal_qpe-20130213.log
edex-request-hibernate-20130213.log
edex-ingest-hibernate-20130213.log
edex-ingest-ohd-20130213.log
edex-request-textdbSrvRequest-20130213.log
edex-ingestDat-performance-20130213.log
edex-ingest-sportlma-20130213.log
edex-ingestGrib-hibernate-20130213.log

```

```
[root@dx3-tbdw logs]# tail -f edex-ingest-20130213.log
```

After ingest of each data file is complete, the ingest endpoint prints a single line to the EDEX system log. The format of the log entry is

**INFO** <<date-time>> [thread] Ingest: <<type>>:: <<file name>> <<statistics>>

```

INFO 2013-05-20 00:12:19,820 [Ingest.sfcobs-1] Ingest: EDEX:
Ingest - sfcobs::
/data_store/synoptic/20130520/00/SMCN21_CWAO_200000_126419892.201
3052000 processed in: 0.2340 (sec) Latency: 0.2430 (sec)

```

## 6.8 *Decoding Special Sensor Microwave Imager*

SSM/I data is received via the SBN.

See Exhibit 6.8-1 for the flow of the acquisition and ingest of SSM/I products.

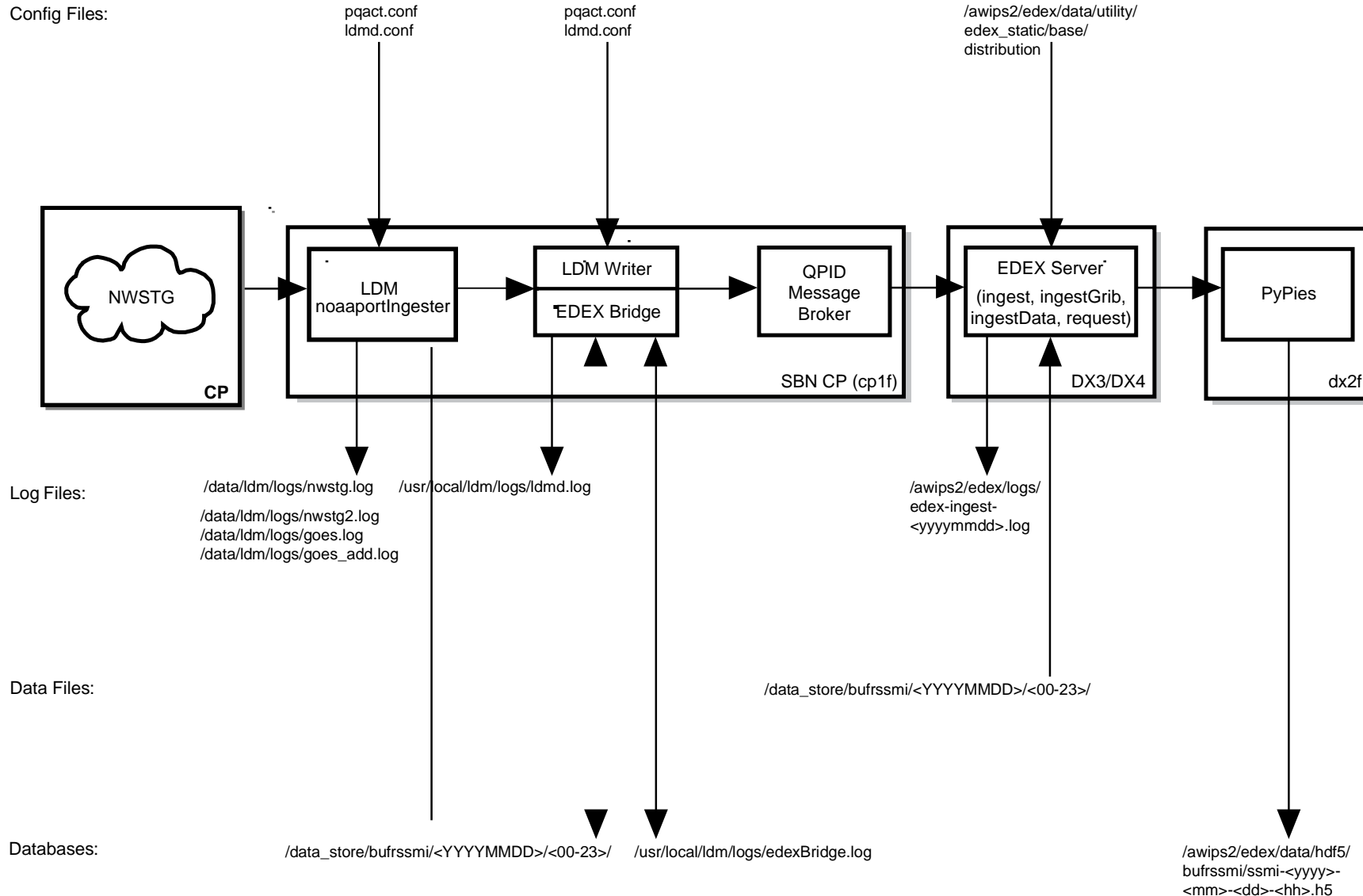

Exhibit 6.8-1. Acquire and Ingest of SSM/I Products

### 6.8.1 Data Archive and File Naming Conventions for SSM/I Data

SSM/I data ingested via the SBN is written to the /data\_store/bufrssmi/hh, where hh is the SSM/I data hour as obtained from the WMO header that accompanies the data.

Under the data type folder, i.e., bufrssmi, you will find a set of directories representing the various hours these products were issued. For SSM/I data, under /data\_store/bufrssmi/{YYYYMMDD}/ you will find folders ranging from 00 through 23. For example, if you change to /data\_store/20131030//19, you will find all observations issued between 19z and 20z.

Typical example is shown below.

```
ISXA22_KWNO_191900_45633071.bufr.2013103019
ISXA22_KWNO_191900_45633112.bufr.2013103019
ISXA22_KWNO_191900_45633127.bufr.2013103019
```

### 6.8.2 Decoding SSM/I Data

```
[root@dx2-tbdw ssmi]# ls /awips2/edex/data/hdf5/bufrssmi/
ssmi-2013-05-02-13.h5  ssmi-2014-01-04-22.h5  ssmi-2014-01-09-22.h5
ssmi-2013-05-02-14.h5  ssmi-2014-01-04-23.h5  ssmi-2014-01-09-23.h5
ssmi-2013-12-31-01.h5  ssmi-2014-01-05-00.h5  ssmi-2014-01-10-00.h5
ssmi-2013-12-31-23.h5  ssmi-2014-01-05-22.h5  ssmi-2014-01-10-22.h5
ssmi-2014-01-01-01.h5  ssmi-2014-01-05-23.h5  ssmi-2014-01-11-00.h5
ssmi-2014-01-01-23.h5  ssmi-2014-01-06-00.h5  ssmi-2014-01-11-22.h5
ssmi-2014-01-02-00.h5  ssmi-2014-01-06-22.h5  ssmi-2014-01-11-23.h5
```

### 6.8.3 Data Ingest and Logging of SSM/I Products

All data ingest operations are logged in the EDEX logs on the EDEX (DX3/4) server. In a standard installation, the EDEX logs are located in /awips2/edex/logs. This directory contains several log files; the files starting “edex-” are the EDEX logs.

The log file is a plain ASCII text file and can be viewed using any text viewing utility such as more, less, view, tail, etc.

To get a general view of processing, open a terminal session to the server and enter the following commands:

#### On DX3:

```
TYPE:      cd /awips2/edex/logs
```

```
TYPE:      ls edex-*
```

This will list the edex log files.

```
TYPE:      tail -f edex-ingest-20131030.log
```

#### **On DX4:**

```
TYPE:      cd /awips2/edex/logs
```

```
TYPE:      ls edex-*
```

This will list all the edex log files.

```
TYPE:      tail -f edex-ingest-20131030.log
```

After ingest of each data file is complete, the ingest endpoint prints a single line to the EDEX system log. The format of the log entry is

```
INFO <<date-time>> [thread] Ingest: <<type>>:: <<file name>> <<statistics>>
```

A log entry will be as follows.

```
INFO 2013-10-30 01:31:06,765 [Ingest.bufrssmi-1] Ingest: EDEX:
Ingest - bufrssmi::
/data_store/bufrssmi/20131030/01/ISXA23_KWNO_130100_46510926.bufr
.2013103001 processed in: 0.0160 (sec) Latency: 3.8630 (sec)
```

## **6.9 convSIGMET Data**

### **6.9.1 Data Archive and File Naming Conventions for convSIGMET Data**

convSIGMET data ingested via the SBN is written to the /data\_store/text/{hh}, where hh is the convsigmet hour as obtained from the WMO header that accompanies the data. Nonconvsigmet and intlsigmet are also stored in the same format.

```
[root@dx3-tbdw data_store]# ls /data_store/convsigmet/<YYYYMMDD>
```

```
[root@dx3-tbdw data_store]# ls /data_store/convsigmet/20130213
```

```
00 02 04 06 08 10 12 14 16 18 21 23
01 03 05 07 09 11 13 15 17 20 22
```

```
[root@dx3-tbdw data_store]# ls /data_store/convsigmet/20130213/02
```

```
WSUS31_KKCI_130255_289482017.2013021302
WSUS32_KKCI_130255_289482283.2013021302
WSUS33_KKCI_130255_289481955.2013021302
```

### 6.9.2 *Decoding convSIGMET Data*

convSIGMET data is decoded by the convsigmet data decoder, which is part of the EDEX Ingest process running on the DX3/4 cluster.

**NOTE:** The decoders for nonconvsigmet and intlsigmet are **nonconvsigmet** and the **intlsigmet** decoders respectively. For the database, the tables used for **nonconvsigmet** data are **nonconvsigmet** and **nonconvsigmet\_location**. For **intlsigmet**, the tables used are **intlsigmet** and **intlsigmet\_location**. As with **convsigmet**, all tables are part of the AWIPS II **metadata** database.

### 6.9.3 *Data Ingest and Logging of ConvSIGMET Products*

All data ingest operations are logged in the EDEX logs on the EDEX (DX3/4) server. In a standard installation, the EDEX logs are located in /awips2/edex/logs. This directory contains several log files; the files starting “edex-” are the EDEX logs.

Open a terminal session to the server and enter the following commands:

#### **On DX3/DX4:**

```
[root@dx3-tbdw ~]# cd /awips2/edex/logs
[root@dx3-tbdw logs]# date +%F
2013-02-13
[root@dx3-tbdw logs]# ls edex-*20130213*
edex-ingest-20130213.log
edex-ingestDat-20130213.log
edex-ingest-gen_areal_ffg-20130213.log
edex-ingest-gen_areal_qpe-20130213.log
edex-ingestGrib-20130213.log
edex-ingest-purge-20130213.log
edex-ingest-radar-20130213.log
edex-ingest-satellite-20130213.log
edex-ingest-shef-20130213.log
edex-ingest-shef-performance-20130213.log
edex-ingest-smartInit-20130213.log
edex-ingest-text-20130213.log
edex-ingest-unrecognized-files-20130213.log
edex-request-20130213.log
edex-request-productSrvRequest-20130213.log
edex-request-thriftSrv-20130213.log
edex-ingest-archive-20130213.log
edex-ingest-activeTableChange-20130213.log
edex-ingestGrib-performance-20130213.log
edex-ingest-performance-20130213.log
edex-request-performance-20130213.log
```

```

edex-ingest-gen_areal_qpe-20130213.log
edex-request-hibernate-20130213.log
edex-ingest-hibernate-20130213.log
edex-ingest-ohd-20130213.log
edex-request-textdbSrvRequest-20130213.log
edex-ingestDat-performance-20130213.log
edex-ingest-sportlma-20130213.log
edex-ingestGrib-hibernate-20130213.log

```

To monitor the ingest stream, a little understanding of the logging strategy used by EDEX is required. After ingest of each data file is complete, the ingest endpoint prints a single line to the EDEX system log. The format of the log entry is

**INFO** <<date-time>> [thread] Ingest: <<type>>:: <<file name>> <<statistics>>

A log entry will be as follows.

```

INFO 2013-02-13 14:56:02,850 [Ingest.convSIGMET-1] Ingest: EDEX:
Ingest - convSIGMET::
/data_store/convSIGMET/20130213/14/WSUS32_KKCI_131455_290744857.
2013021314 processed in: 0.0070 (sec) Latency: 0.3520 (sec)

```

A log entry for intlSIGMET will be as follows.

```

INFO 2013-02-13 14:57:37,026 [Ingest.convSIGMET-1] Ingest: EDEX:
Ingest - intlSIGMET::
/data_store/wwa/20130213/15/WSNT02_KKCI_131500_290749300.20130213
14 processed in: 0.0260 (sec) Latency: 0.1270 (sec)

```

**NOTE:** The nonconvSIGMET will follow the same data logging and ingest operation as is illustrated above for convSIGMET and intlSIGMET.

### 6.10 Tracing NWSTG (TAF) Products Using the Sequence Number

In general, to trace an SBN product, you must first identify the product's WMO header. The following example traces a TAF through the system. The general pattern is *FTUS43 XXXX ddhmm*. The specific WMO header being traced in the example is *FTUS43 KEAX 141500*.

**NOTE:** In the normal AWIPS II system, CP1 and CP2 are clustered as are PX 1/2 and DX 1/2. In this example, it is assumed that CP1, DX1, and DX2 are the active members of each cluster.

1. Verify that the product was received on CPSBN (CP1).

Verify that the product was received by logging on to CP1 and examining the LDM log. To facilitate the examination, `grep` is used to limit the output. The LDM logs are stored in the logs directory under the LDM home directory. The active LDM logs are `goes.log`, `nwstg2.log`, `nwstg.log`, `oconus.log` and `goes_add.log`. The `grep` command

filters FTUS43 by site EAX and displays the most current entry by piping the output to tail -1.

The steps to follow:

```
[root@cpsbn1-tbdw logs]# /usr/local/ldm/logs
[root@cpsbn1-tbdw logs]# ls -l *.log
-rw-rw---- 1 root fxalpha 1475996 Feb 14 03:28 goes.log
-rw-rw---- 1 root fxalpha 609001 Feb 14 03:26 ldmd.log
-rw-rw---- 1 root fxalpha 88872724 Feb 14 03:27 nwstg2.log
-rw-rw---- 1 root fxalpha 346572421 Feb 14 03:29 nwstg.log
-rw-rw---- 1 root fxalpha 72442342 Feb 14 03:29 oconus.log
-rw----- 1 root root 4406926 Feb 14 02:57 polarsat.log
-rw----- 1 root root 4406926 Feb 14 02:43 goes_add.log
[root@cpsbn1-tbdw logs]# grep -l "FTUS43" *.log
nwstg.log
[root@cpsbn1-tbdw logs]# grep "FTUS43 KEAX" nwstg.log | tail -1
Feb 13 05:26:01 cpsbn1-box readnoaaport[5005] NOTE: FTUS43
KEAX 220000 /pTAFSTJ inserted [cat 1 type 4 ccb 2/0 seq
460087807 size 133]
```

The sequence number (in this case 460087807) is a sequence number that is uniquely assigned to this product. It may be used to track the product as it is ingested and stored.

2. Verify that the product was received on the CPSBN cluster and written to the data archive.

We verify that the product was received on the cp1f LDM and written to the data archive by logging onto cp1f and checking two locations: the LDM log and the data archive. In both of these cases, the key to finding the product the sequence number discovered in step (1).

The steps to follow:

Login to cpsbn1f,

```
[root@cpsbn1-tbdw ~]# cd ~ldm/logs
[root@cpsbn1-tbdw logs]# ls
ldmd.log ldmd.log.2 ldmd.log.4 ldmd.log.6 scour.log
ldmd.log.1 ldmd.log.3 ldmd.log.5 ldmd.log.7
[root@cpsbn1-tbdw logs]# grep 460087807 ldmd.log
Feb 13 00:00:19 dx2-tbdw pqact[22217] NOTE: Filed in
```

```
"/data_store/text/13/02/FTUS43_KEAX_220000_460087807.20130213"
:      12420 20130213000017.724 IDS|DDPLUS 460087807 FTUS43
KEAX 220000 CCA
```

```
[root@dx2-tbdw data_store]# find /data_store/text/ | grep 460087807

/data_store/text/13/02/FTUS43_KEAX_220000_460087807.20130213
```

### 3. Verify that the product has been ingested.

Generally, we can verify that the product has been ingested by examining the EDEX Ingest process logs and looking for an entry identifying the file ingest.

This is complicated somewhat by the fact that the product may have been ingested on either DX3 or DX4. There is no way to predict the correct server, so we simply check them both. If the product has been ingested, it will appear in the log on either DX3 or DX4. The basic process is to grep for the sequence number in the EDEX Ingest process logs.

The steps to follow on DX3:

```
[root@dx2-tbdw data_store]# ssh dx3
[root@dx3-tbdw ~]# cd /awips2/edex/logs
[root@dx3-tbdw logs]# date +%F
2013-02-13
[root@dx3-tbdw logs]# ls edex*20130213*
edex-ingest-20130213.log
edex-ingestDat-20130213.log
edex-ingest-gen_areal_ffg-20130213.log
edex-ingest-gen_areal_qpe-20130213.log
edex-ingestGrib-20130213.log
edex-ingest-purge-20130213.log
edex-ingest-radar-20130213.log
edex-ingest-satellite-20130213.log
edex-ingest-shef-20130213.log
edex-ingest-shef-performance-20130213.log
edex-ingest-smartInit-20130213.log
edex-ingest-text-20130213.log
edex-ingest-unrecognized-files-20130213.log
edex-request-20130213.log
edex-request-productSrvRequest-20130213.log
edex-request-thriftSrv-20130213.log
edex-ingest-archive-20130213.log
edex-ingest-activeTableChange-20130213.log
edex-ingestGrib-performance-20130213.log
edex-ingest-performance-20130213.log
edex-request-performance-20130213.log
```



```

edex-ingest-gen_areal_qpe-20130213.log
edex-request-hibernate-20130213.log
edex-ingest-hibernate-20130213.log
edex-ingest-ohd-20130213.log
edex-request-textdbSrvRequest-20130213.log
edex-ingestDat-performance-20130213.log
edex-ingest-sportlma-20130213.log
edex-ingestGrib-hibernate-20130213.log

```

```
[root@dx3-tbdw logs]# grep 460087807 edex-ingest-20130213.log
```

```

INFO 2013-02-13 00:07:16,288 [Ingest.taf-1] Ingest: EDEX: Ingest -
taf::
/data_store/forecast/20130213/00/FTUS80_KWBC_200006_460087807.2013021
300 processed in: 0.0070 (sec) Latency: 0.0350 (sec)

```

### 6.11 Add NCEPs GFS-DNG (for Guam) to AWIPS

Over the last two years EMC developed the GFS downscaling processing to the point where it is ready for operational dissemination into AWIPS. The GFS-based DNG products will be provided by NCEP in GRIB2 format, via the SBN. The WMO headers for these products will be [L/M]\*G\*\*\* KWBT. The GFS-based DNG products will be produced for the 0000, 0600, 1200 and 1800 UTC model cycles with output every 3 hours from 0 to 192 hours after model initialization time. The Guam DNG products are horizontally interpolated from the 27 km GFS native grid to the 2.5 km mercator NDFD grid for Guam. This is the so-called grid 199, whose grid specification is at: <http://www.nco.ncep.noaa.gov/pmb/docs/on388/tableb.html#GRID199>

Vertical interpolation to the high resolution terrain is performed at NCEP using Smartinit. The following elements/parameters will be produced by NCEP and should be handled by AWIPS: temperature at surface level dew point at surface level specific humidity at surface level u - wind at surface level v - wind at surface level wind gust at surface level pressure at surface level height at surface level land mask at surface level total cloud cover at surface level height at lowest level wet bulb visibility at surface level wind direction at planetary boundary wind speed at planetary boundary relative humidity at planetary boundary geopotential height at planetary boundary best (4 layer) lifted index at surface level total precipitation at surface level categorical rain at surface level maximum temperature at surface level minimum temperature at surface level maximum relative humidity at surface level maximum relative humidity at surface level AWIPS should be enhanced to handle the SBN ingest, GRIB2 decode, store, display, and GFE ingest.

### 6.12 Decrypting Lightning Data

Some lightning data must be decrypted as part of the data ingestion process. This requires additional configuration of keystore files. The main lightning decryption configuration is stored in the /usr/local/ldm/BinLightningAESKey.properties file. This file contains the following properties:

Property: binlightning.AESKeystore

Value: Fully qualified path to a keystore that contains keys for decrypting lightning products from GLD or NLDN. The default value is /usr/local/ldm/binLightningAESKeystore.jce.

Property: binlightning.AESKeystorePassword

Value: Password for keystore referenced by binlightning.AESKeystore property.

Property: total.lightning.AESKeystore

Value: Fully qualified path to a keystore that contains keys for decrypting lightning products from Earth Networks Total Lightning Network (ENTLN). The default value is /usr/local/ldm/totalLightningAESKeystore.jce.

Property: total.lightning.AESKeystorePassword

Value: Password for keystore referenced by total.lightning.AESKeystore property.

Property: total.lightning.cipherAlgorithm

Value: Cipher algorithm used to encrypt ENTLN data. Default value is AES/CBC/NoPadding.

Property: total.lightning.initializationVectorFile

Value: Fully qualified path to a binary initialization vector file for ENTLN data decryption. This is required when the total lightning cipher algorithm uses an initialization vector. The default value is /usr/local/ldm/totalLightning.iv.

## **Chapter 7**

# **Ingest of Radar Data**

## Chapter 7. Ingest of Radar Data

### Table of Contents

	<i>Page</i>
7.1 Overview .....	1
7.2 Radar Ingest Operation .....	5
7.2.1 SBN Radar Ingest Operation.....	5
7.2.2 ORPG Radar Ingest Operation.....	5
7.3 Data Archiving.....	6
7.3.1 Radar Archive Structure.....	8
7.3.1.1 Available SBN Radar Site Identifiers .....	9
7.3.1.2 Available ORPG Radar Site Identifiers.....	10
7.3.1.3 Available SBN Product Categories .....	11
7.3.1.4 Available ORPG Product Categories .....	11
7.3.2 EDEX Ingest Radar Data Logging.....	12
7.3.2.1 Radar Server Logs .....	13
7.3.2.2 Configuring Radar Server Logging .....	14
7.3.3 SBN Radar Configuration Files .....	15
7.3.3.1 SBN Radar Configuration Files – LDM.....	15
7.3.3.2 SBN Radar Configuration Files – PQACT .....	15
7.3.3.3 SBN Radar Configuration Files – EDEX Data Distribution Files .....	16
7.3.4 ORPG Radar Configuration Files .....	17
7.3.4.1 ORPG Radar Configuration Files – Radar Server.....	17
7.3.4.2 ORPG Radar Configuration Files – EDEX Data Distribution files .....	19
7.3.5 Storing Decoded SBN Radar Data.....	19
7.3.5.1 AWIPS II Metadata Database – Radar Metadata .....	20
7.3.5.2 AWIPS II Data Store – Radar Products .....	20
7.3.6 Audible Radar-Alerting.....	21
7.4 WAN/SBN Radar Product Distribution from Site to NCF.....	24
7.5 RPS list .....	28
7.6 Two-Way Communication.....	32
7.7 Central Collection Cron Schedule .....	34

### List of Exhibits

Exhibit 7.1-1. Radar Ingest Data Flow .....	2
Exhibit 7.2.1-1. Acquire and Ingest of Radar Products .....	7
Exhibit 7.3.6-1. Alert Visualization Configuration dialog .....	21
Exhibit 7.3.6-2. Alert Visualization Configuration Sources & Priorities .....	22
Exhibit 7.3.6-3. Alert Visualization Configuration Sources & Priorities Audio .....	23

Exhibit 7.3.6-4. Alert Visualization Configuration Sources & Priorities Audio File..... 23  
Exhibit 7.3.6-5. Alert Visualization Configuration List ..... 24  
Exhibit 7.5-1. RPS List Editor ..... 29  
Exhibit 7.5-2. RPS List Editor View Menu – Select List ..... 30  
Exhibit 7.5-3. RPS List Editor View Menu List ..... 31  
Exhibit 7.5-3. RPS List Editor View Menu List Edit ..... 31  
Exhibit 7.6-1. Sending Environmental Data ..... 33  
Exhibit 7.6-2. Sending Radar Applications ..... 34

**List of Tables**

Table 7.4-1. WSR-88D Products on AWIPS ..... 25

## 7.1 Overview

The AWIPS WSR-88D/TDWR radar data ingest is responsible for providing products to be sent and receiving centrally collected radar products over the SBN; requesting/receiving data from one or more associated ORPGs/SPGs; sending Radar Precipitation Bias Table to the ORPG; and making the data available to the AWIPS workstations. More specifically, the radar ingest system is responsible for initiating and maintaining connections with multiple ORPGs/SPGs, forwarding data requests from the workstations to the ORPGs/SPGs, receiving and processing data and status messages from the ORPGs/SPGs, and forwarding status messages to the workstations.

Two additional EDEX “tasks” are involved here. They are both are part of the EDEX RPG Environmental Data Service (rpgenvdata), and are triggered by Quartz timers. They are:

Send Environmental Data	Timer: Fires every hour on the hour
send Bias Table	Timer: Fires 26 and 46 minutes after each hour

Both tasks are managed by the EDEX Ingest Process on DX3 and DX4. The triggering mechanism is “clustered quartz”; this means that the event fires on both DX3 and DX4, but a locking mechanism is employed so that only one of the servers performs the work. Messages, status, error, etc., are logged to the EDEX Ingest process log (edex-ingest-yyyyymmdd.log); search for RPGEnvData. See Section 7.5 for detailed explanation.

SBN data is delivered via the Local Data Manager (LDM) on CPSBN (cp1f), and the locally collected radar data is delivered via the Radar Server on DX1/2.

Radar Ingest Data Flow is illustrated in the Exhibit 7.1-1. As shown in the exhibit, the data flow is a 12-step process. Descriptions of each step of the process follow.

1. Radar Data are received from two sources: The Radar Server on the DX1/2 cluster obtains radar data from the ORPG/SPG; and radar data obtained from the SBN is received from the LDM noaaportIngestor on the CP1/2 cluster. **Note:** RCM in the Exhibit 7.1-1 refers to Radar Coded Message, a specific kind of product generated by the RPG.
  - a. The Radar Server and the LDM noaaportIngestor write the product to a file on the Data Archive on NAS [NAS2]. (Refer to Section 7.1.)
  - b. The Radar Server and LDM post their messages containing product information to the QPID Message
  - c. The LDM writer instance uses the EDEX Bridge to post a message containing product information to the QPID Message Broker. The product information is the WMO header and the path to the product file.

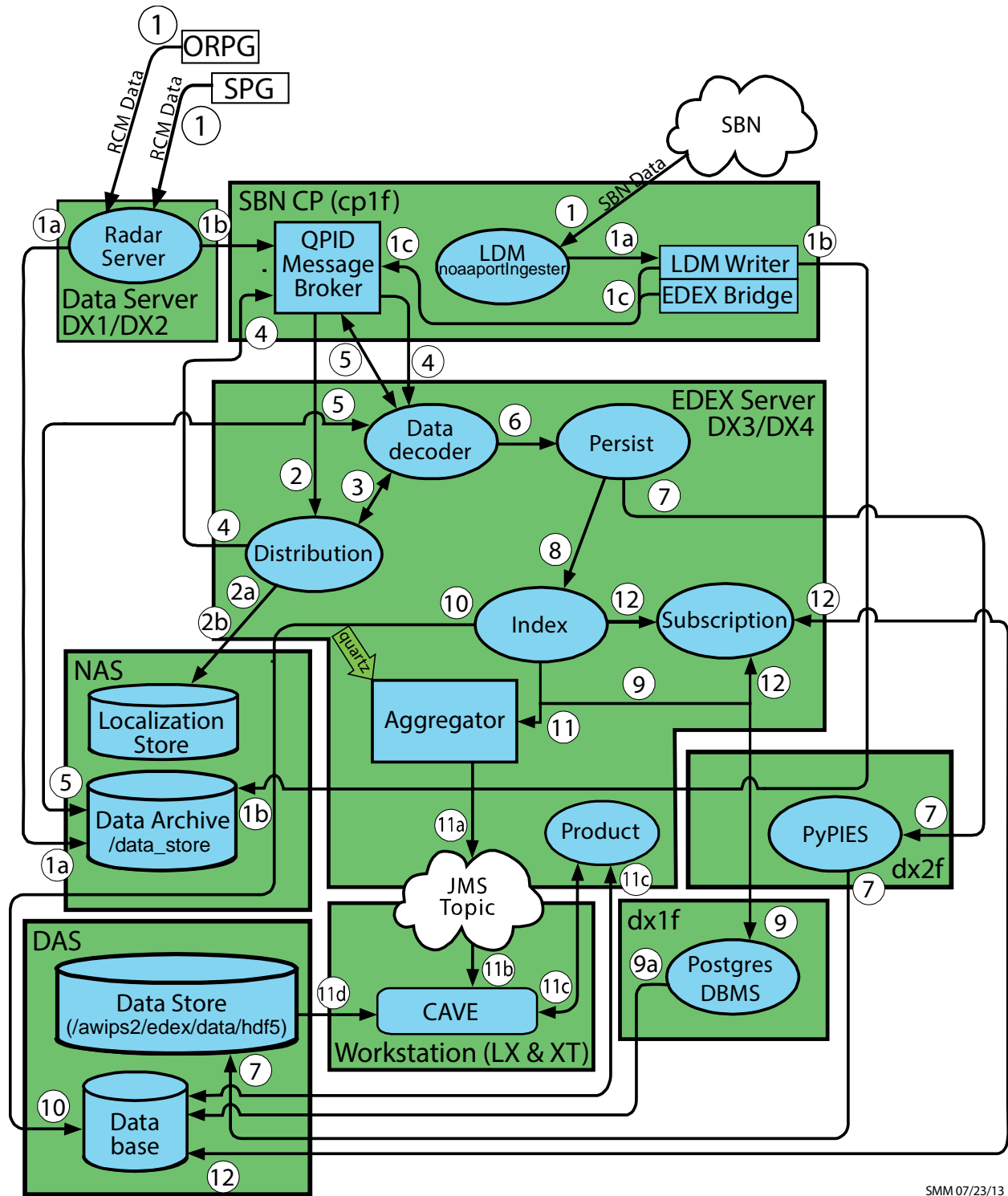

SMM 07/23/13

Exhibit 7.1-1. Radar Ingest Data Flow

2. The EDEX Distribution endpoint obtains the WMO (World Meteorological Organization) header for the product file identified by the message. The WMO header is matched against data distribution mappings contained in the data distribution directory to determine product routing. (The WMO header is usually included in the message; if it is not, the Distribution service uses the product file name from the message to determine routing.)

**NOTE:** The files in the data distribution directory are XML (eXtensible Markup Language) files that contain regular expressions which match WMO headers with the appropriate data decoder plug-in.

- a. At EDEX startup, the EDEX Distribution endpoint reads the Data Distribution files from the Data Distribution directory in the Localization Store. It uses the contents of these files to generate the routing table used to determine data routing. The Data Distribution directory is located at `/awips2/edex/data/utility/edex_static/base/distribution`.
  - b. The EDEX Distribution endpoint monitors the Data Distribution directory; when a file in that directory is modified, it rereads that file and rebuilds its routing table.
3. The EDEX Distribution Service determines the Data Decoder Plug-In registered to handle the data in the product file.
  4. The EDEX Distribution Service forwards the message to the appropriate Data Decoder Plug-In via the QPID Message Broker.
  5. The EDEX Data Decoder Service on the EDEX (DX) cluster pulls the message from the QPID Message broker. The Data Decoder Service reads the file pointed to by the message, decodes the data, and determines the appropriate metadata.
  6. The decoded data and metadata are sent to the EDEX Persist endpoint.
  7. The EDEX Persist endpoint sends the data to PyPIES and PyPies writes the data to the EDEX data store in HDF5 format.
  8. The EDEX Persist endpoint sends the metadata obtained to the EDEX Index endpoint.
  9. The EDEX Index endpoint sends the metadata to the PostgreSQL DBMS. The PostgreSQL DBMS writes the metadata to the database.
  10. The index endpoint does not merely get the dataURI. It also persists the data object to the database. Persistence to the database is executed via a plug-in defined data access object. If the data access object does not override the persistence behavior, then a default persistence strategy is used. The default strategy for persisting data to the database is to first check to see if the data received already exists. If it already exists, then persistence to the database is not attempted for that data. If the data is unique, then it is persisted to the database.



11. (Client notification) The Data URI is forwarded to the EDEX URI Aggregator.

Every 5 seconds the aggregated Data URIs are sent to the JMS Alert Topic.

CAVE monitors the JMS Alert Topic to obtain a list of available data. CAVE determines if it should render the available data.

CAVE retrieves metadata from the EDEX server via a product query sent to the EDEX Thrift endpoint.

CAVE retrieves product data from the EDEX server by accessing the EDEX data store's HDF5 files and CAVE renders the data, updating its display as appropriate.

12. (Subscription) The Data URI is forwarded to the EDEX Subscription endpoint.

The EDEX Subscription endpoint checks the active subscription list to determine if a subscription has been registered for the product.

If no subscription has been registered for the product, no further action is taken.

The EDEX Subscription endpoint obtains the script information from the database.

The EDEX Subscription endpoint obtains a micro-engine to execute the script. The micro-engine executes the subscription script for the product.

The Radar Server manages the following types of requests (please note that the forecaster interaction is via the CAVE Radar menu):

- Routine Product Set (RPS) list
- One-Time Request (OTR)
- VCP Change Request
  
- Radar Multiple Request (RMR)
- Centrally collected radar products
- Radar Precipitation Bias Table.

The **RPS list** contains the products to be sent routinely to the workstation and the products to be centrally collected for transmission over the SBN. The list is sent to the ORPG/SPG on system start-up, when the radar mode changes, or when a forecaster at the workstation modifies one of the adaption RPS lists and sends it to the ORPG/SPG. An RPS list sent to an ORPG/SPG contains both a national and a local component if a site is identified as the office responsible for the national collection and distribution of radar data. National products take precedence over local products.

The **OTR** enables a forecaster at the workstation to request that a product be sent on a one-time basis only. When requesting data from a dedicated radar, the forecaster can also request that the product be sent for more than one volume scan. The request is terminated when it has been completed.

A VCP change request enables a forecaster at the workstation to modify the current VCP setting, enable/disable AVSET, and change the number of SAILS cuts being requested. The forecaster also has the option of forcing a volume scan restart. This option is only available to sites explicitly authorized to make VCP configuration changes in the ORPG configuration. RadarServer receives product code 12 at startup to indicate that the site has permissions to make any changes. The message also relays the current settings for VCP and SAILS.

The RMR enables a forecaster at the workstation to request a single product (like an OTR) or a package of products, schedule requests for products at a specified frequency, and/or request products from any number of dedicated and dial-out ORPGs/SPGs.<sup>1</sup>

The NCF sends centrally collected radar products to all AWIPS sites over the SBN. Specified sites are tasked to collect and send certain products to the NCF via the WAN.

**Radar Precipitation Bias Tables** are available for transmission from AWIPS to an interested receiving ORPG site.

The new Radar Server takes the place of the following AWIPS I processes.

- RadarServer
- DialServer
- ORPGCommsMgr
- ORPGReqMgr.

## 7.2 *Radar Ingest Operation*

### 7.2.1 *SBN Radar Ingest Operation*

SBN data is delivered via the Local Data Manager (LDM) on CPSBN (cp1f), and the locally collected radar data is delivered via the Radar Server on DX1/2. SBN radar product ingest is performed by the EDEX Ingest processes on DX3 and DX4. EDEX operation is controlled by the edex\_camel service script located in /etc/init.d on DX3 and DX4.

### 7.2.2 *ORPG Radar Ingest Operation*

As illustrated in Exhibit 7.2.1-1, ORPG radar product ingest is controlled by the AWIPS II Radar Server, which is installed on the DX1/2 cluster. The Radar Server is controlled by the edex\_rcm service script located in /etc/init.d on DX1 and DX2.

---

<sup>1</sup> For information on how to perform on OTR, see Section 8.3 of the AWIPS II CAVE-D2D User's Manual (UM). Also see UM Section 8.1 for information on configuring an alert request and UM Section 8.4 for information on how to perform an RMR.

### 7.3 *Data Archiving*

Radar products are written to the Data Archive in three separate locations:

- SBN radar products are written to /data\_store/radar/<YYYYMMDD>/<HH>/XXXX where XXXX is an uppercase, four- or three-character radar site identifier (customizable via the LDM).
- ORPG radar products are written to /data\_store/radar/xxxx where xxxx is the lowercase, four-character radar site identifier.

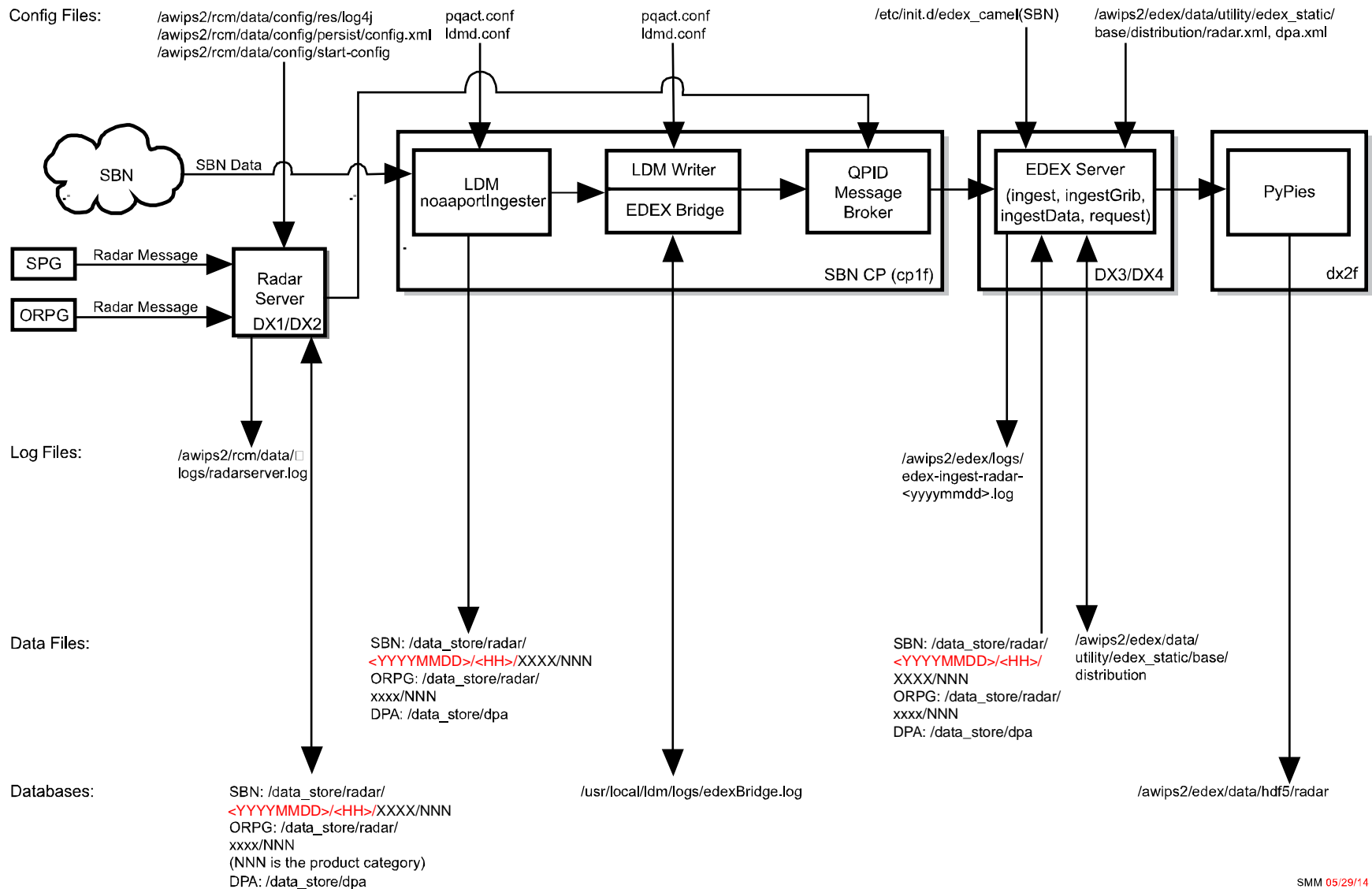

Exhibit 7.2.1-1. Acquire and Ingest of Radar Products

- Digital Precipitation Array (DPA) data is potentially stored in both the SBN and the ORPG data sections. At this point, the SBN stores a subset of the radar data it receives into /data\_store/dpa. This is the “DPA” data, which is used by the DPA process in EDEX. Because the DPA has been Rehosted (rather than rewritten), the options for placing the data were limited. In essence, the path (below /data\_store) to the data was built into the software being rehosted. DPA products are written to /data\_store/dpa and /data\_store/radar.

The raw data is stored in the Data Archive. The physical directory (/data\_store) is on the NAS. All the hosts mount the volume off NAS. [**Note:** The data\_store volume is moved off the DAS (dx2 direct mount; export via nfs to all hosts) and onto NAS.]

### 7.3.1 Radar Archive Structure

#### SBN Radar Products

The general structure of the SBN radar product archive is determined by the header information on the radar products. For radar data, the archive structure is

```
/data_store/radar/<YYYYMMDD>/<HH>/KXXX/NNN
```

and the files are named:

```
<RadarName>_NNN_<Radar_Volume_Scan_Time>_SDUS51_XXXX_seque  
nce.rad.<YYYYMMDDHH>
```

Where,

NNN ⇔ the product category

Radar\_Volume\_Scan\_Time: This is taken from the WMO heading. **Note:** In some products (GSMs), it is the message time.

SDUSii ⇔ product identifier

XXXX ⇔ product originator (transmitting wfo identifier – this is customizable via the LDM)

YYYYMMDDHH ⇔ the product time stamp

LDM assigns the sequence number. Its design minimizes the likelihood of file overwrites.

#### ORPG Radar Products

ORPG Radar products are written to the Data Archive in directories under /data\_store/radar. Each site that the Radar Server is configured for has a single directory at this level. (The directory’s name is the radar site identifier in lower case. Technically, however, it does not have to be lower case; it could be in either case.) Each site directory contains several subdirectories; each of these subdirectories is the mnemonic of the products in the directory. Under each product mnemonic, products are organized into

product-dependent structures. Subdirectories are generally self-explanatory. Three common directory structure patterns in the Radar Server Data Store are

```
/data_store/radar/<site>/<mnemonic>/<elevation>/<resolution>/<level>
```

Where `site` is the radar site and `mnemonic` is the product mnemonic.

```
E.g., /data_store/radar/tbwi/Z/elev19_5/res0_15/level256
/data_store/radar/<site>/<mnemonic>/<elevation>/<resolution>/<az>/<level>
```

```
E.g., data_store/radar/kgrr/Z/elev1_5/res0_25/az0_5/level256/
/data_store/radar/<site>/<mnemonic>/<layer>/<resolution>/<level>
```

```
E.g., /data_store/radar/tbwi/CZ/layer0/res1/level16
```

The exact directory structure used by the Radar Server is determined by the Radar Server software and is unchanged from AWIPS 1 and it's preserved primarily to support FSI.

### DPA Products

DPA Products are stored in the same way as other SBN or ORPG products.

#### 7.3.1.1 Available SBN Radar Site Identifiers

The list of potential radar sites available in the Data Archive depends on the configuration of the LDM and the EDEX Distribution Service. It is possible to query the Data Archive to determine available site identifiers. This query is performed using a command line script; the script can run on any workstation with access to the Data Archive.

Enter the following command in a console window or x-term:

```
TYPE:      cd /data_store/radar/<YYYYMMDD>/<HH>
```

```
TYPE:      ls | grep -P "[A-Z]"
```

```
KBGM
```

```
KABX
```

```
KAMA
```

```
KBLX
```

```
KCYS
```

```
KDAL
```

```
KDDC
```

```
KDFW
```

```
KDFX
```

```
KDYX
```

```
KEWX
```

```
KFDX
```

KFSX  
KFWS  
KGJX  
KGLD  
KGRK  
KICH  
KICT  
KICX  
KINX  
KIWA  
KLBB  
KLNK  
KMTX  
KPHX  
KPUX  
KSGF  
KSHV  
KSJT  
KSLC  
KSRX  
KTLX  
KTUL  
KTWX  
KUEX  
KVNK  
KYUX

**NOTE:** This procedure provides a list of radar sites from which Radar Data has been received over the SBN. It does not provide a list of current sites or current data.

### 7.3.1.2 Available ORPG Radar Site Identifiers

The list of ORPG radar sites available for the Radar Server depends on the configuration of the Radar Server and the EDEX Distribution Service. It is possible to query the Data Archive to determine available site identifiers. This query is performed using a command line script that may be performed from any workstation with access to the Data Archive.

Enter the following commands in a console window or X-Term:

```
TYPE:      cd /data_store/radar
TYPE:      ls | grep -P "^[a-z]{4}$" > ~/radar-sites.txt
TYPE:      sort ~/radar-sites.txt > ~/sorted-radar-sites.txt
```

```
TYPE:    cat ~/sorted-radar-sites.txt | tr [:cntrl:] ' : '
           > ~/radar-sites.txt
```

```
TYPE:    cat ~/radar-sites.txt ; echo
           koax
```

### 7.3.1.3 Available SBN Product Categories

The list of Product Categories available in the Data Archive will depend on the configuration of the LDM and the EDEX distribution server. It may also vary from radar site to radar site. It is possible to query the Data Archive to get a rough list of available product categories. This query is performed using a command line script; the script may be performed from any workstation with access to the Data Archive.

Enter the following commands in a console window or X-Term:

```
TYPE:    cd /data_store/radar/<YYYYMMDD>/<HH>/KXXX
```

```
TYPE:    echo $( for i in $(ls | grep -E "[A-Z]{4}$"); do
                 ls "$i"; done | sort | uniq)      (all on one line)
```

```
DAA DPR DU3 NOC NOQ NOV N1H N1Q N2C N2Q N3C N3Q NCR NVW
DHR DSD DVL N0H N0R N0X N1K N1S N2H N2S N3H N3S NET OHA
DOD DSP EET N0K N0S N0Z N1M N1U N2K N2U N3K N3U NTP PTA
DPA DTA HHC N0M N0U N1C N1P N1X N2M N2X N3M N3X NVL
```

**NOTE:** This procedure provides a list of product categories for Radar Data received over the SBN. It does not provide a list of current product categories or current data.

### 7.3.1.4 Available ORPG Product Categories

Product categories for a specific site may be determined by listing that site's directory in /data\_store/radar. To determine product categories available regardless of site, use the following script:

```
TYPE:    cd /data_store/radar
```

```
TYPE:    echo $( for i in $(ls | grep -E "[a-z]{4}$"); do
                 ls "$i"; done | sort | uniq)      (all on one line)
```

```
AAP APR CFC CZ DHR DMD DPA DUA DVL EET ET GSM HI LRM MD OHP OSD OSW PRR
PTL RCM RSS SO SPD SRM SS SSD SSW STI STP SW THP TRU TVS ULR V VIL VWP Z
```



**NOTE:** This procedure provides a list of product categories for Radar Data received over the SBN. It does not provide a list of current product categories or current data.

### 7.3.2 EDEX Ingest Radar Data Logging

Radar Ingest processing follows the same general strategy for logging as the remaining data decoders; both routine messages and error messages are logged to the EDEX process logs. The process logs are located in /awips2/edex/logs on each of the EDEX servers, DX3 and DX4. The logs to examine are the EDEX Ingest process log and the EDEX Radar Ingest process log.

**Note:** The EDEX Ingest process logs contain startup messages and most other messages, including errors, for the EDEX processes. The EDEX Radar Ingest process log contains messages relating to a radar type. These include both status messages and error messages.

To monitor basic EDEX ingest, log into either DX3 or DX4 and change the directory to /awips2/edex/logs.

**TYPE:**        `tail -f edex-ingest-yyyyymmdd.log`

where yyyyymmdd is the date stamp of the current log file.

To monitor messages specific to Radar Product ingest, log into either DX3 or DX4 and change directory to /awips2/edex/logs.

**TYPE:**        `tail -f edex-ingest-radar-yyyyymmdd.log`

where yyyyymmdd is the date stamp of the current log file.

The LDM writer uses patterns to determine where to write data files, including the path and file name. A typical entry is something like this and it is created by the config\_awips2.sh script.

```

NNEXRAD ^(SDUS[234578].|NXUS6.)
(K|P|T)(OUN|AMA|FWD|DDC|SJT|GLD|GID|LZK|LUB|EWX|SHV|SGF|TOP|TSA|IC
T)(...)(...)(...) /p(...)(...)
      FILE      -overwrite -log -close -edex
/data_store/radar/(\4:yyyy)(\4:mm)\4/\5/\2\8/\7/\2\8_\7_\4\5\6-
\1_\2\3_(seq).rad.%Y%m%d%H

```

Log entry similar is shown below.

```

INFO 2014-05-19 00:00:11,320 [Ingest.Radar-1] Ingest: EDEX:
Ingest - radar-sbn::
/data_store/radar/20140518/23/KBGM/N2C/KBGM_N2C_182337-
SDUS81_KBGM_43526953.rad.2014051900 processed in: 0.0510
(sec) Latency: 2.1520 (sec)

```

The number before the ".rad" (43526953 in this case) is set by the LDM and can be traced from EDEX. These sequence numbers (product identifiers) can be traced to the LDM logs on the cpsbn2 (goes.log, nwstg.log, etc.) in /data/ldm/logs.

**NOTE:** For additional information on monitoring EDEX and EDEX based ingest operations, see Chapter 25.

### 7.3.2.1 Radar Server Logs

The Radar Server also maintains its own logging. Radar Server logs are located in `/awips2/rcm/data/logs`. The current Radar Server log is `radarserver.log`. In normal conditions, the Radar Server creates a new log file daily and retains up to 3 old logs. Old logs are named `radarserver.log.yyyy-mm-dd`.

To monitor basic Radar Server operation, log onto the active member of the DX1/2 cluster and change directory to `/awips2/rcm/data/logs`.

**TYPE:**            `tail -f radarserver.log`.

The basic structure of the Radar Server is the same as the EDEX logging. Routine messages fit one of two patterns:

**INFO** <time-stamp> [thread] RadarServer: Stored <message>

```
INFO 00:00:04,914 [TCM Read kbox #2] RadarServer: kbox:
message code=99 size=68294 elev=0.9 sequence=17216 vs=2014-
05-19 00:01:44 #35
```

**INFO** <time-stamp> [thread] RadarServer: <site>: <message>

```
INFO 00:00:10,200 [TCM Read kbox #2] RadarServer: Stored
message in
/data_store/radar/kbox/V/elev0_9/res0_15/level256/kbox.99.20
140519_0001
```

These messages will normally occur in pairs. These patterns can be used to perform a quick status check on the Radar Server.

To monitor product arrival for a specific site, log onto the active member of the DX1/2 cluster and change directory to `/awips2/rcm/data/logs`. Once in that directory,

**TYPE:**            `tail -f radarserver.log | grep "RadarServer: <site>:"`

(replace <site> with the site identifier)

To monitor Radar Server writes, log onto the active member of the DX1/2 cluster and change directory to `/awips2/rcm/data/logs`. Once in that directory,

**TYPE:**            `tail -f radarserver.log | grep "RadarServer: Stored"`

### 7.3.2.2 Configuring Radar Server Logging

Radar Server logging is controlled by a file called `log4j.properties` which is located in `/awips2/rcm/data/config/res` on each server in the DX1/2 cluster.

Unlike EDEX configuration files, this directory is not shared between the servers, so any desired changes will need to be made on both servers. The baseline version of `log4j.properties` for the Radar Server contains the following entries.

```
log4j.rootLogger=INFO, rolling
log4j.logger.RadarServer=INFO, rolling
log4j.additivity.RadarServer=false
log4j.appender.console=org.apache.log4j.ConsoleAppender
log4j.appender.console.layout=org.apache.log4j.PatternLayout
log4j.appender.console.layout.ConversionPattern=%-5p %d [%t] %c{1}: %m%n
log4j.appender.rolling=com.raytheon.rcm.server.DailyPurgingRollingFileAppender
log4j.appender.rolling.layout=org.apache.log4j.PatternLayout
log4j.appender.rolling.layout.ConversionPattern=%-5p %d{HH:mm:ss,SSS} [%t] %c{1}: %m%n
log4j.appender.rolling.File=${com.raytheon.rcm.logDir}/radarserver.log
log4j.appender.rolling.DatePattern='.'yyyy-MM-dd
log4j.appender.rolling.MaxFiles=3
```

#### Default log4j.properties for Radar Server

**NOTE:** Take extreme care in modifying this file; an error will cause logging and perhaps operational problems in the Radar Server. The only line that should be modified is the final one on the file: **log4j.appender.rolling.MaxFiles=3**

This line specifies the number of old logs to retain. Change the 3 to the desired number of old files. Then restart the Radar Server for the changes to take effect

The last line in the `log4j.properties` file specifies the number of old log files to keep. Log files are rolled daily, that is, a new log file is opened each day. Normally, as installed, three log files are retained. This means the current log file plus the previous two are retained. This also handles file purging – when the radar server is started, and each day thereafter, excess log files are deleted. For example, to retain a total of six old logs, change the final entry to "`log4j.appender.rolling.MaxFiles=6`".

**NOTE:** The only reason to change `log4j.properties` (a configuration file) is to change the number of old logs being retained. This file applies only to the AWIPS II Radar Server, the application that bridges AWIPS II EDEX Ingest and the ORPG. It is located at `/awips2/rcm/data/config/res` on DX1 and DX2. Configuration files located in `/awips2/edex/conf` on both DX 3 and DX4 control all other EDEX process logging. These files are `log4j.xml` and `log4j-ingest.xml`. Any changes related to logging of other data types must be made in these files. Two caveats: 1) Each server (DX3/DX4) holds a copy of each of these logs. Changes made to one of these files on one server must be propagated to the other. The changes are read only at EDEX startup. 2) These are XML files, which can be sensitive to errors. Edits made to these files can cause malformed XML, which could cause logging issues. It does not appear to cause EDEX to quit, but there are startup issues, and, depending on where the XML error occurs, logging can be affected. Most changes to the EDEX logging strategy need to be made to one or both of these files, but this is not recommended.

### 7.3.3 SBN Radar Configuration Files

There are two types of Radar Configuration Files: 1) the LDM PQACT files; and 2) EDEX Distribution Service files.

#### 7.3.3.1 SBN Radar Configuration Files – LDM

LDM server runs only on the SBN CP. It ingests everything from the SBN.

LDM behavior is controlled by the `pqact.conf` file, and the patterns are matched against **pqact.conf**. LDM writes the product to `data_store` and posts a QPID message.

- **pqact.conf** controls how data sent to an instance of LDM is handled. This includes the data types to be handled and the location of the raw data archive.

**NOTE:** Modifying `pqact.conf` will have a severe impact on the data flow.

#### 7.3.3.2 SBN Radar Configuration Files – PQACT

Radar data flow is archived into two separate areas: radar products and Digital Precipitation Array (DPA) products. In general, LDM writes radar products to directories under `/data_store/radar` and DPA products under `/data_store/dpa`.

This is an example of what is being generated by `config_awips2.sh`:

```

NNEXRAD ^(SDUS[234578].|NXUS6.)
(K|P|T)(OUN|AMA|FWD|DDC|SJT|GLD|GID|LZK|LUB|EWX|SHV|SGF|TOP|TSA|ICT)
(..)(..)(..) /p(...)(...)

```

```
FILE -overwrite -log -close -edex
/data_store/radar/(\4:yyyy)(\4:mm)\4\5\2\8\7\2\8_\7_\4\5\6-
\1_\2\3_(seq).rad.%Y%m%d%H
```

The first part, NNEXRAD, is the FEEDTYPE.

The Regular Expression describes any product starting with SDUS and follows with any number between 2 and 8 OR starting with NXUS6.

The () store that string into the variable \1, which can be used when storing to physical disk.

(K|P|T) matches either a K, P or T and stores that to the variable \2 .

(OUN|AMA|FWD|DDC|SJT|GLD|GID|LZK|LUB|EWX|SHV|SGF|TOP|TSA|ICT) matches any of those site IDs and stores it to variable \3 .

(.)(.)(.) matches the next 6 characters of any type and stores them in pairs to \4, \5, and \6 respectively.

/p matches the exact string /p

(...)(...) matches the next 6 characters of any type and stores them in trios to \7 and \8 .

#### Product:

```
NEXRAD3 56424268 SDUS51 KLWX 211529 /pTZLDCA !nids/
```

#### Storage Location:

```
/data_store/radar/<YYYYMMDD>/<HH>/KDCA/TZL/1529_KDCA_TZL_56424268
.rad
```

**For DPA products**, the pattern is nearly identical. In this case, only DPA products are matched, so the NNN entry is hard coded as DPA.

### 7.3.3.3 SBN Radar Configuration Files – EDEX Data Distribution Files

In addition to the configuration files that control the LDM, the EDEX ingest subsystem uses a set of configuration files to determine which decoder(s) will handle the data. These files are initially installed with EDEX; once EDEX has been started, they are located in the AWIPS II localization store in /awips2/edex/data/utility/edex\_static/base/distribution. (Recall that to access the localization store, you log onto DX3.)

The files in /awips2/edex/data/utility/edex\_static/base/distribution contain acceptance patterns for each decoder. As a general rule, the files are named <data type>.xml. For radar data, the file is radar.xml; for DPA data, the file is dpa.xml. Here is a sample version of the radar.xml file.

```
<requestPatterns >
  <regex>^SDUS[234578]. .*</regex>
```

```
<regex>^RadarServer.*</regex>
</requestPatterns>
```

Here is a sample version of the dpa.xml file.

```
<requestPatterns xmlns:ns2="group">
  <regex>^SDUS8. . . . _DPA*</regex>
  <regex>^SDUS5. .*</regex>
  <regex>^.{4}.81.*</regex>
  <regex>^RadarServer.*.81</regex>
```

SDUS\* entries support the SBN radar data; RadarServer entries support the ORPG ingest of local radars. Each <regex/> tag contains a Perl 5 style regular expression, which is matched against the WMO header of a data file; if the pattern matches, the decoder can handle the data in the file.

Both radar.xml and dpa.xml may be edited to change data acceptance rules for the Distribution Service. This is normally performed as part of the site localization.

**NOTE:** Use care in editing these files; malformed XML can result in a failure of the EDEX Ingest process to start.

### 7.3.4 ORPG Radar Configuration Files

There are two types of configuration files: Radar Server; and EDEX Data Distribution.

#### 7.3.4.1 ORPG Radar Configuration Files – Radar Server

The radar data flow is controlled via the RCM configuration files on DX1/2. The configuration files are located in the /awips2/rcm/data/config directory tree. Basic Radar Server operation is controlled by two configuration files:

- **Start-config.** Contains basic information required for Radar Server operation. It is initialized by the AWIPS II installer; it should not be modified.
- **config.xml.** Contains configuration information defining data flow. It is located in /awips2/rcm/data/config/persist. It may be modified to change the list of radars being processed by the Radar Server. ORPG Radar Configuration Files – config.xml.

**config.xml** provides basic information the Radar Server uses to communicate with the rest of AWIPS. The basic format of config.xml is shown in the sample file on the following page; it shows two radars being accessed via Radar Server – koax and ktlx.

```

<?xml version="1.0" encoding="UTF-8" standalone="yes"?>
<config>
  <pupID>614</pupID>
  <regionCode>3</regionCode>
  <wmoSiteID>KOAX</wmoSiteID>
  <collectionEnabled>true</collectionEnabled>
  <tdwrCollectionLimited>true</tdwrCollectionLimited>
  <decompressProducts>true</decompressProducts>
  <edexEndpoint>/awips2/edex/data/sbn/radar</edexEndpoint>
  <endpointConfig>
    <archiveRoot>/data_store/radar</archiveRoot>

  <connectionURL>amqp://guest:guest@/edex?brokerlist='tcp://cplf:5672'</connectionURL>
    <prefixPathWithRadar>>false</prefixPathWithRadar>
    <topic>radarserver.dropbox</topic>
  </endpointConfig>
  <radars>
    <radar>
      <radarID>kbox</radarID>
      <nexradID>323</nexradID>
      <enabled>true</enabled>
      <dedicated>true</dedicated>
      <collectionEnabled>true</collectionEnabled>
    <sendEnvironmentalData>true</sendEnvironmentalData>
    <linkType>TCP_WAN</linkType>
    <links>
      <link>
        <dedicated>true</dedicated>
        <!-- linkAddress>165.92.24.75:4490</linkAddress -->
        <linkAddress>165.92.21.33:4490</linkAddress>
        <linkIndex>2</linkIndex>
        <linkType>TCP_WAN</linkType>
        <maxRpsListSize>150</maxRpsListSize>
        <tcmPassword>passwd</tcmPassword>
      </link>
    </links>
    <productAvailabilityFieldUsable>true</productAvailabilityFieldUsable>
  </radar>
  <radar>
    <radarID>tbwi</radarID>
    <nexradID>3005</nexradID>
    <enabled>>false</enabled>
    <dedicated>true</dedicated>
    <collectionEnabled>false</collectionEnabled>
    <sendEnvironmentalData>true</sendEnvironmentalData>
    <linkType>TCP_WAN</linkType>
    <links>
      <link>
        <dedicated>true</dedicated>
        <linkAddress>165.92.21.77:4488</linkAddress>
        <linkIndex>2</linkIndex>
        <linkType>TCP_WAN</linkType>
        <maxRpsListSize>-1</maxRpsListSize>
        <portPassword>TCPP</portPassword>
        <tcmPassword>passwd</tcmPassword>
        <userPassword>PRCWIP</userPassword>
      </link>
    </links>
    <productAvailabilityFieldUsable>true</productAvailabilityFieldUsable>
  </radar>
</radars>
</config>

```

### Sample Radar Server config.xml

### 7.3.4.2 ORPG Radar Configuration Files – EDEX Data Distribution files

The EDEX ingest subsystem uses a set of configuration files to determine which decoder(s) will handle data. These files are initially installed with EDEX; once EDEX has been started, they are located in the AWIPS II localization store in `/awips2/edex/data/utility/edex_static/base/distribution`. (Recall that to access the localization store, you log onto DX3.)

The files in `/awips2/edex/data/utility/edex_static/base/distribution` contain acceptance patterns for each decoder. As a general rule, the files are named `<data type>.xml`. For data from the Radar Server, the file is `radar.xml`.

Typical contents of `radar.xml` are:

```
<requestPatterns xmlns:ns2="group">
  <regex>^SDUS[234578]. KABR.*</regex>
  <regex>^SDUS[234578]. KCYS.*</regex>
  <regex>^SDUS[234578]. KDMX.*</regex>
  <regex>^SDUS[234578]. KGLD.*</regex>
  <regex>^SDUS[234578]. KGID.*</regex>
  <regex>^SDUS[234578]. KEAX.*</regex>
  <regex>^SDUS[234578]. KARX.*</regex>
  <regex>^SDUS[234578]. KMPX.*</regex>
  <regex>^SDUS[234578]. KLBF.*</regex>
  <regex>^SDUS[234578]. KDVN.*</regex>
  <regex>^SDUS[234578]. KUNR.*</regex>
  <regex>^SDUS[234578]. KFSD.*</regex>
  <regex>^SDUS[234578]. KTOP.*</regex>
  <regex>^SDUS[234578]. PHFO.*</regex>
  <regex>^SDUS[234578]. PGUM.*</regex>
  <regex>^koax.*</regex>
  <regex>^RadarServer.*</regex>
</requestPatterns>
```

For the Radar Server, the key is the final `<regex/>` tag; this specifies that a message containing a header starting with “RadarServer” is to be routed to the radar decoder. This tag is normally present in `radar.xml` and should not be changed. If changed, EDEX will likely cease processing radar data from the Radar Server.

### 7.3.5 Storing Decoded Data

Decoded radar data is stored in two locations: the AWIPS II Data Store and the AWIPS II metadata database

- The AWIPS II Metadata Database is hosted in PostgreSQL on the DX 1/2 cluster. The Radar metadata is stored in the `radar` and `radar_spatial` table of the `awips` schema of the metadata database.
- Decoded radar products are stored in HDF5 files in the AWIPS II Data Store on `dx2f`.



### 7.3.5.1 AWIPS II Metadata Database – Radar Metadata

AWIPS II software uses a PostgreSQL database to store product metadata, i.e., data that helps to identify decoded data. Physically, the database resides on the PowerVault – DAS. The PostgreSQL database Server software runs on DX1/2 cluster.

For AWIPS II, metadata is stored in the awips schema of the metadata database. Radar metadata resides in two tables: radar and radar\_spatial.

The radar table is a dynamic table that includes an entry for each decoded radar product that is available on the AWIPS II system. The radar\_spatial table is a static table that contains spatial data relating to the radar sites.

When Radar Data has been successfully ingested, the radar records are written to HDF5 files in the AWIPS II Data Store, and then the metadata is written to the database. At that point, the decoded data is available to client applications such as CAVE.

### 7.3.5.2 AWIPS II Data Store – Radar Products

Processed radar products are written to the AWIPS II Data Store. On the dx2f, the AWIPS II Data Store is mapped to /awips2/edex/data/hdf5/radar/<site>/.

Under /awips2/edex/data/hdf5/<site>/, the decoded radar products are stored in the radar site subdirectory.

For example, under /awips2/edex/data/hdf5/radar/kakq

```

TYPE:      ls -l
drwxr-xr-x 2 awips awips 4096 Aug 15 16:28 0.0
drwxr-xr-x 2 awips awips 4096 Aug 15 16:28 0.5
drwxr-xr-x 2 awips awips 4096 Aug 15 16:28 0.9
drwxr-xr-x 2 awips awips 4096 Aug 15 16:28 10.0
drwxr-xr-x 2 awips awips 4096 Aug 15 16:28 12.0
drwxr-xr-x 2 awips awips 4096 Aug 15 16:28 14.0
drwxr-xr-x 2 awips awips 4096 Aug 15 16:28 1.5
drwxr-xr-x 2 awips awips 4096 Apr 17 16:04 16.7
drwxr-xr-x 2 awips awips 4096 Aug 15 16:28 1.8
drwxr-xr-x 2 awips awips 4096 Aug 15 16:28 19.5
drwxr-xr-x 2 awips awips 4096 Aug 15 16:28 2.4
drwxr-xr-x 2 awips awips 4096 Aug 15 16:28 3.4
drwxr-xr-x 2 awips awips 4096 Aug 15 16:28 4.3
drwxr-xr-x 2 awips awips 4096 Aug 15 16:28 5.3
drwxr-xr-x 2 awips awips 4096 Aug 15 16:28 6.0
drwxr-xr-x 2 awips awips 4096 Aug 15 16:28 7.5

```

**Under 0.0**

```
radar-kakq-2013-01-09-13.h5  radar-kakq-2013-02-13-14.h5
radar-kakq-2013-01-10-20.h5  radar-kakq-2013-02-13-15.h5
radar-kakq-2013-01-22-16.h5  radar-kakq-2013-02-13-16.h5
radar-kakq-2013-02-07-18.h5  radar-kakq-2013-02-13-17.h5
radar-kakq-2013-02-13-03.h5  radar-kakq-2013-02-13-18.h5
radar-kakq-2013-02-13-04.h5  radar-kakq-2013-02-13-19.h5
radar-kakq-2013-02-13-05.h5  radar-kakq-2013-02-13-20.h5
radar-kakq-2013-02-13-06.h5  radar-kakq-2013-02-13-21.h5
radar-kakq-2013-02-13-07.h5  radar-kakq-2013-02-13-22.h5
radar-kakq-2013-02-13-08.h5  radar-kakq-2013-02-13-23.h5
radar-kakq-2013-02-13-09.h5  radar-kakq-2013-02-14-00.h5
radar-kakq-2013-02-13-10.h5  radar-kakq-2013-02-14-01.h5
radar-kakq-2013-02-13-11.h5  radar-kakq-2013-02-14-02.h5
radar-kakq-2013-02-13-12.h5  radar-kakq-2013-02-14-03.h5
radar-kakq-2013-02-13-13.h5  radar-kakq-2013-02-14-04.h5
```

### 7.3.6 Audible Radar-Alerting

AlertVIZ includes the capability to use audible alerting of messages on workstations that have audio capabilities. Adding an audio component to Radar Alerts involves modifying the AlertVIZ configuration on the workstation. To do this, use the configuration dialogs built into AlertVIZ.

- a. Right click on the AlertVIZ icon in the system and select *Configuration*. This will display the Alert Visualization *Configuration dialog*. (See Exhibit 7.3.6-1.)

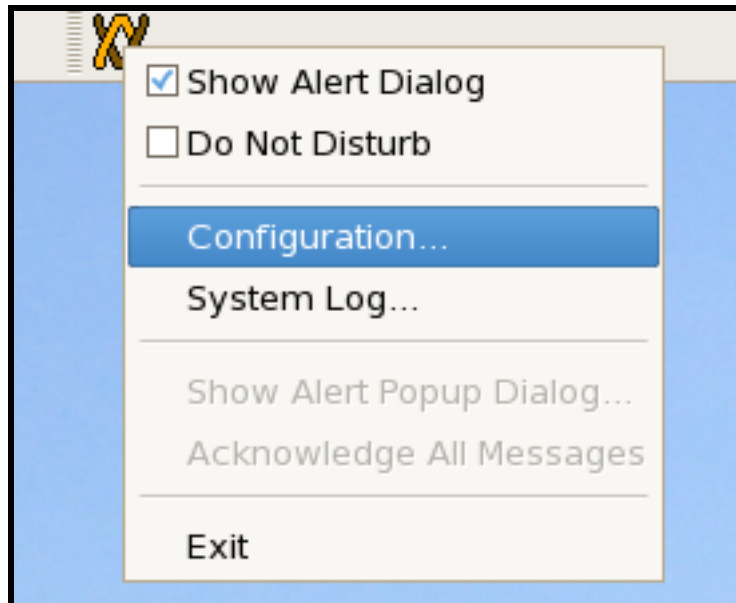
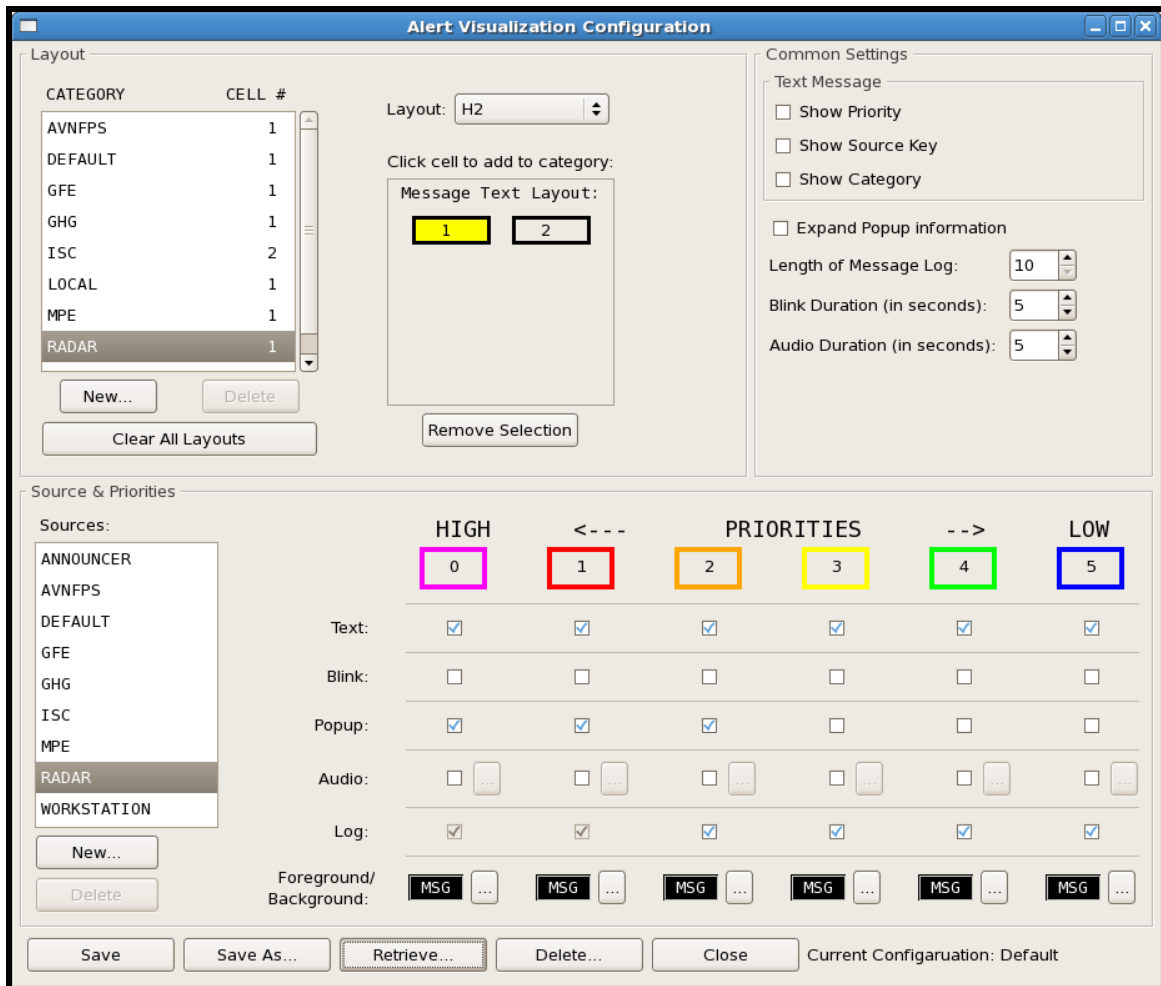

Exhibit 7.3.6-1. Alert Visualization Configuration dialog

- b. On the *Alert Visualization Configuration* dialog, select *RADAR* from the list box under *Sources & Priorities* at the lower left of the dialog. This will load the alerting information for *RADAR* into the lower control group. (See Exhibit 7.3.6-2).



**Exhibit 7.3.6-2. Alert Visualization Configuration Sources & Priorities**

- c. In the *Sources & Priorities* control group, make sure *RADAR* in the *Sources* menu is selected in the list box, and then click the *Audio* check box under *HIGH*. (See Exhibit 7.3.6-3.)



**Exhibit 7.3.6-3. Alert Visualization Configuration Sources & Priorities Audio**

- d. Selecting the *Audio* checkbox activates the *Audio* browse button. Click the *browse* button. This will display the *Audio File Selection* dialog. This dialog displays the currently available audio files. (See Exhibit 7.3.6-4.)

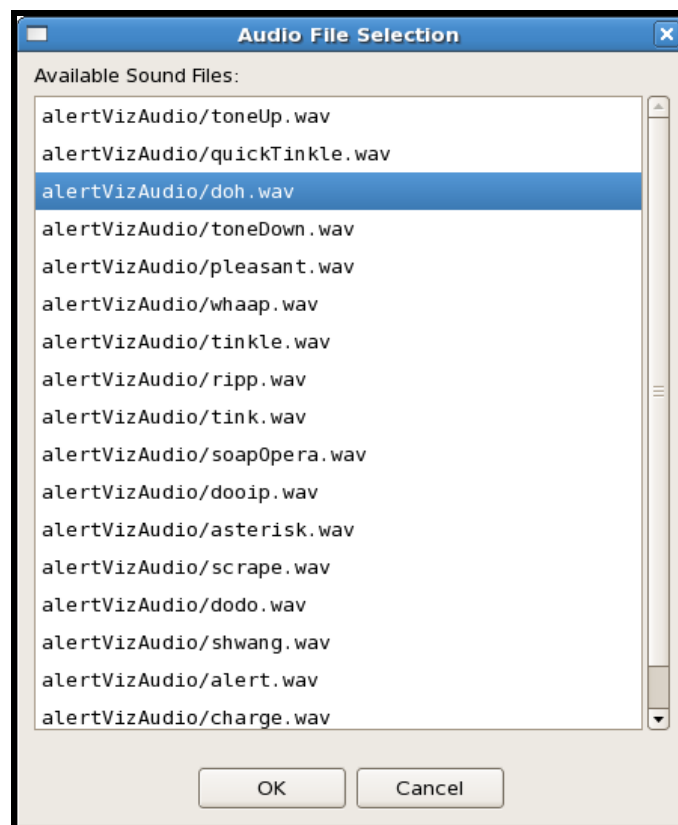

**Exhibit 7.3.6-4. Alert Visualization Configuration Sources & Priorities Audio File**

- e. Select desired sound file and click *OK*.

- f. To save the modification to the Alert VIZ configuration, click the *Save As ...* button at the bottom of the *Alert Visualization Configuration* dialog. This opens the *Configuration List* dialog in save mode. (See Exhibit 7.3.6-5.)

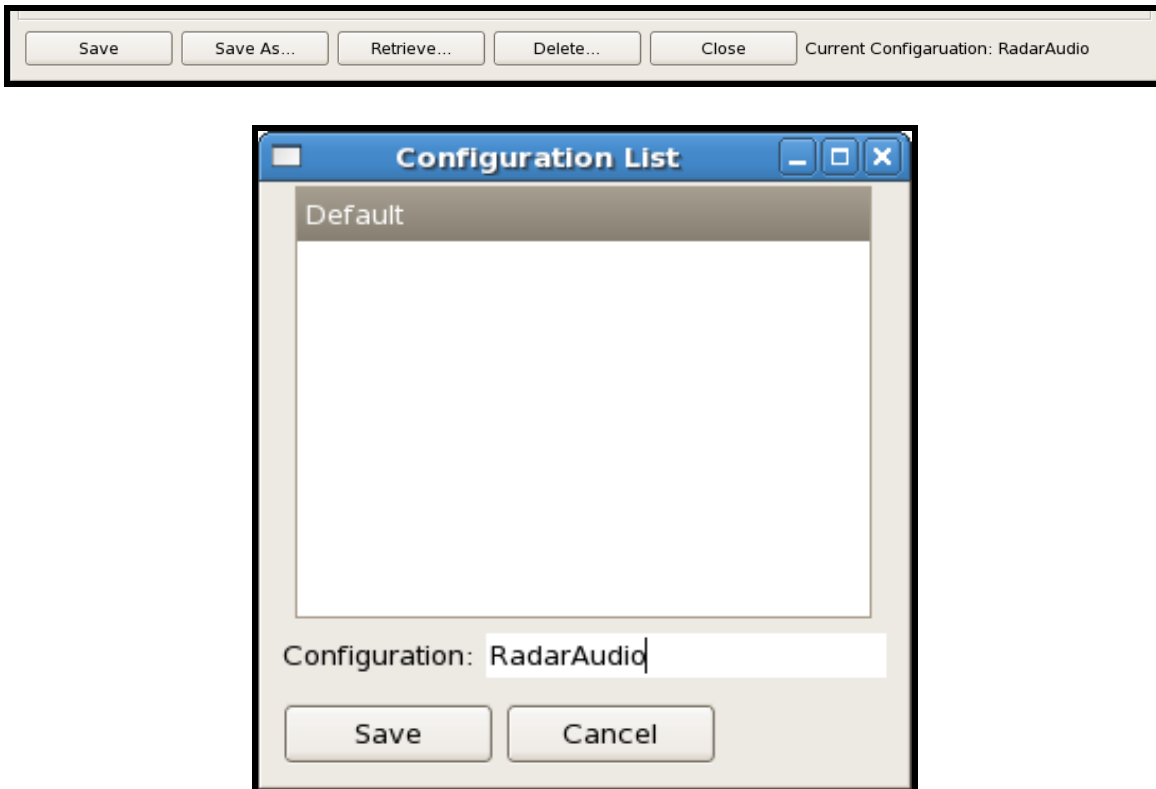

**Exhibit 7.3.6-5. Alert Visualization Configuration List**

- g. Once the dialog is open, enter a name for the configuration and click *Save*. The *Alert Visualization Configuration* dialog will update to show your new configuration as the current configuration.

Once the configuration has been changed, a restart of Alert VIZ will result in the new configuration being loaded.

Note that the new configuration is saved in the AWIPS-II data localization store for the current user. As a result, the newly updated configuration is available for that user on all workstations.

#### **7.4 WAN/SBN Radar Product Distribution from Site to NCF**

The AWIPS WAN/SBN distribution capability allows sites to distribute radar products over the WAN to the NCF for redistribution to all AWIPS sites over the SBN. Table 7.4-1 lists the product number and name, levels, layer, resolution and range, product ID, and format for WSR-88D products on AWIPS.

Table 7.4-1. WSR-88D Products on AWIPS

Prod Num	Lvls	Lyr	Resol	Range	Prod ID	Product Name	Format
2	0	0	0	0	GSM	General Status Msg (GSM)	GSM
3	0	0	0	0	PRR	Product Request Resp (PRR)	PRR
8	0	0	0	0	PTL	Product List (PTL)	PTL
12	0	0	0	0	CPM	Command Parameter Message	CPM
14	0	0	0	0	CCM	Command Control Message	CCM
19	16	0	1	230	Z	Reflectivity (Z)	Radial
20	16	0	2	460	Z	Reflectivity (Z)	Radial
25	16	0	0.25	60	V	Velocity (V)	Radial
26	16	0	0.5	115	V	Velocity (V)	Radial
27	16	0	1	230	V	Velocity (V)	Radial
28	8	0	0.25	60	SW	Spectrum Width (SW)	Radial
30	8	0	1	230	SW	Spectrum Width (SW)	Radial
31	16	0	2	230	USP	User Select Precip (USP)	Radial
32	256	0	1	115	DHR	Digital Hybrid Scan Refl (DHR)	Radial
33							
34	8	0	1	230	CFC	Clutter Filter Control (CFC)	Radial
37	16	0	1	230	CZ	Composite Ref (CZ)	Raster
38	16	0	4	460	CZ	Composite Ref (CZ)	Raster
39	0	0	1	230	CZC	Composite Ref Contour (CZC)	Graphic
40	0	0	4	460	CZC	Composite Ref Contour (CZC)	Graphic
41	16	0	4	230	ET	Echo Tops (ET)	Raster
42	0	0	4	230	ETC	Echo Tops Contour (ETC)	Graphic
43	16	0	1	230	SWR	Svr Wx Anal - Ref (SWR)	Radial
44	16	0	0.25	230	SWV	Svr Wx Anal - Vel (SWV)	Radial
45	8	0	0.25	230	SWW	Svr Wx Anal - SW (SWW)	Radial
46	16	0	0.5	230	SWS	Svr Wx Anal - Shear (SWS)	Radial
47	0	0	4	230	SWP	Severe Wx Prob (SWP)	Graphic
48	8	0	0	0	VWP	VAD Wind Profile (VWP)	Graphic
49	16	0	0	26	CM	Combined Moment (CM)	Raster
50	16	0	1	230	RCS	Ref X-Sect (RCS)	Raster
51	16	0	0.5	230	VCS	Vel X-Sect (VCS)	Raster
52	8	0	0.5	230	SCS	SW X-Sect (SCS)	Raster
53	8	0	1	50	WER	Wk Echo Region (WER)	Raster
56	16	0	1	230	SRM	Storm Rel Velocity (SRM)	Radial
57	16	0	4	230	VIL	Vert Integ Liq (VIL)	Raster
58	0	0	0	345	STI	Storm Track (STI)	Graphic
59	0	0	0	230	HI	Hail Index (HI)	Graphic
60	0	0	0	230	M	Mesocyclone (M)	Graphic
61	0	0	0	230	TVS	Tornadic Vortex Sig (TVS)	Graphic
62	0	0	0	460	SS	Storm Structure (SS)	Text
65	8	1	4	460	LRM	Lyr 1 Comp Ref Max (LRM)	Raster
66	8	2	4	460	LRM	Lyr 2 Comp Ref Max (LRM)	Raster

Prod Num	Lvls	Lyr	Resol	Range	Prod ID	Product Name	Format
67	8	2	4	460	APR	Lyr 1 Comp Ref MAX (APR)	Raster
74	0	0	0	460	RCM	Radar Coded Message (RCM)	Text
75	0	0	0	0	FTM	Free Text Message (FTM)	Text
77	0	0	0	0	PTM	PUP Text Message (PTM)	Text
78	16	0	2	230	OHP	One Hour Precip (OHP)	Radial
79	16	0	2	230	THP	Three Hour Precip (THP)	Radial
80	16	0	2	230	STP	Storm Total Precip (STP)	Radial
81	256	0	4	230	DPA	Digital Precip Array (DPA)	Raster
82	8	0	40	230	SPD	Supplemental Precip Data (SPD)	Text
83	0	0	0	0	IRM	Intermediate Radar Message (IRM)	Text
84	8	0	0	0	VAD	Vel Az Display (VAD)	Graphic
87	0	0	2	0	CS	Combined Shear (CS)	Raster
88	0	0	2	0	CSC	Combined Shear Contour (CSC)	Graphic
90	8	3	4	460	LRM	Lyr 3 Comp Ref Max (LRM)	Raster
93	256	0	1.00	115	DBV	ITWS Digital Velocity (DBV)	Radial
94	256	0	1.00	460	DZ	8-bit Refl Array (DZ)	Radial
99	256	0	0.25	230	V	8-bit Velocity Array (V)	Radial
100	0	0	0	0	VSDT	VAD Site Adapt Params (VSDT)	Text
101	0	0	0	0	STIT	Storm Track Alpha block (STIT)	Text
102	0	0	0	0	HIT	Hail Index Alpha block (HIT)	Text
103	0	0	0	0	MT	Mesocyclone Alpha block (MT)	Text
104	0	0	0	0	TVST	TVS Alpha block (TVST)	Text
105	0	0	0	0	CST	Combined Shear Params (CST)	Text
106	0	0	0	0	CSCT	Combined Shr Cntr Parm (CSCT)	Text
107	0	0	0	0	OHPT	1hr Rainfall Params (OHPT)	Text
108	0	0	0	0	THPT	3hr Rainfall Params (THPT)	Text
109	0	0	0	0	STPT	Storm Total Params (STPT)	Text
136	16	0	4	0	CZFMP	Comp Refl Mos Filt Prec(CZFMP)	Raster
137	16	0	8	0	CZFMP	Comp Refl Mos Filt Prec(CZFMP)	Raster
139	16	0	4	0	CZM	Composite Refl Mosaic (CZM)	Raster
144	16	0	8	0	CZM	Composite Refl Mosaic (CZM)	Raster
153	256	0	0.25	460	HZ	Super-Res Reflectivity (Z)	Radial
154	256	0	0.25	300	HV	Super-Res Velocity (V)	Radial
155	256	0	0.25	300	HSW	Super-Res Spec Width (SW)	Radial
159	8	0	4	300	ZDR	Differential Refl (ZDR)	Raster
161	256	0	0.25	300	CC	Correlation Coeff (CC)	Radial
163	256	0	0.25	300	KDP	Specific Diff Phase (KDP)	Radial
165	256	0	0.25	300	HC	Hydrometer Class (HC)	Radial
166	0	0	0.0	230	ML	Melting Layer (ML)	Graphic
169	16	0	2.0	230	OHA	One Hour Accum (STA)	Radial
170	256	0	0.25	230	DAA	One Hour Unbiased Accum (DAA)	Radial
171	16	0	2.0	230	STA	Storm Total Accum (STA)	Radial
172	256	0	0.25	230	STA	Storm Total Accum (DSA)	Radial

Prod Num	Lvls	Lyr	Resol	Range	Prod ID	Product Name	Format
173	256	0	0.25	230	DUA	User Select Accum (DUA)	Radial
174	256	0	0.25	230	DOD	One Hour Diff (DOD)	Radial
175	256	0	0.25	230	DSD	Storm Total Diff (DSD)	Radial
176	65536	0	0.25	230	DPR	Digital Inst Precip rate (DPR)	Radial
177	256	0	0.25	230	HHC	Hybrid Hydrometer Class (HHC)	Radial
199	16	0	4	0	OHPM	One Hour Precip Mosaic (OHPM)	Raster
200	16	0	8	0	OHPM	One Hour Precip Mosaic (OHPM)	Raster
202	0	0	0	0	SCC	Shift Change Checklist	Text
204	16	0	4	0	ETM	Echo Tops Mosaic (ETM)	Raster
205	16	0	8	0	ETM	Echo Tops Mosaic (ETM)	Raster
208	0	0	0	0	CSAM9	Com Storms Att Mosaic B9 (CSAM9)	Raster
209	0	0	0	0	CSAM	Comb Storms Att Mosaic (CSAM)	Raster
210	16	0	4	0	CPAM	Cum Precip Accum Mosaic (CPAM)	Raster
211	16	0	4	0	ODPM	24-Hr Precip Mosaic (ODPM)	Raster
212	16	0	4	0	CZMP	Comp Refl Mosaic Precip (CZMP)	Raster
213	16	0	8	0	CZMP	Comp Refl Mosaic Precip (CZMP)	Raster
216	16	0	8	0	CPAM	Cum Precip Accum Mosaic (CPAM)	Raster
217	16	0	8	0	ODPM	24-Hr Precip Mosaic (ODPM)	Raster
246	16	0	2	0	ZNM	Refl Mos Non Filt (ZNM)	Raster
247	16	0	2	0	ZNMC	Refl Mos Non Filt Clr (ZNMC)	Raster
249	16	0	2	0	ZM	Base Reflectivity Mosaic (ZM)	Raster
250	16	0	4	0	ZM	Base Reflectivity Mosaic (ZM)	Raster
251	16	0	8	0	ZM	Base Reflectivity Mosaic (ZM)	Raster
253	16	0	4	0	ZMGA	Base Refl Mos Griff+Alb (ZMGA)	Raster
254	8	0	4	0	LRMM	Layer Comp Refl Low Mos (VILM)	Raster
255	8	0	8	0	LRMM	Layer Comp Refl Med Mos (VILM)	Raster
256	8	0	8	0	LRMM	Layer Comp Refl High Mos (VILM)	Raster
257	16	0	4	0	VILM	Vert Int Liquid Mosaic (VILM)	Raster

**NOTE:** Level III data are radar products generated from the Level II base data. The products are used to assist forecasters and others in weather analysis, predictions, and warnings. Level III products used to be recorded on WORM Optical Disks at NWS sites in the early 1990s. Currently, the required products are provided electronically in near real-time to an NWS Central Collection Facility (CCF). When products were written to the WORM Optical Disks, all products were saved and archived. Now, only required products are collected at the CCF and then archived by National Climatic Data Center (NCDC). Regardless of how the Level III products have been received, the NCDC archives the products in compressed tape archive format on the NCDC Hierarchical Data Storage System (HDSS). The Level III Products archive is available via the World Wide Web on the NCDC Home Page (<http://www.ncdc.noaa.gov/>).

For more information on this subject, go to:



[http://www.roc.noaa.gov/WSR88D/Level\\_III/Level3Info.aspx](http://www.roc.noaa.gov/WSR88D/Level_III/Level3Info.aspx)

## 7.5 *RPS list*

The RPS list is edited using a Graphical User Interface (GUI) that is part of CAVE. It is accessed via the Radar menu in the D2D perspective.

**NOTE:** When you add products to the RPS list with the AWIPS RPS List Editor, you specify the specific parameters but not the Product Number. If the product is entered in the RPS list with incorrect parameters, it will be interpreted as a different product and not distributed automatically to the WAN. It is very important that the data level, resolution, and elevation be specified correctly in the RPS list or the product will not be distributed properly.

To edit the RPS list:

1. Start CAVE and, if necessary, open the D2D perspective.
2. Select *RPS List Editor...* under the Radar menu. The RPS List Editor will display. (See Exhibit 7.5-1.)

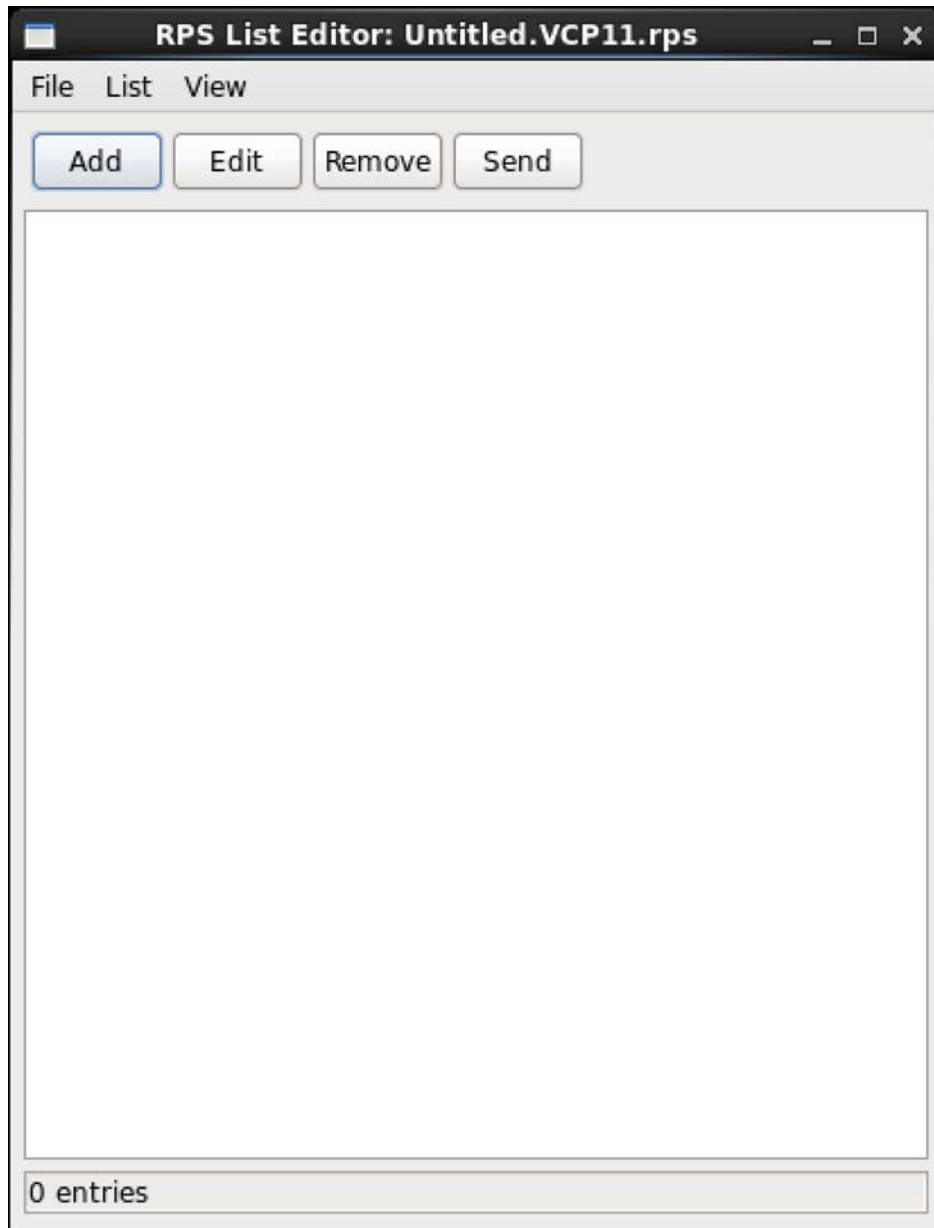

**Exhibit 7.5-1. RPS List Editor**

3. Select the list you want to edit under the View Menu. (See Exhibit 7.5-2.)

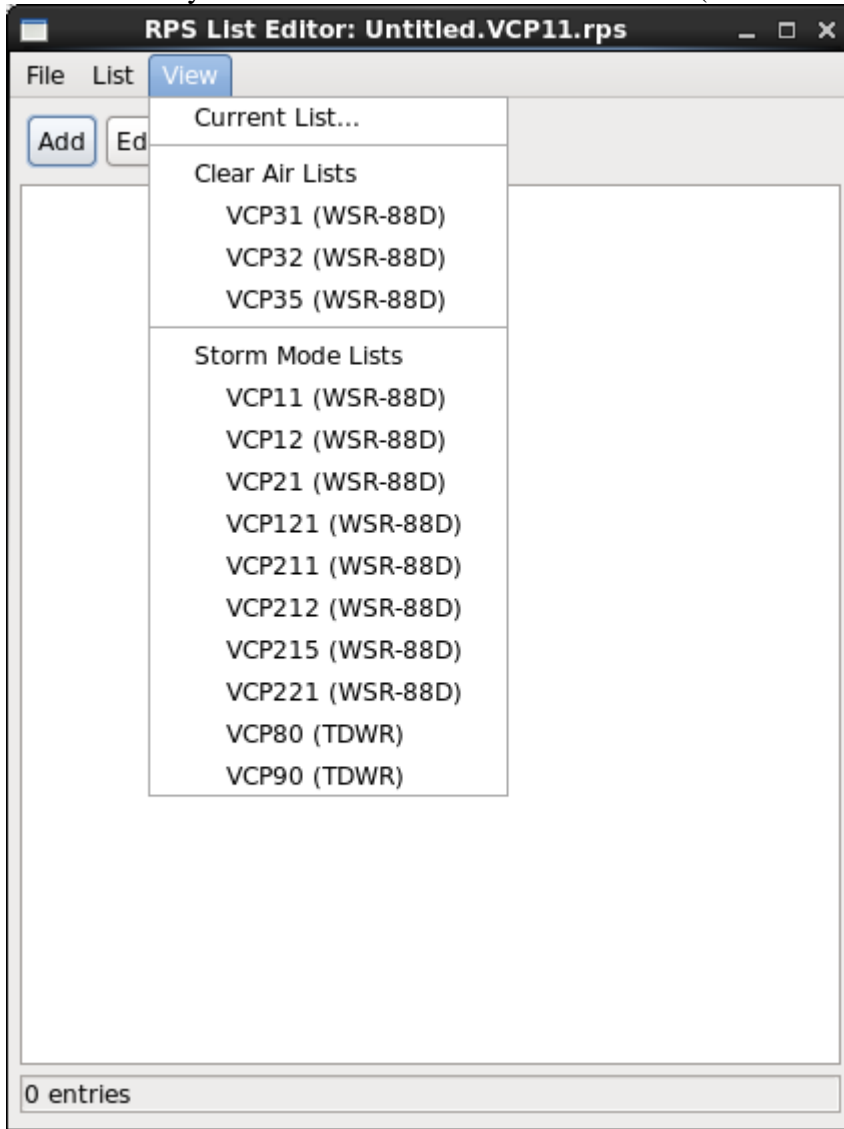

**Exhibit 7.5-2. RPS List Editor View Menu – Select List**

4. After selecting the desired list, it will be displayed in the RPS List Editor. (See Exhibit 7.5-4.)

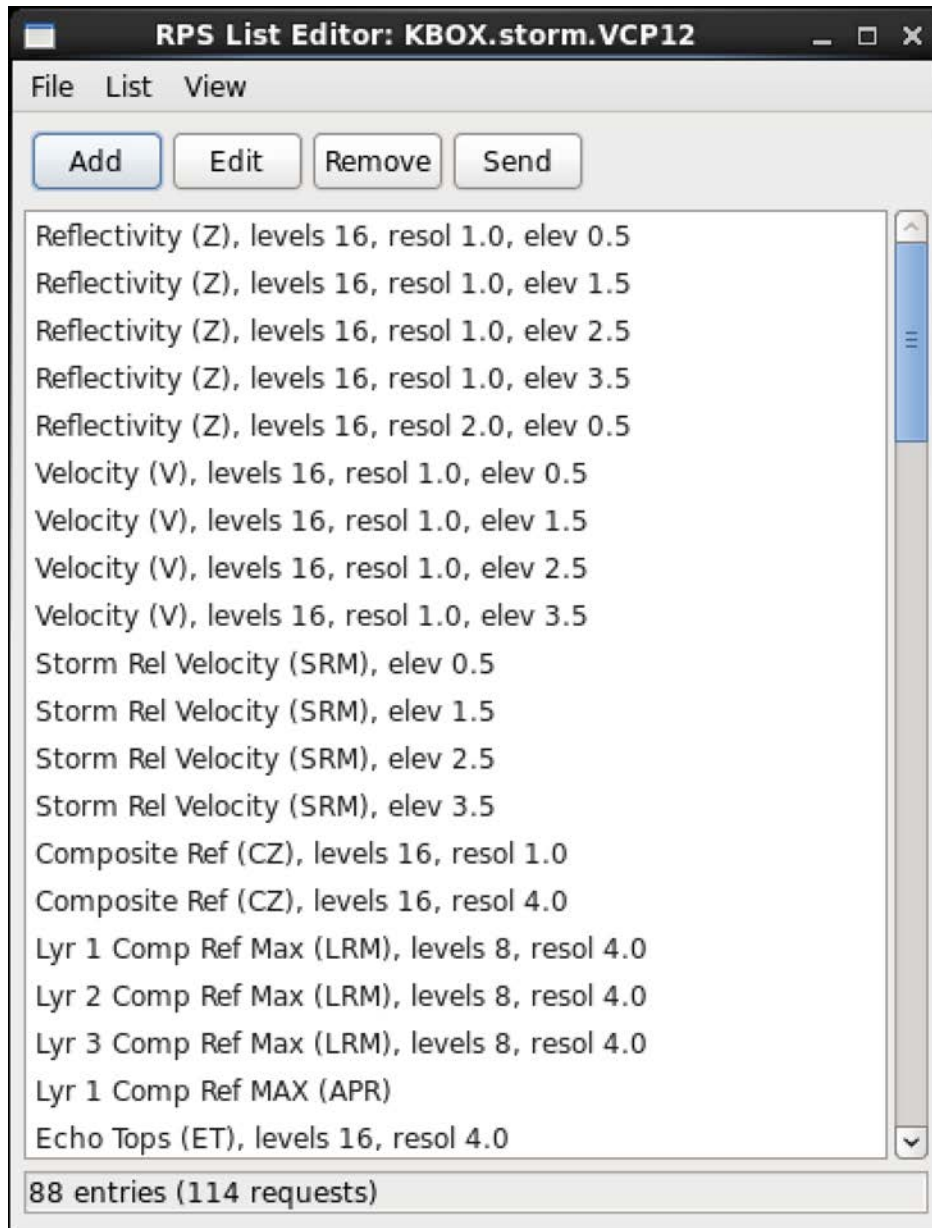

Exhibit 7.5-3. RPS List Editor View Menu List

5. To edit a list entry, select the entry and click *Edit*. Once the entry is displayed in a separate dialog, modify the appropriate values and click *OK*. (See Exhibit 7.5-5.)

The screenshot shows a dialog box titled 'RPS List Editor View Menu List Edit'. It contains the following fields and controls:

- Product:** A text box containing 'Reflectivity (Z)'.
- Priority:** A dropdown menu set to 'Normal'.
- Request interval:** A slider control set to '1'.
- Elevation(s):** Two dropdown menus, the first set to 'Single' and the second set to '0.5'.
- Variant:** A text box containing '16 levels 1.00 res 230.0km'.

At the bottom of the dialog are two buttons: 'OK' and 'Cancel'.

**Exhibit 7.5-4. RPS List Editor View Menu List Edit**

6. To add a new list entry, click *New*. Once the dialog is displayed, select the appropriate entries and click *OK*.
7. To delete a list entry, select the entry and click *Remove*.
8. To submit the list, click *Send*.

## 7.6 Two-Way Communication

As illustrated in Exhibit 7.6-1, the Quartz timer task in EDEX initiates either environmental data or bias table task. The EDEX queries the RadarServer for the list of ORPGs/SPGs (For the environmental data task, EDEX queries the grib data set based on the settings in EnvironParamsLevelTable.xml and generates environmental data message. For the bias table task, EDEX looks for bias table messages that were generated by the hdyro software). The EDEX sends the messages to the RadarServer and the RadarServer sends the messages to the ORPGs/SPGs.

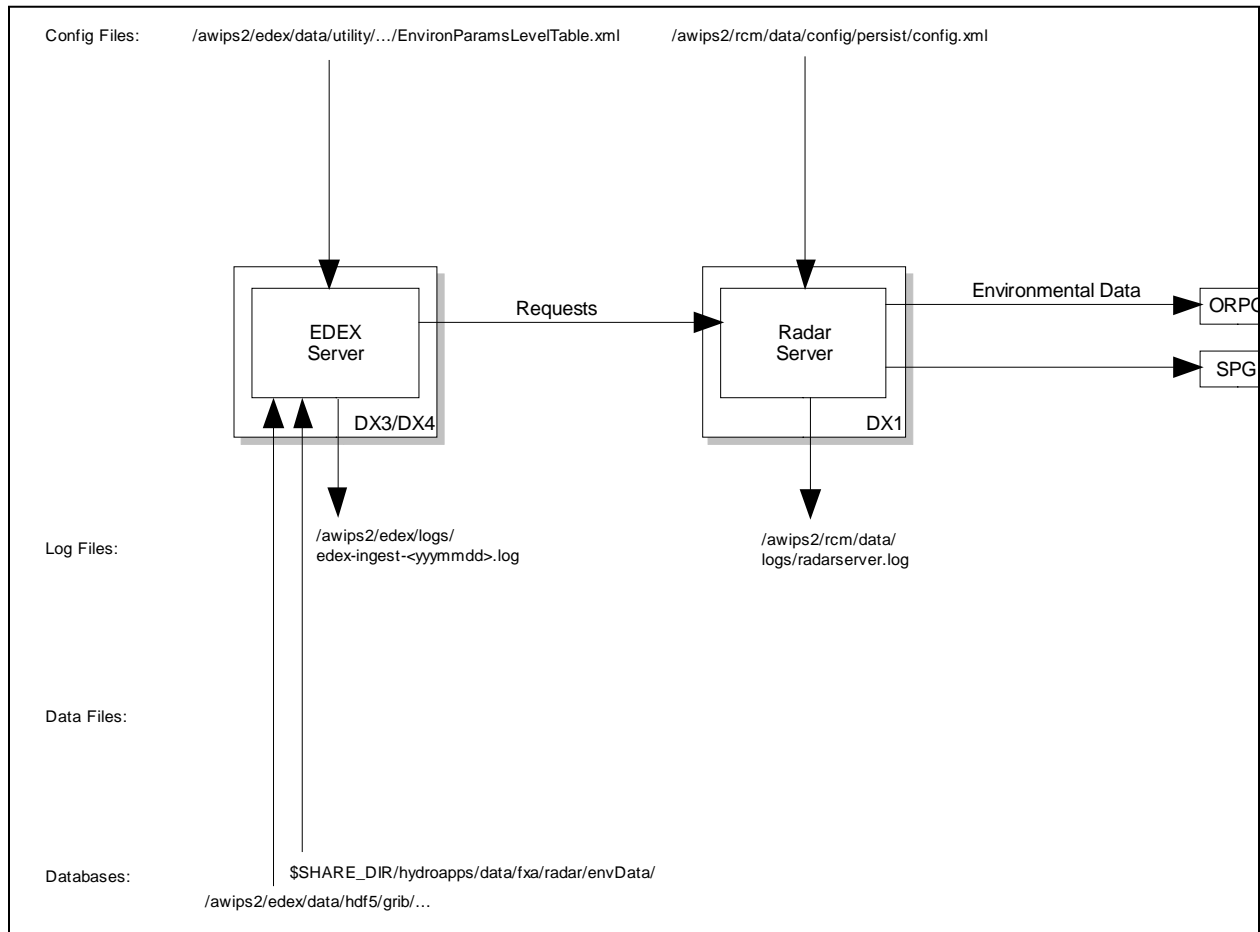

**Exhibit 7.6-1. Sending Environmental Data**

As illustrated in Exhibit 7.6-2:

- **For OTRs:** The CAVE sends requests to the RadarServer which are forwarded to the ORPG and the RadarServer sends OTR status back to CAVE (Not shown).
- **For RMRs:** The CAVE reads and writes the list of available RMRs using the EDEX localization requests. Then the Requests to activate/deactivate RMR requests are sent to the RadarServer. The RadarServer sends the OTR requests to the ORPGs/SPGs according to the contents of the RMR and the RadarServer sends RMR status events back to CAVE while the RMR window is open (not shown).
- **For RPS:** The CAVE queries the RadarServer for the current RPS list. To activate an RPS list, CAVE first sends a request to the RadarServer which then sends an RPS message to the ORPG/SPG.
- **For VCP changes:** The CAVE reads the current RadarServer VCP settings and sends requests to the RadarServer which are forwarded to the ORPG.

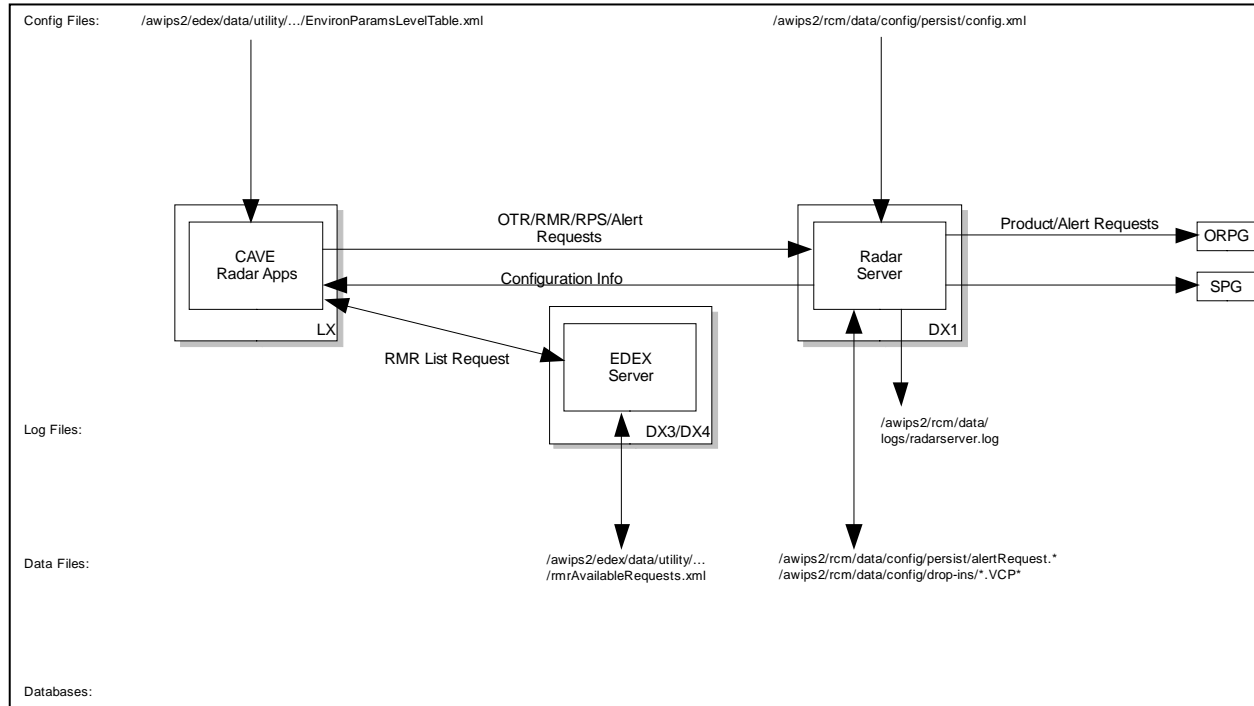

Exhibit 7.6-2. Sending Radar Applications

## 7.7 Central Collection Cron Schedule

The two cron entries for Central Collection Cron Schedule in `cronOTRs.xml` are as follows.

```
<cronOTR cron="0 10 * * * ?" productCode="173" randomWait="300"
hoursBack="3" wmo="SDUS8" nnn="DU3" />
```

```
<cronOTR cron="0 10 12 * * ?" productCode="173" randomWait="300"
hoursBack="24" wmo="SDUS8" nnn="DU6" />.
```

## 7.8 ORPG Backup Operations in AWIPS II

A dedicated connection can be established via the WAN to non-dedicated radar. WAN Dedicated (ORPG Backup) connections work much the same as WAN OTR/RMR. However, with the ORPG backup come's the constant connection with the ability to send an RPS list, rather than just sending one-time or multiple requests that require occasional to frequent user interaction. In AWIPS II, the Radar Server Configuration GUI can be used to both initiate and terminate an ORPG Backup connection. Care must be taken using this GUI as it also has the ability to disconnect a site's own dedicated radar connection, as well.

Establishing this connection in AWIPS I came at the cost of disabling the flow of radar data via the SBN for the radar to which the connection is established. In AWIPS II, the SBN data flow will continue even when the ORPG Backup connection is established

assuming that the primary WFO's connection to the radar is still active and their system is still able to transmit the data. Thus, when generating RPS lists, make sure not to include any products that are already included in the SBN transmission. The exception to this recommendation is if your site is previously configured for and plans to use this backup radar in FSI. Raw radar data is stored differently based on whether it comes from a dedicated connection or the SBN. FSI is configured to only use data obtained via a dedicated connection based on its raw data storage location. Therefore, if your site is pre-configured for and plans to use FSI for this backup radar, then make sure all products you would like to see in FSI are included in the RPS lists.

As in AWIPS I, there is only 1 port available on each RPG for a WAN Dedicated connection and the bandwidth is shared with that of the 4 OTR/RMR ports. Therefore it is important that a connection be made in coordination with other offices that may also need or be interested in the same connection and in consideration of those that may be interested in performing OTR/RMR operations. Also as in AWIPS I, such a connection could have negative impacts on overall bandwidth utilization, thus causing problems sending and receiving all types of products for the primary and the backup WFO. Given these limitations, this connection should only be activated when severe weather is imminent or occurring. Similarly, the connection should be terminated immediately as soon as the event, weather-related or otherwise, that necessitated the connection abates.

The remainder of these instructions assumes that all associated radar files have previously been configured and RPS lists have been generated for ORPG Backup operations. If such a connection has never previously been configured or utilized, please contact the Radar Operations Center (ROC) for a Radar File Help Sheet for your office which will include the instructions to modify the configuration files necessary to make such a connection. If your site was properly configured for ORPG Backup operations in AWIPS I, the configuration would have been migrated over to AWIPS II on your installation day.

There remain two types of ORPG Backup connections, as described below:

**Scenario 1:** Routine Operational Purposes (No WAN Reporting). This is used for:

- Severe weather in or near CWA which is covered well by an adjacent radar
- Backup, either routine or emergency, of another WFO in which the other office is still able to obtain and transmit their own radar data

**Scenario 2:** True Radar Backup Purposes (WAN Reporting). This is used for:

- Backup, either routine or emergency, of another WFO that has some sort of intrusive install or failure in which they are still on the AWIPS WAN, but are not able to either obtain or transmit their own radar data for central collection and distribution via the SBN



## Procedure:

Prior to initiating either scenario of WAN Dedicated radar backup, be sure to coordinate with the WFO that shares access to the radar in question to be sure that the port is free and the office with the higher priority has access to make the connection. Also for both scenarios, the first few steps are the same.

1. In CAVE, go to the D2D Perspective.
2. Click on Radar > Radar Server Configuration..

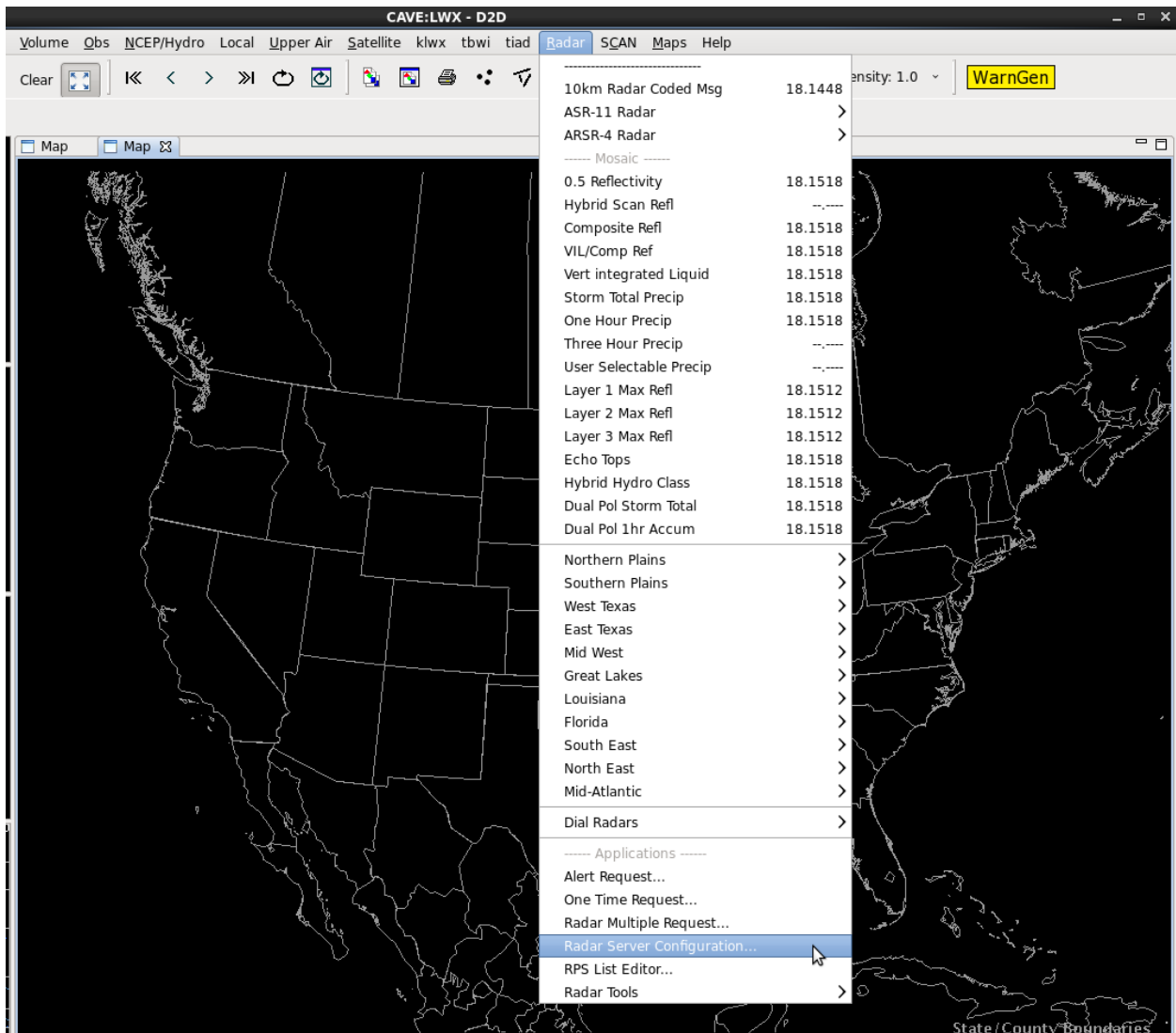

**Exhibit 7.8-1. D2D Perspective in CAVE with the Radar menu selected and Radar Server Configuration highlighted**

3. In the GUI, scroll down under the '-- Dial Radars --' section of the RPGs box on the left-hand side and click on the radar for which you would like to initiate a backup.

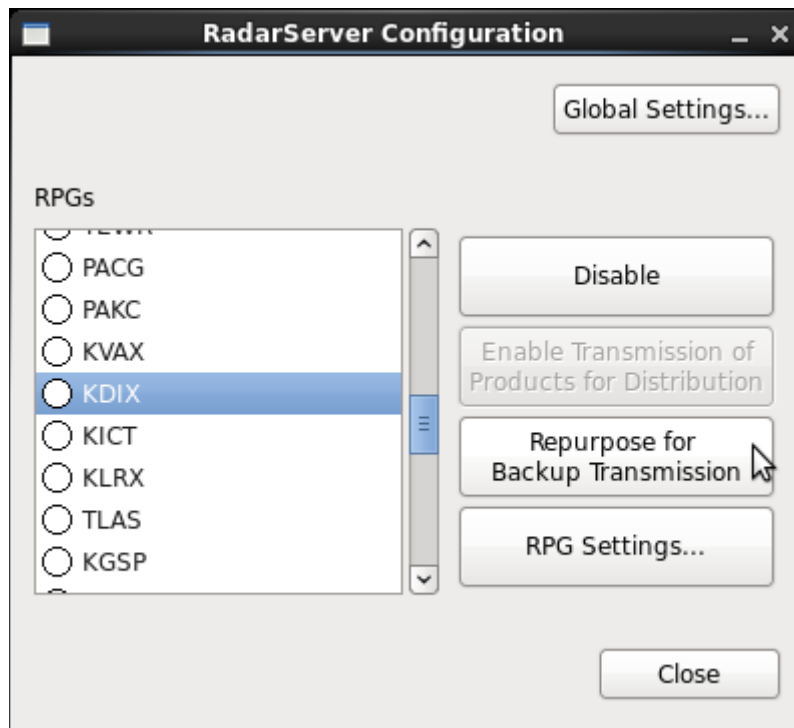
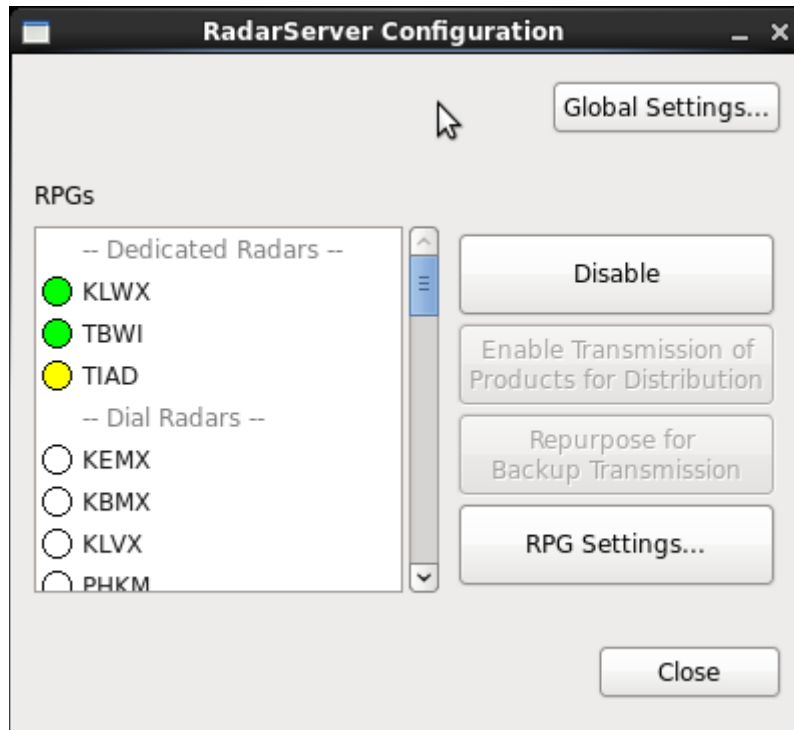

**Exhibit 7.8-2. Select List Select the RPG (Step #3, above) and Repurpose for Backup Transmission (Step #4, below)**

4. With the radar selected, click the 'Repurpose for Backup Transmission' button on the right-hand side to start the connection. At this point the connection is live. The radar

moves up to the ‘-- Dedicated Radars --’ section and the circle next to the radar name is filled green.

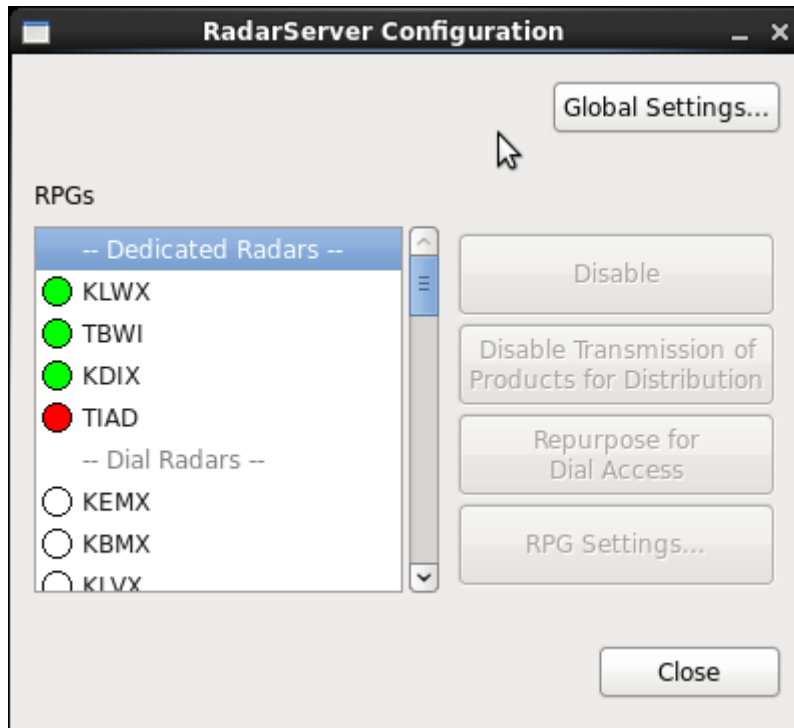

**Exhibit 7.8-3.** The status after Step #4 – KDIX listed under Dedicated Radars with a green circle

**Note:** The default behavior is for the data obtained via this new WAN Dedicated backup to transmit via your site’s MHS to central collection for redistribution on the SBN. This is what one would want if participating in a **Scenario 2: True Radar Backup**. If this is your intention, your connection is now complete and you may proceed with the backup until you are ready to terminate. Otherwise, proceed to Step 5 for **Scenario 1: Routine Operational Backup** to disable the transmission of products.

5. The ‘<Enable|Disable> Transmission of Products for Distribution’ button will display ‘Disable’ when transmission of products is enabled. Select the backup radar under the ‘--Dedicated Radars --’ list then click the ‘Disable Transmission of Products for Distribution’ button to disable the transmission of products and keep all products obtained via this connection in-house only. The button will then change to ‘Enable Transmission of Products for Distribution’.

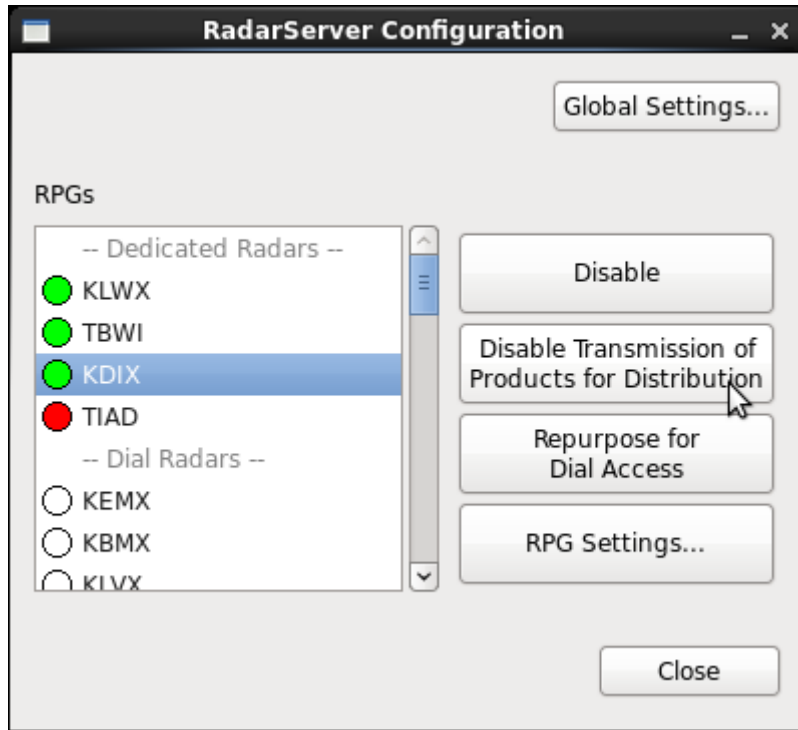
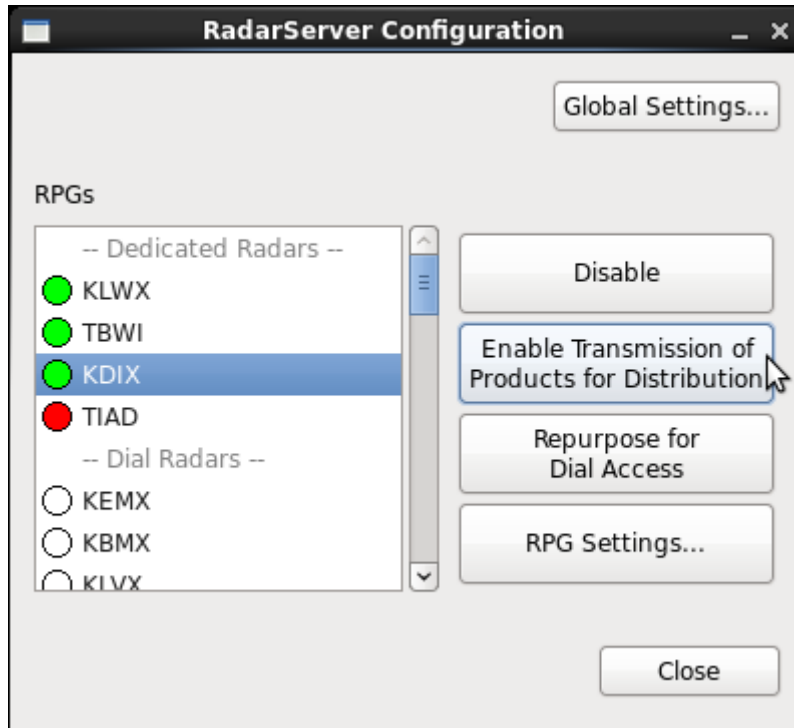

Exhibit 7.8-4. Transmission of Products is enabled.

**Scenario 1** connection is now complete. The GUI should look like this:

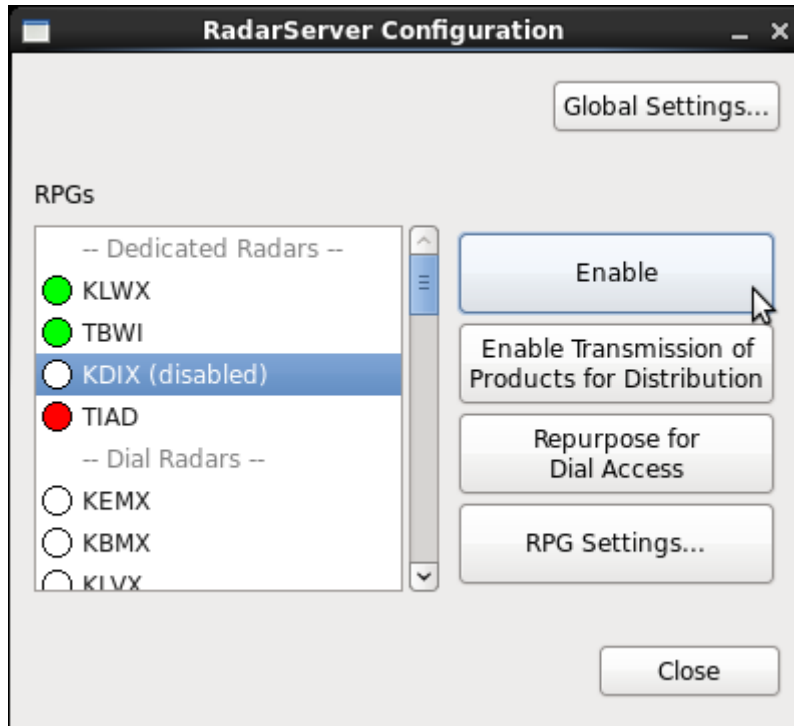

**Exhibit 7.8-5. Transmission of Products disabled.**

Proceed with the backup until you are ready to terminate the connection. Once ready for termination, please follow the steps outlined below.

### **Terminate WAN Dedicated Backup:**

1. From the Radar Server Configuration GUI, click on the radar name under the '-- Dedicated Radars --' section of the RPGs box on the left-hand side of the GUI.
2. Click 'Disable' on the right-hand side of the GUI. The button itself changes to 'Enable'. The radar remains under the '-- Dedicated Radars --' section, but the circle to the left of the radar name turns white and '(disabled)' appears to the right of the radar name.



**Exhibit 7.8-6. The connection has been disabled, but is still listed as a dedicated radar**

3. Make sure the radar is still selected under the '-- Dedicated radars --' section and then click the 'Repurpose for Dial Access' button on the right-hand side. The radar moves back to the '-- Dial Radars --' section of the RPGs box and continues to display '(disabled)'.

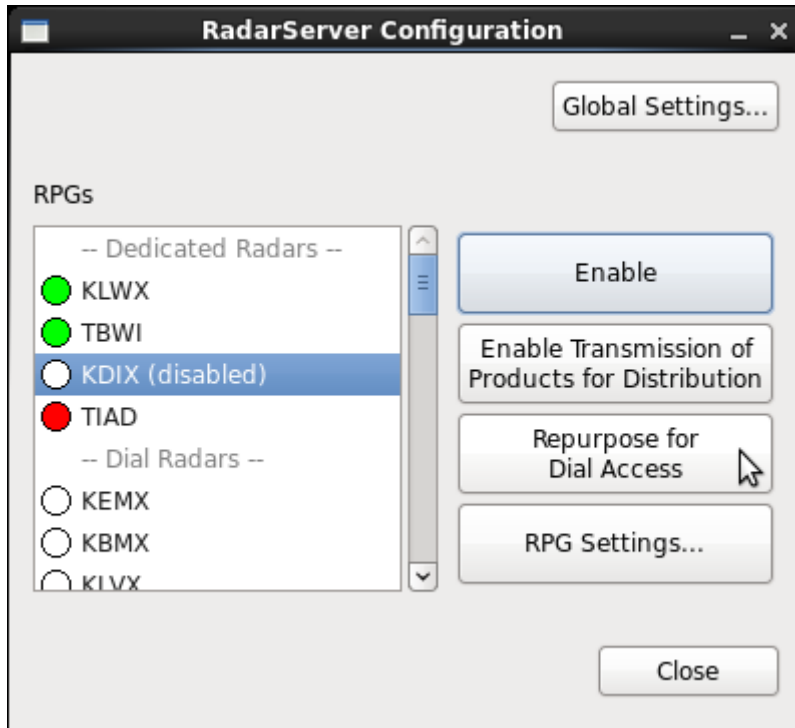

Exhibit 7.8-7. 'Repurpose for Dial Access' button is active

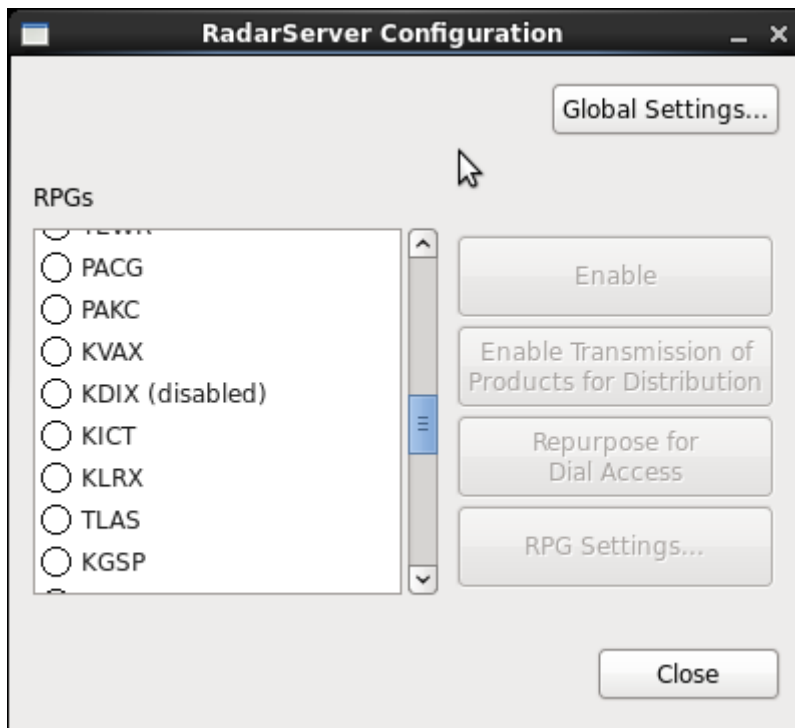
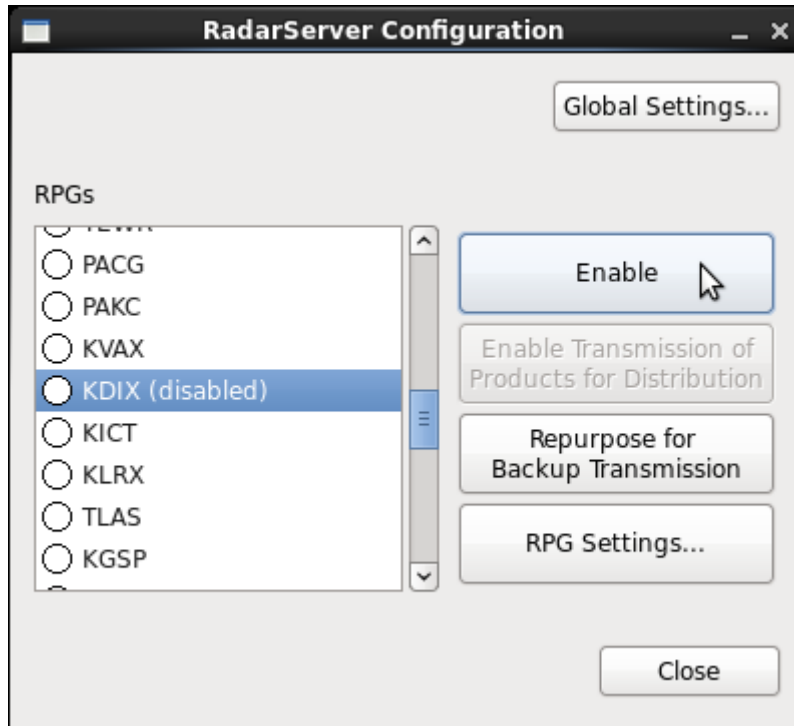

Exhibit 7.8-8. 'Repurpose for Dial Access' button is clicked, the radar moves down to the Dial Radars list, but still says '(disabled)'

4. To ensure that OTR and RMR will work for this radar until the next WAN Dedicated backup connection is needed, scroll down to the '-- Dial Radars --' section in the RPGs box and select the radar once again.



**Exhibit 7.8-9. Radar is still disabled and the Enable button is active**

5. Click on 'Enable'. The '(disabled)' will then be removed from the right of the radar name. This will allow OTR/RMR to work once again for that radar and will also set it up properly such that the steps provided in this document can be followed as they are written for future WAN Dedicated Backups.



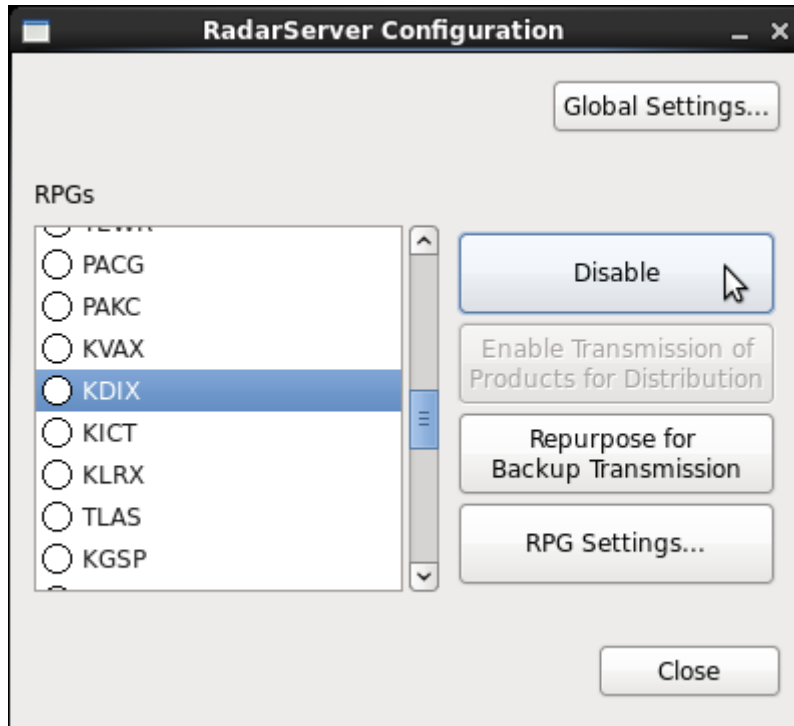

**Exhibit 7.8-10.** The radar is disabled for WAN Dedicated operations, but enabled for OTR/RMR operations

## Log Files:

For office admins that would like to confirm that the backup is functioning, everything is logged to `dx1f:/awips2/rcm/data/logs/radarserver.log`.

- An example of when a connection is made:

```
INFO 16:50:06,171 [ActiveMQ Session Task] RadarServer: Got remote request
SetRadarConfig(kdix)
INFO 16:50:06,188 [ActiveMQ Session Task] RadarServer: Configuration saved
INFO 16:50:06,190 [Thread-45263] RadarServer: kdix: Attempt connection to
165.92.56.75:4493
INFO 16:50:06,208 [Thread-45263] RadarServer: kdix: Connected to
165.92.56.75:4493
INFO 16:50:06,208 [Thread-45263] RadarServer: kdix: Attempt connection to
165.92.56.75:4493
INFO 16:50:06,216 [ActiveMQ Session Task] RadarServer: Got remote request
GetRadarConfig(null)
INFO 16:50:06,225 [Thread-45263] RadarServer: kdix: Connected to
165.92.56.75:4493
INFO 16:50:06,244 [Thread-45263] RadarServer: kdix: connected
INFO 16:50:06,253 [ActiveMQ Session Task] RadarServer: Got remote request
GetRadarStatusMessages(null)
INFO 16:50:10,548 [TCM Read kdix #2] RadarServer: kdix: message code=2
size=200 opMode=storm vcp=21 cuts=[5, 15, 24, 34, 43, 60, 99] rdaOp=online
rdaStat=operate rdaAlarm= dte=refl,vel,sw,dual-pol rpgOp=online
rpgStat=operate rpgAlarm=none avail=avail rdaVer=14.0 rpgVer=14.1
```

- Then the RPS List is sent:

```
INFO 16:50:10,694 [TCM Read kdix #2] RadarServer: kdix: Sending RPS list with
65 entries (65 requests)
```

- Then you should see the flow of data begin:

```
INFO 16:51:15,357 [TCM Read kdix #2] RadarServer: kdix: message code=94
size=5520 elev=2.5 sequence=2147 vs=2014-12-11 17:03:51 #67
```

- If you are sending the data to the WAN, you will then see a call to msg\_send:

```
INFO 16:51:15,357 [TCM Read kdix #2] RadarServer: Sending kdix code=94
header=SDUS24 KLWX 111703 / N2QDIX (matched prodList)
INFO 16:51:15,357 [Thread-13] RadarServer: Running [/awips/ops/bin/msg_send,
-c, 0, -p, 1, -e, /tmp/rcm5212925225564643269.tmp, -a, DEFAULTNCF
```

- Then the message is stored (if data is not being sent, then you will see the first message above followed immediately by the message below, skipping the prodList and msg\_send messages):

```
INFO 16:51:15,363 [TCM Read kdix #2] RadarServer: Stored message in
/data_store/radar/kdix/Z/elev2_4/res1/level256/kdix.94.20141211_1703
```

- A successful disconnect will look like the following:

```
INFO 16:53:46,653 [ActiveMQ Session Task] RadarServer: Got remote request
SetRadarConfig(kdix)
INFO 16:53:46,660 [ActiveMQ Session Task] RadarServer: Configuration saved
INFO 16:53:46,662 [ActiveMQ Session Task] RadarServer: kdix: disconnected
INFO 16:53:49,213 [ActiveMQ Session Task] RadarServer: Got remote request
SetRadarConfig(kdix)
INFO 16:53:49,221 [ActiveMQ Session Task] RadarServer: Configuration saved
INFO 16:53:49,228 [ActiveMQ Session Task] RadarServer: Got remote request
GetRadarConfig(null)
INFO 16:53:49,254 [ActiveMQ Session Task] RadarServer: Got remote request
GetRadarStatusMessages(null)
INFO 16:53:55,765 [ActiveMQ Session Task] RadarServer: Got remote request
SetRadarConfig(kdix)
INFO 16:53:55,773 [ActiveMQ Session Task] RadarServer: Configuration saved
```

- All of the message above are related to the steps taken to not only disable the radar, but then to repurpose for dial backup and then enable for OTR/RMR. Each time a change is made to the configuration, the dx1f:/awips2/rcm/data/config/persist/config.xml is changed accordingly.

## **Chapter 7**

# **Ingest of Radar Data**

## Chapter 7. Ingest of Radar Data

### Table of Contents

	<i>Page</i>
7.1 Overview .....	1
7.2 Radar Ingest Operation .....	5
7.2.1 SBN Radar Ingest Operation.....	5
7.2.2 ORPG Radar Ingest Operation.....	5
7.3 Data Archiving.....	5
7.3.1 Radar Archive Structure.....	8
7.3.1.1 Available SBN Radar Site Identifiers .....	9
7.3.1.2 Available ORPG Radar Site Identifiers.....	10
7.3.1.3 Available SBN Product Categories .....	11
7.3.1.4 Available ORPG Product Categories .....	11
7.3.2 EDEX Ingest Radar Data Logging.....	12
7.3.2.1 Radar Server Logs.....	13
7.3.2.2 Configuring Radar Server Logging.....	14
7.3.3 SBN Radar Configuration Files .....	15
7.3.3.1 SBN Radar Configuration Files – LDM.....	15
7.3.3.2 SBN Radar Configuration Files – PQACT .....	15
7.3.3.3 SBN Radar Configuration Files – EDEX Data Distribution Files .....	16
7.3.4 ORPG Radar Configuration Files .....	17
7.3.4.1 ORPG Radar Configuration Files – Radar Server.....	17
7.3.4.2 ORPG Radar Configuration Files – EDEX Data Distribution files .....	19
7.3.5 Storing Decoded SBN Radar Data.....	19
7.3.5.1 AWIPS II Metadata Database – Radar Metadata .....	20
7.3.5.2 AWIPS II Data Store – Radar Products .....	20
7.3.6 Audible Radar-Alerting.....	21
7.4 WAN/SBN Radar Product Distribution from Site to NCF.....	24
7.5 RPS list .....	28
7.6 Two-Way Communication.....	32
7.7 Central Collection Cron Schedule .....	34

### List of Exhibits

Exhibit 7.1-1. Radar Ingest Data Flow .....	2
Exhibit 7.2.1-1. Acquire and Ingest of Radar Products .....	7
Exhibit 7.3.6-1. Alert Visualization Configuration dialog .....	21
Exhibit 7.3.6-2. Alert Visualization Configuration Sources & Priorities .....	22
Exhibit 7.3.6-3. Alert Visualization Configuration Sources & Priorities Audio .....	23

Exhibit 7.3.6-4. Alert Visualization Configuration Sources & Priorities Audio File.....	23
Exhibit 7.3.6-5. Alert Visualization Configuration List .....	24
Exhibit 7.5-1. RPS List Editor .....	29
Exhibit 7.5-2. RPS List Editor View Menu – Select List .....	30
Exhibit 7.5-3. RPS List Editor View Menu List.....	31
Exhibit 7.5-3. RPS List Editor View Menu List Edit .....	31
Exhibit 7.6-1. Sending Environmental Data.....	33
Exhibit 7.6-2. Sending Radar Applications .....	34

### **List of Tables**

Table 7.4-1. WSR-88D Products on AWIPS.....	25
---	----

## 7.1 Overview

The AWIPS WSR-88D/TDWR radar data ingest is responsible for providing products to be sent and receiving centrally collected radar products over the SBN; requesting/receiving data from one or more associated ORPGs/SPGs; sending Radar Precipitation Bias Table to the ORPG; and making the data available to the AWIPS workstations. More specifically, the radar ingest system is responsible for initiating and maintaining connections with multiple ORPGs/SPGs, forwarding data requests from the workstations to the ORPGs/SPGs, receiving and processing data and status messages from the ORPGs/SPGs, and forwarding status messages to the workstations.

Two additional EDEX “tasks” are involved here. They are both are part of the EDEX RPG Environmental Data Service (rpgenvdata), and are triggered by Quartz timers. They are:

Send Environmental Data	Timer: Fires every hour on the hour
send Bias Table	Timer: Fires 26 and 46 minutes after each hour

Both tasks are managed by the EDEX Ingest Process on DX3 and DX4. The triggering mechanism is “clustered quartz”; this means that the event fires on both DX3 and DX4, but a locking mechanism is employed so that only one of the servers performs the work. Messages, status, error, etc., are logged to the EDEX Ingest process log (edex-ingest-yyyyymmdd.log); search for RPGEnvData. See Section 7.5 for detailed explanation.

SBN data is delivered via the Local Data Manager (LDM) on CPSBN (cp1f), and the locally collected radar data is delivered via the Radar Server on DX1/2.

Radar Ingest Data Flow is illustrated in the Exhibit 7.1-1. As shown in the exhibit, the data flow is a 12-step process. Descriptions of each step of the process follow.

1. Radar Data are received from two sources: The Radar Server on the DX1/2 cluster obtains radar data from the ORPG/SPG; and radar data obtained from the SBN is received from the LDM noaaportIngestor on the CP1/2 cluster. **Note:** RCM in the Exhibit 7.1-1 refers to Radar Coded Message, a specific kind of product generated by the RPG.
  - a. The Radar Server and the LDM noaaportIngestor write the product to a file on the Data Archive on NAS [NAS2]. (Refer to Section 7.1.)
  - b. The Radar Server and LDM post their messages containing product information to the QPID Message
  - c. The LDM writer instance uses the EDEX Bridge to post a message containing product information to the QPID Message Broker. The product information is the WMO header and the path to the product file.

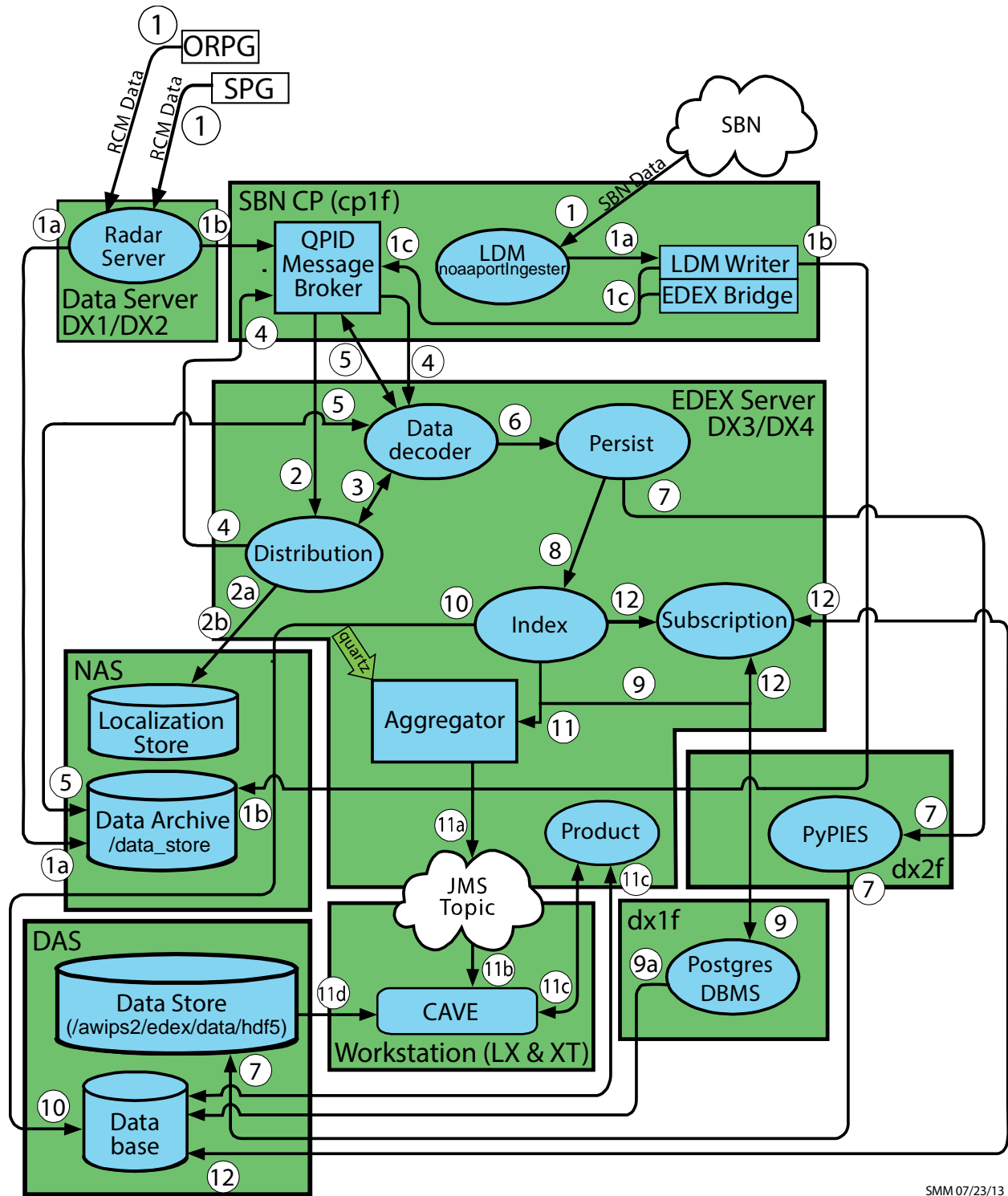

SMM 07/23/13

Exhibit 7.1-1. Radar Ingest Data Flow

2. The EDEX Distribution endpoint obtains the WMO (World Meteorological Organization) header for the product file identified by the message. The WMO header is matched against data distribution mappings contained in the data distribution directory to determine product routing. (The WMO header is usually included in the message; if it is not, the Distribution service uses the product file name from the message to determine routing.)

**NOTE:** The files in the data distribution directory are XML (eXtensible Markup Language) files that contain regular expressions which match WMO headers with the appropriate data decoder plug-in.

- a. At EDEX startup, the EDEX Distribution endpoint reads the Data Distribution files from the Data Distribution directory in the Localization Store. It uses the contents of these files to generate the routing table used to determine data routing. The Data Distribution directory is located at `/awips2/edex/data/utility/edex_static/base/distribution`.
  - b. The EDEX Distribution endpoint monitors the Data Distribution directory; when a file in that directory is modified, it rereads that file and rebuilds its routing table.
3. The EDEX Distribution Service determines the Data Decoder Plug-In registered to handle the data in the product file.
  4. The EDEX Distribution Service forwards the message to the appropriate Data Decoder Plug-In via the QPID Message Broker.
  5. The EDEX Data Decoder Service on the EDEX (DX) cluster pulls the message from the QPID Message broker. The Data Decoder Service reads the file pointed to by the message, decodes the data, and determines the appropriate metadata.
  6. The decoded data and metadata are sent to the EDEX Persist endpoint.
  7. The EDEX Persist endpoint sends the data to PyPIES and PyPies writes the data to the EDEX data store in HDF5 format.
  8. The EDEX Persist endpoint sends the metadata obtained to the EDEX Index endpoint.
  9. The EDEX Index endpoint sends the metadata to the PostgreSQL DBMS. The PostgreSQL DBMS writes the metadata to the database.
  10. The index endpoint does not merely get the dataURI. It also persists the data object to the database. Persistence to the database is executed via a plug-in defined data access object. If the data access object does not override the persistence behavior, then a default persistence strategy is used. The default strategy for persisting data to the database is to first check to see if the data received already exists. If it already exists, then persistence to the database is not attempted for that data. If the data is unique, then it is persisted to the database.



11. (Client notification) The Data URI is forwarded to the EDEX URI Aggregator.

Every 5 seconds the aggregated Data URIs are sent to the JMS Alert Topic.

CAVE monitors the JMS Alert Topic to obtain a list of available data. CAVE determines if it should render the available data.

CAVE retrieves metadata from the EDEX server via a product query sent to the EDEX Thrift endpoint.

CAVE retrieves product data from the EDEX server by accessing the EDEX data store's HDF5 files and CAVE renders the data, updating its display as appropriate.

12. (Subscription) The Data URI is forwarded to the EDEX Subscription endpoint.

The EDEX Subscription endpoint checks the active subscription list to determine if a subscription has been registered for the product.

If no subscription has been registered for the product, no further action is taken.

The EDEX Subscription endpoint obtains the script information from the database.

The EDEX Subscription endpoint obtains a micro-engine to execute the script. The micro-engine executes the subscription script for the product.

The Radar Server manages the following types of requests (please note that the forecaster interaction is via the CAVE Radar menu):

- Routine Product Set (RPS) list
- One-Time Request (OTR)
- Alert request
- Radar Multiple Request (RMR)
- Centrally collected radar products
- Radar Precipitation Bias Table.

The **RPS list** contains the products to be sent routinely to the workstation and the products to be centrally collected for transmission over the SBN. The list is sent to the ORPG/SPG on system start-up, when the radar mode changes, or when a forecaster at the workstation modifies one of the adaption RPS lists and sends it to the ORPG/SPG. An RPS list sent to an ORPG/SPG contains both a national and a local component if a site is identified as the office responsible for the national collection and distribution of radar data. National products take precedence over local products.

The **OTR** enables a forecaster at the workstation to request that a product be sent on a one-time basis only. When requesting data from a dedicated radar, the forecaster can also request that the product be sent for more than one volume scan. The request is terminated when it has been completed.

An alert request is generated at the workstation when the forecaster wants to be notified of an alert condition. When the threshold values specified in the request are exceeded, the

ORPG sends an alert message. The forecaster can also request that a product be provided along with the alert.

The RMR enables a forecaster at the workstation to request a single product (like an OTR) or a package of products, schedule requests for products at a specified frequency, and/or request products from any number of dedicated and dial-out ORPGs/SPGs.<sup>1</sup>

The NCF sends centrally collected radar products to all AWIPS sites over the SBN. Specified sites are tasked to collect and send certain products to the NCF via the WAN.

**Radar Precipitation Bias Tables** are available for transmission from AWIPS to an interested receiving ORPG site.

The new Radar Server takes the place of the following AWIPS I processes.

- RadarServer
- DialServer
- ORPGCommsMgr
- ORPGReqMgr.

## 7.2 *Radar Ingest Operation*

### 7.2.1 *SBN Radar Ingest Operation*

SBN data is delivered via the Local Data Manager (LDM) on CPSBN (cp1f), and the locally collected radar data is delivered via the Radar Server on DX1/2. SBN radar product ingest is performed by the EDEX Ingest processes on DX3 and DX4. EDEX operation is controlled by the edex\_camel service script located in /etc/init.d on DX3 and DX4.

### 7.2.2 *ORPG Radar Ingest Operation*

As illustrated in Exhibit 7.2.1-1, ORPG radar product ingest is controlled by the AWIPS II Radar Server, which is installed on the DX1/2 cluster. The Radar Server is controlled by the edex\_rcm service script located in /etc/init.d on DX1 and DX2.

## 7.3 *Data Archiving*

Radar products are written to the Data Archive in three separate locations:

- SBN radar products are written to /data\_store/radar/<YYYYMMDD>/<HH>/XXXX where XXXX is an uppercase, four- or three-character radar site identifier

---

<sup>1</sup> For information on how to perform on OTR, see Section 8.3 of the AWIPS II CAVE-D2D User's Manual (UM). Also see UM Section 8.1 for information on configuring an alert request and UM Section 8.4 for information on how to perform an RMR.

(customizable via the LDM).

- ORPG radar products are written to `/data_store/radar/xxxx` where `xxxx` is the lowercase, four-character radar site identifier.

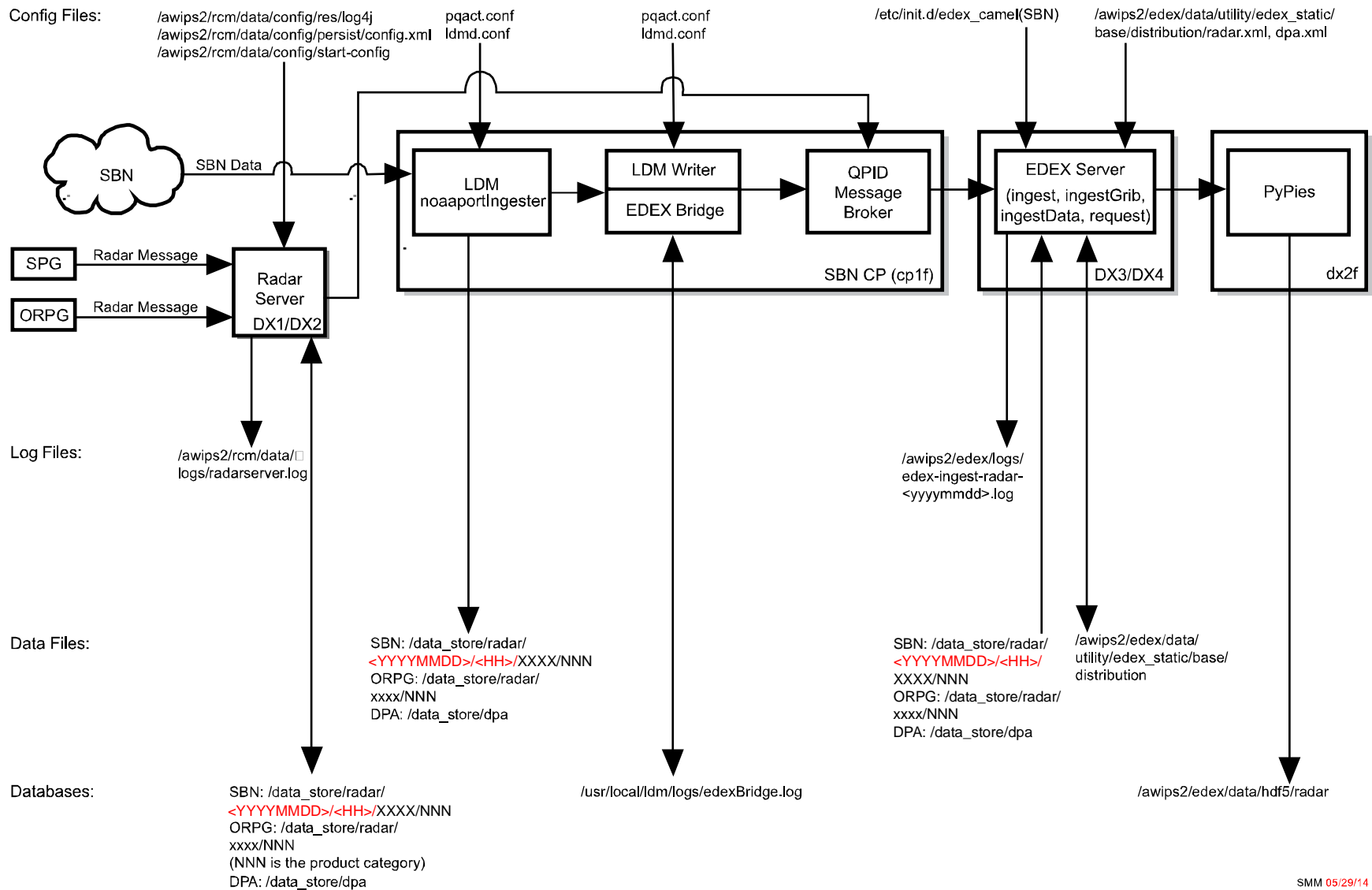

Exhibit 7.2.1-1. Acquire and Ingest of Radar Products

- Digital Precipitation Array (DPA) data is potentially stored in both the SBN and the ORPG data sections. At this point, the SBN stores a subset of the radar data it receives into /data\_store/dpa. This is the “DPA” data, which is used by the DPA process in EDEX. Because the DPA has been Rehosted (rather than rewritten), the options for placing the data were limited. In essence, the path (below /data\_store) to the data was built into the software being rehosted. DPA products are written to /data\_store/dpa and /data\_store/radar.

The raw data is stored in the Data Archive. The physical directory (/data\_store) is on the NAS. All the hosts mount the volume off NAS. [**Note:** The data\_store volume is moved off the DAS (dx2 direct mount; export via nfs to all hosts) and onto NAS.]

### 7.3.1 Radar Archive Structure

#### SBN Radar Products

The general structure of the SBN radar product archive is determined by the header information on the radar products. For radar data, the archive structure is

```
/data_store/radar/<YYYYMMDD>/<HH>/KXXX/NNN
```

and the files are named:

```
<RadarName>_NNN_<Radar_Volume_Scan_Time>_SDUS51_XXXX_seque  
nce.rad.<YYYYMMDDHH>
```

Where,

NNN ⇔ the product category

Radar\_Volume\_Scan\_Time: This is taken from the WMO heading. **Note:** In some products (GSMs), it is the message time.

SDUSii ⇔ product identifier

XXXX ⇔ product originator (transmitting wfo identifier – this is customizable via the LDM)

YYYYMMDDHH ⇔ the product time stamp

LDM assigns the sequence number. Its design minimizes the likelihood of file overwrites.

#### ORPG Radar Products

ORPG Radar products are written to the Data Archive in directories under /data\_store/radar. Each site that the Radar Server is configured for has a single directory at this level. (The directory’s name is the radar site identifier in lower case. Technically, however, it does not have to be lower case; it could be in either case.) Each site directory contains several subdirectories; each of these subdirectories is the mnemonic of the products in the directory. Under each product mnemonic, products are organized into

product-dependent structures. Subdirectories are generally self-explanatory. Three common directory structure patterns in the Radar Server Data Store are

```
/data_store/radar/<site>/<mnemonic>/<elevation>/<resolution>/<level>
```

Where `site` is the radar site and `mnemonic` is the product mnemonic.

```
E.g., /data_store/radar/tbwi/Z/elev19_5/res0_15/level256
/data_store/radar/<site>/<mnemonic>/<elevation>/<resolution>/<az>/<level>
```

```
E.g., data_store/radar/kgrr/Z/elev1_5/res0_25/az0_5/level256/
/data_store/radar/<site>/<mnemonic>/<layer>/<resolution>/<level>
```

```
E.g., /data_store/radar/tbwi/CZ/layer0/res1/level16
```

The exact directory structure used by the Radar Server is determined by the Radar Server software and is unchanged from AWIPS 1 and it's preserved primarily to support FSI.

### DPA Products

DPA Products are stored in the same way as other SBN or ORPG products.

#### 7.3.1.1 Available SBN Radar Site Identifiers

The list of potential radar sites available in the Data Archive depends on the configuration of the LDM and the EDEX Distribution Service. It is possible to query the Data Archive to determine available site identifiers. This query is performed using a command line script; the script can run on any workstation with access to the Data Archive.

Enter the following command in a console window or x-term:

```
TYPE:      cd /data_store/radar/<YYYYMMDD>/<HH>
```

```
TYPE:      ls | grep -P "[A-Z]"
```

```
KBGM
```

```
KABX
```

```
KAMA
```

```
KBLX
```

```
KCYS
```

```
KDAL
```

```
KDDC
```

```
KDFW
```

```
KDFX
```

```
KDYX
```

```
KEWX
```

```
KFDX
```

KFSX  
KFWS  
KGJX  
KGLD  
KGRK  
KICH  
KICT  
KICX  
KINX  
KIWA  
KLBB  
KLNX  
KMTX  
KPHX  
KPUX  
KSGF  
KSHV  
KSJT  
KSLC  
KSRX  
KTLX  
KTUL  
KTWX  
KUEX  
KVNX  
KYUX

**NOTE:** This procedure provides a list of radar sites from which Radar Data has been received over the SBN. It does not provide a list of current sites or current data.

### 7.3.1.2 Available ORPG Radar Site Identifiers

The list of ORPG radar sites available for the Radar Server depends on the configuration of the Radar Server and the EDEX Distribution Service. It is possible to query the Data Archive to determine available site identifiers. This query is performed using a command line script that may be performed from any workstation with access to the Data Archive.

Enter the following commands in a console window or X-Term:

```
TYPE:      cd /data_store/radar
TYPE:      ls | grep -P "^[a-z]{4}$" > ~/radar-sites.txt
TYPE:      sort ~/radar-sites.txt > ~/sorted-radar-sites.txt
```

```
TYPE:    cat ~/sorted-radar-sites.txt | tr [:cntrl:] ' : '
           > ~/radar-sites.txt
```

```
TYPE:    cat ~/radar-sites.txt ; echo
           koax
```

### 7.3.1.3 Available SBN Product Categories

The list of Product Categories available in the Data Archive will depend on the configuration of the LDM and the EDEX distribution server. It may also vary from radar site to radar site. It is possible to query the Data Archive to get a rough list of available product categories. This query is performed using a command line script; the script may be performed from any workstation with access to the Data Archive.

Enter the following commands in a console window or X-Term:

```
TYPE:    cd /data_store/radar/<YYYYMMDD>/<HH>/KXXX
```

```
TYPE:    echo $( for i in $(ls | grep -E "[A-Z]{4}$"); do
                 ls "$i"; done | sort | uniq)      (all on one line)
```

```
DAA DPR DU3 NOC NOQ NOV N1H N1Q N2C N2Q N3C N3Q NCR NVW
DHR DSD DVL N0H N0R N0X N1K N1S N2H N2S N3H N3S NET OHA
DOD DSP EET N0K N0S N0Z N1M N1U N2K N2U N3K N3U NTP PTA
DPA DTA HHC N0M N0U N1C N1P N1X N2M N2X N3M N3X NVL
```

**NOTE:** This procedure provides a list of product categories for Radar Data received over the SBN. It does not provide a list of current product categories or current data.

### 7.3.1.4 Available ORPG Product Categories

Product categories for a specific site may be determined by listing that site's directory in /data\_store/radar. To determine product categories available regardless of site, use the following script:

```
TYPE:    cd /data_store/radar
```

```
TYPE:    echo $( for i in $(ls | grep -E "[a-z]{4}$"); do
                 ls "$i"; done | sort | uniq)      (all on one line)
```

```
AAP APR CFC CZ DHR DMD DPA DUA DVL EET ET GSM HI LRM MD OHP OSD OSW PRR
PTL RCM RSS SO SPD SRM SS SSD SSW STI STP SW THP TRU TVS ULR V VIL VWP Z
```



**NOTE:** This procedure provides a list of product categories for Radar Data received over the SBN. It does not provide a list of current product categories or current data.

### 7.3.2 EDEX Ingest Radar Data Logging

Radar Ingest processing follows the same general strategy for logging as the remaining data decoders; both routine messages and error messages are logged to the EDEX process logs. The process logs are located in /awips2/edex/logs on each of the EDEX servers, DX3 and DX4. The logs to examine are the EDEX Ingest process log and the EDEX Radar Ingest process log.

**Note:** The EDEX Ingest process logs contain startup messages and most other messages, including errors, for the EDEX processes. The EDEX Radar Ingest process log contains messages relating to a radar type. These include both status messages and error messages.

To monitor basic EDEX ingest, log into either DX3 or DX4 and change the directory to /awips2/edex/logs.

**TYPE:**        `tail -f edex-ingest-yyyymmdd.log`

where yyyymmdd is the date stamp of the current log file.

To monitor messages specific to Radar Product ingest, log into either DX3 or DX4 and change directory to /awips2/edex/logs.

**TYPE:**        `tail -f edex-ingest-radar-yyyymmdd.log`

where yyyymmdd is the date stamp of the current log file.

The LDM writer uses patterns to determine where to write data files, including the path and file name. A typical entry is something like this and it is created by the config\_awips2.sh script.

```

NNEXRAD ^(SDUS[234578].|NXUS6.)
(K|P|T)(OUN|AMA|FWD|DDC|SJT|GLD|GID|LZK|LUB|EWX|SHV|SGF|TOP|TSA|IC
T)(...)(...)(...) /p(...)(...)
      FILE      -overwrite -log -close -edex
/data_store/radar/(\4:yyyy)(\4:mm)\4/\5/\2\8/\7/\2\8_\7_\4\5\6-
\1_\2\3_(seq).rad.%Y%m%d%H

```

Log entry similar is shown below.

```

INFO 2014-05-19 00:00:11,320 [Ingest.Radar-1] Ingest: EDEX:
Ingest - radar-sbn::
/data_store/radar/20140518/23/KBGM/N2C/KBGM_N2C_182337-
SDUS81_KBGM_43526953.rad.2014051900 processed in: 0.0510
(sec) Latency: 2.1520 (sec)

```

The number before the ".rad" (43526953 in this case) is set by the LDM and can be traced from EDEX. These sequence numbers (product identifiers) can be traced to the LDM logs on the cpsbn2 (goes.log, nwstg.log, etc.) in /data/lm/logs.

**NOTE:** For additional information on monitoring EDEX and EDEX based ingest operations, see Chapter 25.

### 7.3.2.1 Radar Server Logs

The Radar Server also maintains its own logging. Radar Server logs are located in `/awips2/rcm/data/logs`. The current Radar Server log is `radarserver.log`. In normal conditions, the Radar Server creates a new log file daily and retains up to 3 old logs. Old logs are named `radarserver.log.yyyy-mm-dd`.

To monitor basic Radar Server operation, log onto the active member of the DX1/2 cluster and change directory to `/awips2/rcm/data/logs`.

**TYPE:**        `tail -f radarserver.log`.

The basic structure of the Radar Server is the same as the EDEX logging. Routine messages fit one of two patterns:

**INFO <time-stamp> [thread] RadarServer: Stored <message>**

```
INFO 00:00:04,914 [TCM Read kbox #2] RadarServer: kbox:
message code=99 size=68294 elev=0.9 sequence=17216 vs=2014-
05-19 00:01:44 #35
```

**INFO <time-stamp> [thread] RadarServer: <site>: <message>**

```
INFO 00:00:10,200 [TCM Read kbox #2] RadarServer: Stored
message in
/data_store/radar/kbox/V/elev0_9/res0_15/level256/kbox.99.20
140519_0001
```

These messages will normally occur in pairs. These patterns can be used to perform a quick status check on the Radar Server.

To monitor product arrival for a specific site, log onto the active member of the DX1/2 cluster and change directory to `/awips2/rcm/data/logs`. Once in that directory,

**TYPE:**        `tail -f radarserver.log | grep "RadarServer: <site>:"`

(replace `<site>` with the site identifier)

To monitor Radar Server writes, log onto the active member of the DX1/2 cluster and change directory to `/awips2/rcm/data/logs`. Once in that directory,

**TYPE:**        `tail -f radarserver.log | grep "RadarServer: Stored"`

### 7.3.2.2 Configuring Radar Server Logging

Radar Server logging is controlled by a file called `log4j.properties` which is located in `/awips2/rcm/data/config/res` on each server in the DX1/2 cluster.

Unlike EDEX configuration files, this directory is not shared between the servers, so any desired changes will need to be made on both servers. The baseline version of `log4j.properties` for the Radar Server contains the following entries.

```
log4j.rootLogger=INFO, rolling
log4j.logger.RadarServer=INFO, rolling
log4j.additivity.RadarServer=false
log4j.appender.console=org.apache.log4j.ConsoleAppender
log4j.appender.console.layout=org.apache.log4j.PatternLayout
log4j.appender.console.layout.ConversionPattern=%-5p %d [%t] %c{1}: %m%n
log4j.appender.rolling=com.raytheon.rcm.server.DailyPurgingRollingFileAppender
log4j.appender.rolling.layout=org.apache.log4j.PatternLayout
log4j.appender.rolling.layout.ConversionPattern=%-5p %d{HH:mm:ss,SSS} [%t] %c{1}: %m%n
log4j.appender.rolling.File=${com.raytheon.rcm.logDir}/radarserver.log
log4j.appender.rolling.DatePattern='.'yyyy-MM-dd
log4j.appender.rolling.MaxFiles=3
```

#### Default log4j.properties for Radar Server

**NOTE:** Take extreme care in modifying this file; an error will cause logging and perhaps operational problems in the Radar Server. The only line that should be modified is the final one on the file: **log4j.appender.rolling.MaxFiles=3**

This line specifies the number of old logs to retain. Change the 3 to the desired number of old files. Then restart the Radar Server for the changes to take effect

The last line in the `log4j.properties` file specifies the number of old log files to keep. Log files are rolled daily, that is, a new log file is opened each day. Normally, as installed, three log files are retained. This means the current log file plus the previous two are retained. This also handles file purging – when the radar server is started, and each day thereafter, excess log files are deleted. For example, to retain a total of six old logs, change the final entry to "`log4j.appender.rolling.MaxFiles=6`".

**NOTE:** The only reason to change `log4j.properties` (a configuration file) is to change the number of old logs being retained. This file applies only to the AWIPS II Radar Server, the application that bridges AWIPS II EDEX Ingest and the ORPG. It is located at `/awips2/rcm/data/config/res` on DX1 and DX2. Configuration files located in `/awips2/edex/conf` on both DX 3 and DX4 control all other EDEX process logging. These files are `log4j.xml` and `log4j-ingest.xml`. Any changes related to logging of other data types must be made in these files. Two caveats: 1) Each server (DX3/DX4) holds a copy of each of these logs. Changes made to one of these files on one server must be propagated to the other. The changes are read only at EDEX startup. 2) These are XML files, which can be sensitive to errors. Edits made to these files can cause malformed XML, which could cause logging issues. It does not appear to cause EDEX to quit, but there are startup issues, and, depending on where the XML error occurs, logging can be affected. Most changes to the EDEX logging strategy need to be made to one or both of these files, but this is not recommended.

### 7.3.3 SBN Radar Configuration Files

There are two types of Radar Configuration Files: 1) the LDM PQACT files; and 2) EDEX Distribution Service files.

#### 7.3.3.1 SBN Radar Configuration Files – LDM

LDM server runs only on the SBN CP. It ingests everything from the SBN.

LDM behavior is controlled by the `pqact.conf` file, and the patterns are matched against **pqact.conf**. LDM writes the product to `data_store` and posts a QPID message.

- **pqact.conf** controls how data sent to an instance of LDM is handled. This includes the data types to be handled and the location of the raw data archive.

**NOTE:** Modifying `pqact.conf` will have a severe impact on the data flow.

#### 7.3.3.2 SBN Radar Configuration Files – PQACT

Radar data flow is archived into two separate areas: radar products and Digital Precipitation Array (DPA) products. In general, LDM writes radar products to directories under `/data_store/radar` and DPA products under `/data_store/dpa`.

This is an example of what is being generated by `config_awips2.sh`:

```

NNEXRAD ^(SDUS[234578].|NXUS6.)
(K|P|T)(OUN|AMA|FWD|DDC|SJT|GLD|GID|LZK|LUB|EWX|SHV|SGF|TOP|TSA|ICT)
(..)(..)(..) /p(...)(...)

```

```
FILE -overwrite -log -close -edex
/data_store/radar/(\4:yyyy)(\4:mm)\4\5\2\8\7\2\8_\7_\4\5\6-
\1_\2\3_(seq).rad.%Y%m%d%H
```

The first part, NNEXRAD, is the FEEDTYPE.

The Regular Expression describes any product starting with SDUS and follows with any number between 2 and 8 OR starting with NXUS6.

The () store that string into the variable \1, which can be used when storing to physical disk.

(K|P|T) matches either a K, P or T and stores that to the variable \2 .

(OUN|AMA|FWD|DDC|SJT|GLD|GID|LZK|LUB|EWX|SHV|SGF|TOP|TSA|ICT) matches any of those site IDs and stores it to variable \3 .

(.)(.)(.) matches the next 6 characters of any type and stores them in pairs to \4, \5, and \6 respectively.

/p matches the exact string /p

(...)(...) matches the next 6 characters of any type and stores them in trios to \7 and \8 .

#### Product:

```
NEXRAD3 56424268 SDUS51 KLWX 211529 /pTZLDCA !nids/
```

#### Storage Location:

```
/data_store/radar/<YYYYMMDD>/<HH>/KDCA/TZL/1529_KDCA_TZL_56424268
.rad
```

**For DPA products**, the pattern is nearly identical. In this case, only DPA products are matched, so the NNN entry is hard coded as DPA.

### 7.3.3.3 SBN Radar Configuration Files – EDEX Data Distribution Files

In addition to the configuration files that control the LDM, the EDEX ingest subsystem uses a set of configuration files to determine which decoder(s) will handle the data. These files are initially installed with EDEX; once EDEX has been started, they are located in the AWIPS II localization store in /awips2/edex/data/utility/edex\_static/base/distribution. (Recall that to access the localization store, you log onto DX3.)

The files in /awips2/edex/data/utility/edex\_static/base/distribution contain acceptance patterns for each decoder. As a general rule, the files are named <data type>.xml. For radar data, the file is radar.xml; for DPA data, the file is dpa.xml. Here is a sample version of the radar.xml file.

```
<requestPatterns >
  <regex>^SDUS[234578]. .*</regex>
```

```
<regex>^RadarServer.*</regex>
</requestPatterns>
```

Here is a sample version of the dpa.xml file.

```
<requestPatterns xmlns:ns2="group">
  <regex>^SDUS8. . . . _DPA*</regex>
  <regex>^SDUS5. .*</regex>
  <regex>^.{4}.81.*</regex>
  <regex>^RadarServer.*.81</regex>
```

SDUS\* entries support the SBN radar data; RadarServer entries support the ORPG ingest of local radars. Each <regex/> tag contains a Perl 5 style regular expression, which is matched against the WMO header of a data file; if the pattern matches, the decoder can handle the data in the file.

Both radar.xml and dpa.xml may be edited to change data acceptance rules for the Distribution Service. This is normally performed as part of the site localization.

**NOTE:** Use care in editing these files; malformed XML can result in a failure of the EDEX Ingest process to start.

### 7.3.4 ORPG Radar Configuration Files

There are two types of configuration files: Radar Server; and EDEX Data Distribution.

#### 7.3.4.1 ORPG Radar Configuration Files – Radar Server

The radar data flow is controlled via the RCM configuration files on DX1/2. The configuration files are located in the /awips2/rcm/data/config directory tree. Basic Radar Server operation is controlled by two configuration files:

- **Start-config.** Contains basic information required for Radar Server operation. It is initialized by the AWIPS II installer; it should not be modified.
- **config.xml.** Contains configuration information defining data flow. It is located in /awips2/rcm/data/config/persist. It may be modified to change the list of radars being processed by the Radar Server. ORPG Radar Configuration Files – config.xml.

**config.xml** provides basic information the Radar Server uses to communicate with the rest of AWIPS. The basic format of config.xml is shown in the sample file on the following page; it shows two radars being accessed via Radar Server – koax and ktlx.

```

<?xml version="1.0" encoding="UTF-8" standalone="yes"?>
<config>
  <pupID>614</pupID>
  <regionCode>3</regionCode>
  <wmoSiteID>KOAX</wmoSiteID>
  <collectionEnabled>true</collectionEnabled>
  <tdwrCollectionLimited>true</tdwrCollectionLimited>
  <decompressProducts>true</decompressProducts>
  <edexEndpoint>/awips2/edex/data/sbn/radar</edexEndpoint>
  <endpointConfig>
    <archiveRoot>/data_store/radar</archiveRoot>

  <connectionURL>amqp://guest:guest@/edex?brokerlist='tcp://cplf:5672'</connectionURL>
    <prefixPathWithRadar>false</prefixPathWithRadar>
    <topic>radarserver.dropbox</topic>
  </endpointConfig>
  <radars>
    <radar>
      <radarID>kbox</radarID>
      <nexradID>323</nexradID>
      <enabled>true</enabled>
      <dedicated>true</dedicated>
      <collectionEnabled>true</collectionEnabled>
    <sendEnvironmentalData>true</sendEnvironmentalData>
    <linkType>TCP_WAN</linkType>
    <links>
      <link>
        <dedicated>true</dedicated>
        <!-- linkAddress>165.92.24.75:4490</linkAddress -->
        <linkAddress>165.92.21.33:4490</linkAddress>
        <linkIndex>2</linkIndex>
        <linkType>TCP_WAN</linkType>
        <maxRpsListSize>150</maxRpsListSize>
        <tcmPassword>passwd</tcmPassword>
      </link>
    </links>
    <productAvailabilityFieldUsable>true</productAvailabilityFieldUsable>
  </radar>
  <radar>
    <radarID>tbwi</radarID>
    <nexradID>3005</nexradID>
    <enabled>false</enabled>
    <dedicated>true</dedicated>
    <collectionEnabled>false</collectionEnabled>
    <sendEnvironmentalData>true</sendEnvironmentalData>
    <linkType>TCP_WAN</linkType>
    <links>
      <link>
        <dedicated>true</dedicated>
        <linkAddress>165.92.21.77:4488</linkAddress>
        <linkIndex>2</linkIndex>
        <linkType>TCP_WAN</linkType>
        <maxRpsListSize>-1</maxRpsListSize>
        <portPassword>TCPP</portPassword>
        <tcmPassword>passwd</tcmPassword>
        <userPassword>PRCWIP</userPassword>
      </link>
    </links>
    <productAvailabilityFieldUsable>true</productAvailabilityFieldUsable>
  </radar>
</radars>
</config>

```

### Sample Radar Server config.xml

### 7.3.4.2 ORPG Radar Configuration Files – EDEX Data Distribution files

The EDEX ingest subsystem uses a set of configuration files to determine which decoder(s) will handle data. These files are initially installed with EDEX; once EDEX has been started, they are located in the AWIPS II localization store in `/awips2/edex/data/utility/edex_static/base/distribution`. (Recall that to access the localization store, you log onto DX3.)

The files in `/awips2/edex/data/utility/edex_static/base/distribution` contain acceptance patterns for each decoder. As a general rule, the files are named `<data type>.xml`. For data from the Radar Server, the file is `radar.xml`.

Typical contents of `radar.xml` are:

```
<requestPatterns xmlns:ns2="group">
  <regex>^SDUS[234578]. KABR.*</regex>
  <regex>^SDUS[234578]. KCYS.*</regex>
  <regex>^SDUS[234578]. KDMX.*</regex>
  <regex>^SDUS[234578]. KGLD.*</regex>
  <regex>^SDUS[234578]. KGID.*</regex>
  <regex>^SDUS[234578]. KEAX.*</regex>
  <regex>^SDUS[234578]. KARX.*</regex>
  <regex>^SDUS[234578]. KMPX.*</regex>
  <regex>^SDUS[234578]. KLBF.*</regex>
  <regex>^SDUS[234578]. KDVN.*</regex>
  <regex>^SDUS[234578]. KUNR.*</regex>
  <regex>^SDUS[234578]. KFSD.*</regex>
  <regex>^SDUS[234578]. KTOP.*</regex>
  <regex>^SDUS[234578]. PHFO.*</regex>
  <regex>^SDUS[234578]. PGUM.*</regex>
  <regex>^koax.*</regex>
  <regex>^RadarServer.*</regex>
</requestPatterns>
```

For the Radar Server, the key is the final `<regex/>` tag; this specifies that a message containing a header starting with “RadarServer” is to be routed to the radar decoder. This tag is normally present in `radar.xml` and should not be changed. If changed, EDEX will likely cease processing radar data from the Radar Server.

### 7.3.5 Storing Decoded Data

Decoded radar data is stored in two locations: the AWIPS II Data Store and the AWIPS II metadata database

- The AWIPS II Metadata Database is hosted in PostgreSQL on the DX 1/2 cluster. The Radar metadata is stored in the `radar` and `radar_spatial` table of the `awips` schema of the metadata database.
- Decoded radar products are stored in HDF5 files in the AWIPS II Data Store on `dx2f`.



### 7.3.5.1 AWIPS II Metadata Database – Radar Metadata

AWIPS II software uses a PostgreSQL database to store product metadata, i.e., data that helps to identify decoded data. Physically, the database resides on the PowerVault – DAS. The PostgreSQL database Server software runs on DX1/2 cluster.

For AWIPS II, metadata is stored in the awips schema of the metadata database. Radar metadata resides in two tables: radar and radar\_spatial.

The radar table is a dynamic table that includes an entry for each decoded radar product that is available on the AWIPS II system. The radar\_spatial table is a static table that contains spatial data relating to the radar sites.

When Radar Data has been successfully ingested, the radar records are written to HDF5 files in the AWIPS II Data Store, and then the metadata is written to the database. At that point, the decoded data is available to client applications such as CAVE.

### 7.3.5.2 AWIPS II Data Store – Radar Products

Processed radar products are written to the AWIPS II Data Store. On the dx2f, the AWIPS II Data Store is mapped to /awips2/edex/data/hdf5/radar/<site>/.

Under /awips2/edex/data/hdf5/<site>/, the decoded radar products are stored in the radar site subdirectory.

For example, under /awips2/edex/data/hdf5/radar/kakq

```

TYPE:      ls -l
drwxr-xr-x 2 awips awips 4096 Aug 15 16:28 0.0
drwxr-xr-x 2 awips awips 4096 Aug 15 16:28 0.5
drwxr-xr-x 2 awips awips 4096 Aug 15 16:28 0.9
drwxr-xr-x 2 awips awips 4096 Aug 15 16:28 10.0
drwxr-xr-x 2 awips awips 4096 Aug 15 16:28 12.0
drwxr-xr-x 2 awips awips 4096 Aug 15 16:28 14.0
drwxr-xr-x 2 awips awips 4096 Aug 15 16:28 1.5
drwxr-xr-x 2 awips awips 4096 Apr 17 16:04 16.7
drwxr-xr-x 2 awips awips 4096 Aug 15 16:28 1.8
drwxr-xr-x 2 awips awips 4096 Aug 15 16:28 19.5
drwxr-xr-x 2 awips awips 4096 Aug 15 16:28 2.4
drwxr-xr-x 2 awips awips 4096 Aug 15 16:28 3.4
drwxr-xr-x 2 awips awips 4096 Aug 15 16:28 4.3
drwxr-xr-x 2 awips awips 4096 Aug 15 16:28 5.3
drwxr-xr-x 2 awips awips 4096 Aug 15 16:28 6.0
drwxr-xr-x 2 awips awips 4096 Aug 15 16:28 7.5

```

**Under 0.0**

```
radar-kakq-2013-01-09-13.h5  radar-kakq-2013-02-13-14.h5
radar-kakq-2013-01-10-20.h5  radar-kakq-2013-02-13-15.h5
radar-kakq-2013-01-22-16.h5  radar-kakq-2013-02-13-16.h5
radar-kakq-2013-02-07-18.h5  radar-kakq-2013-02-13-17.h5
radar-kakq-2013-02-13-03.h5  radar-kakq-2013-02-13-18.h5
radar-kakq-2013-02-13-04.h5  radar-kakq-2013-02-13-19.h5
radar-kakq-2013-02-13-05.h5  radar-kakq-2013-02-13-20.h5
radar-kakq-2013-02-13-06.h5  radar-kakq-2013-02-13-21.h5
radar-kakq-2013-02-13-07.h5  radar-kakq-2013-02-13-22.h5
radar-kakq-2013-02-13-08.h5  radar-kakq-2013-02-13-23.h5
radar-kakq-2013-02-13-09.h5  radar-kakq-2013-02-14-00.h5
radar-kakq-2013-02-13-10.h5  radar-kakq-2013-02-14-01.h5
radar-kakq-2013-02-13-11.h5  radar-kakq-2013-02-14-02.h5
radar-kakq-2013-02-13-12.h5  radar-kakq-2013-02-14-03.h5
radar-kakq-2013-02-13-13.h5  radar-kakq-2013-02-14-04.h5
```

### 7.3.6 Audible Radar-Alerting

AlertVIZ includes the capability to use audible alerting of messages on workstations that have audio capabilities. Adding an audio component to Radar Alerts involves modifying the AlertVIZ configuration on the workstation. To do this, use the configuration dialogs built into AlertVIZ.

- a. Right click on the AlertVIZ icon in the system and select *Configuration*. This will display the Alert Visualization *Configuration dialog*. (See Exhibit 7.3.6-1.)

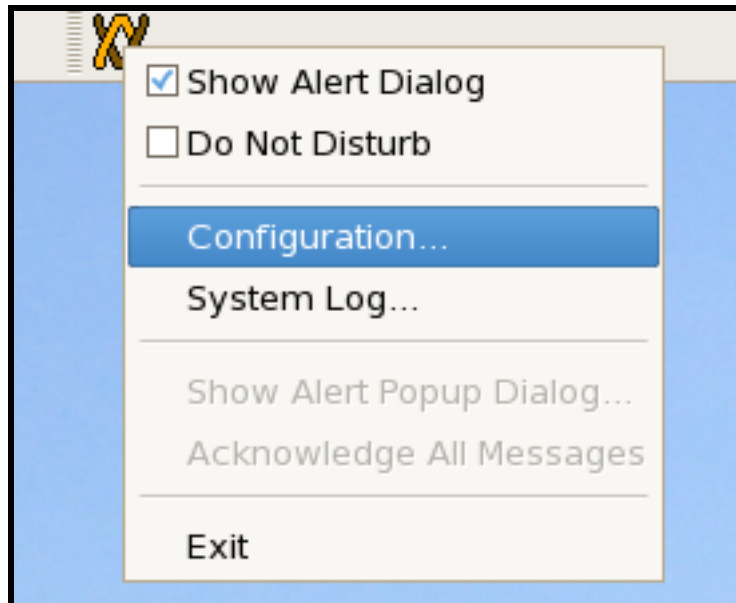
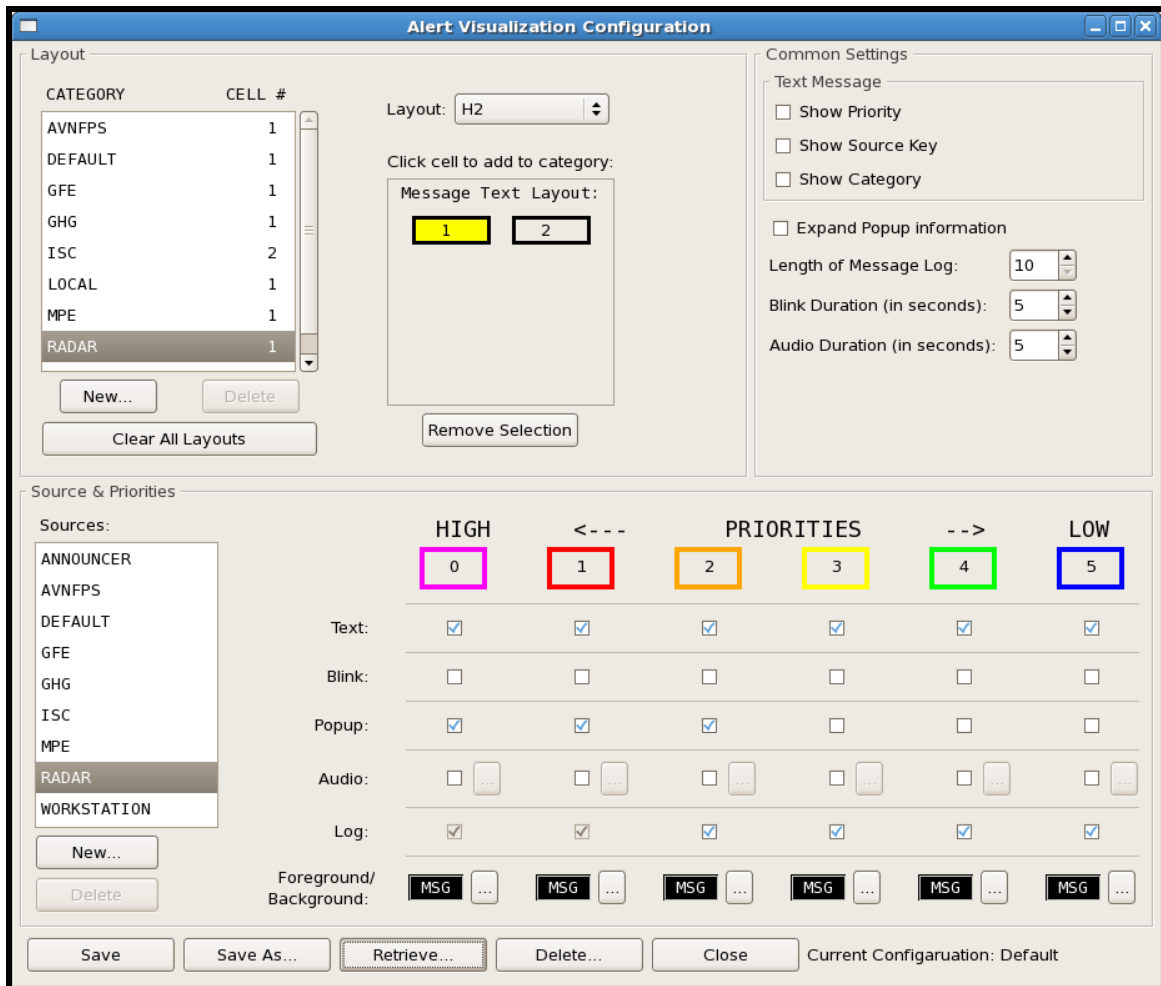

Exhibit 7.3.6-1. Alert Visualization Configuration dialog

- b. On the *Alert Visualization Configuration* dialog, select *RADAR* from the list box under *Sources & Priorities* at the lower left of the dialog. This will load the alerting information for *RADAR* into the lower control group. (See Exhibit 7.3.6-2).



**Exhibit 7.3.6-2. Alert Visualization Configuration Sources & Priorities**

- c. In the *Sources & Priorities* control group, make sure *RADAR* in the *Sources* menu is selected in the list box, and then click the *Audio* check box under *HIGH*. (See Exhibit 7.3.6-3.)



**Exhibit 7.3.6-3. Alert Visualization Configuration Sources & Priorities Audio**

- d. Selecting the *Audio* checkbox activates the *Audio* browse button. Click the *browse* button. This will display the *Audio File Selection* dialog. This dialog displays the currently available audio files. (See Exhibit 7.3.6-4.)

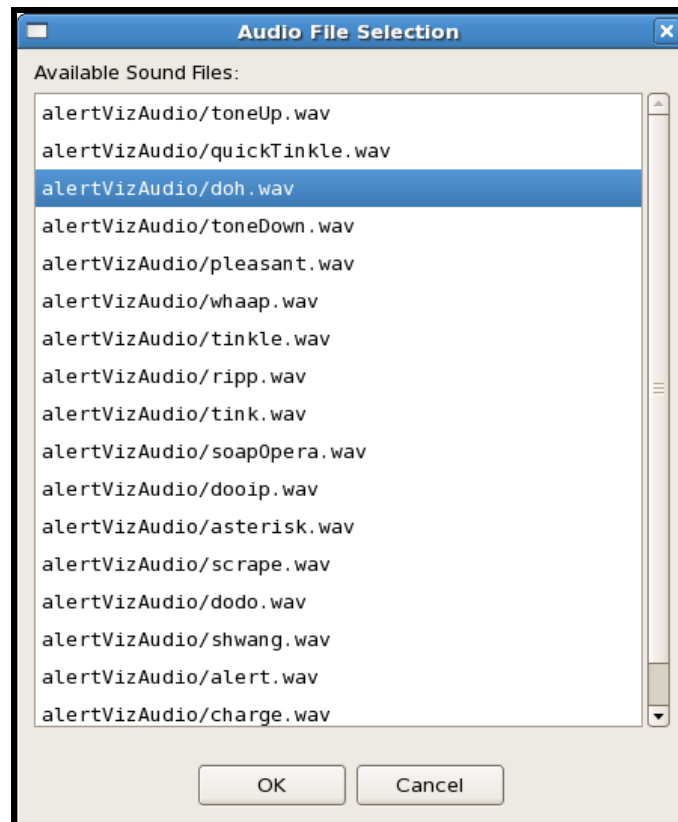

**Exhibit 7.3.6-4. Alert Visualization Configuration Sources & Priorities Audio File**

- e. Select desired sound file and click *OK*.

- f. To save the modification to the Alert VIZ configuration, click the *Save As ...* button at the bottom of the *Alert Visualization Configuration* dialog. This opens the *Configuration List* dialog in save mode. (See Exhibit 7.3.6-5.)

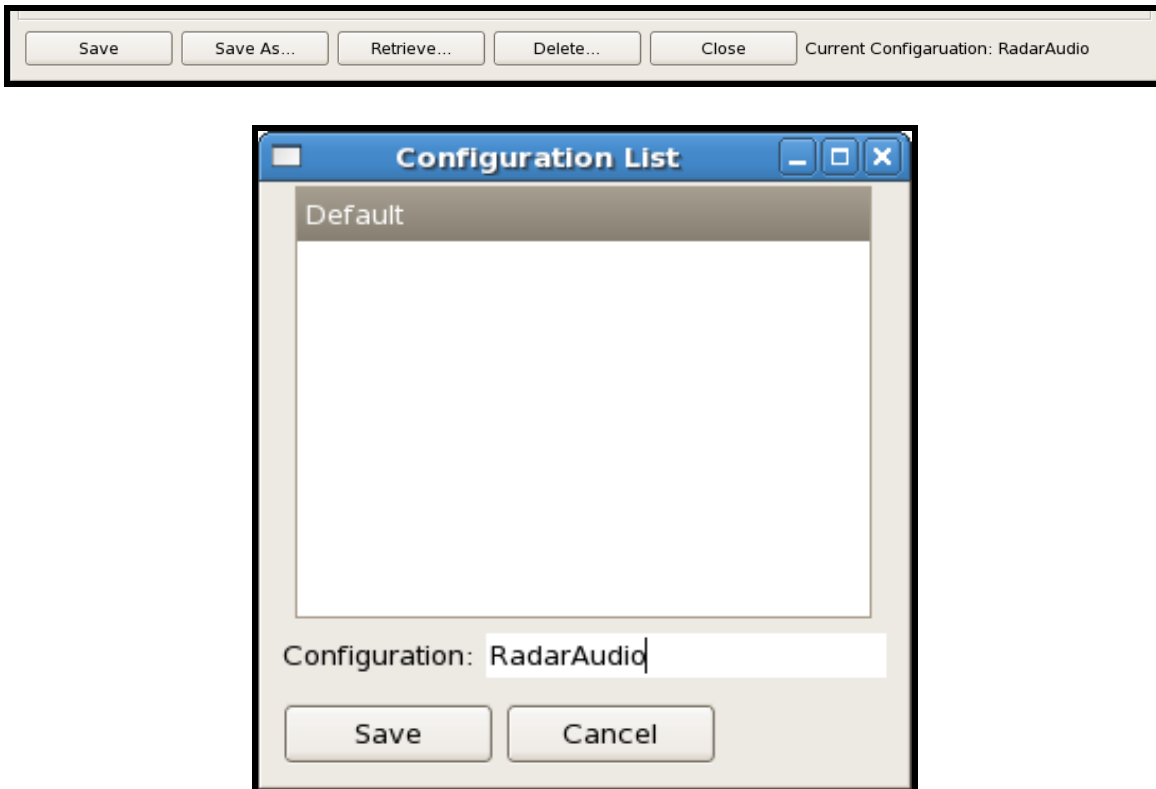

**Exhibit 7.3.6-5. Alert Visualization Configuration List**

- g. Once the dialog is open, enter a name for the configuration and click *Save*. The *Alert Visualization Configuration* dialog will update to show your new configuration as the current configuration.

Once the configuration has been changed, a restart of Alert VIZ will result in the new configuration being loaded.

Note that the new configuration is saved in the AWIPS-II data localization store for the current user. As a result, the newly updated configuration is available for that user on all workstations.

#### **7.4 WAN/SBN Radar Product Distribution from Site to NCF**

The AWIPS WAN/SBN distribution capability allows sites to distribute radar products over the WAN to the NCF for redistribution to all AWIPS sites over the SBN. Table 7.4-1 lists the product number and name, levels, layer, resolution and range, product ID, and format for WSR-88D products on AWIPS.

Table 7.4-1. WSR-88D Products on AWIPS

Prod Num	Lvls	Lyr	Resol	Range	Prod ID	Product Name	Format
2	0	0	0	0	GSM	General Status Msg (GSM)	GSM
3	0	0	0	0	PRR	Product Request Resp (PRR)	PRR
6	0	0	0	0	AAP	Alert Adaptation Parm (AAP)	AAP
8	0	0	0	0	PTL	Product List (PTL)	PTL
9	0	0	0	0	AM	Alert Message (AM)	AM
16	8	0	1	230	Z	Reflectivity (Z)	Radial
17	8	0	2	460	Z	Reflectivity (Z)	Radial
18	8	0	4	460	Z	Reflectivity (Z)	Radial
19	16	0	1	230	Z	Reflectivity (Z)	Radial
20	16	0	2	460	Z	Reflectivity (Z)	Radial
21	16	0	4	460	Z	Reflectivity (Z)	Radial
22	8	0	0.25	60	V	Velocity (V)	Radial
23	8	0	0.5	115	V	Velocity (V)	Radial
24	8	0	1	230	V	Velocity (V)	Radial
25	16	0	0.25	60	V	Velocity (V)	Radial
26	16	0	0.5	115	V	Velocity (V)	Radial
27	16	0	1	230	V	Velocity (V)	Radial
28	8	0	0.25	60	SW	Spectrum Width (SW)	Radial
29	8	0	0.5	115	SW	Spectrum Width (SW)	Radial
30	8	0	1	230	SW	Spectrum Width (SW)	Radial
31	16	0	2	230	USP	User Select Precip (USP)	Radial
32	256	0	1	115	DHR	Digital Hybrid Scan Refl (DHR)	Radial
33							
34	8	0	1	230	CFC	Clutter Filter Control (CFC)	Radial
35	8	0	1	230	CZ	Composite Ref (CZ)	Raster
36	8	0	4	460	CZ	Composite Ref (CZ)	Raster
37	16	0	1	230	CZ	Composite Ref (CZ)	Raster
38	16	0	4	460	CZ	Composite Ref (CZ)	Raster
39	0	0	1	230	CZC	Composite Ref Contour (CZC)	Graphic
40	0	0	4	460	CZC	Composite Ref Contour (CZC)	Graphic
41	16	0	4	230	ET	Echo Tops (ET)	Raster
42	0	0	4	230	ETC	Echo Tops Contour (ETC)	Graphic
43	16	0	1	230	SWR	Svr Wx Anal - Ref (SWR)	Radial
44	16	0	0.25	230	SWV	Svr Wx Anal - Vel (SWV)	Radial
45	8	0	0.25	230	SWW	Svr Wx Anal - SW (SWW)	Radial
46	16	0	0.5	230	SWS	Svr Wx Anal - Shear (SWS)	Radial
47	0	0	4	230	SWP	Severe Wx Prob (SWP)	Graphic
48	8	0	0	0	VWP	VAD Wind Profile (VWP)	Graphic
49	16	0	0	26	CM	Combined Moment (CM)	Raster
50	16	0	1	230	RCS	Ref X-Sect (RCS)	Raster
51	16	0	0.5	230	VCS	Vel X-Sect (VCS)	Raster
52	8	0	0.5	230	SCS	SW X-Sect (SCS)	Raster

Prod Num	Lvls	Lyr	Resol	Range	Prod ID	Product Name	Format
53	8	0	1	50	WER	Wk Echo Region (WER)	Raster
55	16	0	0.5	230	SRR	Storm Rel Vel Region (SRR)	Radial
56	16	0	1	230	SRM	Storm Rel Velocity (SRM)	Radial
57	16	0	4	230	VIL	Vert Integ Liq (VIL)	Raster
58	0	0	0	345	STI	Storm Track (STI)	Graphic
59	0	0	0	230	HI	Hail Index (HI)	Graphic
60	0	0	0	230	M	Mesocyclone (M)	Graphic
61	0	0	0	230	TVS	Tornadic Vortex Sig (TVS)	Graphic
62	0	0	0	460	SS	Storm Structure (SS)	Text
65	8	1	4	460	LRM	Lyr 1 Comp Ref Max (LRM)	Raster
66	8	2	4	460	LRM	Lyr 2 Comp Ref Max (LRM)	Raster
67	8	2	4	460	APR	Lyr 1 Comp Ref MAX (APR)	Raster
73	0	0	0	0	UAM	User Alert Message (UAM)	Text
74	0	0	0	460	RCM	Radar Coded Message (RCM)	Text
75	0	0	0	0	FTM	Free Text Message (FTM)	Text
77	0	0	0	0	PTM	PUP Text Message (PTM)	Text
78	16	0	2	230	OHP	One Hour Precip (OHP)	Radial
79	16	0	2	230	THP	Three Hour Precip (THP)	Radial
80	16	0	2	230	STP	Storm Total Precip (STP)	Radial
81	256	0	4	230	DPA	Digital Precip Array (DPA)	Raster
82	8	0	40	230	SPD	Supplemental Precip Data (SPD)	Text
83	0	0	0	0	IRM	Intermediate Radar Message (IRM)	Text
84	8	0	0	0	VAD	Vel Az Display (VAD)	Graphic
85	8	0	1	230	RCS	Ref X-Sect (RCS)	Raster
86	8	0	0.5	230	VCS	Vel X-Sect (VCS)	Raster
87	0	0	2	0	CS	Combined Shear (CS)	Raster
88	0	0	2	0	CSC	Combined Shear Contour (CSC)	Graphic
89	8	3	4	460	LRA	Lyr 3 Comp Ref Avg (LRA)	Raster
90	8	3	4	460	LRM	Lyr 3 Comp Ref Max (LRM)	Raster
93	256	0	1.00	115	DBV	ITWS Digital Velocity (DBV)	Radial
94	256	0	1.00	460	DZ	8-bit Refl Array (DZ)	Radial
99	256	0	0.25	230	V	8-bit Velocity Array (V)	Radial
100	0	0	0	0	VSDT	VAD Site Adapt Params (VSDT)	Text
101	0	0	0	0	STIT	Storm Track Alpha block (STIT)	Text
102	0	0	0	0	HIT	Hail Index Alpha block (HIT)	Text
103	0	0	0	0	MT	Mesocyclone Alpha block (MT)	Text
104	0	0	0	0	TVST	TVS Alpha block (TVST)	Text
105	0	0	0	0	CST	Combined Shear Params (CST)	Text
106	0	0	0	0	CSCT	Combined Shr Cntr Parm (CSCT)	Text
107	0	0	0	0	OHPT	1hr Rainfall Params (OHPT)	Text
108	0	0	0	0	THPT	3hr Rainfall Params (THPT)	Text
109	0	0	0	0	STPT	Storm Total Params (STPT)	Text
136	16	0	4	0	CZFMP	Comp Refl Mos Filt Prec(CZFMP)	Raster

Prod Num	Lvls	Lyr	Resol	Range	Prod ID	Product Name	Format
137	16	0	8	0	CZFMP	Comp Refl Mos Filt Prec(CZFMP)	Raster
139	16	0	4	0	CZM	Composite Refl Mosaic (CZM)	Raster
144	16	0	8	0	CZM	Composite Refl Mosaic (CZM)	Raster
153	256	0	0.25	460	HZ	Super-Res Reflectivity (Z)	Radial
154	256	0	0.25	300	HV	Super-Res Velocity (V)	Radial
155	256	0	0.25	300	HSW	Super-Res Spec Width (SW)	Radial
158	16	0	0.25	300	ZDR	Differential Refl (ZDR)	Raster
159	8	0	4	300	ZDR	Differential Refl (ZDR)	Raster
160	16	0	1.0	230	CC	Correlation Coeff (CC)	Radial
161	256	0	0.25	300	CC	Correlation Coeff (CC)	Radial
162	16	0	1.0	230	KDP	Specific Diff Phase (KDP)	Radial
163	256	0	0.25	300	KDP	Specific Diff Phase (KDP)	Radial
164	16	0	1.0	230	HC	Hydrometer Class (HC)	Radial
165	256	0	0.25	300	HC	Hydrometer Class (HC)	Radial
166	0	0	0.0	230	ML	Melting Layer (ML)	Graphic
169	16	0	2.0	230	OHA	One Hour Accum (STA)	Radial
170	256	0	0.25	230	DAA	One Hour Unbiased Accum (DAA)	Radial
171	16	0	2.0	230	STA	Storm Total Accum (STA)	Radial
172	256	0	0.25	230	STA	Storm Total Accum (DSA)	Radial
173	256	0	0.25	230	DUA	User Select Accum (DUA)	Radial
174	256	0	0.25	230	DOD	One Hour Diff (DOD)	Radial
175	256	0	0.25	230	DSD	Storm Total Diff (DSD)	Radial
176	65536	0	0.25	230	DPR	Digital Inst Precip rate (DPR)	Radial
177	256	0	0.25	230	HHC	Hybrid Hydrometer Class (HHC)	Radial
199	16	0	4	0	OHPM	One Hour Precip Mosaic (OHPM)	Raster
200	16	0	8	0	OHPM	One Hour Precip Mosaic (OHPM)	Raster
204	16	0	4	0	ETM	Echo Tops Mosaic (ETM)	Raster
205	16	0	8	0	ETM	Echo Tops Mosaic (ETM)	Raster
208	0	0	0	0	CSAM9	Com Storms Att Mosaic B9 (CSAM9)	Raster
209	0	0	0	0	CSAM	Comb Storms Att Mosaic (CSAM)	Raster
210	16	0	4	0	CPAM	Cum Precip Accum Mosaic (CPAM)	Raster
211	16	0	4	0	ODPM	24-Hr Precip Mosaic (ODPM)	Raster
212	16	0	4	0	CZMP	Comp Refl Mosaic Precip (CZMP)	Raster
213	16	0	8	0	CZMP	Comp Refl Mosaic Precip (CZMP)	Raster
216	16	0	8	0	CPAM	Cum Precip Accum Mosaic (CPAM)	Raster
217	16	0	8	0	ODPM	24-Hr Precip Mosaic (ODPM)	Raster
246	16	0	2	0	ZNM	Refl Mos Non Filt (ZNM)	Raster
247	16	0	2	0	ZNMC	Refl Mos Non Filt Clr (ZNMC)	Raster
249	16	0	2	0	ZM	Base Reflectivity Mosaic (ZM)	Raster
250	16	0	4	0	ZM	Base Reflectivity Mosaic (ZM)	Raster
251	16	0	8	0	ZM	Base Reflectivity Mosaic (ZM)	Raster
253	16	0	4	0	ZMGA	Base Refl Mos Griff+Alb (ZMGA)	Raster
254	8	0	4	0	LRMM	Layer Comp Refl Low Mos (VILM)	Raster



Prod Num	Lvls	Lyr	Resol	Range	Prod ID	Product Name	Format
255	8	0	8	0	LRMM	Layer Comp Refl Med Mos (VILM)	Raster
256	8	0	8	0	LRMM	Layer Comp Refl High Mos (VILM)	Raster
257	16	0	4	0	VILM	Vert Int Liquid Mosaic (VILM)	Raster

**NOTE:** Level III data are radar products generated from the Level II base data. The products are used to assist forecasters and others in weather analysis, predictions, and warnings. Level III products used to be recorded on WORM Optical Disks at NWS sites in the early 1990s. Currently, the required products are provided electronically in near real-time to an NWS Central Collection Facility (CCF). When products were written to the WORM Optical Disks, all products were saved and archived. Now, only required products are collected at the CCF and then archived by National Climatic Data Center (NCDC). Regardless of how the Level III products have been received, the NCDC archives the products in compressed tape archive format on the NCDC Hierarchical Data Storage System (HDSS). The Level III Products archive is available via the World Wide Web on the NCDC Home Page (<http://www.ncdc.noaa.gov/>).

For more information on this subject, go to:

[http://www.roc.noaa.gov/WSR88D/Level\\_III/Level3Info.aspx](http://www.roc.noaa.gov/WSR88D/Level_III/Level3Info.aspx)

## 7.5 RPS list

The RPS list is edited using a Graphical User Interface (GUI) that is part of CAVE. It is accessed via the Radar menu in the D2D perspective.

**NOTE:** When you add products to the RPS list with the AWIPS RPS List Editor, you specify the specific parameters but not the Product Number. If the product is entered in the RPS list with incorrect parameters, it will be interpreted as a different product and not distributed automatically to the WAN. It is very important that the data level, resolution, and elevation be specified correctly in the RPS list or the product will not be distributed properly.

To edit the RPS list:

1. Start CAVE and, if necessary, open the D2D perspective.
2. Select *RPS List Editor...* under the Radar menu. The RPS List Editor will display. (See Exhibit 7.5-1.)

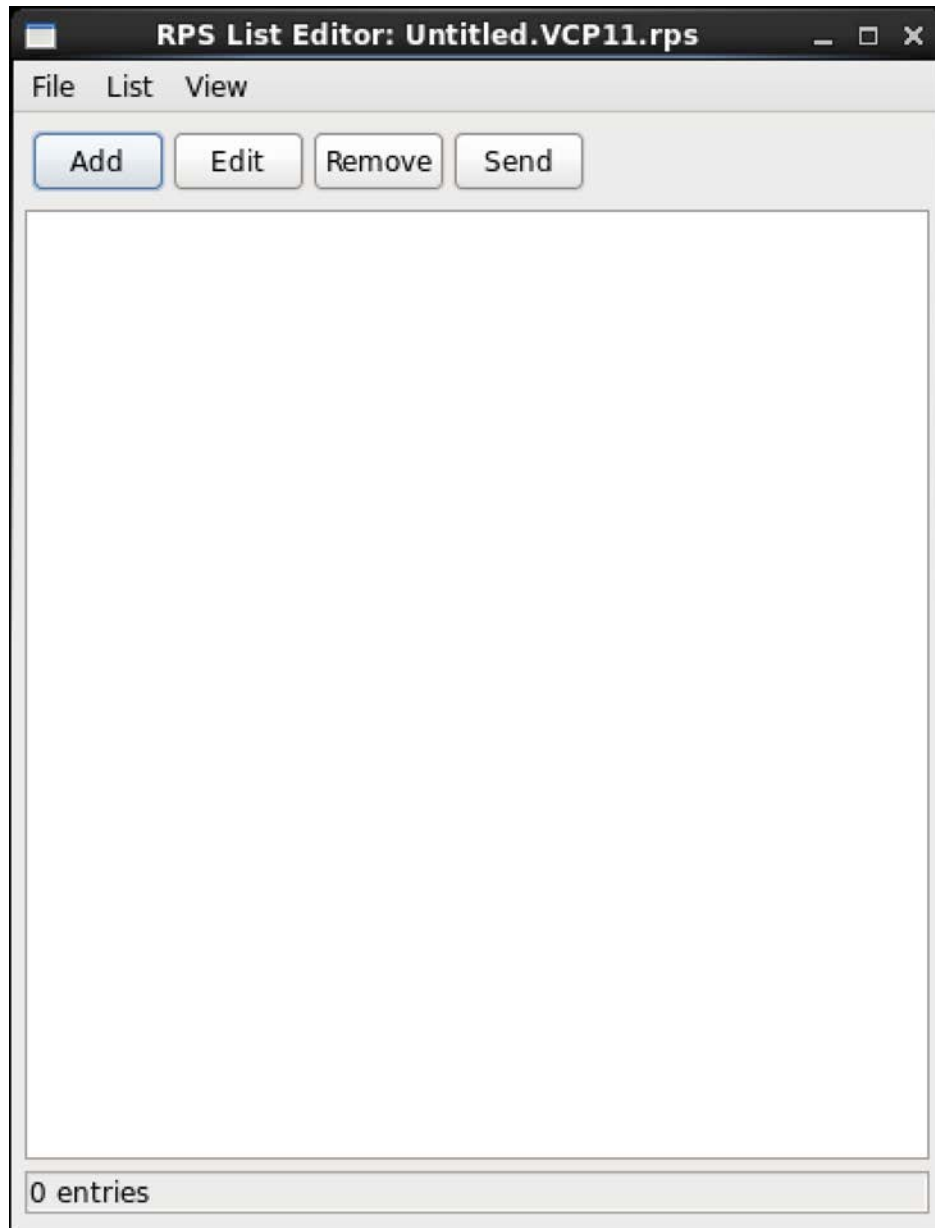

**Exhibit 7.5-1. RPS List Editor**

3. Select the list you want to edit under the View Menu. (See Exhibit 7.5-2.)

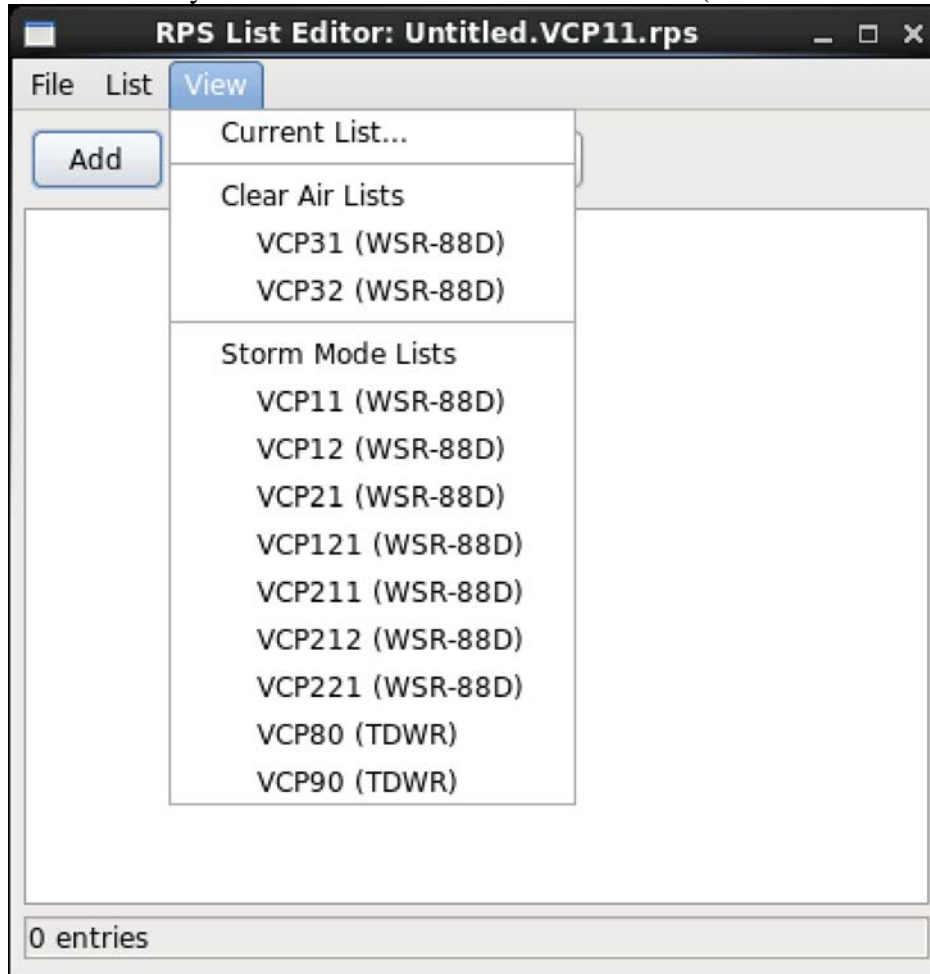

**Exhibit 7.5-2. RPS List Editor View Menu – Select List**

4. After selecting the desired list, it will be displayed in the RPS List Editor. (See Exhibit 7.5-4.)

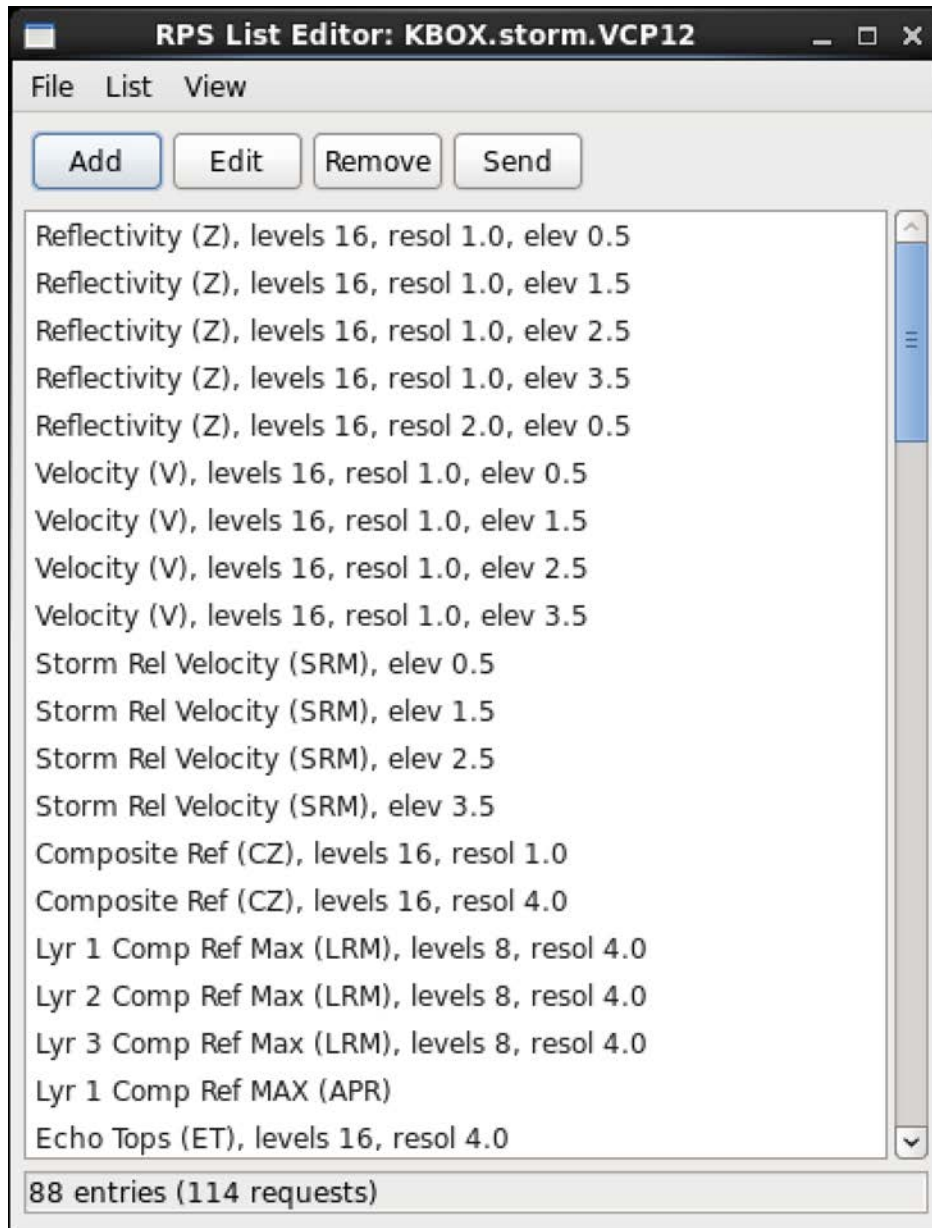

Exhibit 7.5-3. RPS List Editor View Menu List

5. To edit a list entry, select the entry and click *Edit*. Once the entry is displayed in a separate dialog, modify the appropriate values and click *OK*. (See Exhibit 7.5-5.)

The screenshot shows a dialog box titled 'RPS List Editor View Menu List Edit'. It contains the following fields and controls:

- Product:** A text box containing 'Reflectivity (Z)'.
- Priority:** A dropdown menu set to 'Normal'.
- Request interval:** A slider control set to '1'.
- Elevation(s):** Two dropdown menus, the first set to 'Single' and the second set to '0.5'.
- Variant:** A text box containing '16 levels 1.00 res 230.0km'.

At the bottom of the dialog are two buttons: 'OK' and 'Cancel'.

**Exhibit 7.5-4. RPS List Editor View Menu List Edit**

6. To add a new list entry, click *New*. Once the dialog is displayed, select the appropriate entries and click *OK*.
7. To delete a list entry, select the entry and click *Remove*.
8. To submit the list, click *Send*.

## 7.6 Two-Way Communication

As illustrated in Exhibit 7.6-1, the Quartz timer task in EDEX initiates either environmental data or bias table task. The EDEX queries the RadarServer for the list of ORPGs/SPGs (For the environmental data task, EDEX queries the grib data set based on the settings in EnvironParamsLevelTable.xml and generates environmental data message. For the bias table task, EDEX looks for bias table messages that were generated by the hdyro software). The EDEX sends the messages to the RadarServer and the RadarServer sends the messages to the ORPGs/SPGs.

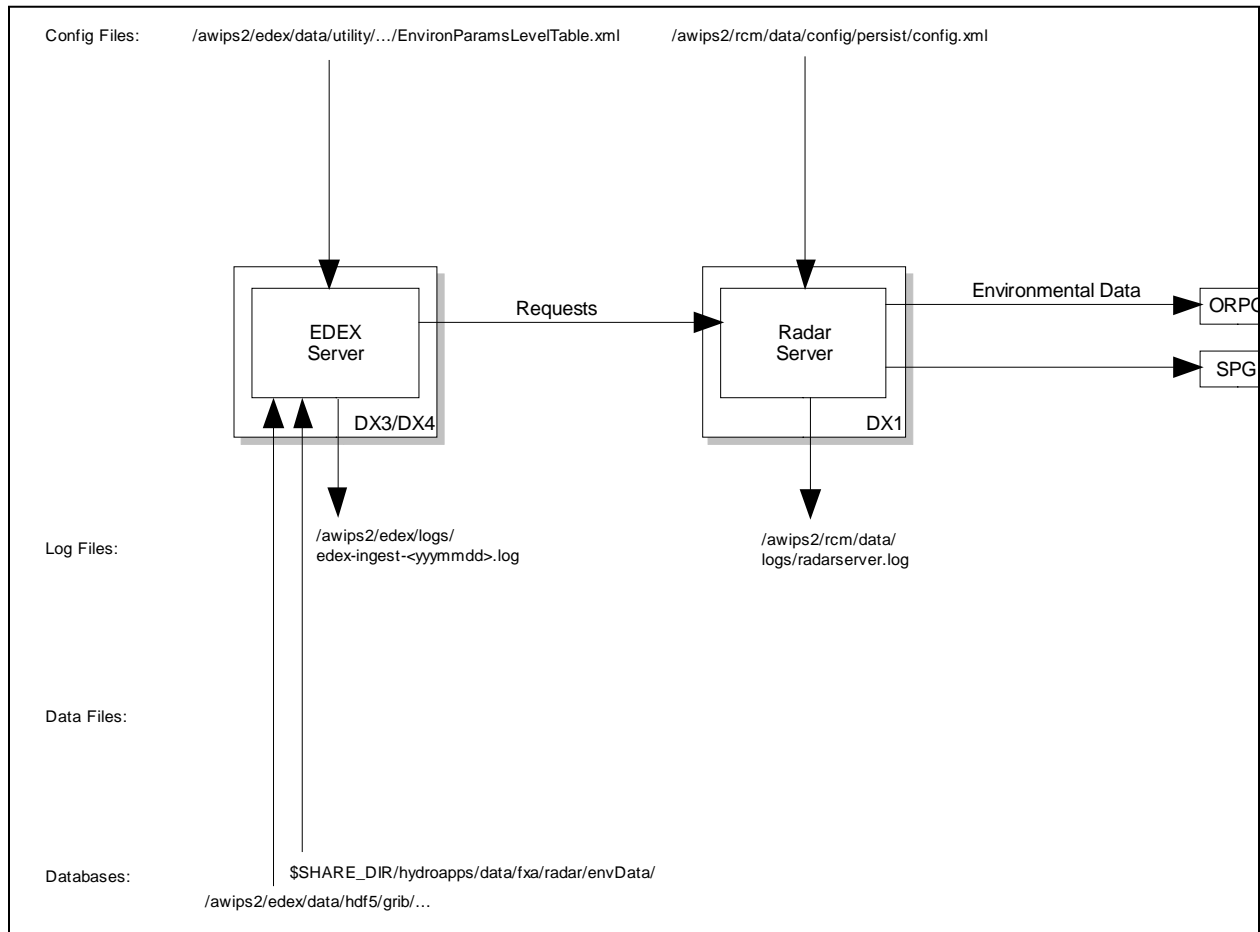

**Exhibit 7.6-1. Sending Environmental Data**

As illustrated in Exhibit 7.6-2:

- **For OTRs:** The CAVE sends requests to the RadarServer which are forwarded to the ORPG and the RadarServer sends OTR status back to CAVE (Not shown).
- **For RMRs:** The CAVE reads and writes the list of available RMRs using the EDEX localization requests. Then the Requests to activate/deactivate RMR requests are sent to the RadarServer. The RadarServer sends the OTR requests to the ORPGs/SPGs according to the contents of the RMR and the RadarServer sends RMR status events back to CAVE while the RMR window is open (not shown).
- **For RPS:** The CAVE queries the RadarServer for the current RPS list. To activate an RPS list, CAVE first sends a request to the RadarServer which then sends an RPS message to the ORPG/SPG.
- **For Alert Requests:** The CAVE queries the RadarServer for the current alert request state and then CAVE sends the updated alert requests to the RadarServer. The RadarServer stores the alert requests in `/awips2/rcm/data/config/persist/` and then sends an alert request message to the ORPG.

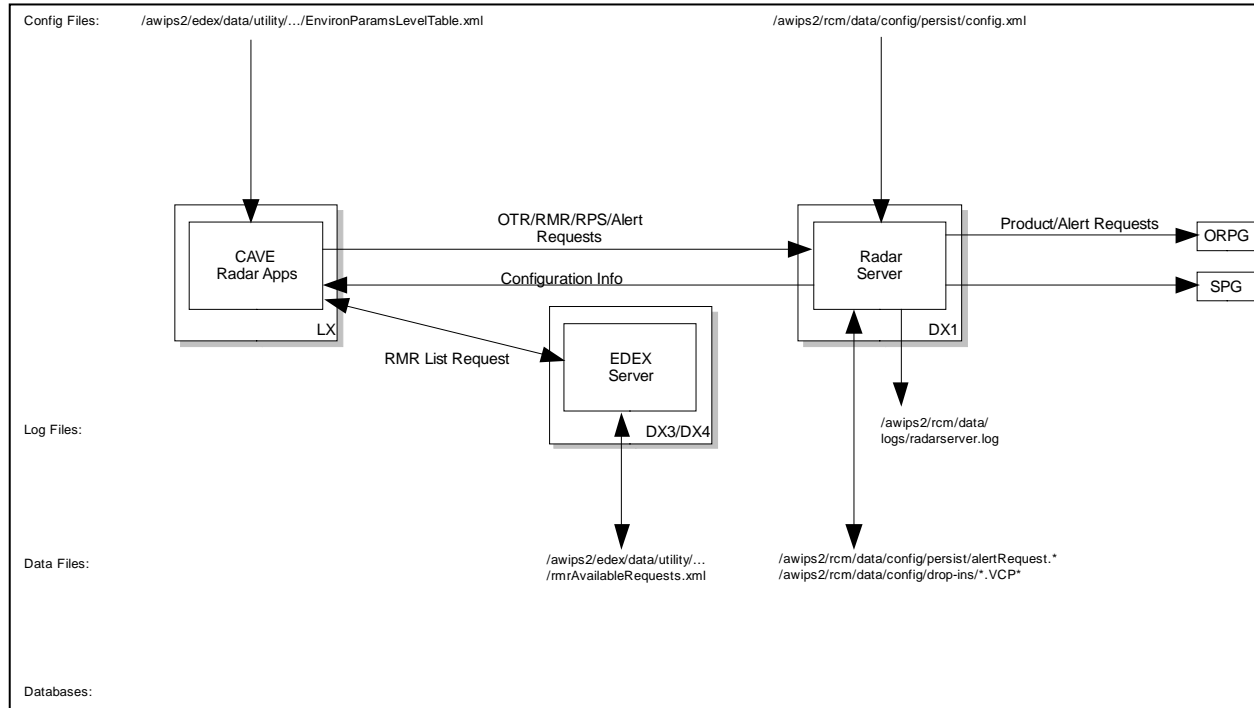

Exhibit 7.6-2. Sending Radar Applications

## 7.7 Central Collection Cron Schedule

The two cron entries for Central Collection Cron Schedule in `cronOTRs.xml` are as follows.

```
<cronOTR cron="0 10 * * * ?" productCode="173" randomWait="300"
hoursBack="3" wmo="SDUS8" nnn="DU3" />
```

```
<cronOTR cron="0 10 12 * * ?" productCode="173" randomWait="300"
hoursBack="24" wmo="SDUS8" nnn="DU6" />.
```

## 7.8 ORPG Backup Operations in AWIPS II

A dedicated connection can be established via the WAN to non-dedicated radar. WAN Dedicated (ORPG Backup) connections work much the same as WAN OTR/RMR. However, with the ORPG backup come's the constant connection with the ability to send an RPS list, rather than just sending one-time or multiple requests that require occasional to frequent user interaction. In AWIPS II, the Radar Server Configuration GUI can be used to both initiate and terminate an ORPG Backup connection. Care must be taken using this GUI as it also has the ability to disconnect a site's own dedicated radar connection, as well.

Establishing this connection in AWIPS I came at the cost of disabling the flow of radar data via the SBN for the radar to which the connection is established. In AWIPS II, the SBN data flow will continue even when the ORPG Backup connection is established

assuming that the primary WFO's connection to the radar is still active and their system is still able to transmit the data. Thus, when generating RPS lists, make sure not to include any products that are already included in the SBN transmission. The exception to this recommendation is if your site is previously configured for and plans to use this backup radar in FSI. Raw radar data is stored differently based on whether it comes from a dedicated connection or the SBN. FSI is configured to only use data obtained via a dedicated connection based on its raw data storage location. Therefore, if your site is pre-configured for and plans to use FSI for this backup radar, then make sure all products you would like to see in FSI are included in the RPS lists.

As in AWIPS I, there is only 1 port available on each RPG for a WAN Dedicated connection and the bandwidth is shared with that of the 4 OTR/RMR ports. Therefore it is important that a connection be made in coordination with other offices that may also need or be interested in the same connection and in consideration of those that may be interested in performing OTR/RMR operations. Also as in AWIPS I, such a connection could have negative impacts on overall bandwidth utilization, thus causing problems sending and receiving all types of products for the primary and the backup WFO. Given these limitations, this connection should only be activated when severe weather is imminent or occurring. Similarly, the connection should be terminated immediately as soon as the event, weather-related or otherwise, that necessitated the connection abates.

The remainder of these instructions assumes that all associated radar files have previously been configured and RPS lists have been generated for ORPG Backup operations. If such a connection has never previously been configured or utilized, please contact the Radar Operations Center (ROC) for a Radar File Help Sheet for your office which will include the instructions to modify the configuration files necessary to make such a connection. If your site was properly configured for ORPG Backup operations in AWIPS I, the configuration would have been migrated over to AWIPS II on your installation day.

There remain two types of ORPG Backup connections, as described below:

**Scenario 1:** Routine Operational Purposes (No WAN Reporting). This is used for:

- Severe weather in or near CWA which is covered well by an adjacent radar
- Backup, either routine or emergency, of another WFO in which the other office is still able to obtain and transmit their own radar data

**Scenario 2:** True Radar Backup Purposes (WAN Reporting). This is used for:

- Backup, either routine or emergency, of another WFO that has some sort of intrusive install or failure in which they are still on the AWIPS WAN, but are not able to either obtain or transmit their own radar data for central collection and distribution via the SBN



## Procedure:

Prior to initiating either scenario of WAN Dedicated radar backup, be sure to coordinate with the WFO that shares access to the radar in question to be sure that the port is free and the office with the higher priority has access to make the connection. Also for both scenarios, the first few steps are the same.

1. In CAVE, go to the D2D Perspective.
2. Click on Radar > Radar Server Configuration..

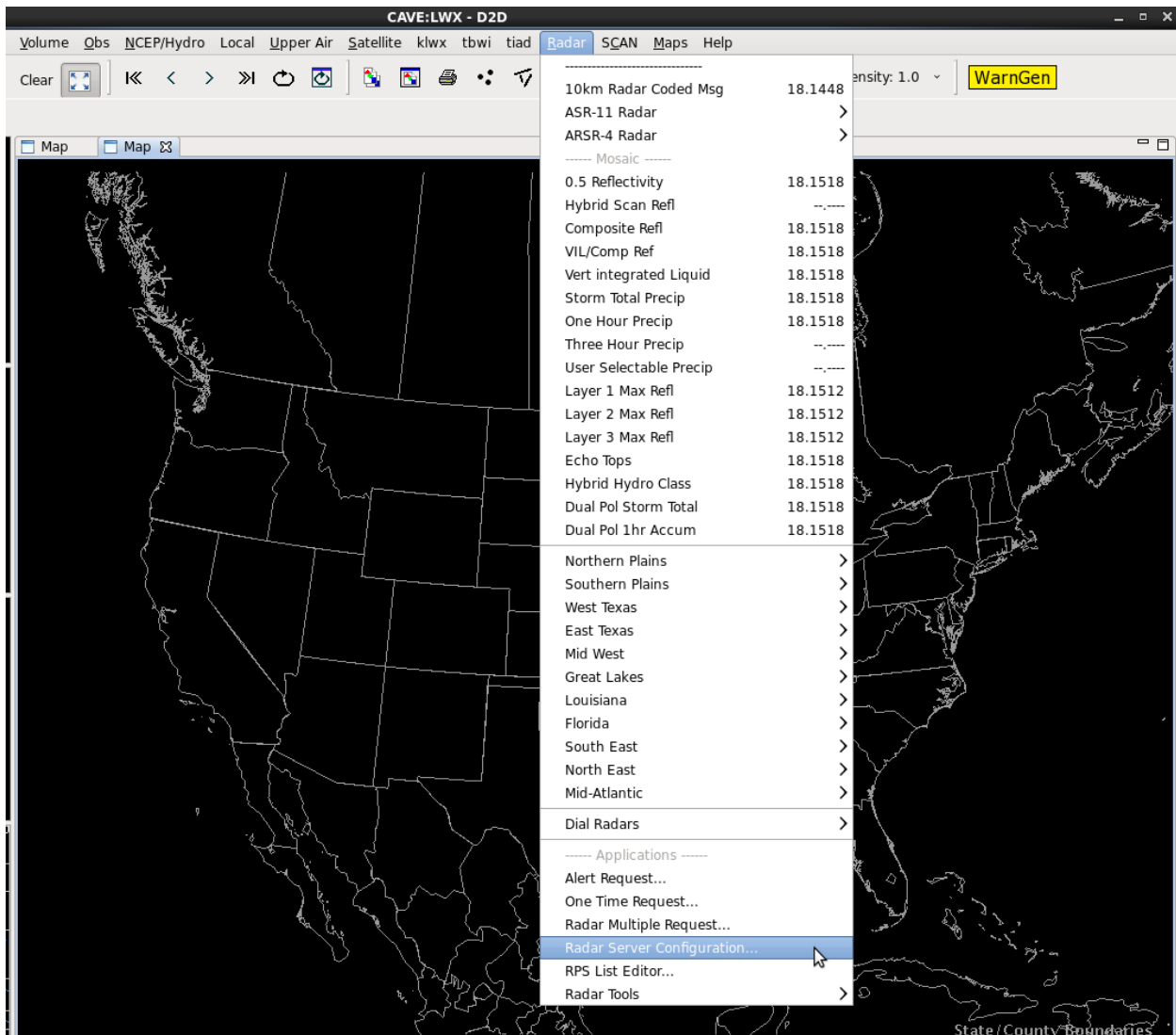

**Exhibit 7.8-1. D2D Perspective in CAVE with the Radar menu selected and Radar Server Configuration highlighted**

3. In the GUI, scroll down under the '-- Dial Radars --' section of the RPGs box on the left-hand side and click on the radar for which you would like to initiate a backup.

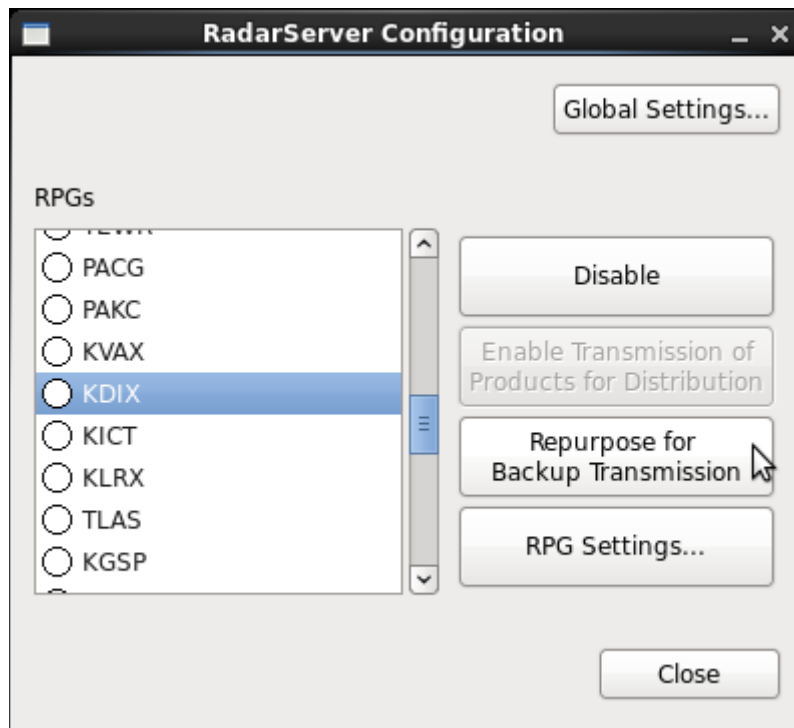
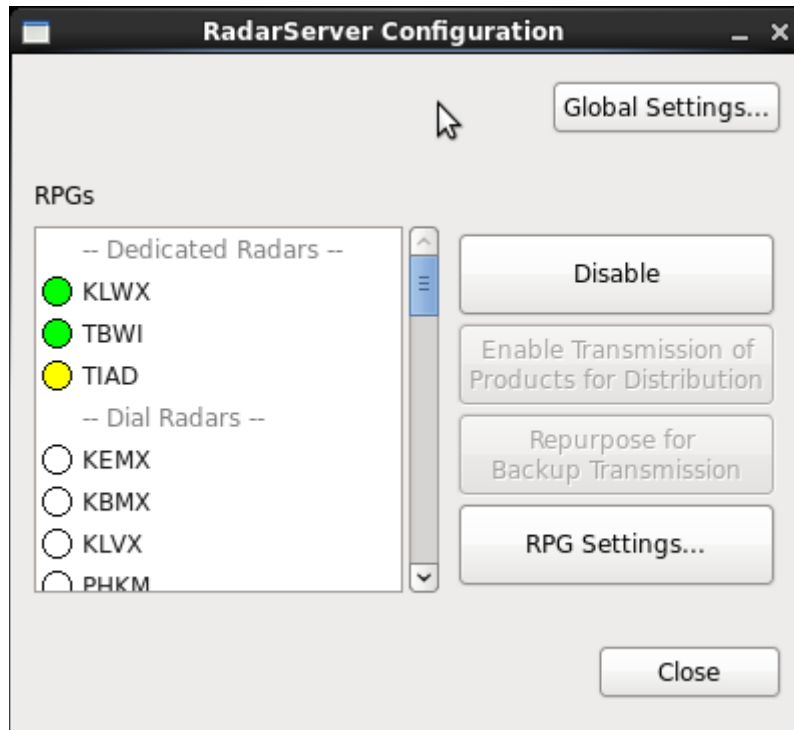

**Exhibit 7.8-2. Select List Select the RPG (Step #3, above) and Repurpose for Backup Transmission (Step #4, below)**

4. With the radar selected, click the 'Repurpose for Backup Transmission' button on the right-hand side to start the connection. At this point the connection is live. The radar

moves up to the ‘-- Dedicated Radars --’ section and the circle next to the radar name is filled green.

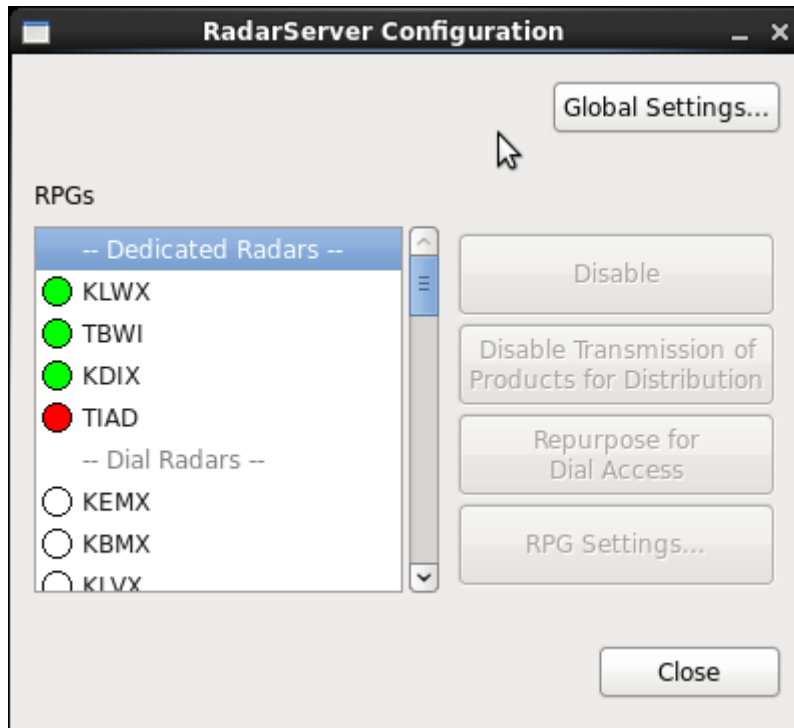

**Exhibit 7.8-3.** The status after Step #4 – KDIX listed under Dedicated Radars with a green circle

**Note:** The default behavior is for the data obtained via this new WAN Dedicated backup to transmit via your site’s MHS to central collection for redistribution on the SBN. This is what one would want if participating in a **Scenario 2: True Radar Backup**. If this is your intention, your connection is now complete and you may proceed with the backup until you are ready to terminate. Otherwise, proceed to Step 5 for **Scenario 1: Routine Operational Backup** to disable the transmission of products.

5. The ‘<Enable|Disable> Transmission of Products for Distribution’ button will display ‘Disable’ when transmission of products is enabled. Select the backup radar under the ‘--Dedicated Radars --’ list then click the ‘Disable Transmission of Products for Distribution’ button to disable the transmission of products and keep all products obtained via this connection in-house only. The button will then change to ‘Enable Transmission of Products for Distribution’.

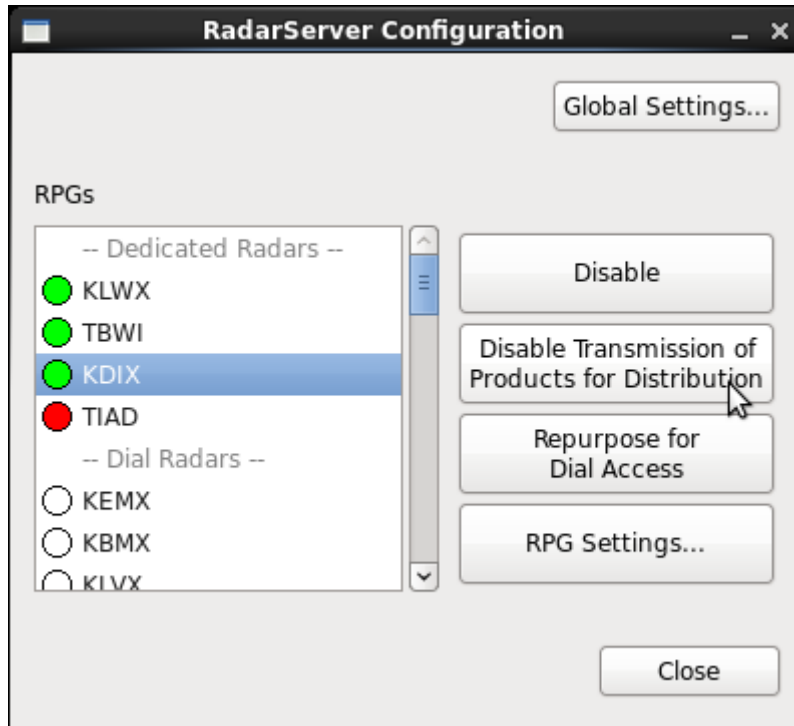
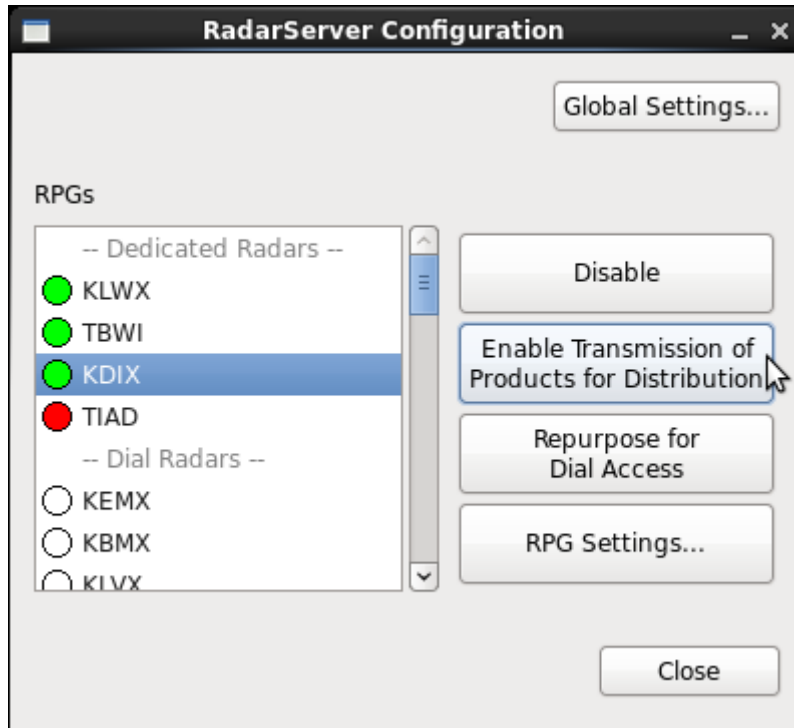

Exhibit 7.8-4. Transmission of Products is enabled.

**Scenario 1** connection is now complete. The GUI should look like this:

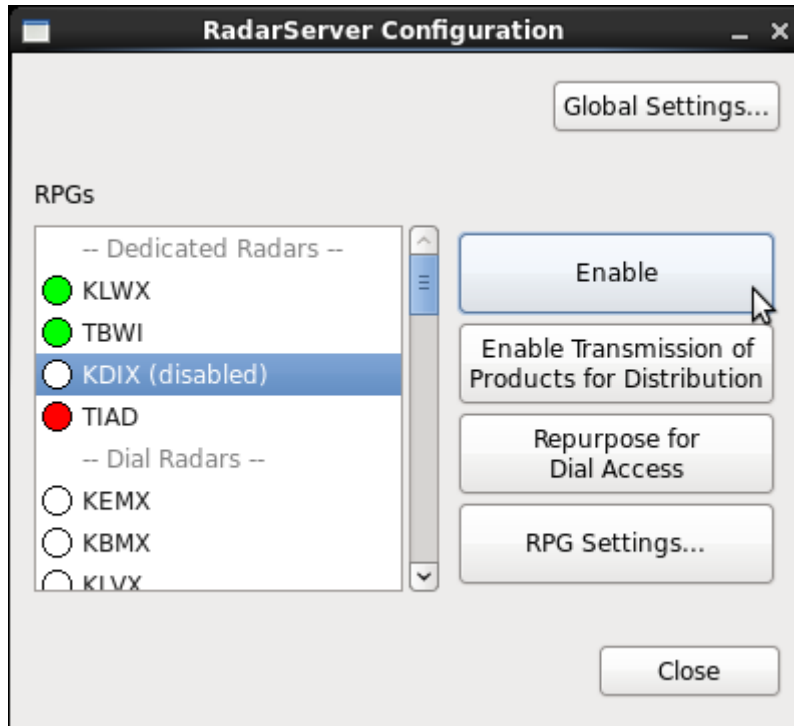

**Exhibit 7.8-5. Transmission of Products disabled.**

Proceed with the backup until you are ready to terminate the connection. Once ready for termination, please follow the steps outlined below.

#### **Terminate WAN Dedicated Backup:**

1. From the Radar Server Configuration GUI, click on the radar name under the '-- Dedicated Radars --' section of the RPGs box on the left-hand side of the GUI.
2. Click 'Disable' on the right-hand side of the GUI. The button itself changes to 'Enable'. The radar remains under the '-- Dedicated Radars --' section, but the circle to the left of the radar name turns white and '(disabled)' appears to the right of the radar name.



**Exhibit 7.8-6. The connection has been disabled, but is still listed as a dedicated radar**

3. Make sure the radar is still selected under the '-- Dedicated radars --' section and then click the 'Repurpose for Dial Access' button on the right-hand side. The radar moves back to the '-- Dial Radars --' section of the RPGs box and continues to display '(disabled)'.

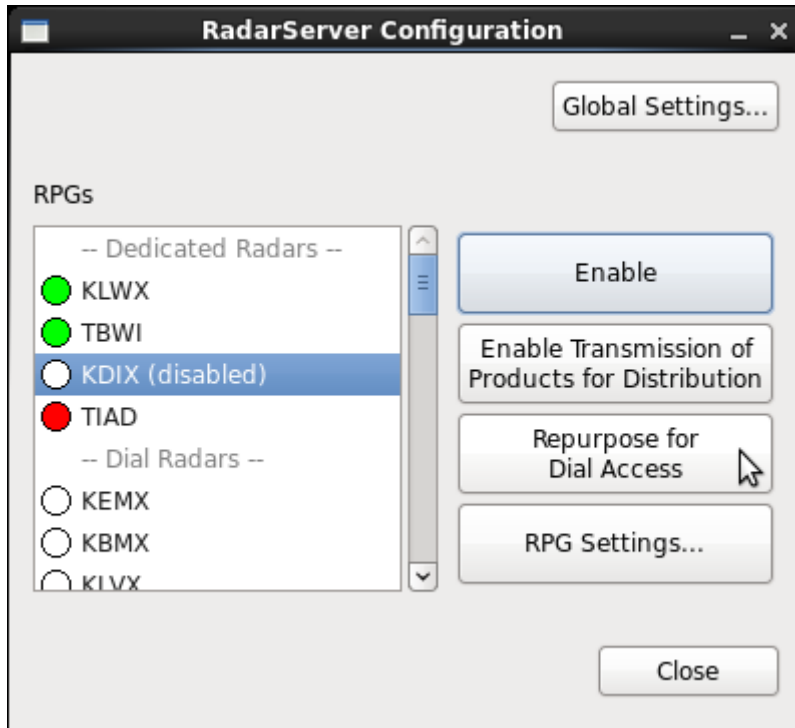

Exhibit 7.8-7. 'Repurpose for Dial Access' button is active

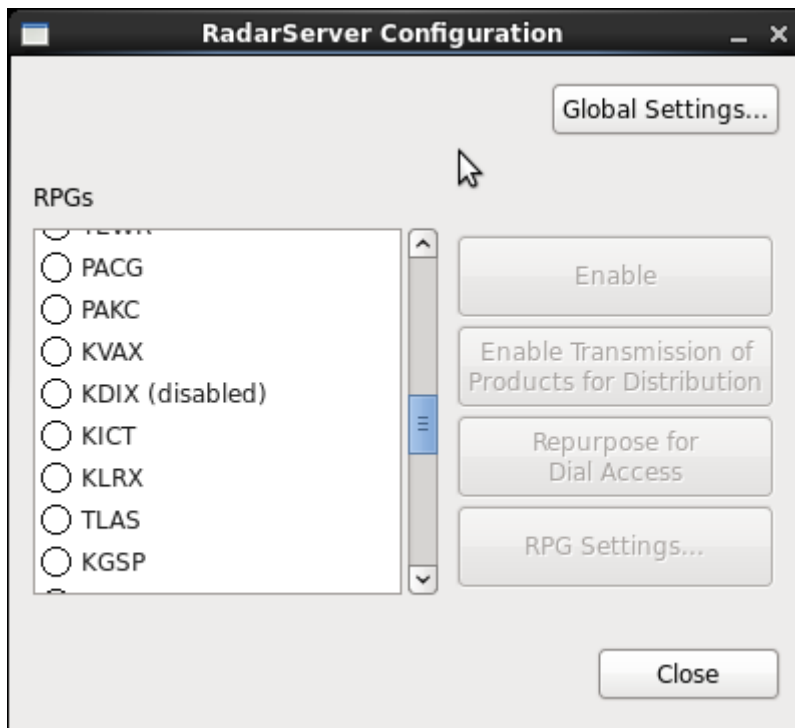
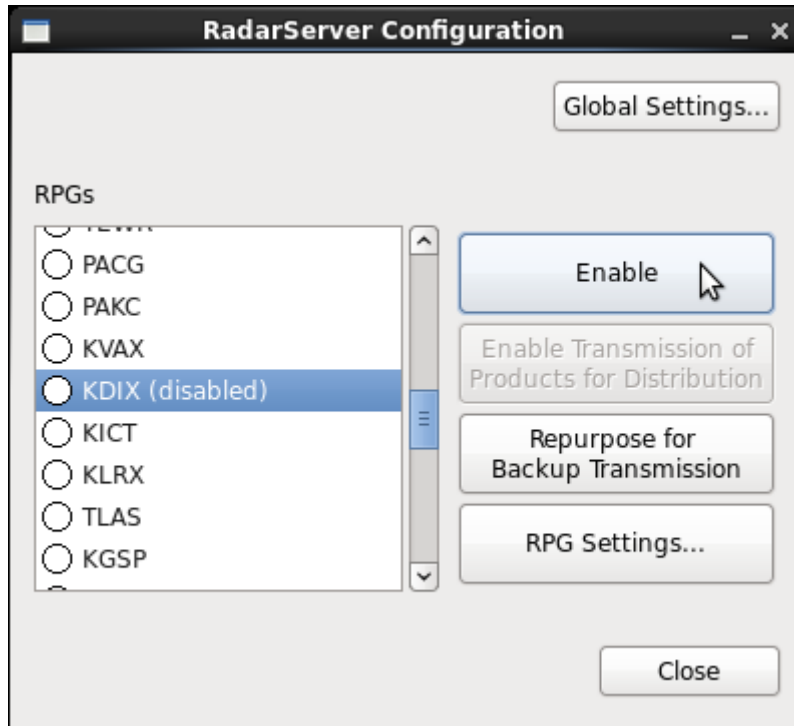

Exhibit 7.8-8. 'Repurpose for Dial Access' button is clicked, the radar moves down to the Dial Radars list, but still says '(disabled)'

- To ensure that OTR and RMR will work for this radar until the next WAN Dedicated backup connection is needed, scroll down to the '-- Dial Radars --' section in the RPGs box and select the radar once again.



**Exhibit 7.8-9. Radar is still disabled and the Enable button is active**

- Click on 'Enable'. The '(disabled)' will then be removed from the right of the radar name. This will allow OTR/RMR to work once again for that radar and will also set it up properly such that the steps provided in this document can be followed as they are written for future WAN Dedicated Backups.



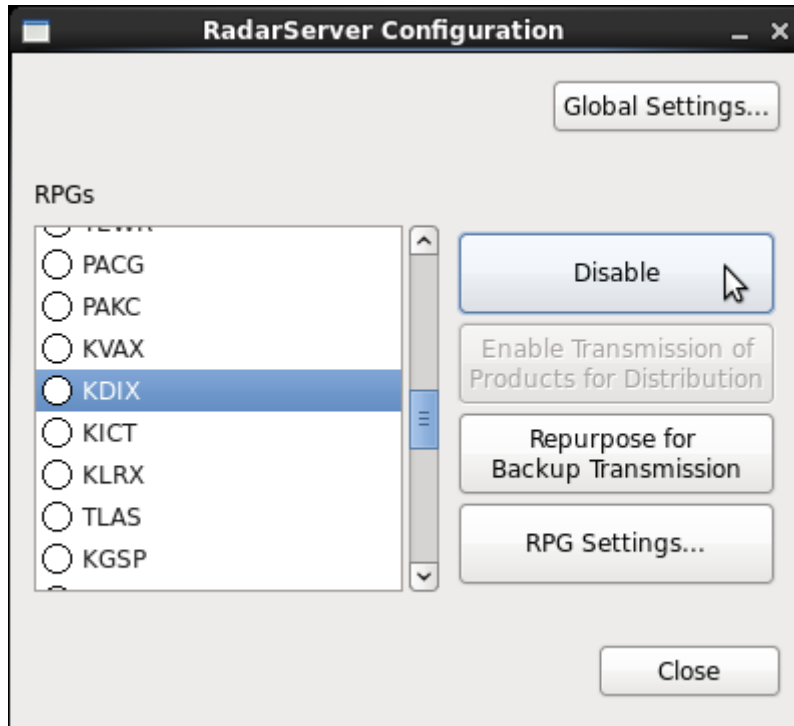

**Exhibit 7.8-10.** The radar is disabled for WAN Dedicated operations, but enabled for OTR/RMR operations

## Log Files:

For office admins that would like to confirm that the backup is functioning, everything is logged to `dx1f:/awips2/rcm/data/logs/radarserver.log`.

- An example of when a connection is made:

```
INFO 16:50:06,171 [ActiveMQ Session Task] RadarServer: Got remote request
SetRadarConfig(kdix)
INFO 16:50:06,188 [ActiveMQ Session Task] RadarServer: Configuration saved
INFO 16:50:06,190 [Thread-45263] RadarServer: kdix: Attempt connection to
165.92.56.75:4493
INFO 16:50:06,208 [Thread-45263] RadarServer: kdix: Connected to
165.92.56.75:4493
INFO 16:50:06,208 [Thread-45263] RadarServer: kdix: Attempt connection to
165.92.56.75:4493
INFO 16:50:06,216 [ActiveMQ Session Task] RadarServer: Got remote request
GetRadarConfig(null)
INFO 16:50:06,225 [Thread-45263] RadarServer: kdix: Connected to
165.92.56.75:4493
INFO 16:50:06,244 [Thread-45263] RadarServer: kdix: connected
INFO 16:50:06,253 [ActiveMQ Session Task] RadarServer: Got remote request
GetRadarStatusMessages(null)
INFO 16:50:10,548 [TCM Read kdix #2] RadarServer: kdix: message code=2
size=200 opMode=storm vcp=21 cuts=[5, 15, 24, 34, 43, 60, 99] rdaOp=online
rdaStat=operate rdaAlarm= dte=refl,vel,sw,dual-pol rpgOp=online
rpgStat=operate rpgAlarm=none avail=avail rdaVer=14.0 rpgVer=14.1
```

- Then the RPS List is sent:

```
INFO 16:50:10,694 [TCM Read kdix #2] RadarServer: kdix: Sending RPS list with
65 entries (65 requests)
```

- Then you should see the flow of data begin:

```
INFO 16:51:15,357 [TCM Read kdix #2] RadarServer: kdix: message code=94
size=5520 elev=2.5 sequence=2147 vs=2014-12-11 17:03:51 #67
```

- If you are sending the data to the WAN, you will then see a call to msg\_send:

```
INFO 16:51:15,357 [TCM Read kdix #2] RadarServer: Sending kdix code=94
header=SDUS24 KLWX 111703 / N2QDIX (matched prodList)
INFO 16:51:15,357 [Thread-13] RadarServer: Running [/awips/ops/bin/msg_send,
-c, 0, -p, 1, -e, /tmp/rcm5212925225564643269.tmp, -a, DEFAULTNCF
```

- Then the message is stored (if data is not being sent, then you will see the first message above followed immediately by the message below, skipping the prodList and msg\_send messages):

```
INFO 16:51:15,363 [TCM Read kdix #2] RadarServer: Stored message in
/data_store/radar/kdix/Z/elev2_4/res1/level256/kdix.94.20141211_1703
```

- A successful disconnect will look like the following:

```
INFO 16:53:46,653 [ActiveMQ Session Task] RadarServer: Got remote request
SetRadarConfig(kdix)
INFO 16:53:46,660 [ActiveMQ Session Task] RadarServer: Configuration saved
INFO 16:53:46,662 [ActiveMQ Session Task] RadarServer: kdix: disconnected
INFO 16:53:49,213 [ActiveMQ Session Task] RadarServer: Got remote request
SetRadarConfig(kdix)
INFO 16:53:49,221 [ActiveMQ Session Task] RadarServer: Configuration saved
INFO 16:53:49,228 [ActiveMQ Session Task] RadarServer: Got remote request
GetRadarConfig(null)
INFO 16:53:49,254 [ActiveMQ Session Task] RadarServer: Got remote request
GetRadarStatusMessages(null)
INFO 16:53:55,765 [ActiveMQ Session Task] RadarServer: Got remote request
SetRadarConfig(kdix)
INFO 16:53:55,773 [ActiveMQ Session Task] RadarServer: Configuration saved
```

- All of the message above are related to the steps taken to not only disable the radar, but then to repurpose for dial backup and then enable for OTR/RMR. Each time a change is made to the configuration, the dx1f:/awips2/rcm/data/config/persist/config.xml is changed accordingly.

**Chapter 8**  
**Local Data Acquisition and**  
**Dissemination (LDAD) System**

## Chapter 8. Local Data Acquisition and Dissemination (LDAD) System

### Table of Contents

	<i>Page</i>
8.1 LDAD Functionality .....	1
8.2 LDAD Hardware Configuration .....	2
8.2.1 LAN Hub.....	2
8.2.2 LDAD Terminal Server .....	2
8.2.3 Modem Nest.....	4
8.2.4 LDAD Firewall .....	4
8.2.5 LDAD Server .....	5
8.3 LDAD Software Configuration.....	5
8.3.1 LDAD Gateway .....	7
8.3.2 Scheduler.....	10
8.3.3 Communications Server.....	11
8.3.4 Inter-Gateway Communication.....	11
8.3.5 Local Data Management .....	11
8.3.6 Preprocessors .....	12
8.3.7 Decoder and Storage .....	13
8.4 Rsync.....	13
8.4.1 Rsync with AWIPS (internal) and External (non-AWIPS) Systems .....	13
8.4.2 Rsync Configuration Files .....	14
8.5 LDAD Linux Server Heartbeat Cron Package.....	14
8.6 Quality Control and System Monitoring.....	16
8.6.1 Quality Control .....	16
8.6.2 System Monitoring.....	18
8.7 Acquire LARC/Handar 555 Data.....	19
8.7.1 User Interface: ldadScheduler .....	23
8.7.2 ldadServer .....	23
8.7.3 tell_co.....	26
8.7.4 listener.....	26
8.7.5 CO_serv .....	28
8.8 Decode LARC/Handar 555 Data .....	29
8.8.1 newLDADdataNotification.....	30
8.8.2 CO_serv .....	33
8.8.3 listener.....	34

8.8.4	preProcessLDAD.pl .....	35
8.8.5	preprocessLARC.pl.....	36
8.8.6	LDAD_ROUTER.....	36
8.8.7	DataController.....	37
8.8.8	routerLdadDecoder .....	39
8.8.9	routerStoreTextEDEX.....	40
8.8.10	routerStoreEDEX.....	41
8.8.11	routerShefEncoderEDEX.....	42
8.8.12	distributeProduct.....	43
8.9	Acquire Campbell Data.....	44
8.9.1	User Interface: ldadScheduler .....	49
8.9.2	ldadServer .....	49
8.9.3	tell_co.....	51
8.9.4	listener.....	52
8.9.5	CO_serv .....	53
8.9.6	process_expect .....	54
8.9.7	callSite.ksh.....	55
8.9.8	campbell decoder .....	55
8.10	Decode Campbell Data .....	56
8.10.1	newLDADdataNotification .....	57
8.10.2	CO_serv .....	60
8.10.3	listener.....	61
8.10.4	preprocessCAMPBELL.pl .....	63
8.10.5	LDAD_ROUTER.....	64
8.10.6	DataController.....	65
8.10.7	routerLdadDecoder.....	66
8.10.8	routerStoreEDEX .....	68
8.10.9	routerShefEncoderEDEX.....	69
8.10.10	distributeProduct.....	70
8.10.11	notificationServer.....	71
8.11	Acquire Sutron Data .....	72
8.11.1	User Interface: ldadScheduler .....	78
8.11.2	ldadServer .....	78
8.11.3	tell_co.....	79
8.11.4	listener.....	80
8.11.5	CO_serv .....	81
8.11.6	process_expect .....	83

8.11.7	callSite.ksh .....	83
8.11.8	sutron decoder .....	84
8.12	Decode Sutron Data .....	84
8.12.1	newLDADdataNotification .....	85
8.12.1	CO_serv .....	88
8.12.2	listener .....	89
8.12.3	preprocessSUTRON.pl.....	90
8.12.4	LDAD_ROUTER.....	91
8.12.5	DataController.....	92
8.12.6	routerLdadDecoder.....	93
8.12.7	routerStoreEDEX .....	94
8.12.8	routerShefEncoderEDEX.....	95
8.12.9	distributeProduct .....	96
8.12.10	notificationServer.....	98
8.13	Acquire and Decode Comma Separated Variable Mesonet Data .....	100
8.13.1	CO_serv .....	103
8.13.2	newLDADdataNotification .....	104
8.13.3	listener .....	105
8.13.4	preProcessLDAD.pl .....	106
8.13.5	preprocessmesonet.pl .....	107
8.13.6	LDAD_ROUTER.....	107
8.13.7	DataController.....	108
8.13.8	routerLdadDecoder.....	110
8.13.9	routerStoreEDEX .....	111
8.14	Acquire and Process ASOS/MicroART Data (for LDAD).....	113
8.14.1	suaReceiver .....	116
8.14.2	newLDADdataNotification .....	117
8.14.3	CO_serv .....	118
8.14.4	listener .....	119
8.14.5	preprocessSUA.pl.....	120
8.14.6	Reserved.....	121
8.14.7	distributeProduct .....	121
8.15	Using LDAD Scheduler .....	122
8.15.1	Using LDAD Scheduler to Modify Gauges with Session Files .....	122
8.15.2	Using LDAD Scheduler to Add Users .....	129
8.16	Alaska Profiler Data.....	133
8.16.1	newLDADdataNotification .....	134

8.16.2	CO_serv .....	136
8.16.3	listener .....	137
8.16.4	LDAD_ROUTER.....	138
8.16.5	DataController.....	139
8.16.6	routerStoreAkBlpEDEX .....	141
8.16.7	notificationServer .....	142
8.17	Acquire and Process Radiosonde Replacement System (RRS) Data (for LDAD) .....	143
8.17.1	newLDADdataNotification .....	143
8.17.2	CO_serv .....	146
8.17.3	listener .....	147
8.17.4	preprocessRRS.pl.....	148
8.17.5	Reserved.....	150
8.17.6	distributeProduct .....	150
8.18	LDM Setup and Data Ingest Configuration .....	151
8.18.1	LDM Setup.....	151
8.18.2	LDM Data Ingest Configuration .....	152
8.18.3	LDM Processes and Configuration Files .....	153
8.18.4	LDM Product-Queue.....	154
8.18.5	Useful LDM Commands .....	155
8.19	LDAD and PX2.....	156
8.19.1	LDADinfo.txt.....	157
8.19.2	PX2 Log Files .....	157
8.20	LDAD Troubleshooting.....	159
8.20.1	LDAD Disk Removal.....	159
8.20.2	LDAD Server Disk Mirroring Procedure.....	159
8.20.3	Fax Modem Troubleshooting.....	161

### **List of Exhibits**

Exhibit 8.2-1.	LDAD Hardware Configuration .....	3
Exhibit 8.3-1.	Flow of LDAD Data to EDEX.....	6
Exhibit 8.3.1-1.	Generic Acquire and Decode LDAD Product (Page 1 of 2).....	8
Exhibit 8.3.1-1.	Generic Acquire and Decode LDAD Product (Page 2 of 2).....	9
Exhibit 8.3.5-1.	LDM Ingest.....	12
Exhibit 8.7-1.	Acquire LARC/Handar 555 Data (for LDAD) .....	24
Exhibit 8.8-1.	Decode LARC/Handar 555 Data (for LDAD) (Page 1 of 2) .....	31
Exhibit 8.8-1.	Decode LARC/Handar 555 Data (for LDAD) (Page 2 of 2) .....	32

Exhibit 8.9-1. Acquire Campbell Data (for LDAD) ..... 50

Exhibit 8.10-1. Decode Campbell Data (for LDAD) (Page 1 of 2) ..... 58

Exhibit 8.10-1. Decode Campbell Data (for LDAD) (Page 2 of 2) ..... 59

Exhibit 8.11-1. Acquire Sutron Data (for LDAD) ..... 77

Exhibit 8.12-1. Decode Sutron Data (for LDAD) (Page 1 of 2) ..... 86

Exhibit 8.12-1. Decode Sutron Data (for LDAD) (Page 2 of 2) ..... 87

Exhibit 8.13-1. Acquire and Decode Comma Separated Variable Mesonet Data (for LDAD)  
(Page 1 of 2) ..... 101

Exhibit 8.13-1. Acquire and Decode Comma Separated Variable Mesonet Data (for LDAD)  
(Page 2 of 2) ..... 102

Exhibit 8.14-1. Acquire and Process ASOS/MicroART Data (for LDAD) (Page 1 of 2) ..... 114

Exhibit 8.14-1. Acquire and Process ASOS/MicroART Data (for LDAD) (Page 2 of 2) ..... 115

Exhibit 8.15.1-1. The Modify Gauges Dialog Box ..... 123

Exhibit 8.15.1-2. Campbell-Specific Information ..... 124

Exhibit 8.15.1-3. Sutron-Specific Information ..... 124

Exhibit 8.15.1-4. The Edit Storage Area Reporting Format Dialog Box ..... 125

Exhibit 8.15.1-5. The Choose Session File Dialog Box ..... 126

Exhibit 8.15.1-6. The Edit Session Dialog Box with the Contents of a Session File ..... 127

Exhibit 8.15.1-7. The Copy File Contents Dialog Box ..... 128

Exhibit 8.15.2-1. The Modify Users Dialog Box ..... 129

Exhibit 8.15.2-2. The New User Dialog Box ..... 130

Exhibit 8.15.2-3. The Status Dialog Box ..... 132

Exhibit 8.16-1. Decode Alaska Profiler Data ..... 135

Exhibit 8.17-1. Acquire and Process RRS Data (for LDAD) (Page 1 of 2) ..... 144

Exhibit 8.17-1. Acquire and Process RRS Data (for LDAD) (Page 2 of 2) ..... 145

### **List of Tables**

Table 8.2.2-1. Port Assignments ..... 4

Table 8.3.1-1. LDAD Environment Variables on LDAD Cluster (LS) and/or PX1, PX2 ..... 7



The Local Data Acquisition and Dissemination (LDAD) system provides the means to acquire local data sets, perform quality control on the incoming data, and disseminate weather data to the external user community. It contains a number of components that reside on the internal AWIPS network (on the PX) and on the external LDAD component (on the LDAD server [LS] cluster). The internal and external components are separated by a security firewall. [Refer to **Appendix L** for additional information.]

The LDAD system was developed with three things in mind: the inherent site-to-site variability; site-specific information changes with time; and the need to merge older technology with current capabilities that continue to change. Thus LDAD was built using modular and generalized software component architecture. For example, all modem commands are entered as part of session files or scripts that a program reads and uses to send the appropriate commands to the modem.

The processing of the data acquisition system is shared between the local data provider and the NWS. ALERT data were previously acquired by a dedicated connection between the ALERT base-station and a computer that accepted the various weather data in the form of gauge tips for rain, voltage for temperature and pressure, etc. These values had to be converted from electronic values to meteorological values using calibrated conversions. Every time sensors were recalibrated, added, or removed by the provider, the support team had to revise and edit the appropriate sensor table. Because each provider had its own specific format, a decoder and storage module had to be developed for each data type to be acquired.

The basic LDAD concept simplifies this process for both the data providers and for the support team. LDAD uses a simple data format, ASCII Comma Separated Values Text (CSVText), which separates each data field by a comma. A set of metadata files, created and maintained by the data provider or in conjunction with site personnel, will be used by the acquisition decoder. This facilitates data processing in hydrometeorological units instead of sensor units and removes the need for conversion routines. The simplicity of the CSVText format increases the likelihood that the data provider will use this standardized format.

All LDAD acquisition data are categorized and stored into the following four classes:

- Mesonet for surface weather observations
- Hydro for rain and stream observations
- Manual for manual observations such as cooperative observers
- Upper air for multilevel observations such as profilers.

## **8.1 LDAD Functionality**

The LDAD functionality supports the acquisition of the Integrated Flood Observing and Warning System (IFLOWS); ALERT; Mesonet; Profiler; RRS/Upper Air; Gauges (LARC, Handar, Campbell, Sutron); COOP (Co-operative Observations); and other data transported via LDM, Rsync, or other TCP/IP Protocols. The Data Acquisition function is

achieved when data is transmitted to the internal (trusted) AWIPS servers (i.e., PX cluster). The data is transmitted to and from the LDAD Cluster via TCP/IP protocols or RS-232 communications. The Data Dissemination function is achieved when data is transmitted to the LDAD Cluster from the internal AWIPS system and is then distributed to External Users. The data can be acquired, stored, and displayed once fully configured.

## **8.2 *LDAD Hardware Configuration***

The LDAD hardware configuration depicted in Exhibit 8.2-1 details the interconnection of the various components that comprise the LDAD system. The LDAD System consists of two LDAD servers (LS2/3), a LAN switch (SMC 8024), a Terminal Server (Cyclades ACS32), Modems (MultiTech MT5600BR), and a LAN DMZ (HP ProCurve 2824). The DMZ consists of two SSG 320M Firewalls, a Netgear 16 switch, and two Netgear 5 port hubs. The LDAD baseline processes run on the LDAD Cluster (DMZ) and the AWIPS PX Cluster (Internal). Other local applications may run on other internal clusters, such as DX cluster in the case of the LDAD Dissemination Server. Data is transmitted through the DMZ either to the Trusted (internal) AWIPS system or to the Untrusted (External) Users/Systems.

### **8.2.1 *LAN Hub***

The LDAD LAN Switch in Exhibit 8.2-1 is an SMC Networks 8024 switch with 24 1000 BaseT ports. The LAN Switch provides connectivity to external users/systems, the LDAD Terminal Server (Management/Modem RS-232), and the Untrusted side of the LDAD Firewalls (FW1/2).

### **8.2.2 *LDAD Terminal Server***

The LDAD Terminal Server is a Cyclades Alterpath ACS32, which provides an Ethernet interface for connection to the LDAD LAN Switch and 32 serial ports for connections to communication devices such as the modems in the Modem Nest, and Console Management ports such as the LS2/3 Servers. Each port can be configured to a maximum speed of 56 K. The terminal server in an average configuration is used to connect 10 dial-in/dial-out modems (including MicroART, RRS, and ASOS), four dedicated modems, a fax modem, and various console connections.

Port assignments are shown in Table 8.2.2-1 as an example.

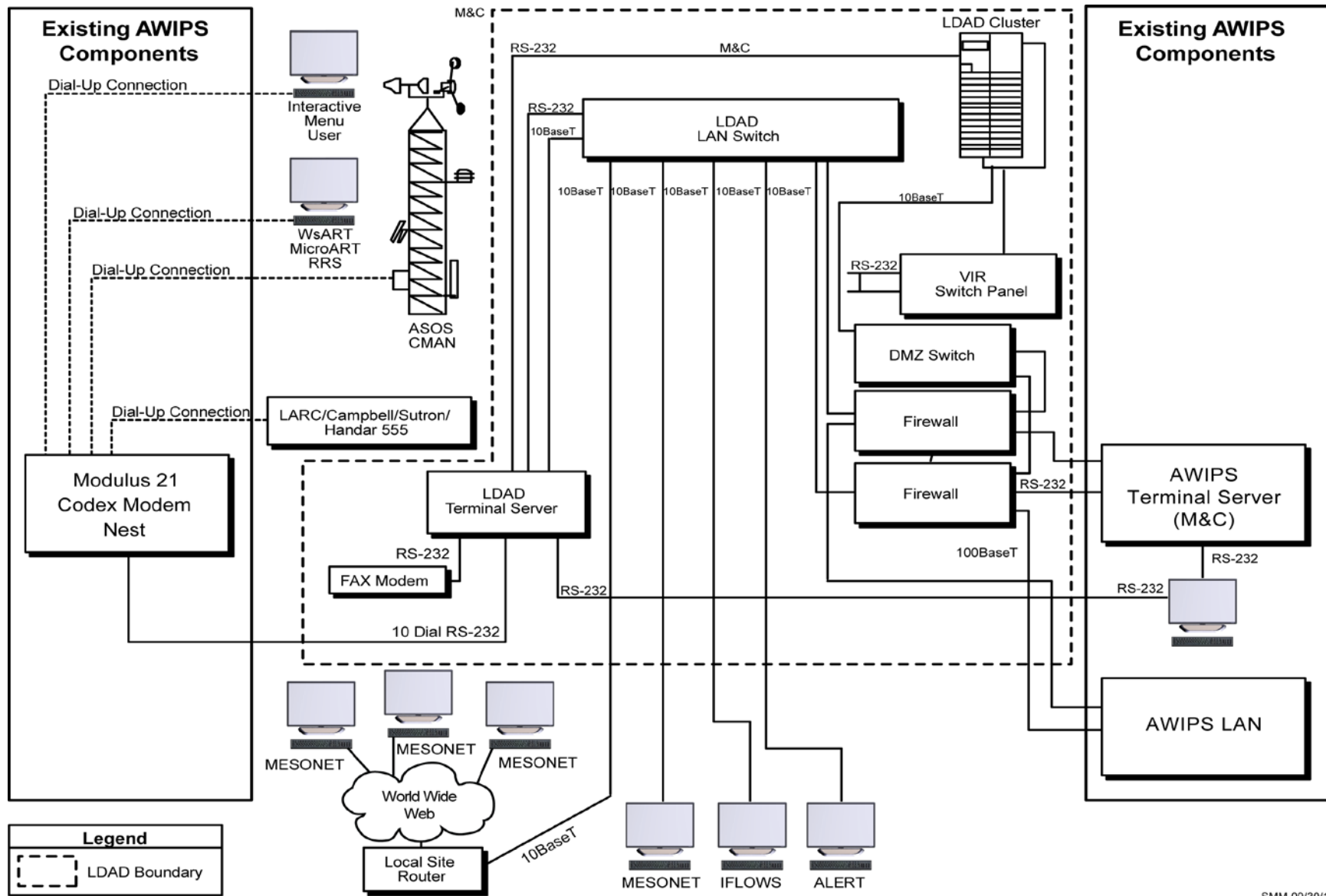

Exhibit 8.2-1. LDAD Hardware Configuration

**Table 8.2.2-1. Port Assignments**

Port	Function
1	Used to dial-out to devices configured for 7 bits, even parity
2	Used to dial-out to devices configured for 8 bits, no parity
3	First dial-in line, 8 bits, no parity
4	Second dial-in line, 8 bits, no parity
5	Third dial-in line, 8 bits, no parity
6	Fourth dial-in line, 8 bits, no parity
7	Fifth dial-in line, 8 bits, no parity
8	Sixth dial-in line, 8 bits, no parity
9	MicroART Modem
10	ASOS Modem
21	First Dedicated Modem
22	Second Dedicated Modem
23	Third Dedicated Modem
24	Fourth Dedicated Modem
30	Fax Modem

The LDAD Server system is configured with a block of IP Addresses assigned by the site. These Class C IP addresses were assigned to the site (non-AWIPS IP addresses) by the NWS, and generally a block of 15 IP addresses should be set aside specifically for LDAD usage. IP Addresses are required for the Terminal Server, software services (i.e., Radius) running on the Terminal Server, certain ports on the Terminal Server (dependent upon function), the LDAD Firewalls, and the NAT (Network Address Translation) Table stored on the firewalls. An additional IP address may be needed for the Web Server running on the LS.

### 8.2.3 *Modem Nest*

The LDAD modems are located in the MultiTech chassis. There are a total of 16 available slots for MultiTech modem cards (MT5600BR) and 2 power supplies (PS1600). All sites have a minimum of 10 modems for dial-out, dial-in, and fax capability.

### 8.2.4 *LDAD Firewall*

Two SSG 320M firewalls are employed to provide network security for the LDAD and AWIPS systems. Each AWIPS site will have two firewalls controlled by central configuration management servers. The central configuration management servers are located at the NCF and the BNCF. The control over the firewall configurations is tiered with the central configuration management server having ultimate control. The regions have a client Security manager that connects to the NCF Central Server, which in turn connects back to the firewall. Individual AWIPS sites (forecast offices) will not have direct control over their own configurations.

### 8.2.5 *LDAD Server*

The LS cluster is a pair of HP ProLiant DL320 Linux servers. The LS machines provide the focal point for all external communications between the AWIPS site and the community, functioning as a pass-through device for all incoming and outgoing data. Only one server is actively running the heartbeat package at a given time, and it will be the one reachable through the address 192.168.1.10 (“ls1”) via the LDAD LAN switch. In this document, “the active LS” refers to whichever machine is actively working as the LDAD server, listening on the address 192.168.1.10, and reachable through the AWIPS LAN via the hostname “ls1.” This hostname will reach the active LS from the entire AWIPS site LAN, no matter which of the LS machines is presently serving as the active LS.

The ls2/ls3 servers have unique interfaces (ls2-192.168.1.11, ls3-192.168.1.12) that are up at all times. The ls2/3 heartbeat is a private lan pair (ls2-172.16.0.2, ls3-172.16.0.1). The ls2/ls3 servers share an external IP address for access to the site local LAN and the Internet for data push/pull collection. This external ldad address is assigned by the site and configured by the region in the site's LDAD firewall. It is routed by the firewall using Mapped IP (MIP) to the active LS; there is no external network interface connection on the LDAD server.

The VIR switch provides the capability to switch asynchronous serial connections between LS2 and LS3.

The LS provides a number of services that allow for the acquisition, processing, and dissemination of information. Text, binary, graphics, Web, and model are common data sets that are ingested or disseminated.

### 8.3 *LDAD Software Configuration*

AWIPS II provides an interface with the existing Message Handling System (MHS). This allows products, including product reshops transmitted via the LAN, to be fed to EDEX for ingest/processing. The LDAD-to-EDEX bridge is provided via three LDAD routers – routerStoreEDEX, routerShefEncoderEDEX, and routerStoreTextEDEX – which run as part of LDAD on px2f. It is important to note that AWIPS II has not changed the design and functionality of LDAD; the only change is the addition of routers to bridge the gap from LDAD to EDEX.

The flow of LDAD data to EDEX is shown in Exhibit 8.3-1.

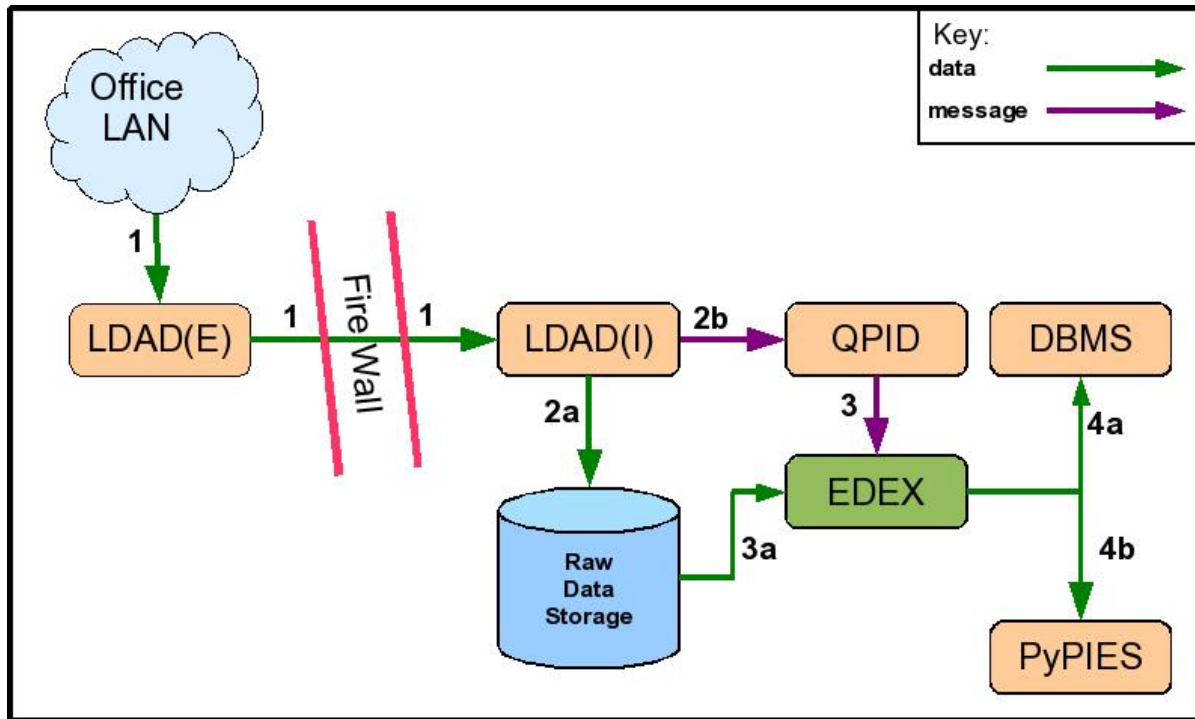

Exhibit 8.3-1. Flow of LDAD Data to EDEX

As shown in Exhibit 8.3-1:

1. Data from the office LAN is received by LDAD(E- External to the Firewall on the LS servers ) and passed through the firewall LDAD(I -Internal to the Firewall on the PX servers).

**Note:** The LDAD(E) software runs on the LS servers. The LDAD(I) software runs on the PX servers.

2. The internal LDAD(I) software performs two operations on the data it receives:
  - a. LDAD(I) writes the data as a file to Raw Data Storage.
  - b. LDAD(I) posts a “data available” message to the QPID message broker.
3. The EDEX Ingest process obtains the “data available” message from QPID and determines the data decoder to use to ingest the data.
  - a. The data decoder reads the raw data from Raw Data Storage and decodes it.
4. Once decoded, the data is persisted for later retrieval.
  - a. The data is sent to the DBMS.
    - i. Information about the data is persisted to the AWIPS II metadata database.
    - ii. Some types of data (for example, text products) are written to tables in the AWIPS II database.

- b. Certain types of data (satellite imagery, radar imagery, GRIB data, and certain point data) are written to HDF5 files in Processed Data Storage. This is performed via the PyPIES process on DX1/2.

**Note:** In some cases, EDEX will automatically run scripts on arrival of the data.

Note that AWIPS II does not change the flow of data to the PX server. Normal data verification procedures may be used to follow the data to the PX servers. Once the data is passed to EDEX, the same techniques used to trace the SBN data flow from EDEX to Processed Data Storage may be used for LDAD delivered data.

### 8.3.1 LDAD Gateway

The LDAD Gateway is a set of software components that together make up the core data acquisition and dissemination mechanism of the AWIPS LDAD. The Gateway is distributed over the LS and the PX, on both the internal and external sides of the firewall. The LDAD Gateway software links the internal and external sides of LDAD together, controlling the transfer of information across the firewall. Table 8.3.1-1 lists LDAD environmental variables and their paths. Exhibit 8.3.1-1 shows the generic data flow for acquiring and decoding LDAD products.

Gateway components include the following:

- Scheduler
- Communications Server (CO)
- Inter-Gateway Communication (IGC)
- Preprocessors
- Decoder and Storage
- Trigger
- Quality Control (QC)
- Fax.

**Table 8.3.1-1. LDAD Environment Variables on LDAD Cluster (LS) and/or PX1, PX2**

LDAD Environment Variable Name	LDAD Environment Variable Path (as user fxa on PX1, PX2)
LDAD_HOME	/awips/fxa/ldad
LDAD_INTERNAL_HOME	/awips/ldad
LOG_DIR	/data/logs/fxa
LDAD_INTERNAL_LOGDIR	/awips/fxa/ldad/logs
LDAD_EXTERNAL_LOGDIR	/data/logs/ldad
LDAD_DATA	/data/fxa/LDAD
LDAD_INTERNAL_DATA	/awips/fxa/ldad/data
LDAD_EXTERNAL_DATA	/data/ldad
LDAD_DECODED_DATA	/data/fxa/LDAD/decoded

Config Files:

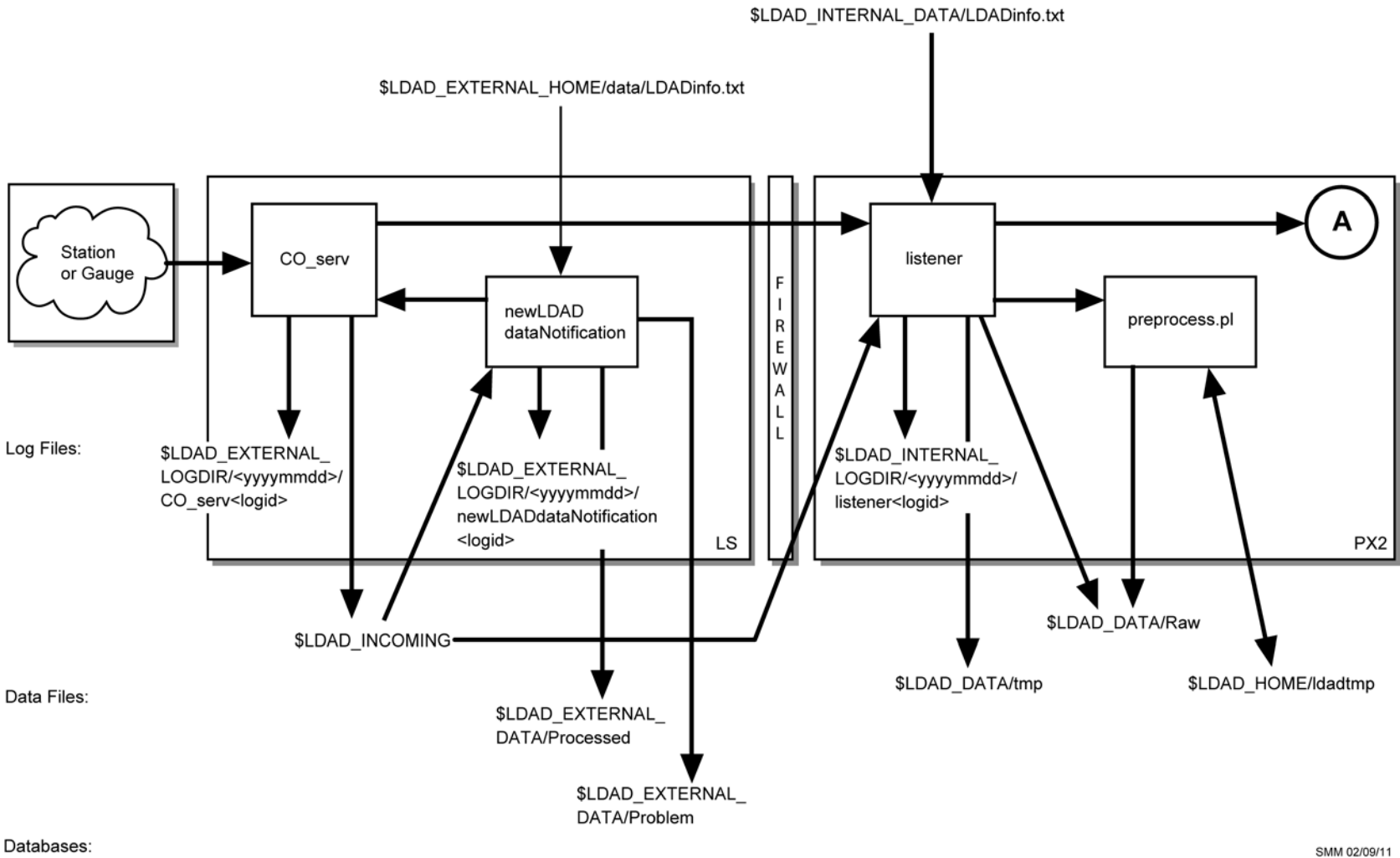

SMM 02/09/11

Exhibit 8.3.1-1. Generic Acquire and Decode LDAD Product (Page 1 of 2)



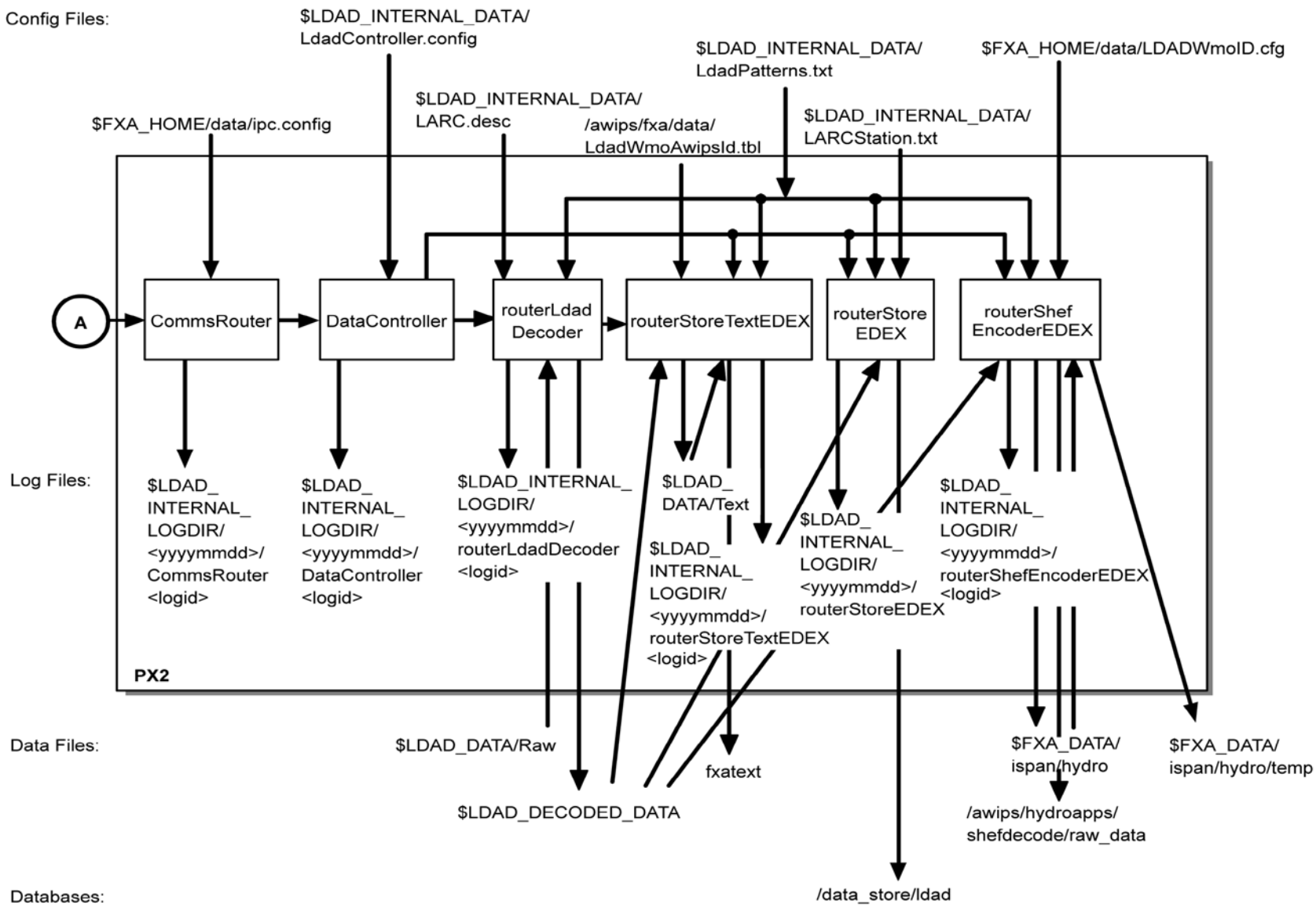

SMM 07/13/10

Exhibit 8.3.1-1. Generic Acquire and Decode LDAD Product (Page 2 of 2)

New products coming into LDAD are placed into the **/data/Incoming** directory on the active LS machine. The **newLDADdataNotification** and **CO\_serv** processes on the LS notify the **listener** process on the PX2 when a new product is available. The **listener** process transfers the file through the firewall, puts the copy on the PX2 in the **\$LDAD\_DATA/tmp** directory, and notifies **CO\_serv** and **newLDADdataNotification** that the transfer has been completed. Once this notification has been received, **newLDADdataNotification** moves the original product from **/data/Incoming** to **/data/ldad/Processed**. If **newLDADdataNotification** fails to receive confirmation from the **listener** process within 5 minutes, it moves the file to the **/data/ldad/Problem** directory. If the file requires preprocessing, the **listener** process copies the file into the **\$LDAD\_DATA/tmp** directory and checks the **\$LDAD\_DATA/data/LDADinfo.txt** file to specify the preprocessor to call for that particular product type. The file is copied to the **\$LDAD\_HOME/tmp** directory, where it is reformatted by the preprocessor and stored in the **\$LDAD\_DATA/Raw** directory on the PX2. If the file requires no preprocessing, the **listener** moves the file directly into the **\$LDAD\_DATA/Raw** directory and sends a notification to the **CommsRouter** that a product has been preprocessed. The **CommsRouter** passes the information to the **DataController**, which in turn passes the information to the **routerLdadDecoder**. The **routerLdadDecoder** decodes all files in the **\$LDAD\_DATA/Raw** directory and writes them via serialized data files to the **\$LDAD\_DECODED\_DATA** directory. Data that is processed, but not recognized are written to **\$FXA\_DATA/LDAD/Unknown**. Bad data are written to the **\$FXA\_DATA/LDAD/Bad** directory. The **routerStoreEDEX** process reads the files in the **\$LDAD\_DECODED\_DATA** directory, converts those files that match the criteria in the **LdadPatterns.txt** file into an XML format, stores the converted data into the **/data\_store/ldad** directory, and sends a notification to EDEX.

**NOTE:** The **\$LDAD\_DATA/tmp** directory on the PX2 works much the same as **/data/Incoming** on the LS; it serves as a temporary location for the file while it is being processed. So, any given file should remain in **\$LDAD\_DATA/tmp** for only the relatively short period of time that it is being processed. Once processing is complete, the file should be moved to its destination. The **\$LDAD\_DATA/tmp** directory is purged once per day, so if it contains many files, the accumulated files may fill up the **/data/fxa** partition. The LDAD software was designed so that the preprocessor will either delete or move the temporary files from the **\$LDAD\_DATA/tmp** directory once it completes its processing. The preprocessors that are delivered with the baselined AWIPS software remove these files. However, sites that have written their own preprocessors for specialized data types may have preprocessors that fail to clean the temporary files out of the **\$LDAD\_DATA/tmp** directory when they finish.

### 8.3.2 Scheduler

The Scheduler's function is to perform specified data acquisition/dissemination events automatically at specified time intervals (in the background via the **ldadServer** process).

The Scheduler invokes scripts to acquire/disseminate from/to remote hosts by ftp, kermit, xmodem, ymodem, or zmodem, or automatically dials selected LARC, Handar 555, Campbell, or Sutron gauges for data at specific intervals. Configuration, manipulation, and activation of the Scheduler are accomplished via the Scheduler's own edit menus.

The Scheduler also provides the forecaster access to the LDAD Gateway. Through this Tcl/Tk interface, the AWIPS user can start and stop the LDAD Gateway automatic processes, incorporate new types of data sources into the system, set up operating environments for external users, and initiate data acquisition on demand from an external source (e.g., a LARC gauge).

Using the Scheduler, the user can create or modify session files. These are simple, text-based files that the communications server (**CO\_serv**) program reads and translates into the appropriate commands to execute a data transfer acquisition session with a remote source (e.g., a LARC gauge).

The Scheduler can be started from any workstation from the Cave **Obs** menu, Collection/Dissemination. Refer to the *AWIPS II CAVE-D2D User's Manual* for additional information.

### 8.3.3 *Communications Server*

The Communications Server (CO) component is used by the other components to interface with the communication hardware; that is, the terminal server and modems. The CO uses information from the Scheduler and the session files for configuring dial-out parameters, defining the data, etc. The CO program, **CO\_serv**, calls the script that performs the function. **CO\_serv** is the external end of the IGC described in the next section.

### 8.3.4 *Inter-Gateway Communication*

The IGC function provides a communications link across the firewall between the internal and external sides of the Gateway. This link or Interprocess Communication (IPC) is handled by sockets, an IPC interface that allows communication across the firewall using TIS's TCP proxy. On the PX2, a process called **listener** is the point of contact for all communications between processes on the internal system (PX) and the external system (active LS), where the **CO\_serv** acts as the point of contact. All communications between the PX and the LS use the **CO\_serv-listener** pair.

The firewall is configured to allow socket communication to a single specified port from only the LS on the external system.

### 8.3.5 *Local Data Management*

Local Data Management (LDM) is a software package that is designed to select, capture, process, and distribute data products using client/server programs. The LDM software

used for the LDAD servers is copyrighted by the University Corporation of Atmospheric Research (UCAR) in Boulder, CO. Each regional headquarters has an LDM *Server* that receives data from the Meteorological Assimilation Data Ingest System (MADIS). The data is then disseminated via the internet to the LDAD *clients* that are configured to receive LDM data. Once the data is received by LDAD, it is treated like any other LDAD product.

LDM is being used only for LDAD products that are requested from MADIS. This means that the ls2 and ls3 must be configured to ingest the products, and the px1 and px2 must be configured to process the products. Please note, for failover purposes, the ls2/ls3 must have the same LDM configuration and px1/px2 must have the same preprocessors, stations files, description files, etc. See Exhibit 8.3.5-1.

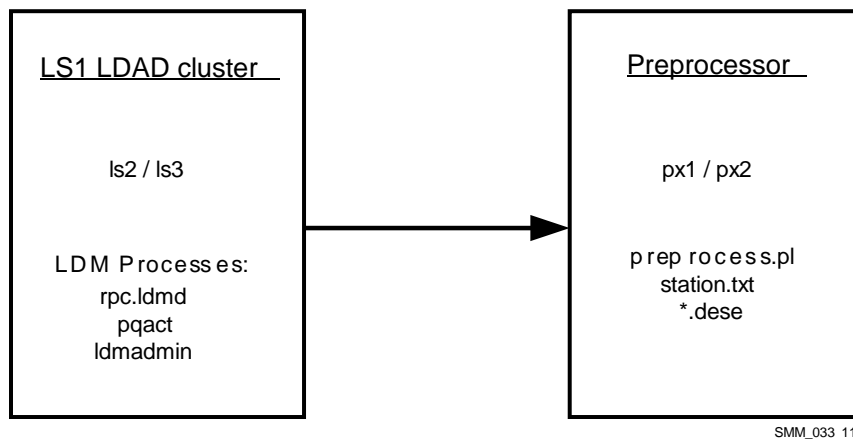

Exhibit 8.3.5-1. LDM Ingest

### 8.3.6 Preprocessors

When the **listener** on the PX2 receives a message that a new data file is available on the active LS, it immediately secure copies the file over to the **\$LDAD\_DATA/tmp** directory. The **listener** then checks the **\$LDAD\_DATA/data/LDADinfo.text** file to identify the preprocessor script that is required for the data file received. If any preprocessing for that data file is necessary, the appropriate preprocessor is called to reformat the file for the decoder, and is stored in **\$LDAD\_DATA/Raw**.

The preprocessors are located in the **/awips/fxa/ldad/bin** directory. The preprocessors can be written in any programming or scripting language. The only requirement is that they are executable. Sample preprocessors are installed during installation. These preprocessors were generated for generic data sets and should be treated as site-configurable. There is a potential need for many preprocessors, one for every data type. The objective is to remove the need for preprocessors by having the data providers send files in the required format.

### 8.3.7 *Decoder and Storage*

The decoder module checks the **\$LDAD\_DATA/Raw** data directory for new data sets at 1-minute intervals. If any are found, it decodes them using information from the metadata files. Using the information in the description files (**\*desc** files), the decoder evaluates each column of data by checking for the hydrometeorological variable, the incoming units, and the storage units. After the decoding is complete, the decoder creates a data object with all the data and calls the storage module. The storage module reads the station file (**\*Station.txt** file) for static station information such as latitude, longitude, and elevation. It stores the station information and data from the decoder into a netCDF and possibly a Standard Hydrometeorological Exchange Format (SHEF)-encoded file. The decoder process runs continuously.

## 8.4 *Rsync*

Rsync has been preconfigured on the LDAD Servers. This document details the baseline configuration of the rsync implementation on the LDAD Servers. Note that as delivered, rsync cron jobs loaded onto LS2/LS3 are syncing a few directories between the two servers. Sites may wish to alter this configuration, adding more directories to be synced or removing some that are being synced. Rsync is site configurable.

The baseline implementation of rsync consists of an rsync process initiated by root cron jobs `/var/spool/cron` and is limited to syncing directories between the two servers (LS2/3). The three `/var/spool/cron/` rsync entries are as follows:

```
/ldad/bin/rsync_cron.sh ldad
/ldad/bin/rsync_cron.sh ldm
/ldad/bin/rsync_cron.sh root
```

The directories being synchronized between the two servers are:

- **/home** – The rsync syntax compares the `/home` directories of LS2/3 and saves the latest version of the files to `/data/Backup` directory.
- **/usr/local/ldm/data** – This synchronization is triggered by the “ldm” cron entry and synchronized the data in the `/usr/local/ldm/data` directory.

### 8.4.1 *Rsync with AWIPS (internal) and External (non-AWIPS) Systems*

The LDAD servers use rsync to communicate with external hosts such as web farms; and receive internal rsync connections from DX1/2 (and other AWIPS servers) in support of other programs such as AHPS. The AWIPS to LDAD rsync processes are achieved by utilizing the “-ssh” switch on rsync. Sites do not have to alter this configuration in order to initiate rsync connections from AWIPS to LS2/3 when using the “-ssh” implementation. Sites may need to modify the rsync configuration files to include external server IP Addresses assuming the “-ssh” switch is NOT being used to connect to these servers. Example of using the “ssh” switch with rsync for internal to LDAD rsync communications:

```
rsync -auvv -e ssh -timeout=120 <file name> ldad@ls1:/tmp
```

### 8.4.2 Rsync Configuration Files

The following rsync files have been verified, modified, or added to the baseline:

/rsync_install.sh	(rsync initial setup script)
/etc/rsyncd.conf	(rsync daemon config file)
/etc/services	rsync tcp port assignment config file)
/etc/xinetd.d/rsync	(rsync daemon control file)
/etc/sysconfig/iptables-config	(netfilter saved configuration file)
/etc/sysconfig/ip6tables-config	
/ldad/bin/rsync_cron.sh	(cronjob script)

### 8.5 LDAD Linux Server Heartbeat Cron Package

The Heartbeat and the Cron files managed by the heartbeat package are configured on the LDAD Servers (LS2/LS3) in a manner similar to its implementation on the other AWIPS systems. Details of its implementation and procedures to localize the configuration for sites are presented in this section:

#### Key Directories:

- **/etc/ha.d/cron.d** - This directory contains two files, lscron and SITElscron. Sites should use the SITElscron file to add their local cron jobs that need to be managed by the heartbeat package.
- **/etc/ha.d/resource.d** - This directory contains the file “Crontab” which is a resource added to the /etc/ha.d/haresources file. This heartbeat resource file is responsible of starting the cron file listed in /etc/ha.d/cron.d. This file also copies the files listed in /etc/ha.d/cron.d to the /etc/cron.d directory at heartbeat startup. This script can also be run manually from the command line to check status. For example, as root on LS2, type the following from the command line:

```
/etc/ha.d/resource.d/Crontab <cronfile name> status
```

(where *cronfile name* could be the baseline SITElscron file name).

- **/var/spool/cron** - This directory is the standard location for user cronfiles and can still be used by sites. Baseline configuration has two cron jobs running on LS2/LS3 and they consist of the following:

**ldm:** One entry running the /usr/local/ldm/bin/scour script.

**ldad:** Runs scour daily to clean up log files

```
0,30 * * * * ldad /home/AAS/test/vdot.sh
```

```
15 * * * * ldad /home/AAS/test/vdot2.sh
```

```
45 * * * * ldad /home/AAS/test/vdot3.sh
```

```
30 0 * * * csh -c '${LDAD_HOME}/bin/startScour.sh >&!
```

```
/data/logs/ldad/startScour.log'
```

## Heartbeat Status

The LDAD servers are configured in a clustered pair. Only one server is actively running the heartbeat package at a given time, and it will be the one reachable through the address 192.168.1.10 (“ls1”) via the LDAD LAN switch. If the primary server loses network connectivity or had failed, the other server will take over the 192.168.1.10 ipaddress and all the LDAD processes. The **hb\_stat** command can be used to determine which server is providing LDAD functionality. Notice the ipaddress configuration:

```
[root@ls2-ntcb ~]# hb_stat

Heartbeat Status Monitor                               Apr 23 21:49:08

===== M e m b e r   S t a t u s =====

  Member          Status      IP address
  -----
  ls2-tbdw        Up          192.168.1.11
  ls3-tbdw        Up          192.168.1.12

===== R e s o u r c e   S t a t u s =====

  Resource          Parameters          Owner      Status      Start Time
  -----
  IPaddr2           192.168.1.10/24/eth0  ls2-tbdw  Running OK  2012-04-12 18:14:47
  LS1IPSRCaddr      ls2-tbdw            OK        2012-04-12 18:14:47
  apache            ls2-tbdw            Running OK  2012-04-12 18:14:49
  csportd           ls2-tbdw            OK        2012-04-12 18:14:53
  Xinetd            wu_ftp              ls2-tbdw  Running OK  2012-04-12 18:14:53
  hylafax           ls2-tbdw            OK        2012-04-12 18:14:54
  ldad              ls2-tbdw            OK        2012-04-12 18:14:55
  dserver           ls2-tbdw            OK        2012-04-12 18:15:28
  Crontab           SITElscron          ls2-tbdw  OK        2012-04-12 18:15:28
  Crontab           lscron              ls2-tbdw  OK        2012-04-12 18:15:28
  SITEprocesses    ls2-tbdw            OK        2012-04-12 18:15:29

HylaFAX Details:
HylaFAX client-server protocol server: hfaxd (pid 32423) is running...
HylaFAX queue manager process: faxq (pid 32420) is running...
```

## ACTIVE LDAD Processes

The active LDAD server will have processes running similar to those listed below, depending on how the server is configured

```
ls2-ntcb{ldad}49: ps -ef | grep nobody
nobody    heartbeat: FIFO reader
nobody    heartbeat: write: ucast eth1
nobody    heartbeat: read: ucast eth1
nobody    heartbeat: write: ping 192.168.1.1
nobody    heartbeat: read: ping 192.168.1.1

ls2-tbw3{ldad}50: ps -ef | grep ldad
ldad      11680    1 0 May30 ?        00:00:05 /ldad/bin/CO_serv
ldad      11683    1 0 May30 ?        00:00:00
/ldad/bin/newLDADdataNotification
ldad      11684    1 1 May30 ?        17:01:07 /bin/bash /ldad/bin/hmingestd
ldad      11687    1 0 May30 ?        00:00:00 /usr/bin/perl
/ldad/bin/MakeLDAPage /ldad/data/lda.conf
```

```

ldad      11688      1  0 May30 ?          00:00:00 /usr/bin/perl
/ldad/bin/MakeLDAPage /ldad/data/ldd.conf
ldad      11691      1  0 May30 ?          00:01:05 /usr/bin/perl
/ldad/bin/MakePROCpage /ldad/data/proc_external.conf
ldad      11801      1  0 May30 ?          00:00:00 /ldad/bin/ROSA_Acq PAD
/dev/rosamodem1
ldad      11893      1  0 May30 ?          00:00:00 /ldad/bin/suaReceiver
/dev/suamodem2
ldad      11894      1  0 May30 ?          00:00:00 /ldad/bin/suaReceiver
/dev/suamodem1
ldad      13038      1  0 May26 ?          00:00:00 /usr/bin/perl -w
/ldad/bin/DServer start
ldad      14693      1  0 May30 ?          00:08:51 /bin/sh
/ldad/bin/watchDogExternal.sh
ldad      15539 14693  0 19:51 ?          00:00:00 sleep 60
ldad      15560 13038  0 May26 ?          00:00:00 /usr/bin/perl
/ldad/bin/diss_server.pl

ls2-ntcb{ldad}51: ps -ef | grep ldm
ldm      pqexpire
ldm      pqact
ldm      rpc.ldmd -P 388 -q /usr/local/ldm/data/ldm.pq
/usr/local/ldm/etc/ldmd.conf
ldm      rpc.ldmd -P 388 -q /usr/local/ldm/data/ldm.pq
/usr/local/ldm/etc/ldmd.conf

```

## INACTIVE LDAD Processes

The inactive LDAD server will only have the heartbeat processes running, checking for connectivity to the other LDAD server. If connectivity is lost, the inactive server becomes the active server:

```

[root@ls3-ntcb ~]# ps -ef | grep nobody
nobody   heartbeat: FIFO reader
nobody   heartbeat: write: ucast eth1
nobody   heartbeat: read: ucast eth1
nobody   heartbeat: write: ping 192.168.1.1
nobody   heartbeat: read: ping 192.168.1.1

[root@ls3-ntcb ~]# ps -ef | grep ldad
root     21317 21280  0 15:32 pts/0    00:00:00 grep ldad

[root@ls3-ntcb ~]# ps -ef | grep ldm
root     21313 21280  0 15:32 pts/0    00:00:00 grep ldm

```

## 8.6 Quality Control and System Monitoring

This section describes the Quality Control and System Monitoring.

### 8.6.1 Quality Control

LDAD observations are quality controlled by the AWIPS Quality Control and Monitoring System (QCMS), which in turn relies on the MAPS Surface Analysis System (MSAS) to perform automated quality control checks. MSAS/QCMS is a multischeduled system with four main subprocesses. Each subprocess runs independently based on the following crontab entries on PXs:

- The **model ingest cycle** runs twice a day.



- The **subhourly QC cycle** runs every 5 minutes.
- The hourly **QC/analysis cycle** runs immediately after the **xx:18** subhourly run.
- The **QC summary programs** run near 00Z.

The QCMS is only a partial implementation of the overall requirements for the quality control of surface observations. The subhourly processing checks the validity, internal consistency, and temporal consistency of LDAD Mesonet observations of sea-level pressure, temperature, dewpoint temperature, wind, station pressure, altimeter setting, pressure change, relative humidity, visibility, and precipitation observations. The hourly QC process checks the validity, internal consistency, temporal consistency, and spatial consistency of LDAD Mesonet and NOAAPORT observations of sea-level pressure, temperature, wind, and dewpoint temperature. WFO personnel can override the results of the automated QC checks.

Two text files, `/data/fxa/LDAD/fslparms/reject.txt` and `accept.txt`, reside on the DX Network Attached Storage (NAS), a shared directory, to provide the capability to subjectively override the results of the automated QC checks. The reject list is a list of stations and associated input observations that will be labeled as bad, regardless of the outcome of the QC checks; the Accept list is the corresponding list of stations that will always be labeled as good. Applications reading the lists (e.g., MSAS) will reject or accept the specified stations. In both cases, observations associated with the stations in the lists can either be flagged individually, or be flagged in groups.

The QCMS station monitoring procedures and text summary files are not affected by the intervention lists. This allows WFO personnel to continue to monitor the performance of the stations contained in the reject and accept lists. For example, a user may notice that a station has wind observations that fail the QC checks a large percentage of the time, and choose to have that station added to the reject list. However, once the observation failure rate at the station falls back to near zero (possibly due to anemometer repair), the station can be deleted from the list.

QCMS reject and accept lists may be edited by hand (with any text editor), or through the LDAD Monitoring and Control System (see next section for additional information). For each station, both station and provider names are required. Provider names are found in the `/data/fxa/LDAD/fslparms/sfchqc.in.dat` file. The first seven entries (SAO, MARITIME, COOP, OTHER-MTR, ASOS, NWSRAWS, UTMESNET) are national data sets, and always appear. Any others are added dynamically by the 5-minute QC program, `qcstg1_2`, based on `dataProvider` names found in `/data/fxa/LDAD/mesonet/netCDF` files (LDAD-collected data). A blank provider name is allowed, but it may result in multiple stations with the specified station name being rejected or accepted (e.g., when different data providers use the same station name).

The QCMS also provides the capability to accept or reject observations from all stations with a specified provider name. To utilize this option, fill in the provider and observation columns, but leave the **StaID** column blank.

The QCMS also calculates hourly, daily, weekly, and monthly statistics on the frequency and magnitude of the observational errors encountered for sea-level pressure, temperature, dewpoint, and surface winds. It processes both NOAAPORT and LDAD Mesonet observations.

QCMS summary files are stored in the text database. Files are named **<nnn>QC[HDWM]<LLL>**, where **<nnn>** is a three-digit number (leading zeros) corresponding to a data set's ordinal position in **/data/fxa/LDAD/fslparms/sfchqc.in.dat** (e.g., NPN is 003); **H** is for hourly QC summaries, **D** for daily, **W** for weekly, and **M** for monthly; and **<LLL>** is the localization ID.

QCMS generates status messages for up to 20 providers. If more than 20 providers are found in the netCDF files, all additional providers' QC information will be lumped into **000QC[HDWM]<LLL>** files.

### 8.6.2 System Monitoring

The LDAD System Monitor and Control System is a Web-based function that allows the site to monitor the LDAD system connectivity, processes, and acquisition/dissemination status. The LDAD System Monitor checks on all LDAD processes, systems, and data to provide a visual status of LDAD performance. The LDAD Monitor Summary page is linked to the AWIPS System Monitor. The LDAD Monitor Summary page summarizes all LDAD Monitor pages and provides an interface for system administration.

The Summary Monitor application, **MakeSUMMpage**, runs on PX1 and uses the configuration file **~ldad/data/summary.conf** for various parameters, including the monitor pages. The Internal Process and System page comes from PX1, while the other three (Data Acquisition, Data Dissemination, and External Process and System) are retrieved via HTTP protocol from active LS. By default, the monitor updates every 5 minutes. If any of the pages is out of date (i.e., older than the **Run\_interval** specified in the **summary.conf** file), the **MakeSUMMpage** will not generate its line on the summary.

The overall/summary state of each submonitor is displayed on the left with the standard state icons. On the right are four columns, designated R, Y, B, G for Red, Yellow, Blue, and Green, respectively. The numbers below the column represent the number of items that are in each of the states for each submonitor. This gives the site administrator some indication of the relative problem and allows for prioritization for problem solving. (If any item is in ? state [e.g., a data file is not found], it does not register in any column.)

There are two Process and System pages, Internal and External, each of which displays the state of all appropriate LDAD processes and hardware systems. These pages are intended to be used primarily by the LDAD site administrator. The following three tables are on each page:

**Processes:** Displays the state of all LDAD processes on the active LS, or PXs

- Systems:** Displays the state of all internal or external LDAD systems
- Network:** Displays the state of all LDAD network systems (Gateway, Firewall, Terminal Server, etc.)

The LDAD site administrator can start/stop processes, edit system configuration files, etc.

## 8.7 Acquire LARC/Handar 555 Data

Data collection from LARC/Handar 555 gauges is carried out by automating a normally interactive session using the **cu** communication protocol. There is a Server program (**CO\_serv**) and a Client program (**tell\_co**). The Server program is always running, waiting for and processing requests to collect data from a particular gauge from the Client program. The Client program can be invoked from a shell script, as a cron job, or directly from a user prompt. A feature of the Client program is that it retrieves all necessary information regarding collection and storage of data from system tables in the AWIPS database. The Client and Server programs use sockets to communicate across a TCP/IP LAN. Data from a gauge are SHEF-encoded before storage on AWIPS.

### Processes

```
LS    process_expect
LS    CO_serv
PX2   listener
PX2   tell_co
PX2   ldadServer
LX    ldadScheduler
```

### Environment Variables

```
$LOG_DIR           /data/logs/fxa (as user fxa on the PX1, PX2)
                  /data/logs/ldad (on the active LS or as user ldad on the
                  PX2, PX1)
$LDAD_INTERNAL_DATA /data/fxa/LDAD/data as user ldad and
                  /awips/fxa/LDAD/data as user fxa
$LDAD_EXTERNAL_LOGDIR /data/logs/ldad (as user ldad)
$LDAD_INTERNAL_LOGDIR /data/logs/ldad (as user fxa)
                  /data/logs/ldad (as user ldad)
```

**Note:** The Environment Variables above apply to all exhibits in this chapter.

### Configuration Files (all in /data/fxa/LDAD/data)

```
LDADinfo.txt      (for listener)
LARCStation.txt   (for tell_co)
userDescriptions  (for ldadScheduler)
usrpro            (for ldadScheduler)
gageinfo          (for ldadScheduler)
gaugeDescriptions (for ldadScheduler)
userSessList      (for ldadScheduler)
```

gaugeSessList (for **ldadScheduler**)

### **LDADinfo.txt**

The file should contain the following entry:

```
LARC | LARC | 89 | 90 | CVS_TYPE | hydro | preProcessLDAD.pl |
```

The **preProcessLDAD.pl** script must be located in the **/awips/fxa/ldad/** directory. Once the file is installed, this line should not be modified.

### **LARCStation.txt**

This file must be updated whenever a gauge is added to or dropped from the current LARC/Handar 555 datalogger list. To add a new LARC/Handar 555 gauge, find out the following gauge information to create a new entry in the station table format (\* indicates a mandatory field):

- **Provider ID:** Data provider station ID (\*)
- **AFOS(HB5) ID:** The AFOS or Handbook 5 ID (NWS assigned)
- **Station Name:** Text name of station
- **Elevation:** Station elevation (m) (\*)
- **Latitude:** Station Latitude (decimal degrees, north positive) (\*)
- **Longitude:** Station Longitude (decimal degrees, east positive) (\*)
- **Local Time Zone:** Reporting time zone (e.g., UTC, PST8PDT) (\*)
- **Location Description:** Station location/address (Text)
- **Station Type:** Station type (e.g., tower, surface, floating platform, etc.)
- **Number of Instruments:** Number of reporting instruments for the station
- **Number of Reporting Levels:** Number of data reporting levels. Level information should be provided in the instrument table
- **Maintenance/Calibration Schedule:** Frequency of maintenance/calibration
- **Site Description:** Text description of the site surroundings.

The entries are sorted alphabetically by the gauge ID.

This file must be identical on the PX2 and on the LS machines.

### **userDescriptions**

This file is used by the **ldadScheduler** process to get the descriptions of users. When read in, blank lines and lines beginning with # are skipped. All other lines should have the following format:

<user ID>|<user description>

A blank user description is denoted by having the line end immediately following the | character.

This file should not be modified manually. It should only be written to by the **ldadScheduler** (specifically, the **LdadSchedulerServer.C** routine).

### usrpro

The user file (**usrpro**) is made up of zero to n lines, each line holding the following information (note that the lines are so long that they are wrapped in the interests of readability). Columns containing “??” are not used at this time.

```
<ID>|<protocol>|<IP address>|<phone number>|<login>|<password (encrypted)>|??|<file to receive>|<file to send>|??|??|<data collection session file>|<data dissemination session file>|<local directory>|<remote directory>|??... (columns 16 through 36 have unknown meanings)...|<IP address>|
```

- The <protocol> is either “F” for FTP, “X” for Xmodem, “Y” for Ymodem, “Z” for Zmodem, or “K” for Kermit.
- The <IP address> designates the host to FTP to, if the protocol is “F,” or the terminal server. <IP address> appears in two places in the above column listing: columns 3 and 37. In reality, only one of the two columns is used. For the FTP protocol, only column 3 has the address in it, and column 37 is left blank. If any other protocol is being used, column 37 has the address in it, and column 3 is left blank.
- The <phone number> field is unused if the protocol is “F.”
- The <file to receive> and <file to send> fields are mutually exclusive. Only one may be specified, and the one that is specified also indicates whether this user is a collection user (if <file to receive> is given) or a dissemination user (if <file to send> is given). All other columns are simply tracked when read in; when written out, the same values are placed in them as were originally found.

### gageinfo

The **gageinfo** file contains a list of Handar, LARC, Campbell, and Sutron gauges. It is updated periodically as LARC gauges are added and removed with the **ldadScheduler**. Whenever a gauge is added or dropped from the current list, it should be updated here and in the following files:

```
$LDAD_DATA/data/LARCStation.txt
$LDAD_DATA/data/gaugeDescriptions
```

The following fields must be present for each LARC/Handar 555 gauge:

- **Gauge ID:** A five-character instrument ID.
- **Protocol Type:** C for data collection, D for dissemination.

- **Phone#:** The dial-out phone number can be in any format. However, if the gauge has the voice message first, several pauses are included in the phone number. Depending on the length of the voice message, add more pauses if the one listed here is not enough. The pause is entered by a comma (,) and is ended with a \*9. If a phone number contains a pause extension, make sure the phone number is enclosed by single quotes ('). For example, '1-605.886.2473,,,,,\*9'.
- **Session File:** Use `HANDAR_coll_sess` exactly.

The `HANDAR_coll_sess` will be one of the following:

- **HANDAR\_coll\_session\_1** means gauge provides river stage information only.
- **HANDAR\_coll\_session\_2** means gauge provides total rain information only.
- **HANDAR\_coll\_session\_12** means gauge first provides river stage information then total rain information.
- **HANDAR\_coll\_session\_21** means gauge first provides total rain information then river stage information.
- **HANDAR\_coll\_session\_555** means gauge provides river stage information and/or total rain information.
- **SHEF FILE:** 0=No; 1=Yes.
- **Storage Type:** S.
- **Baud Rate:** Use **9600** for LARC/Handar 555 gauges.
- **Terminal Server (tty):** Use **7e1out** for LARC gauges and **8n1out** for Handar 555.

The fields are separated by vertical bars (|); empty fields are for future use. The number nine (9) in front the phone number allows the user to dial out. An example for a LARC/Handar 555 gauge follows:

```

AENGL|C| |919124365917| | | |HANDAR_coll_sess_1|1|S|9600|e| |7e1out|
SNMCL|C| |93016080977| | | |HANDAR_coll_sess_555|S|9600|e| |8n1out|

```

**NOTE:** The `rcvprog` field indicates the receiving program (e.g., FTP). For data collection, this field is used as the custom gauge ID if the gauge is not owned by the NWS.

### gaugeDescriptions

The file is used to get the site descriptions and should be updated using the **ldadScheduler** when a new LARC/Handar 555 gauge is added. Each entry (line) should have the following format:

```
<gauge ID> | <site description>
```

For example, an entry for the BARW3 would be as follows:

```
BARW3 | Barron, WI
```

The file is sorted by state abbreviations. However, it is displayed based on the alphabetical order of the gauge IDs.

Refer to Exhibit 8.7-1 for the Acquire LARC/Handar 555 data flow diagram.

### 8.7.1 *User Interface: ldadScheduler*

The **ldadScheduler**'s function is to perform certain data acquisition/dissemination events on an automatic basis at specified time intervals (in the background). Access to the Scheduler's functions is via a GUI invoked by selecting **Collection/Dissemination...** from the **Surface** pull-down menu.

The **ldadScheduler** provides a window by which the user may create, view, and manipulate scheduled LDAD requests. It allows the user to create a new request and add it to the request list. The request is activated when submitted to the **ldadServer**, which uses **sendLDADnotification.pl** to create the request. If it is a one-time request (OTR), the user can monitor its progress via a status dialog.

The **ldadScheduler** registers with the **ldadServer** providing a callback routine for update notifications. The session file contents get registered first, and the status messages and ID updates so that when registering with **ldadServer**, the ID lists sent by **ldadServer** will be caught and kept. It also registers with the File Access Controller (FAC) for notifications of changes to the existing requests file, and creates a FAC lock for the file to be used for locking it for "reads" and "writes." The existing requests get read so as to fill the tree view with the requests that have been created.

### 8.7.2 *ldadServer*

The **ldadServer** allows multiple clients to connect to it and submit requests with intervals and durations that are honored according to their intervals until they expire.

New client initialization is performed by sending the gauge and user lists to the newly registered client. The **ldadServer** process creates a new message with the current active list and broadcasts it to all registered clients.

To honor the specified request, the **ldadServer** creates the command to be executed.

The **ldadServer** process receives LDAD messages from clients; messages to create and delete gauges and users; and messages requesting the contents of a session file, or specifying a session file's contents.

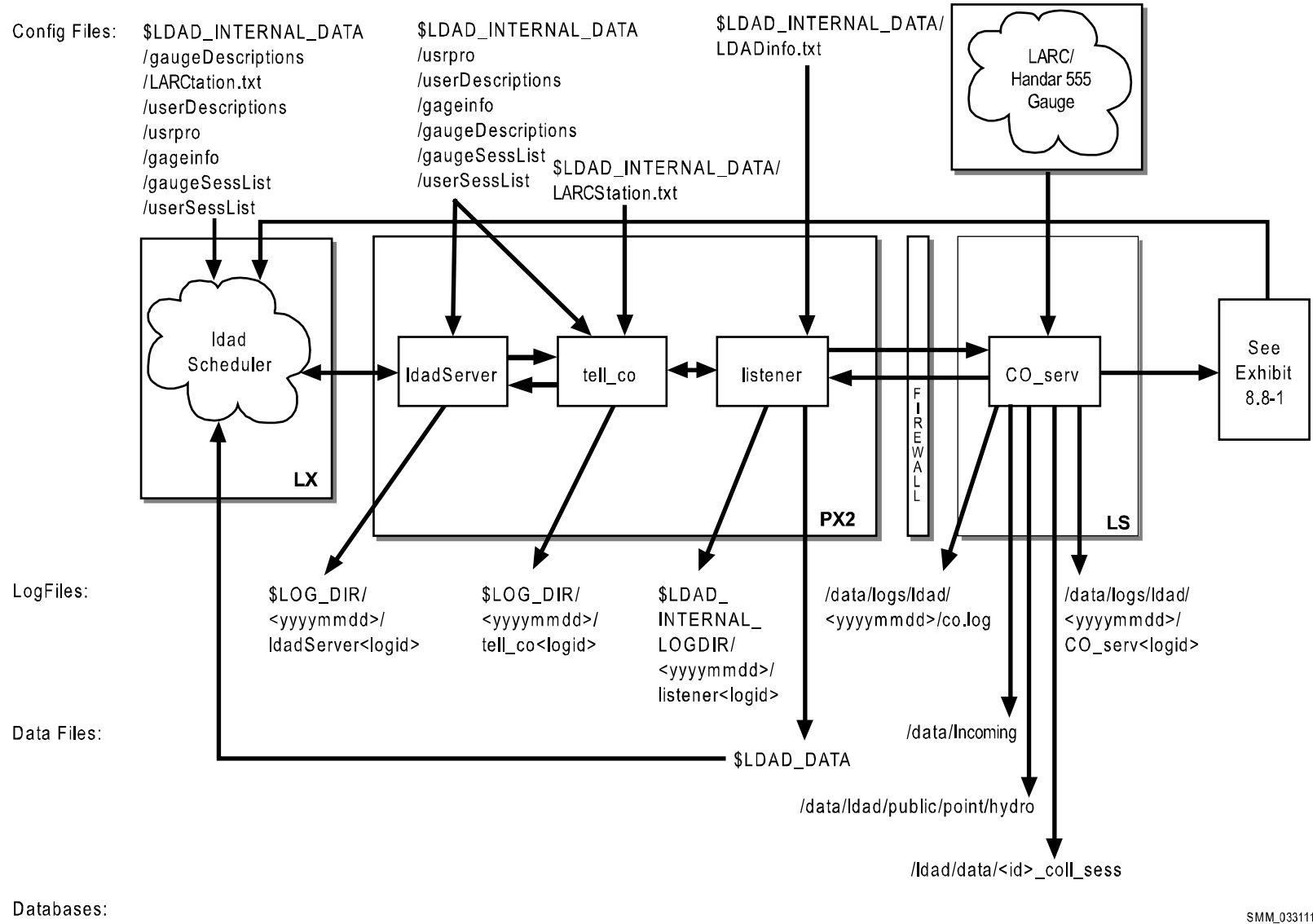

SMM\_033111

**Exhibit 8.7-1. Acquire LARC/Handar 555 Data (for LDAD)**



► **To Access and Read the ldadServer Log**

The **ldadServer** log resides on the PX2 in the **\$LOG\_DIR** directory, and records messages from the process. Perform the following commands as user **ldad**:

**TYPE:**        `cd $LOG_DIR/<yyyymmdd>`  
                   ▪        Where **<yyyymmdd>** is today's date.

**TYPE:**        `ls -ltr ldadServer*`  
                   ▪        Displays the **ldadServer** logs from earliest to latest.

**TYPE:**        `tail -f <logname>`  
                   ▪        Displays the latest registered messages as the log updates.

**Log Message Format**

An entry at the beginning of the log looks like the following:

```
LOG-STATUS: Log file opened on host px2-rnk at Jul 12 14:28:29 2010
00:18:59.602 DataSocket.C PROBLEM: Reconnect attempt to lx1-rnk/4813/10733
failed.
00:18:59.765 DataSocket.C DEBUG: Closing the socket to lx1-rnk/4813/10733
00:18:59.766 DataSocket.C DEBUG: Creating a new object to read an orphaned
socket.
00:18:59.766 ParameterizedMsg.C EVENT: Send of IPC message failed; Target not
available.
Target: lx1-rnk/4813/10733
Module: 35
Type: 10
00:18:59.786 ParameterizedMsg.C EVENT: Send of IPC message failed; Target not
available.
Target: lx1-rnk/4813/10733
Module: 35
Type: 8
00:18:59.789 DataSocket.C DEBUG: Connection to unknown IPC address has been
closed by the peer.
00:18:59.790 DataSocket.C DEBUG: Closing the socket to unknown IPC address
```

The format of the log consists of the following fields:

```
Time stamp            00:18:59.602
File name             DataSocket.C
Message type          PROBLEM:
Message string        Reconnect attempt to lx1-rnk/4813/10733 failed.
```

Here is another example that warns of a wrong host.

```
LOG-STATUS: Log file opened on host px2-tbw3 at Mon Jul 12 14:29:48
2010
14:29:48.862 Connection.C EVENT: WARNING: this process wants to use
target LDAD_SCHEDULE_SERVER which is assigned to run on px2f-tbw3
but the current host is px2-tbw3
14:29:48.936 LdadSchedulerServer.C PROBLEM: Bad formatting in gauge
file "/awips/fxa/ldad/data/gageinfo" on line 1. Skipping a gauge.
14:29:48.936 LdadSchedulerServer.C PROBLEM: Bad formatting in gauge
```

```
file "/awips/fxa/ldad/data/gageinfo" on line 2. Skipping a gauge.
14:29:48.936 LdadSchedulerServer.C PROBLEM: Bad formatting in gauge
file "/awips/fxa/ldad/data/gageinfo" on line 3. Skipping a gauge.
14:29:48.936 LdadSchedulerServer.C PROBLEM: Bad formatting in gauge
file "/awips/fxa/ldad/data/gageinfo" on line 4. Skipping a gauge.
```

### 8.7.3 *tell\_co*

The Client program (**tell\_co**) retrieves all information concerning a specified gauge from the LDAD configuration files. This includes all communication details, the name of the session file to use, the location to store the data on AWIPS II, and whether SHEF-encoding is required (for LARC/Handar 555 gauges, SHEF-encoding is always required). It formats an interprocess message containing all this information, opens a socket to the **listener**, and sends a get LARC/Handar 555 Message “IPC” message to the **listener**.

#### ► To Access and Read **tell\_co** Log

The **tell\_co** log resides on the PX2 in the **\$LOG\_DIR** directory and records messages from the **tell\_co** process. Perform the following commands as user **ldad**:

```
TYPE:      cd $LOG_DIR/<yyyymmdd>
               ■ Where <yyyymmdd> is today’s date.

TYPE:      ls -ltr tell_co*
               ■ Displays the tell_co logs from earliest to latest.

TYPE:      tail -f <logname>
               ■ Displays the latest registered messages as the log updates.
```

#### Log Message Format

An entry at the beginning of the log looks like the following:

```
LOG-STATUS: Log file opened on host px2-tbdw at Wed May 12 19:45:55 2006
19:45:55.368 doAlivenessTest.c EVENT: waitForReply INTERNAL SUCCESS!!!!...
19:45:56.253 doAlivenessTest.c EVENT: waitForReply EXTERNAL SUCCESS!!!!...
19:45:57.205 tell_co.c EVENT: TELL_CO waitForReply SUCCESS!!!!...
```

The format of the log consists of the following fields:

```
Time stamp      19:45:57.205
File name       tell_co.c
Message type    EVENT:
Message string  TELL_CO waitForReply SUCCESS!!!!...
```

### 8.7.4 *listener*

The **listener** sets up a socket connection, binds to a local address so that the Client (**CO\_serv**) or **tell\_co** can send to it, and waits for the connection. Upon receipt of a data collection request from **tell\_co**, the **listener** forwards information received to the **CO\_serv** process. The **ldadServer** process passes the notification to the **ldadScheduler**,

which (in the case of an OTR) displays the predecoded contents of the data file to the forecaster. The **ldadScheduler** process also receives and displays the LARC/Handar 555 gauge dialing status information.

### ► To Access and Read the listener Log

The **listener** log resides on the PX2 in the directory **\$LOG\_DIR** and records messages from the **listener** process. Perform the following commands as user **ldad**:

- TYPE:** `cd $LOG_DIR/<yyyymmdd>`
- Where **<yyyymmdd>** is today's date.
- TYPE:** `ls -ltr listener*`
- Displays the **listener** logs from earliest to latest.
- TYPE:** `tail -f <logname>`
- Displays the latest registered messages as the log updates.

### Log Message Format

An entry at the beginning of the log looks like the following:

```
20:05:42.447 listener.c EVENT: do_G_Msg: Preprocessor Command Line =
</awips/ldad/bin/preProcessLDAD.pl /data/fxa/LDAD/tmp/alert_r5.dat.1342037141
px2f 15009>
0:02:15.652 listener.c EVENT: rcp_cmd_buf3 = scp
/data/fxa/LDAD/hydro/netCDF/20120711_2000 ls1:/data/ldad/hmIngest/obs-hydro-
local.20120711_2000.1342036934.incoming; ssh ls1 -l ldad "chmod 644
/data/ldad/hmIngest/obs-hydro-local.20120711_2000.1342036934.incoming; mv
/data/ldad/hmIngest/obs-hydro-local.20120711_2000.1342036934.incoming
/data/ldad/hmIngest/obs-hydro-local.20120711_2000.1342036934;
/ldad/bin/sendLDADnotification.pl R \"obs:hydro:local /data/ldad/hmIngest/obs-
hydro-local.20120711_2000.1342036934\" ls1 15007" length = 484
20:05:15.716 listener.c EVENT: child listener: sendLDADnotification completed
for /data/fxa/LDAD/mesonet/qc/20120711_2000
20:05:15.716 listener.c EVENT: rcp_cmd_buf3 = scp
/data/fxa/LDAD/mesonet/qc/20120711_2000 ls1:/data/ldad/hmIngest/obs-qcmesonet-
local.20120711_2000.1342037114.incoming; ssh ls1 -l ldad "chmod 644
/data/ldad/hmIngest/obs-qcmesonet-local.20120711_2000.1342037114.incoming; mv
/data/ldad/hmIngest/obs-qcmesonet-local.20120711_2000.1342037114.incoming
/data/ldad/hmIngest/obs-qcmesonet-local.20120711_2000.1342037114;
/ldad/bin/sendLDADnotification.pl R \"obs:qcmesonet:local
/data/ldad/hmIngest/obs-qcmesonet-local.20120711_2000.1342037114\" ls1 15007"
length = 506
20:05:42.444 listener.c EVENT: do_G_Msg: scp completed for
alert_r5.dat.1342037141
20:05:42.447 listener.c EVENT: do_G_msg: Successfully scp'ed
alert_r5.dat.1342037141, length = 534
20:05:42.447 listener.c EVENT: do_G_Msg: Preprocessor Command Line =
</awips/ldad/bin/preProcessLDAD.pl /data/fxa/LDAD/tmp/alert_r5.dat.1342037141
px2f 15009>
```

The format of the log consists of the following fields:

```

Time stamp      20:05:42.447
File name      listener.c
Message type    EVENT:
Message string  do_G_Msg: Preprocessor Command Line =
                </awips/ldad/bin/preProcessLDAD.pl
                /data/fxa/LDAD/tmp/alert_r5.dat.1342037141 px2f
                15009>

```

### 8.7.5 *CO\_serv*

The Server program (**CO\_serv**) opens a socket and continually listens for connections from the Client program. When one arrives, a child process is spawned that reads the interprocess message, extracts the name of the “session” file (located in **/ldad/data/<id\_coll\_sess>** ) for the gauge in question (LARC/Handar 555), and parses the file to create two temporary files: a response file and a script file. **CO\_serv** uses the **process\_expect** executable (communications protocol **cu**), to call the LARC/Handar 555 gauge. **CO\_serv** stores the LARC/Handar 555 data in the **/data/Incoming** directory and copies the “.eyewash” file to the **/data/ldad/public/point/hydro** directory. **CO\_serv** passes the notification to the **listener**.

#### ► **To Access and Read the CO\_serv Log**

The **CO\_serv** log resides on the active LS in the **\$LOG\_DIR** directory and records messages from the **CO\_serv** process. Perform the following commands as user **ldad**:

- TYPE:**        **cd \$LOG\_DIR/<yyyymmdd>**
- Where **<yyyymmdd>** is today’s date.
- TYPE:**        **ls -ltr CO\_serv\***
- Displays the current day’s **CO\_serv** logs from earliest to latest.
- TYPE:**        **tail -f <logname>**
- Displays the latest registered messages as the log updates.

#### **Log Message Format**

An entry at the beginning of this log looks like the following:

```

22:45:40.215 co_serv_main.c EVENT: CO_serv received a socket
connection at: Apr 23 12 22:45:40 GMT

22:45:40.218 co_serv_main.c EVENT: V message Received by
CO_serv.....

22:50:39.907 co_serv_main.c EVENT: CO_serv received a socket
connection at: Apr 23 12 22:50:39 GMT

22:50:39.911 co_serv_main.c EVENT: G message Received by
CO_serv.....

```

```

22:50:40.201 co_serv_main.c EVENT: CO_serv received a socket
connection at: Apr 23 12 22:50:40 GMT

22:50:40.204 co_serv_main.c EVENT: V message Received by
CO_serv.....

22:55:39.900 co_serv_main.c EVENT: CO_serv received a socket
connection at: Apr 23 12 22:55:39 GMT

22:55:39.903 co_serv_main.c EVENT: G message Received by
CO_serv.....

22:55:40.144 co_serv_main.c EVENT: CO_serv received a socket
connection at: Apr 23 12 22:55:40 GMT

22:55:40.148 co_serv_main.c EVENT: V message Received by
CO_serv.....

```

The format of the log file consists of the following fields:

```

Time stamp          22:45:40.215
File name           co_serv_main.c
Message type        EVENT:
Message string      CO_serv received a socket connection at: Apr 23
                    12 22:45:40 GMT

```

When the processes have performed their duties, notifications are sent to the **notificationServer**, which it passes to the **ldadScheduler**.

**NOTE:** The **process\_expect** executable writes its messages to the **CO\_serv** log.

## 8.8 Decode LARC/Handar 555 Data

The **newLDADdataNotification** script in **\$FXA\_HOME/ldad/bin** checks the LDAD products directory for LARC/Handar 555 files. When a file is present, **newLDADdataNotification** passes the information to the **CO\_serv**, which informs the **listener**. The **listener** executes the **\$FXA\_HOME/ldad/bin/preProcessLDAD.pl** script and calls **routerLdadDecoder** to decode the file. The decoded file is stored and a notification is sent to the user stating that new data are available.

### Processes

```

LS    newLDADdataNotification
LS    CO_serv
PX2   listener
PX2   preProcessLDAD.pl
PX2   CommsRouter LDAD_ROUTER
PX2   DataController LDAD_ROUTER LdadController.config
PX2   routerLdadDecoder
PX2   routerStoreTextEDEX
PX2   routerStoreEDEX
PX2   routerShefEncoderEDEX
PX2   distributeProduct
DX1   notificationServer

```

### Configuration Files /data/fxa/LDAD/data

LDADinfo.txt	(for listener)
*Station.txt	(for routerStoreEDEX)
LdadController.config	(for DataController LDAD_ROUTER)
LdadPatterns.txt	(for routerLdadDecoder, routerStoreEDEX, routerStoreText, routerShefEncoder)
LARC.desc	(for routerLdadDecoder, routerStoreEDEX, routerShefEncoderEDEX)

### Configuration Files in /awips/fxa/data

LdadWmoAwipsId.tbl	(for routerStoreTextEDEX)
LDADWmoID.cfg	(for routerShefEncoder)
edex-info.tx	(for routerStoreEDEX, routerShefEncoderEDEX)

Refer to Exhibit 8.8-1 for the Decode LARC/Handar 555 data flow diagram.

#### 8.8.1 newLDADdataNotification

The **newLDADdataNotification** process uses the file's name to determine the type of data contained in the file and checks the LDAD products directory (**/data/Incoming**) periodically for LARC/Handar 555 files.

The **newLDADdataNotification** process creates and sends an IPC message to the **CO\_serv** process using **createAndSendIPCmessage**. The message notifies **CO\_serv** that there are LARC/Handar 555 files in the **/data/Incoming** directory.

If **newLDADdataNotification** fails to receive confirmation from **listener** within 5 minutes or if an **fstat** on the file to transfer fails, the product gets moved to the **/data/ldad/Problem** directory using the **moveFileToProblemDir** process. Otherwise, the "processed" files are moved to the **/data/ldad/Processed** directory using the **moveFileToProcessedDir** process.

#### ► To Access and Read the newLDADdataNotification Log

The **newLDADdataNotification** log resides on the active LS in the **\$LOG\_DIR** directory and records messages from the **newLDADdataNotification** process. Perform the following commands as user **ldad**:

**TYPE:**        **cd \$LOG\_DIR/<yyyymmdd>**  
                   ▪        Where **<yyyymmdd>** is today's date.

**TYPE:**        **ls -ltr newLDADdataNotification\***  
                   ▪        Displays the current day's **newLDADdataNotification** logs from earliest to latest.

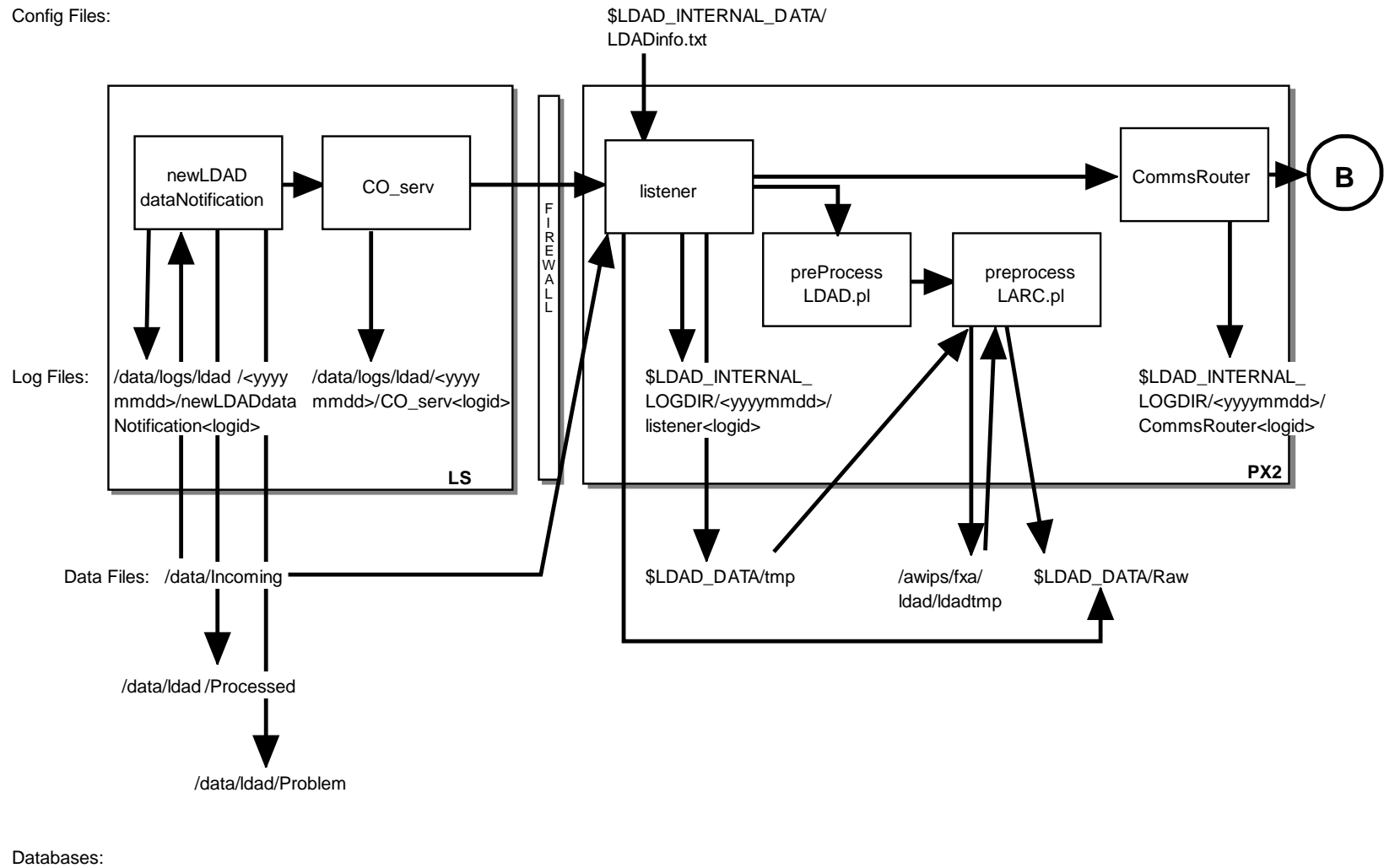

SMM 07/13/06

Exhibit 8.8-1. Decode LARC/Handar 555 Data (for LDAD) (Page 1 of 2)

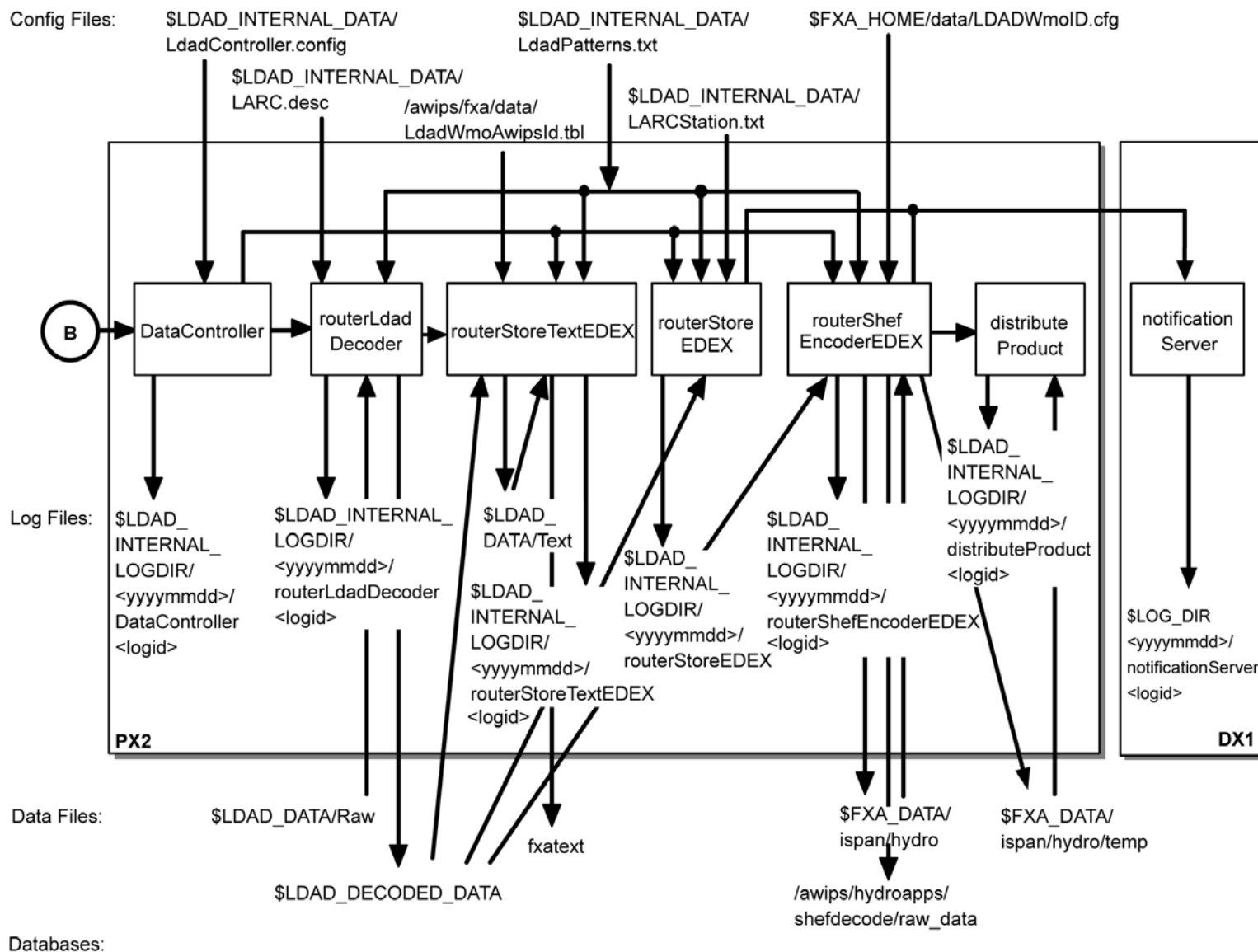

SMM 07/13/10

Exhibit 8.8-1. Decode LARC/Handar 555 Data (for LDAD) (Page 2 of 2)



- TYPE:** `tail -f <logname>`
- Displays the latest registered messages as the current log updates.

### Log Message Format

An entry at the beginning of this log looks like the following:

```
LOG-STATUS: Log file opened on host px2-tbdw at Wed Apr 12 00:00:28 2006
00:00:28.906 newLDADdataNotification.c EVENT: newLDADdataNotification process started
00:00:28.911 newLDADdataNotification.c EVENT: Reading /data/Incoming/ every 20
seconds
00:00:28.915 newLDADdataNotification.c EVENT: Processing : /data/Incoming/RAWS.dat
00:00:29.080 newLDADdataNotification.c EVENT: File more than 24hours old, removed
/data/Incoming/satxssmipw_20060412_2300.nc.gz
13:45:37.981 newLDADdataNotification.c EVENT: Processing : /data/Incoming/RAWS.dat
13:45:41.926 newLDADdataNotification.c EVENT: waitForReply SUCCESS on
/data/Incoming/RAWS.dat
13:57:38.049 newLDADdataNotification.c EVENT: Processing :
/data/Incoming/LARCPORM213555.dat
13:57:40.343 newLDADdataNotification.c EVENT: waitForReply SUCCESS on
/data/Incoming/LARCPORM213555.dat
```

The format of the log file consists of the following fields:

Time stamp	13:57:40.343
File name	newLDADdataNotification.c
Message type	EVENT:
Message string	waitForReply SUCCESS on /data/Incoming/LARCPORM213555.dat

**NOTE:** Handar 555 data files are similar to “55LARCSNMC1155303.dat.”

### 8.8.2 CO\_serv

**CO\_serv** initially sets up a (TCP/IP) socket and waits for connections. The notification received from **newLDADdataNotification** is passed across the firewall to the **listener** process on the internal side on the PX2.

#### ► To Access and Read the CO\_serv Log

The **CO\_serv** log resides on the active LS in the **\$LDAD\_EXTERNAL\_LOGDIR** directory and records messages from the **CO\_serv** process. Perform the following commands as user **ldad**:

- TYPE:** `cd $LOG_DIR/<yyyymmdd>`
- Where **<yyyymmdd>** is today’s date.

- TYPE:** `ls -ltr CO_serv*`
- Displays the current day’s **CO\_serv** logs from earliest to latest.

- TYPE:** `tail -f <logname>`

- Displays the latest registered messages as the current log updates.

### Log Message Format

An entry at the beginning of this log looks like the following:

```
LOG-STATUS: Log file opened on host ls2-rnk at Wed Apr 12 00:00:17 2006
00:00:17.076 co_serv_main.c EVENT: CO_serv process started
00:05:07.791 co_serv_main.c EVENT: CO_serv received a socket connection at: Apr12 06
00:05:07 GMT
00:05:07.801 co_serv_main.c EVENT: R message Received by CO_serv.....
00:06:36.988 co_serv_main.c EVENT: CO_serv received a socket connection at: Apr12 06
00:06:36 GMT
00:06:36.995 co_serv_main.c EVENT: R message Received by CO_serv.....
00:13:48.283 co_serv_main.c EVENT: CO_serv received a socket connection at: Apr12 06
00:13:48 GMT
00:13:48.291 co_serv_main.c EVENT: R message Received by CO_serv.....
```

The format of the log file consists of the following fields:

Time stamp	00:00:17.076
File name	co_serv_main.c
Message type	EVENT:
Message string	CO_serv process started

### 8.8.3 listener

The **listener** reads the `$FXA_DATA/LDAD/data/LDADinfo.txt` config file, sets up a socket, binds its local address so that the client (**CO\_serv**) can send to it, and waits for the connection from the Client process. When the notification is received, the **listener** retrieves the LARC/Handar 555 file from the `/data/Incoming` directory on the active LS and copies it to the `$LDAD_DATA/tmp` directory on the PX2. If the file needs no preprocessing, the **listener** moves the data file directly to the **Raw** directory. The **listener** sends a verification when finished.

The **listener** executes the `$FXA_HOME/ldad/bin/preProcessLDAD.pl` script to preprocess the LARC/Handar 555 data files, and receives the fully qualified data file, the hostname used by notification routine, the port number of the process requiring notification upon completion of preprocessing, and other necessary information about the LARC/Handar 555 data file format from **CO\_serv**. The **listener** then sends notification to the **CommsRouter LDAD\_ROUTER** process that a product has been preprocessed.

#### ► To Access and Read the listener Log

The **listener** log resides on PX2 in the directory `$LOG_DIR` and records messages from the **listener** process. Perform the following commands as user `ldad`:

**TYPE:**            `cd $LOG_DIR/<yyyymmdd>`

- Where **<yyyymmdd>** is today's date.

**TYPE:** `ls -ltr listener*`

- Displays the current day's **listener** logs from earliest to latest.

**TYPE:** `tail -f <logname>`

- Displays the latest registered messages as the current log updates.

### Log Message Format

An entry at the beginning of this log looks like the following:

```
LOG-STATUS: Log file opened on host px2-tbdw at Wed Apr 12 00:00:12 2006
00:00:12.616 listener.c EVENT: listener process started
13:57:39.347 listener.c DEBUG: do_G_Msg: rcp
ls1:/data/Incoming/LARCPORM2135555.dat
/data/fxa/LDAD/tmp/01LARCPORM2135555.dat.973000658
13:57:40.266 listener.c EVENT: do_G_Msg: rcp completed for
01LARCPORM2135555.dat.973000658
13:57:40.292 listener.c DEBUG: do_G_Msg: pInfo->preprocessorScript =
<preProcessLDAD.pl>
13:57:40.292 listener.c DEBUG: makePreprocessorCommandLine: rcp_cmd_buf =
</awips/ldad/bin/preProcessLDAD.pl
/data/fxa/LDAD/tmp/01LARCPORM2135555.dat.973000658 px 15009>
13:57:40.293 listener.c EVENT: do_G_Msg: Preprocessor Command Line =
</awips/ldad/bin/preProcessLDAD.pl
/data/fxa/LDAD/tmp/01LARCPORM2135555.dat.973000658 px 15009>
```

The format of the log consists of the following fields:

Time stamp	13:57:39.347
File name	listener.c
Message type	DEBUG:
Message string	do_G_Msg: rcp ls1:/data/Incoming/LARCPORM2135555.dat /data/fxa/LDAD/tmp/01LARCPORM2135555.dat.9730006 58

**NOTE:** Handar 555 files are similar to "55LARCSNMC1155303.dat.1029513249."

#### 8.8.4 *preProcessLDAD.pl*

The `$FXA_HOME/ldad/bin/preProcessLDAD.pl` script preprocesses **UDFCD ALERT** (**\_R5**, **\_WL**, **\_WX**), **Cdot**, **IFLOWS**, and **LARC/Handar 555** data report files for the LDAD decoder. It initializes file input and output and values to the existing variables, calls the appropriate preprocessor (**preprocessLARC.pl** for LARC/Handar 555 data), and cleans up.

### 8.8.5 *preprocessLARC.pl*

The `$FXA_HOME/ldad/bin/preprocessLARC.pl` script copies the file from the `$LDAD_DATA/tmp` directory to the `/awips/fxa/ldad/ldadtmp` directory. There, it reformats the LARC/Handar 555 data file, appends the `abstime` string to the file name, and stores the preprocessed file in the `$LDAD_DATA/Raw` directory.

### 8.8.6 *LDAD\_ROUTER*

The **LDAD\_ROUTER** (registered LDAD **CommsRouter**) is responsible for transporting data notifications from the data acquisition processes to the data controller processes. The main function of the **LDAD\_ROUTER** is message passing; it does no data processing. The router provides a known location where the data acquisition processes can send data messages.

#### ► To Access and Read the CommsRouter Log

The **CommsRouter** log resides on PX2 in a time-stamped directory under `$LOG_DIR`. Perform the following commands as user `ldad`:

```
TYPE:      cd $LOG_DIR/<yyyymmdd>
           ▪ Where <yyyymmdd> is today's date.

TYPE:      ps -wef |grep ldad
           ▪ Displays the ldad processes. Notice the PID of the
             CommsRouter process is owned by user ldad.

TYPE:      ls -rtal Comms*
           ▪ Displays the latest logs for the CommsRouter
             LDAD_ROUTER.
```

**NOTE:** The **CommsRouter** log containing the PID of the **LDAD\_ROUTER** process is the **LDAD\_ROUTER's CommsRouter** log.

```
TYPE:      tail -f <logname>
           ▪ Displays the log as it updates.
```

#### Log Message Format

An entry in the log should look like the following:

```
LOG-STATUS: Log file opened on host px2-tbdw at Tue Apr 18 00:00:09 2006
00:00:09.558 CommsReceiver.C EVENT: NCF_ENTRY CRMsg Pattern:
^[0-9.]*[^\m]([^\s]([^\a]([^\s]([^\_]([^\q]([^\c]))))))
.*\..decoded$|(.*\.[0-9]+)|(^[0-9]*\..msas_qc\..*)$|.*Text/.*\.[0-9]+
13:57:44.861 CommsReceiver.C EVENT: NCF_ENTRY DSMsg:
/data/fxa/LDAD/Text/01LARCFORM2135555.dat.973000658 1 51
```

```

13:57:45.301 CommsReceiver.C EVENT: NCF_ENTRY DSMsg:
/data/fxa/LDAD/Raw/01LARCPORM213555.dat.973000658 1 50
13:57:46.119 CommsReceiver.C EVENT: NCF_ENTRY DSMsg:
973000658.01LARCPORM213555.decoded 1 58
13:57:47.720 CommsReceiver.C EVENT: NCF_ENTRY DSMsg:
01LARCPORM213555.dat.973000658 1 31
14:02:44.429 CommsReceiver.C EVENT: NCF_ENTRY DSMsg:
/data/fxa/LDAD/Text/01LARCPORM2140053.dat.973000958 1 51
14:02:44.998 CommsReceiver.C EVENT: NCF_ENTRY DSMsg:
973000958.01LARCPORM2140053.decoded 1 58
14:02:45.037 CommsReceiver.C EVENT: NCF_ENTRY DSMsg:
/data/fxa/LDAD/Raw/01LARCPORM2140053.dat.973000958 1 50
14:02:47.450 CommsReceiver.C EVENT: NCF_ENTRY DSMsg:
01LARCPORM2140053.dat.973000958 1 31

```

The log consists of the following fields:

Time stamp	14:02:47.450
File name	CommsReceiver.C
Message type	EVENT:
Message string	NCF_ENTRY DSMsg: 01LARCPORM2140053.dat.973000958 1 31

The **LDAD\_ROUTER CommsRouter** is started automatically at system reboot time or can be started manually. The **CommsRouter** runs continuously, exiting only when killed by the restart program.

**NOTE:** Handar 555 files are similar to “55LARCSNMC1155303.dat.1029513249.”

### 8.8.7 DataController

The **DataController** is responsible for creating the decoder and storage processes (as child processes), restarting them if they exit, routing appropriate messages to them, and queuing incoming data messages until the decoder and storage processes are ready. As data messages are stored in the queue, the size of the processes grows.

The **DataController**'s main program creates a **DataRouting** manager object when it first starts up and invokes a member function to start the **routerLdadDecoder**, **routerStoreTextEDEX**, **routerStoreEDEX**, and **routerShelfEncoderEDEX** processes by reading and executing the **LdadController.config** file. The file resides on the **\$LDAD\_INTERNAL\_DATA** directory and contains the names of the processes above to start/restart, a restart flag, and end of file (**eof**) designators to alert the Data Routing Manager that there are no more processes listed in the file.

The **LDAD\_ROUTER** sends product-received notifications to the **DataController**. When the processes start up, they send messages containing their IPC addresses and process numbers to the **DataController**. The processes send the **DataController** a data request message and a ready-to-receive data message. In response, the **DataController** stores the processes' ID information and data requests, and sends a message to the requesting processes (if a message is available). The **DataController** waits to receive another ready message from the processes before sending any more data messages. The

**DataController** queues any messages received from the **LDAD\_ROUTER** until the processes send another ready message.

► **To Access and Read the DataController Log**

The **DataController** log resides on PX2 in a time-stamped directory under **\$LOG\_DIR**. Perform the following commands as user **ldad**:

**TYPE:** `cd $LOG_DIR/<yyyymmdd>`  
 ▪ Where **<yyyymmdd>** is today's date.

**TYPE:** `ls -rtal DataController*`  
 ▪ Displays the latest logs for the **DataControllers**.

**TYPE:** `tail -f <logname>`  
 ▪ Displays the log as it updates with the latest messages.

### Log Message Format

An entry in the log should look like the following:

```
01:30:23.120 CommsReceiver.C EVENT: NCF_ENTRY CDMsg:
/data/fxa/LDAD/Raw/alert_r5.dat.1335231022 1 42

01:30:23.121 CommsReceiver.C EVENT: NCF_ENTRY CDMsg:
/data/fxa/LDAD/Raw/RAWS.dat.1335231022 1 38

01:30:23.134 CommsReceiver.C EVENT: NCF_ENTRY CDMsg: RAWS.dat.1335231022 1 19

01:30:23.156 CommsReceiver.C EVENT: NCF_ENTRY CDMsg: 1335231022.alert_r5.decoded 1
50

01:30:23.164 CommsReceiver.C EVENT: NCF_ENTRY CDMsg: 1335231022.RAWS.decoded 1 46

01:30:25.137 CommsReceiver.C EVENT: NCF_ENTRY CDMsg: alert_r5.dat.1335231022 1 23

01:35:22.636 CommsReceiver.C EVENT: NCF_ENTRY CDMsg:
/data/fxa/LDAD/Text/alert_r5.dat.1335231322 1 43

01:35:22.657 CommsReceiver.C EVENT: NCF_ENTRY CDMsg:
/data/fxa/LDAD/Raw/alert_r5.dat.1335231322 1 42

01:35:22.660 CommsReceiver.C EVENT: NCF_ENTRY CDMsg: 1335231322.alert_r5.decoded 1
50

01:35:24.675 CommsReceiver.C EVENT: NCF_ENTRY CDMsg: alert_r5.dat.1335231322 1 23
```

The log file consists of the following fields:

Time stamp	01:30:23.120
File name	CommsReceiver.C
Message type	EVENT:
Message string	NCF_ENTRY CDMsg: /data/fxa/LDAD/Raw/alert_r5.dat.1335231022 1 42

**NOTE:** Handar 555 files are similar to “55LARCSNMC1155303.dat.1029513249.

### 8.8.8 *routerLdadDecoder*

The **routerLdadDecoder** process is spawned by the **DataController** as specified in the **LdadController.config** file. The **routerLdadDecoder** process sends a data request to the **DataController** for the LARC/Handar 555 products it wishes to receive by specifying product header patterns of interest. On receipt of a notification from the **DataController** that a product of interest has arrived, the **routerLdadDecoder** reads the directory containing the raw files, **\$LDAD\_DATA/Raw**.

The **routerLdadDecoder** process reads each file and stores it via serialized data files to the **\$LDAD\_DECODED\_DATA** directory. The serialized file name is sent back through the **LDAD\_ROUTER** to notify registered LDAD storage processes of the arrival of each LDAD decoded product.

#### ► **To Access and Read the routerLdadDecoder Log**

The **routerLdadDecoder** log resides on PX2 in a time-stamped directory under **\$LOG\_DIR**. Perform the following commands as user **ldad**:

**TYPE:** `cd $LOG_DIR/<yyyymmdd>`  
 ▪ Where **<yyyymmdd>** is today’s date.

**TYPE:** `ls -rtal routerLdadDecoder*`  
 ▪ Displays the latest **routerLdadDecoder** logs.

**TYPE:** `tail -f <logname>`  
 ▪ Displays the log as it updates with the latest messages.

#### **Log Message Format**

An entry in the log should look like the following:

```
20:15:42.973 LdadRoutines.C EVENT: Processing [1/1] = RAWS.dat.1342037741
20:15:42.978 LdadRoutines.C EVENT: LdadRoutines::pingLdadRouter(),
'$LDAD_DECODED_DATA/ 1342037741.RAWS.decoded', sent to LDAD_ROUTER

20:15:43.156 LdadRoutines.C EVENT: Processing [1/1] = alert_r5.dat.1342037741
20:15:43.160 LdadRoutines.C EVENT: LdadRoutines::pingLdadRouter(),
'$LDAD_DECODED_DATA/ 1342037741.alert_r5.decoded', sent to LDAD_ROUTER

20:16:02.252 LdadRoutines.C EVENT: Processing [1/1] =
1342036800.16.msas_qc.RAWS
20:16:02.256 LdadRoutines.C EVENT: LdadRoutines::pingLdadRouter(),
'$LDAD_DECODED_DATA/ RAWS.1342036800.16.msas_qc.decoded', sent to LDAD_ROUTER
```

The log file consists of the following fields:

```

Time stamp      20:15:42.973
File name       LdadRoutines.C
Message type    EVENT:
Message string   Processing [1/1] = RAWS.dat.1342037741

```

**NOTE:** Handar 555 files look similar to “55LARCSNMC1155303.dat.1029513249.”

### 8.8.9 *routerStoreTextEDEX*

The **routerStoreTextEDEX** process is spawned by the **DataController** as specified in the **LdadController.config** file. The **routerStoreTextEDEX** process sends a data request to the **DataController** for the text products it wishes to receive by specifying product header patterns of interest. Upon receipt of a notification from the **DataController** that a product of interest has arrived (based on the pattern in **/awips/fxa/ldad/data/LdadPatterns.txt** file), the **routerStoreTextEDEX** reads the directory containing the decoded files, **\$LDAD\_DECODED\_DATA**.

The **routerStoreTextEDEX** process reads each file and stores it temporarily in the **\$LDAD\_DATA/Text** directory. The **routerStoreTextEDEX** process reads **/awips/fxa/data/LdadWmoAwipsId.tbl** file to determine what WMO ID is associated with the product and using that ID to store the product into the **fxatext** database.

#### ► **To Access and Read the routerStoreTextEDEX Log**

The **routerStoreTextEDEX** log resides on PX2 in a time-stamped directory under **\$LOG\_DIR**. Perform the following commands as user **ldad**:

```

TYPE:      cd $LOG_DIR/<yyyymmdd>
               ■ Where <yyyymmdd> is today’s date.

TYPE:      ls -rtal routerStoreTextEDEX*
               ■ Displays the latest routerStoreTextEDEX logs.

TYPE:      tail -f <logname>
               ■ Displays the log as it updates with the latest messages.

```

#### **Log Message Format**

An entry in the log should look like the following:

```

01:35:22.650 LdadStoreText.C EVENT: LdadStoreText::getLdadProductType(), found:
<alert_r5> in </data/fxa/LDAD/Text/alert_r5.dat.1226295637>
01:35:22.650 LdadStoreText.C EVENT: LdadStoreText::getLdadProductType(), found:
<alert_r5> in </data/fxa/LDAD/Text/alert_r5.dat.1228995927>
01:35:22.650 LdadStoreText.C EVENT: LdadStoreText::getLdadProductType(), found:
<alert_r5> in /data/fxa/LDAD/Text/alert_r5.dat.1229018126>
01:35:22.650 LdadStoreText.C EVENT: LdadStoreText::getLdadProductType(), found:
<alert_r5> in </data/fxa/LDAD/Text/alert_r5.dat.1229146539>

```



```

01:35:22.651 LdadStoreText.C EVENT: LdadStoreText::getLdadProductType(), found:
<alert_r5> in </data/fxa/LDAD/Text/alert_r5.dat.1229147139>
01:35:22.651 LdadStoreText.C EVENT: LdadStoreText::getLdadProductType(), found:
<alert_r5> in </data/fxa/LDAD/Text/alert_r5.dat.1229426723>
01:35:22.651 LdadStoreText.C EVENT: LdadStoreText::getLdadProductType(), found:
<alert_r5> in </data/fxa/LDAD/Text/alert_r5.dat.1229427623>
01:35:22.651 LdadStoreText.C EVENT: LdadStoreText::getLdadProductType(), found:
<alert_r5> in </data/fxa/LDAD/Text/alert_r5.dat.1229428223>
01:35:22.652 LdadStoreText.C EVENT: LdadStoreText::getLdadProductType(), found:
<alert_r5> in </data/fxa/LDAD/Text/alert_r5.dat.1335231322>
01:35:22.798 routerStoreTextEDEX.C EVENT: NCF_STORE STOLCOR5

```

### 8.8.10 routerStoreEDEX

The **routerStoreEDEX** process is spawned by the **DataController** as specified in the **LdadController.config** file. The **routerStoreEDEX** process sends a data request to the **DataController** for serialized decoded LARC/Handar 555 files in netCDF format. When notified by the **DataController** that a product of interest has arrived, **routerStoreEDEX** reads the directory containing the files, **\$LDAD\_DECODED\_DATA**. The **routerStoreEDEX** process stores the files in the **/data\_store/ldad** directory in **XML format** and sends a notification to the **EDEX**.

#### ► To Access and Read the routerStoreEDEX Log

The **routerStoreEDEX** log resides on PX2 in a time-stamped directory under **\$LOG\_DIR**. Perform the following commands as user **ldad**:

```

TYPE:      cd $LOG_DIR/<yyyymmdd>
               ■ Where <yyyymmdd> is today's date.

TYPE:      ls -rtal routerStoreEDEX*
               ■ Displays the latest logs for the process. If more than one log
                 exists, choose the log for the current routerStoreEDEX
                 process by looking for the PID in the logname.

TYPE:      tail -f <logname>
               ■ Displays the log as it updates with the latest messages.

```

#### Log Message Format

An entry in the log should look like the following:

```

LOG-STATUS: Log file opened on host px2-tbw3 at Tue Jul 13 00:30:06 2010

00:15:43.050 routerStoreEDEX.C EVENT: NCF_ENTRY
/data/fxa/LDAD/decoded/1341965741.alert_r5.decoded
00:15:43.074 routerStoreEDEX.C EVENT: NCF_STOREd to
/data_store/ldad/LDAD.hydro.1341965741.alert_r5.decoded.xml
00:15:43.075 routerStoreEDEX.C EVENT: 1341965741.alert_r5.decoded processing
completed

```

```

00:16:02.927 routerStoreEDEX.C EVENT: NCF_ENTRY
/data/fxa/LDAD/decoded/RAWS.1341964800.16.msas_qc.decoded
00:16:02.930 routerStoreEDEX.C PROBLEM: EDEX file endpoint for type is not
defined
00:16:02.930 routerStoreEDEX.C EVENT: RAWS.1341964800.16.msas_qc.decoded
processing completed
00:20:42.343 routerStoreEDEX.C EVENT: NCF_ENTRY
/data/fxa/LDAD/decoded/1341966041.alert_r5.decoded
00:20:43.013 routerStoreEDEX.C EVENT: NCF_STORED to
/data_store/ldad/LDAD.hydro.1341966041.alert_r5.decoded.xml

```

The log file consists of the following fields:

```

Time stamp          00:15:43.050
File name           routerStoreEDEX.C
Message type        EVENT:
Message String:    /data/fxa/LDAD/decoded/1341965741.alert_r5.decoded

```

**NOTE:** Handar 555 files are similar to “55LARCSNMC1155303.decoded.1029513249.”

### 8.8.11 routerShefEncoderEDEX

The **routerShefEncoderEDEX** process is spawned by the **DataController** as specified in the **LdadController.config** file. The **routerShefEncoderEDEX** process sends a data request to the **DataController** for serialized decoded files. On receipt of a notification from the **DataController** that a product of interest has arrived, the **routerShefEncoderEDEX** reads the directory containing the files, **\$LDAD\_DECODED\_DATA**. The files there are SHEF-encoded and moved to the **/data\_store/ldad** directory. The **routerShefEncoderEDEX** process sends a notification to the **EDEX**. Once the SHEF-encoded data file is stored in the **/data\_store/ldad** directory, the **routerShefEncoderEDEX** saves a copy of the file in the **/tmp** directory and calls **distributeProduct** process to send the file to the NCF over the WAN.

#### ► To Access and Read the routerShefEncoderEDEX Log

The **routerShefEncoderEDEX** log resides on PX2 in a time-stamped directory under **\$LOG\_DIR**. Perform the following commands as user **ldad**:

```

TYPE:      cd $LOG_DIR/<yyyymmdd>
               ■ Where <yyyymmdd> is today’s date.

TYPE:      ls -rtal routerShefEncoder*
               ■ Displays the latest routerShefEncoderEDEX logs.

TYPE:      tail -f <logname>
               ■ Displays the log as it is updated with the latest messages.

```

#### Log Message Format

An entry in the log should look like the following:

```

20:25:42.703 routerShefEncoderEDEX.C EVENT: NCF_STOREd to
/data_store/ldad/SXUS44 KWOHshef.1342038342

20:25:42.704 checkWmoHeader.C EVENT: checkWmoHeader()

20:25:42.704 checkWmoHeader.C EVENT: checkWmoHeader() : data
contains a WMO header.

20:25:42.704 SHEF_format.C EVENT: SHEF_format::sendToProductWan ->
data contains a WMO header.

Creating a dummy file (zero bytes).

20:25:42.733 SHEF_format.C EVENT: SHEF_format::sendToProductWan ->
system(distributeProduct -a DEFAULTNCF -e /tmp/shefwanvC9WSQ
KBOXRRZBOX /tmp/shefwanvC9WSQ_msg);

20:25:42.733 SHEF_format.C EVENT: shef data has sent to WAN
successfully!

```

### 8.8.12 *distributeProduct*

The **distributeProduct** process creates a product message and submits it for distribution across the AWIPS WAN to the addressed sites. The **distributeProduct** process first prepares the product by creating the WAN communications header and prepending the header to a temporary copy of the product.

#### ► **To Access and Read the distributeProduct Log**

The **distributeProduct** log resides on PX2 in a time-stamped directory under **\$LOG\_DIR**. Perform the following commands as user **ldad**:

```

TYPE:      cd $LOG_DIR/<yyyymmdd>
               ■      Where <yyyymmdd> is today's date.

TYPE:      ps -ef |grep ldad
               ■      Displays the ldad processes.

TYPE:      ls -ltr distributeProduct*
               ■      Displays the latest logs for the distributeProduct process.

TYPE:      tail -f <logname>
               ■      Displays the log as it updates with the latest messages.

```

#### **Log Message Format**

An entry in the log file should look like the following:

```

LOG-STATUS: Log file opened on host px2-tbdw at Wed Apr 12 19:30:59 2006
19:30:59.690 MHSProduct.C PROBLEM: Product
(/data/fxa/ispan/hydro/temp/A_format.973020657_msg) is empty.
19:30:59.853 MHSProduct.C EVENT: Sending attachments
(/data/fxa/ispan/hydro/temp/A_format.973020657)

```

only. Attachments are assumed to contain correct communications header.  
 19:31:02.504 MHSProduct.C EVENT: Product request (KSTORRZLDA) was successfully submitted to the MHS request server for distribution.

```

Message Attributes:
  Request ID: TBDW-25380
  To: DEFAULTINCF
  Priority: 0
  Type: Routine
  Subject:
  Handling Action: 0
  
```

19:31:02.518 MHSProduct.C EVENT: TBDW-25380

~

The log file consists of the following fields:

```

Time stamp      19:31:02.504
File name      MHSProduct.C
Message type    EVENT:
Message string  Product request (KSTORRZLDA) was successfully
                submitted to the MHS request server for
                distribution.
  
```

```

Message Attributes:
Request ID: TBDW-25380
To: DEFAULTINCF
Priority: 0
Type: Routine
Subject:
Handling Action: 0
  
```

## 8.9 *Acquire Campbell Data*

Data collection from Campbell gauges is carried out by automating a normally interactive session using the **cu** communication protocol. There is a Server program (**CO\_serv**) and a Client program (**tell\_co**). The Server program is always running, waiting for, and processing requests to collect data from a particular gauge from the Client program. The Client program can be invoked from a shell script, as a cron job, or directly from a command prompt. A feature of the Client program is that it retrieves all necessary information regarding collection and storage of data from system tables in the AWIPS database. The Client and Server programs use sockets to communicate across a TCP/IP LAN. Data from a gauge are SHEF-encoded prior to storage on AWIPS. The **.dat** is moved into the Raw directory, while the SHEF file is stored into the text database, archived, and sent to the Office of Hydrology's database during preprocessing. The **.dat** file is forwarded to the **ldadDecoder** process to further decode the Campbell data for creation of the netCDF and SHEF-encoded files.

### Processes

```

LS    callSite.ksh
LS    process_expect
LS    CO_serv
LS    campbell
PX2   listener
PX2   tell_co
PX2   ldadServer
  
```

LX ldadScheduler  
DX1 notificationServer

### Configuration Files (all in /data/fxa/LDAD/data)

LDADinfo.txt	(for <b>listener</b> )
CAMPBELLStation.txt	(for <b>tell_co, ldadScheduler</b> )
userDescriptions	(for <b>ldadScheduler</b> )
gaugeSessList	(for <b>ldadScheduler</b> )
userSessList	(for <b>ldadScheduler</b> )
usrpro	(for <b>ldadScheduler</b> )
gageinfo	(for <b>ldadScheduler</b> )
gageinfoCampbell.txt	(for <b>ldadScheduler</b> )
gaugeDescriptions	(for <b>ldadScheduler</b> )
SHEFcodes.cfg	(for <b>campbell</b> )

### LDADinfo.txt

The file should contain the following entry:

```
CAMPBELL | CAMPBELL | 89 | 90 | CVS_TYPE | hydro |
                preprocessCAMPBELL.pl |
```

Once the file is installed, this line should not be modified.

### CAMPBELLStation.txt

This file must be updated whenever a gauge is added to or dropped from the current Campbell datalogger list. To add a new Campbell gauge, find out the following gauge information to create a new entry in the station table format (\* indicates a mandatory field):

- **Provider ID:** Data provider station or gauge ID (\*)
- **AFOS(HB5) ID:** The AFOS or Handbook 5 ID (NWS assigned)
- **Station Name:** Text name of station
- **Elevation:** Station elevation (m) (\*)
- **Latitude:** Station Latitude (decimal degrees, north positive) (\*)
- **Longitude:** Station Longitude (decimal degrees, east positive) (\*)
- **Local Time Zone:** Reporting time zone (e.g., UTC, PST8PDT) (\*) (see Note)
- **Location Description:** Station location/address (Text)
- **Station Type:** Type of station (e.g., tower, surface, floating platform, etc.)
- **Number of Instruments:** The number of reporting instruments for the station

- **Number of Reporting Levels:** Number of data reporting levels. Level information should be provided in the instrument table
- **Maintenance/Calibration Schedule:** Frequency of maintenance/calibration
- **Site Description:** A text description of the site surroundings.

The entries are sorted alphabetically by the gauge ID.

This file must be identical on the PX2 and on LS1!

**NOTE:** The local time zone for Campbell gauges is always GMT because the Campbell Decoder already converts the observation times into GMT times.

### userDescriptions

This file is used by the **ldadScheduler** process to get the descriptions of users. When read in, blank lines and lines beginning with # are skipped. All other lines should have the following format:

```
<user ID>|<user description>
```

A blank user description is denoted by having the line end immediately following the | character (a vertical bar or “pipe”).

This file should not be modified manually. It should only be written to by the **ldadScheduler** (specifically, the **LdadSchedulerServer.C** routine).

### usrpro

The user file (**usrpro**) is made up of zero to n lines, each line holding the following information (note that the lines are so long that they are wrapped in the interests of readability). Columns containing “??” are not used at this time.

```
<ID>|<protocol>|<IP address>|<phone number>|<login>|<password (encrypted)>|??|<file to receive>|<file to send>|??|??|<data collection session file>|<data dissemination session file>|<local directory>|<remote directory>|??... (columns 16 through 36 have unknown meanings)...|<IP address>|
```

- The <protocol> is either “F” for FTP, “X” for Xmodem, “Y” for Ymodem, “Z” for Zmodem, or “K” for Kermit.
- The <IP address> designates the host to FTP to, if the protocol is “F,” or the terminal server otherwise. <IP address> appears in two places in the above column listing: columns 3 and 37. In reality, only one of the two columns is used. For the FTP protocol, only column 3 has the address in it, and column 37 is left blank. If any other protocol is being used, column 37 has the address in it, and column 3 is left blank.
- The <phone number> field is unused if the protocol is “F.”
- The <file to receive> and <file to send> fields are mutually exclusive. Only one may be specified, and which one is specified indicates also whether this user is a collection

user (if <file to receive> is given) or a dissemination user (if <file to send> is given). All other columns are tracked when read in; when written out, the same values are placed in them as were originally found.

### gageinfo

The **gageinfo** file contains a list of Handbook 5 and Campbell gauges. It is updated periodically as Campbell gauges are added and removed with the **ldadScheduler**. Whenever a gauge is added or dropped from the current list, it should be updated here and in the following files:

```
$LDAD_DATA/data/gageinfoCampbell.txt
$LDAD_DATA/data/CAMPBELLStation.txt
$LDAD_DATA/data/gaugeDescriptions
```

The following fields must be present for each gauge (see Note):

- **Gauge ID:** A five-character instrument ID.
- **Protocol Type:** C for data collection, D for dissemination.
- **Phone#:** The dial-out phone number can be in any format. However, if the gauge has the voice message first, several pauses are included in the phone number. Depending on the length of the voice message, add more pauses if the one listed here is not enough. The pause is entered by comma (,) and is ended with a \*9. If a phone number contains a pause extension, make sure the phone number is enclosed by single quotes('). Example: '1-605.886.2473,,,,\*9'
- **Session File:** Use CAMPBELL\_coll\_sess exactly.
- **SHEF File:** 1 = Yes; 0 = No.
- **Storage Type:** S.
- **Baud Rate:** Use 9600 for Campbell gauges.
- **Terminal Server (tty):** Use 8n1out for Campbell gauges.

The fields are separated by vertical bars (|); empty fields are for future use. A number nine (9) in front the phone number allows the user to dial out. An example follows:

```
BBCW3|C| |917158843133| | | |CAMPBELL_coll_sess|1|S| | |9600|e|
|8n1out|
```

**NOTE:** The **rcvprog** field indicates the receiving program (e.g., FTP) for data collection. This field is used as the custom gauge ID if the gauge is owned by the NWS.

### gageinfoCampbell.txt

This file should be updated along with the **gageinfo** file when adding/dropping Campbell gauge(s). There are at least four fields for each Campbell gauge to be entered when adding a gauge; the fields are as follows:

- **Gauge ID:** A five-character instrument ID (i.e., BRCW3).
- **Local Time Zone:** Time zone where the Campbell gauges are located, (e.g., PST, CDT, GMT, etc.).
- **Data Array ID for Storage Area 1:** Four digit array ID.
- **Observation Field Skip Bit Map for Array ID Number One:** This is an eight-bit field used to mark the observation fields to be ignored.
- **Bit Map for Observation Data Fields in PE Codes for Storage Area 1 in Hexadecimal Format:** This is a 32-bit code (see Note). The leftmost byte is designed to ignore collected data fields and the other three are used to map the type of data collected relevant to the PE codes listed in the **SHEFcodes.cfg** file.
- **Data Array ID for Storage Area 2:** Four digits array ID for gauge collection data and storing in Storage Area 2.
- **Bit Map for Collecting Data Fields in PE Codes for Storage Area 2:** Same format as Storage Area 1 if the gauge collects data and stores it in Storage Area 2.

**NOTE:** Current design can accommodate a maximum of eight data fields only for a Campbell gauge and a maximum of 32 PE codes collected by all Campbell gauges. If an individual gauge collects more than eight different data fields or if the total number of the PE codes collected by the Campbell gauges exceeds 32, these fields will have to be expanded to incorporate the changes.

### gaugeDescriptions

The file is used to get the site descriptions and should be updated using the **ldadScheduler** when a new Campbell gauge is added. Each entry (line) should have the following format:

```
<gauge ID> | <site description>
```

For example, an entry for the BARW3 would be as follows:

```
BARW3 | Barron, WI
```

The file is sorted by state abbreviations. However, it is displayed based on the alphabetical order of the gauge IDs.

### SHEFcodes.cfg

The file is designed specifically for Campbell gauges to enable creation of SHEF-encoded files (**.shf**). It contains the PE codes currently collected by Campbell CR10X gauges. The elements in the file are presented in alphabetical order and should be updated every time a new PE code is added to the file. When this file is modified, the LDAD system has to be shut down and restarted again.



The codes are used in constructing the 3-byte PE code bit map in the **gageinfoCampbell.txt** file. It is also used as the base for creating/updating of the **\$LDAD\_DATA/data/CAMPBELL.desc** file.

Refer to Exhibit 8.9-1 for the Acquire Campbell Data data flow diagram.

### 8.9.1 *User Interface: ldadScheduler*

The **ldadScheduler**'s function is to perform certain data acquisition/dissemination events on an automatic basis at specified time intervals (in the background). Access to the Scheduler's functions is via a GUI invoked by selecting **Collection/Dissemination...** from the **Surface** pull-down menu.

The **ldadScheduler** provides a window by which the user may create, view, and manipulate scheduled LDAD requests. It allows the user to create a new request and add it to the request list. The request is activated when submitted to the **ldadServer**, which uses **sendLDADnotification.pl** to create the request. If it is a one-time request (OTR), the user can monitor its progress via a status dialog.

The **ldadScheduler** registers with the **ldadServer** providing a callback routine for update notifications. The session file contents get registered first, and the status messages and ID updates so that when registering with **ldadServer**, the ID lists sent by **ldadServer** will be caught and kept. It also registers with the File Access Controller (FAC) for notifications of changes to the existing requests file, and creates a FAC lock for the file to be used for locking it for "reads" and "writes." The existing requests get read so as to fill the tree view with the requests that have been created.

### 8.9.2 *ldadServer*

The **ldadServer** allows multiple clients to connect to it and submit requests with intervals and durations that are honored according to their intervals until they expire.

New client initialization is performed by sending the gauge and user lists to the newly registered client. The **ldadServer** process creates a new message with the current active list and broadcasts it to all registered clients.

To honor the specified request, the **ldadServer** creates the command to be executed.

The **ldadServer** process receives LDAD messages from clients; messages to create and delete gauges and users; and messages requesting the contents of a session file, or specifying a session file's contents.

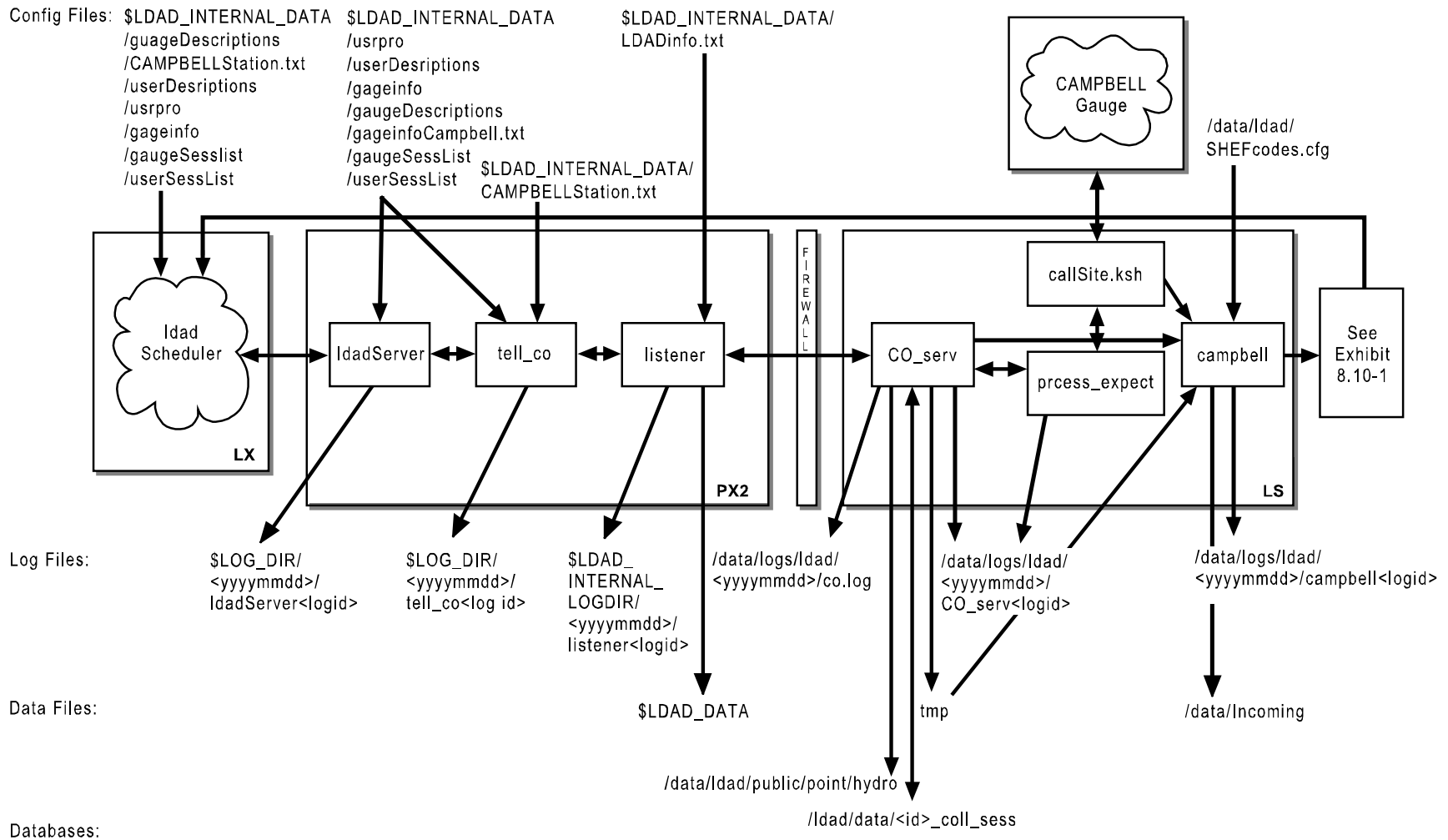

SMM\_033111

**Exhibit 8.9-1. Acquire Campbell Data (for LDAD)**

► **To Access and Read the ldadServer Log**

The **ldadServer** log resides on the PX2 in the **\$LOG\_DIR** directory and records messages from the **ldadServer** process. Perform the following commands as user **ldad**:

- TYPE:**            `cd $LOG_DIR/<yyyymmdd>`
- Where **<yyyymmdd>** is today's date.
- TYPE:**            `ls -ltr ldadServer*`
- Displays the current day's **ldadServer** logs from earliest to latest.
- TYPE:**            `tail -f <logname>`
- Displays the latest registered messages as the log updates.

### Log Message Format

An entry at the beginning of the log looks like the following:

```
LOG-STATUS: Log file opened on host px2-tbdw at Wed Apr 12 20:11:03 2006
16:11:37.334 LdadSchedulerServer.C PROBLEM: The gauge "BBCW3" specified in
gageinfoCampbell.txt was not found in gageinfo.txt. This gauge will not be
used.
16:11:37.345 LdadSchedulerServer.C PROBLEM: The gauge "BBCW3" specified in
gageinfoCampbell.txt was not found in gageinfo.txt. This gauge will not be
used.
20:11:03.470 Connection.C EVENT: WARNING: this process wants to use target
LDAD_SCHEDULE_SERVER which is assigned to run on px-tbdw but the current host
is px2-tbdw
20:11:03.492 LdadSchedulerServer.C PROBLEM: The gauge "BBCW3" specified in
gageinfoCampbell.txt was not found in gageinfo.txt. This gauge will not be
used.
20:12:12.926 SignalClient.C EVENT: Signal 15 (Terminate) received for clean
shutdown
```

The format of the log consists of the following fields:

Time stamp	16:11:37.345
File name	LdadSchedulerServer.C
Message type	PROBLEM:
Message string	The gauge "BBCW3" specified in gageinfoCampbell.txt was not found in gageinfo.txt. This gauge will not be used.

### 8.9.3 *tell\_co*

The **ldadServer** process invokes the client program **tell\_co**, the main controller process providing the CAMPBELL ID. The **tell\_co** function retrieves all information regarding a specified gauge from the LDAD configuration files. This includes all communication details, the name of the session file to use, as well as the location to store the data on

AWIPS and whether SHEF encoding is required. It formats an interprocess message containing the aforementioned information, opens a socket to the **listener**, and sends a get CAMPBELL Message “IPC” message to the **listener**.

► **To Access and Read the tell\_co Log**

The **tell\_co** log resides on the PX2 in the **\$LOG\_DIR** directory and records messages from the **tell\_co** process. Perform the following commands as user ldad:

**TYPE:**        cd \$LOG\_DIR/<yyyymmdd>  
                   ▪        Where <yyyymmdd> is today’s date.

**TYPE:**        ls -ltr tell\_co\*  
                   ▪        Displays the current day’s **tell\_co** logs from earliest to latest.

**TYPE:**        tail -f <logname>  
                   ▪        Displays the latest registered messages as the log updates.

**Log Message Format**

An entry at the beginning of the log looks like the following:

```
LOG-STATUS: Log file opened on host px2-tbdw at Wed Apr 12 19:45:55 2006
19:45:55.368 doAlivenessTest.c EVENT: waitForReply INTERNAL SUCCESS!!!!...
19:45:56.253 doAlivenessTest.c EVENT: waitForReply EXTERNAL SUCCESS!!!!...
19:45:57.205 tell_co.c EVENT: TELL_CO waitForReply SUCCESS!!!!...
```

The format of the log consists of the following fields:

Time stamp	19:45:57.205
File name	tell_co.c
Message type	EVENT:
Message string	TELL_CO waitForReply SUCCESS!!!!...

**8.9.4 listener**

The **listener** sets up a socket connection, binds to a local address so that the Client (**CO\_serv**) or **tell\_co** can send to it, and waits for the connection. Upon receipt of a data collection request from **tell\_co**, the **listener** forwards information received to the **CO\_serv** process. If any errors were encountered during the data logging, an error message is formulated and passed to the Scheduler for display. In addition, Campbell gauge dialing status information is sent by the **listener** and displayed by the Scheduler.

► **To Access and Read the listener Log**

The **listener** log resides on PX2 in the **\$LDAD\_INTERNAL\_LOGDIR** directory and records messages from the **listener** process. Perform the following commands as user **ldad**:

- TYPE:**        `cd $LOG_DIR/<yyyymmdd>`
- Where **<yyyymmdd>** is today's date
- TYPE:**        `ls -ltr listener*`
- Displays the current day's **listener** logs from earliest to latest
- TYPE:**        `tail -f <logname>`
- Displays the latest registered messages as the log updates

**Log Message Format**

An entry at the beginning of this log looks like the following:

```
LOG-STATUS: Log file opened on host px2-tbdw at Wed Apr 12 00:00:12 2006
00:00:12.616 listener.c EVENT: listener process started
18:18:27.652 listener.c EVENT: child listener: rcp completed for
CAMPBELL_coll_sess
18:18:27.755 listener.c EVENT: rcp_cmd_buf=
/awips/ldad/bin/sendLDADnotification.pl V NOTHING px2 1780
18:18:27.807 listener.c PROBLEM: child listener: failed to
sendLDADNotification for CAMPBELL_coll_sess
```

The format of the log file consists of the following fields:

Time stamp	18:18:27.652
File name	listener.c
Message type	EVENT:
Message string	child listener: rcp completed for CAMPBELL_coll_sess

### 8.9.5 *CO\_serv*

The Server program (**CO\_serv**) opens up a socket and continually listens for connections from the Client program. When one arrives, a child process is spawned that reads the interprocess message, extracts the name of the “session” file (session file located in **/ldad/data/<id\_coll\_sess>** ) for the gauge in question (Campbell), and parses this session file to create two temporary files: a response file and a script file. **CO\_serv** first calculates the starting point of the data to be retrieved and how many data intervals to retrieve from the working configuration file. Using the **process\_expect**, **CO\_serv** retrieves the data from the Campbell gauge and stores it in a temporary file. The data are sent to the **campbell** decoder process for decoding. If any errors were encountered during the data logging, the error messages are formulated and sent to the user's workstation for display.

► **To Access and Read the CO\_serv Log**

The **CO\_serv** log resides on the active LS in the directory **\$LOG\_DIR** and records messages from the **CO\_serv** process. Perform the following commands as user **ldad**:

- TYPE:** `cd $LOG_DIR/<yyyymmdd>`
- Where **<yyyymmdd>** is today's date.
- TYPE:** `ls -ltr CO_serv*`
- Displays the current day's **CO\_serv** logs from earliest to latest.
- TYPE:** `tail -f <logname>`
- Displays the latest registered messages as the log updates.

### Log Message Format

An entry at the beginning of this log looks like the following:

```
LOG-STATUS: Log file opened on host ls1-rnk at Wed Apr 12 00:00:17
2006
00:00:17.076 co_serv_main.c EVENT: CO_serv process started
00:05:07.791 co_serv_main.c EVENT: CO_serv received a socket
connection at: May12 04 00:05:07 GMT
00:05:07.801 co_serv_main.c EVENT: R message Received by
CO_serv.....
00:06:36.988 co_serv_main.c EVENT: CO_serv received a socket
connection at: May12 04 00:06:36 GMT
00:06:36.995 co_serv_main.c EVENT: R message Received by
CO_serv.....
00:13:48.283 co_serv_main.c EVENT: CO_serv received a socket
connection at: May12 04 00:13:48 GMT
00:13:48.291 co_serv_main.c EVENT: R message Received by
CO_serv.....
```

The format of the log file consists of the following fields:

Time stamp	00:13:48.283
File name	co_serv_main.c
Message type	EVENT:
Message string	CO_serv received a socket connection at: Apr12 06 00:13:48 GMT

### 8.9.6 *process\_expect*

The **process\_expect** executable processes the request for a data transfer. It parses the receive or send session file and invokes **do\_expect** to carry out the transfer by using the script file created by the **parse\_session\_file** function as input. It stores the data in the appropriate place and deletes any temporary files used during this session.

► **To Access and Read the CO\_serv Log**

**process\_expect** writes its messages into the **CO\_serv** log. The log resides on the active LS in the directory **\$LOG\_DIR**. Perform the following commands as user **ldad**:

- TYPE:**        `cd $LOG_DIR/<yyyymmdd>`
- Where **<yyyymmdd>** is today's date.
- TYPE:**        `ls -ltr CO_serv*`
- Displays current day's logs from earliest to latest.
- TYPE:**        `tail -f <logname>`
- Displays the latest registered messages as the log updates.

### Log Message Format

An entry at the beginning of this log looks like the following:

```
process_expect.c EVENT: portLockFile==> /ldad/bin/8e1out
20:24:55.303 process_expect.c EVENT: Successfully read data from BBCW3
20:33:33.492 process_expect.c PROBLEM: process_expect: expect session timed
out
process_expect.c EVENT: portLockFile==> /ldad/bin/8n1out
```

The format of the log file consists of the following fields:

Time stamp	20:24:55.303
File name	process_expect.c
Message type	EVENT:
Message string	Successfully read data from BBCW3

#### 8.9.7 *callSite.ksh*

The **callSite.ksh** interrogates the datalogger and passes the raw data received from the gauge to the **campbell** decoder for the creation of the CSV and SHEF files.

#### 8.9.8 *campbell decoder*

The **campbell** decoder decodes the data and creates a CVS (**.dat**) format file and a SHEF format file using the **SHEFcodes.cfg** configuration file. The files are put in the **/data/Incoming** directory. The number of data intervals collected and the time stamp for the last data interval are written back into the working configuration file to be used by the next data retrieval.

► **To Access and Read the campbellDecoder Log**

The **campbell** decoder log resides on the active LS in the directory **\$LOG\_DIR** and records messages from the **campbell** decoder process. Perform the following commands as user ldad:

**TYPE:**           cd \$LOG\_DIR/<yyyymmdd>  
                   ▪       Where <yyyymmdd> is today's date.

**TYPE:**           ls -ltr campbell\*  
                   ▪       Displays the current day's logs from earliest to latest.

**TYPE:**           tail -f <logname>  
                   ▪       Displays the latest registered messages as the log updates.

### Log Message Format

An entry at the beginning of this log looks like the following:

```
LOG-STATUS: Log file opened on host ls1-tbdw at Wed Apr 12 14:37:11 2006
14:37:11.682 Campbell.C EVENT: Start decoding Campbell data for AEFW3
14:37:12.018 Campbell.C EVENT: Successfully decoded Campbell data for AEFW3.
~
```

The format of the log file consists of the following fields:

```
Time stamp           14:37:12.018
File name            Campbell.C
Message type         EVENT:
Message string       Successfully decoded Campbell data for AEFW3.
```

## 8.10 Decode Campbell Data

The **newLDADdataNotification** script checks the LDAD products directory for Campbell files. When a file is available, **newLDADdataNotification** passes the information to the **CO\_serv** and informs the **listener**. The **listener** moves the file to a **tmp** directory, executes the **preprocessCAMPBELL.pl** script, and moves the preprocessed file (**.dat**) to the **Raw** directory or stores it in the text database archives, and sends it to the OH's database (SHEF). The **listener** process calls **routerLdadDecoder** to further decode the Campbell file (**.dat**) for the creation of the netCDF and SHEF-encoded files. The decoded file is stored and a notification is sent to the forecaster stating that new data are available. The SHEF-encoded file is forwarded to the NCF for distribution.

### Processes

```
LS     newLDADdataNotification
LS     CO_serv
PX2    listener
PX2    preprocessCAMPBELL.pl
PX2    CommsRouter LDAD_ROUTER
```



```

PX2   DataController LDAD_ROUTER LdadController.config
PX2   routerLdadDecoder
PX2   routerStoreTextEDEX
PX2   routerStoreEDEX
PX2   routerShefEncoderEDEX
PX2   distributeProduct
DX1   notificationServer

```

### Configuration Files (all in /data/fxa/LDAD/data)

```

LDADinfo.txt           (for listener)
*Station.txt          (for routerStoreEDEX)
LdadController.config (for DataController LDAD_ROUTER)
LdadPatterns.txt      (for routerLdadDecoder, routerStoreEDEX,
                      routerShefEncoder)
LARC.desc             (for routerLdadDecoder, routerStoreEDEX,
                      routerShefEncoderEDEX)

```

### Configuration Files in /awips/fxa/data

```

LdadWmoAwipsId.tbl    (for routerStoreTextEDEX)
LDADWmoID.cfg         (for routerShefEncoderEDEX)
edex-info.txt         (for routerStoreEDEX, routerShefEncoderEDEX)

```

### CAMPBELL.desc

The **\$LDAD\_DATA/data/CAMPBELL.desc** file requires no changes unless the Campbell data logger has been modified to collect data with PE codes that are not in the current file.

The file is directly coupled with the **SHEFcodes.cfg** file. The sequence of data group entries should be matched with the sequence of PE codes in **SHEFcodes.cfg** file.

Refer to Exhibit 8.10-1 for the Decode Campbell Data diagram.

#### 8.10.1 newLDADdataNotification

The **newLDADdataNotification** process uses the file name and a lookup table (**LDADinfo.txt**) to determine the type of data contained in the file and checks the LDAD products directory (**/data/Incoming**) periodically for Campbell files.

The **newLDADdataNotification** process creates and sends an IPC message to the **CO\_serv** process using **createAndSendIPCmessage**. The message notifies **CO\_serv** that there are Campbell files in the **/data/Incoming** directory.

If **newLDADdataNotification** fails to receive confirmation from **listener** within 5 minutes, or if an **fstat** on the file to transfer fails, the product gets moved to the **/data/ldad/Problem** directory using **moveFileToProblemDir** process. Otherwise, the

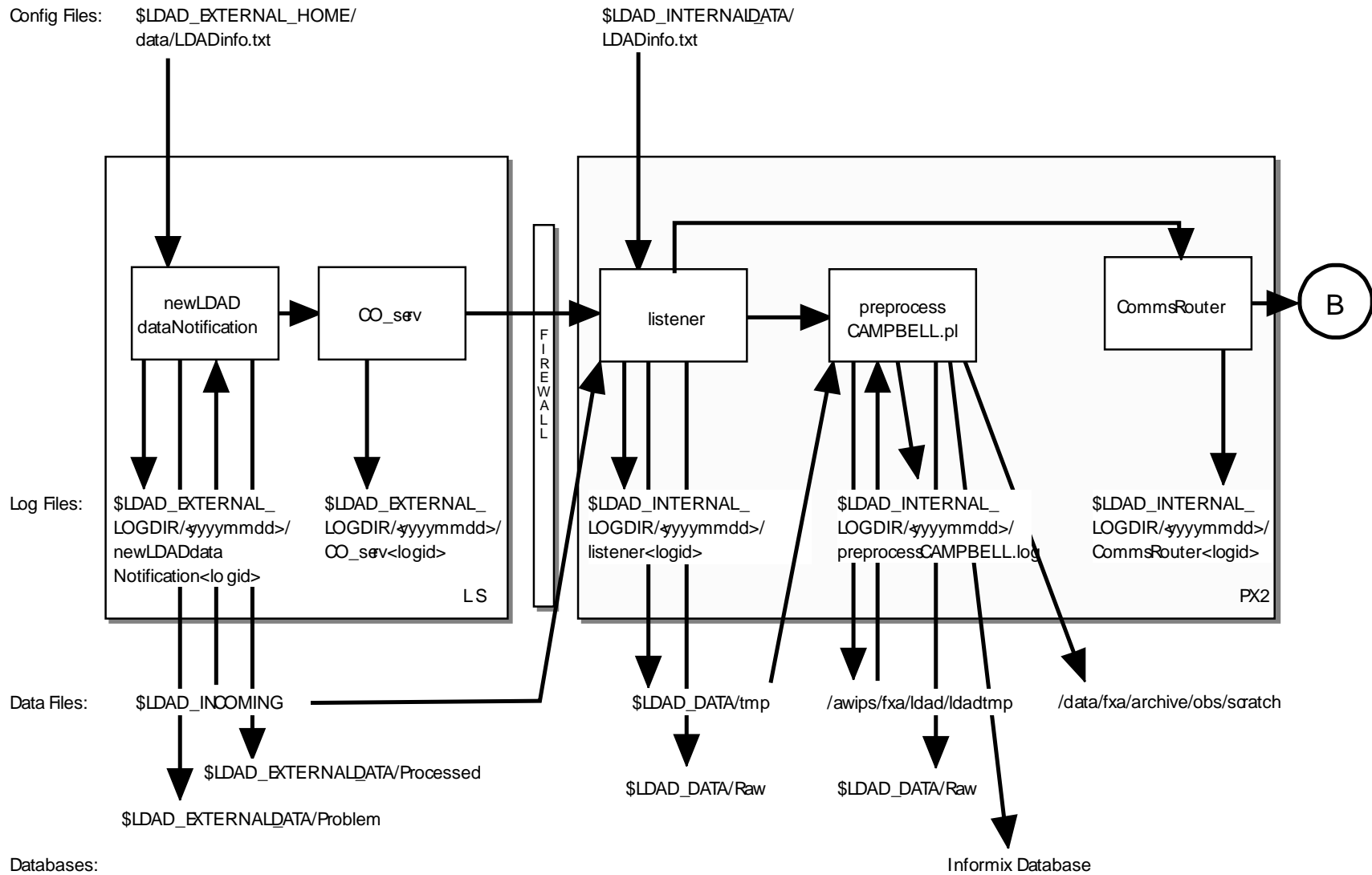

SMM 06/14/06

Exhibit 8.10-1. Decode Campbell Data (for LDAD) (Page 1 of 2)

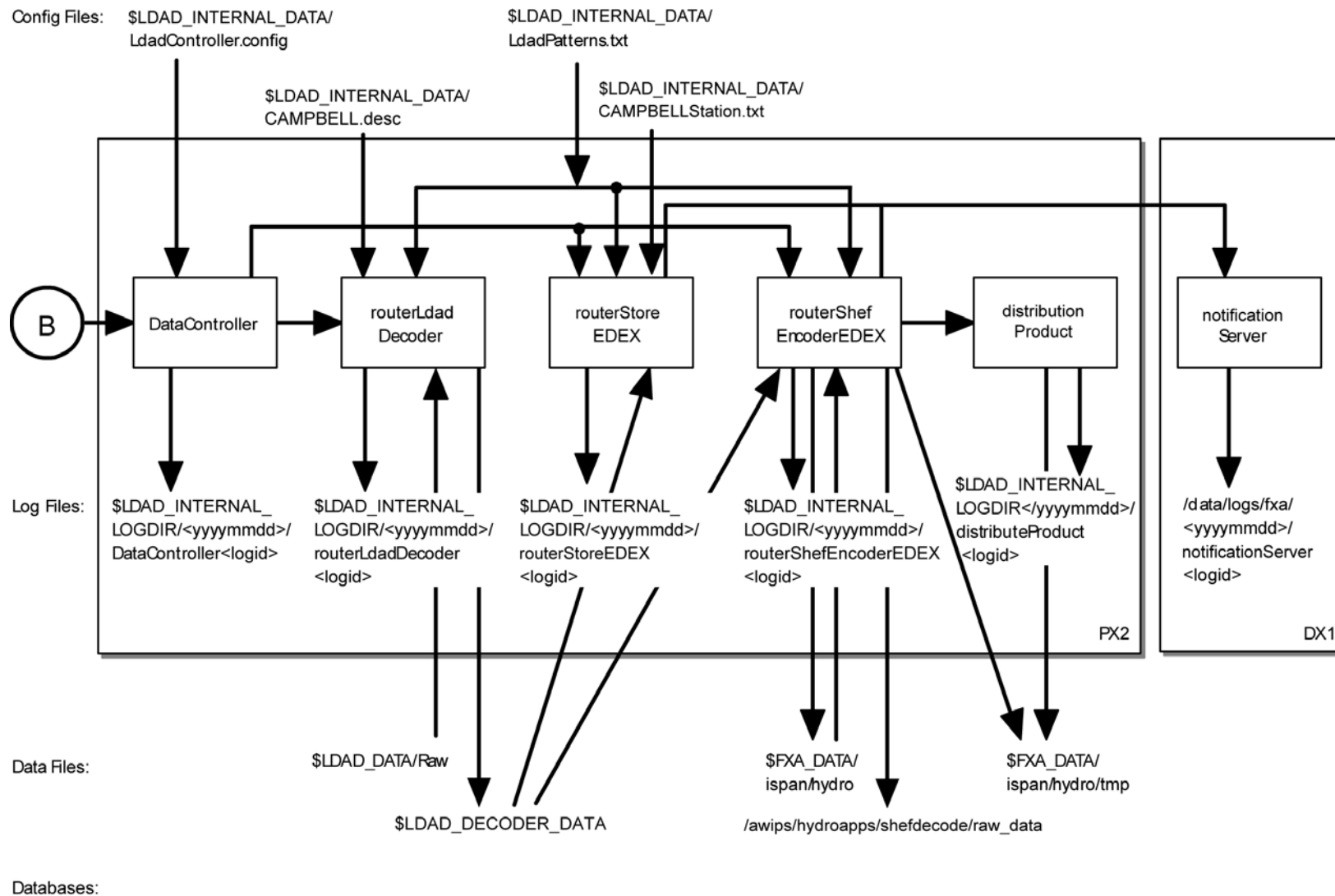

SMM 02/09/11

Exhibit 8.10-1. Decode Campbell Data (for LDAD) (Page 2 of 2)

“processed” files get moved to the `/data/ldad/Processed` directory using the `moveFileToProcessDir` process.

► **To Access and Read the newLDADdataNotification Log**

The `newLDADdataNotification` log resides on the active LS in the `$LOG_DIR` directory and records messages from the `newLDADdataNotification` process. Perform the following commands as user `ldad`:

```
TYPE:      cd $LOG_DIR/<yyyymmdd>
               ■      Where <yyyymmdd> is today’s date

TYPE:      ls -ltr newLDADdataNotification*
               ■      Displays the current day’s newLDADdataNotification
                       logs from earliest to latest

TYPE:      tail -f <logname>
               ■      Displays the latest registered messages as the log updates
```

**Log Message Format**

An entry at the beginning of this log looks like the following:

```
LOG-STATUS: Log file opened on host ls1-tbdw at Wed Apr 12 00:00:28 2006
00:00:28.906 newLDADdataNotification.c EVENT: newLDADdataNotification process
started
00:00:28.911 newLDADdataNotification.c EVENT: Reading /data/Incoming/ every 20
seconds
14:36:19.861 newLDADdataNotification.c EVENT: Processing :
/data/Incoming/ftpl.txt
14:36:21.053 newLDADdataNotification.c EVENT: waitForReply SUCCESS on
/data/Incoming/ftpl.txt
14:37:39.873 newLDADdataNotification.c EVENT: Processing :
/data/Incoming/CAMPBELLAEFW3311437.dat.973003031
14:37:39.882 newLDADdataNotification.c EVENT: Processing :
/data/Incoming/CAMPBELLAEFW3311437.SHEF
14:37:41.210 newLDADdataNotification.c EVENT: waitForReply SUCCESS on
/data/Incoming/CAMPBELLAEFW3311437.SHEF
```

The format of the log file consists of the following fields:

```
Time stamp      14:37:41.210
File name       newLDADdataNotification.c
Message type    EVENT:
Message string  waitForReply SUCCESS on
                /data/Incoming/CAMPBELLAEFW3311437.SHEF
```

**8.10.2 CO\_serv**

`CO_serv` initially sets up a socket (TCP/IP) and waits for connections. The notification received from `newLDADdataNotification` is passed across the firewall to the `listener` process on the internal side on the PX2.

► **To Access and Read the CO\_serv Log**

The **CO\_serv** log resides on the active LS in the directory **\$LOG\_DIR** and records messages from the **CO\_serv** process. Perform the following commands as user **ldad**:

- TYPE:**        `cd $LOG_DIR/<yyyymmdd>`  
                   ▪        Where **<yyyymmdd>** is today's date.
- TYPE:**        `ls -ltr CO_serv*`  
                   ▪        Displays the current day's **CO\_serv** logs from earliest to latest.
- TYPE:**        `tail -f <logname>`  
                   ▪        Displays the latest registered messages as the log updates.

**Log Message Format**

An entry at the beginning of this log looks like the following:

```
LOG-STATUS: Log file opened on host lsl-rnk at Wed Apr 12 00:00:17 2006
00:00:17.076 co_serv_main.c EVENT: CO_serv process started
00:05:07.791 co_serv_main.c EVENT: CO_serv received a socket connection at:
Apr12 06 00:05:07 GMT
00:05:07.801 co_serv_main.c EVENT: R message Received by CO_serv.....
00:06:36.988 co_serv_main.c EVENT: CO_serv received a socket connection at:
Apr12 06 00:06:36 GMT
00:06:36.995 co_serv_main.c EVENT: R message Received by CO_serv.....
00:13:48.283 co_serv_main.c EVENT: CO_serv received a socket connection at:
Apr12 06 00:13:48 GMT
00:13:48.291 co_serv_main.c EVENT: R message Received by CO_serv.....
```

The format of the log file consists of the following fields:

Time stamp	00:00:17.076
File name	co_serv_main.c
Message type	EVENT:
Message string	CO_serv process started

**8.10.3 listener**

The **listener** reads the **LDADinfo.txt** config file, sets up a socket, binds its local address so that the Client (**CO\_serv**) can send to it, and waits for the connection from the Client process. When the notification is received, the **listener** retrieves the Campbell file from the **/data/Incoming** directory on the active LS and copies it to the **\$LDAD\_DATA/tmp** directory on the PX2 inside the firewall. If the file requires no preprocessing, the **listener** moves the data file directly to the Raw directory and sends a verification when done.

The **listener** executes the **\$FXA\_HOME/ldad/bin/preprocessCAMPBELL.pl** script to preprocess the Campbell data files. The **listener** receives the fully qualified data file, the hostname used by notification routine, the port number of the process requiring

notification upon completion of the preprocessing, and other necessary information about the data file format from **CO\_serv**. Finally, the **listener** sends notification to the **CommsRouter LDAD\_ROUTER** that a product has been preprocessed.

### ► To Access and Read the listener Log

The **listener** log resides on PX2 in the directory **\$LOG\_DIR** and records messages from the **listener** process. Perform the following commands as user **ldad**:

- TYPE:** `cd $LOG_DIR/<yyyymmdd>`
- Where **<yyyymmdd>** is today's date.
- TYPE:** `ls -ltr listener*`
- Displays the current day's **listener** logs from earliest to latest.
- TYPE:** `tail -f <logname>`
- Displays the latest registered messages as the log updates.

### Log Message Format

An entry at the beginning of this log looks like the following:

```
LOG-STATUS: Log file opened on host px2-tbdw at Wed April 12 00:00:12 2006
00:00:12.616 listener.c EVENT: listener process started
14:37:40.146 listener.c DEBUG: do_G_Msg: rcp
ls1:/data/Incoming/CAMPBELLAEFW3311437.dat.973003031
/data/fxa/LDAD/tmp/CAMPBELLAEFW3311437.dat.973003031.973003060
14:37:41.059 listener.c EVENT: do_G_Msg: rcp completed for
CAMPBELLAEFW3311437.dat.973003031.973003060
14:37:41.146 listener.c DEBUG: do_G_Msg: pInfo->preprocessorScript=
<preprocessCAMPBELL.pl>
14:37:41.146 listener.c DEBUG: makePreprocessorCommandLine: rcp_cmd_buf=
</awips/dad/bin/preprocessCAMPBELL.pl
/data/fxa/LDAD/tmp/CAMPBELLAEFW3311437.dat.973003031.973003060 px 15009>
14:37:41.147 listener.c EVENT: do_G_Msg: Preprocessor Command Line=
</awips/ldad/bin/preprocessCAMPBELL.pl
/data/fxa/LDAD/tmp/CAMPBELLAEFW3311437.dat.973003031.973003060 px 15009>
```

The format of the log file consists of the following fields:

```
Time stamp      14:37:40:146
File name       listener.c
Message type    DEBUG:
Message string  do_G_Msg: rcp
ls1:/data/Incoming/CAMPBELLAEFW3311437.dat.973003031
                /data/fxa/LDAD/tmp/CAMPBELLAEFW3311437.dat.97300
                3031.973003060
```

#### 8.10.4 preprocessCAMPBELL.pl

The **preprocessCAMPBELL.pl** script copies the files from the **\$LDAD\_DATA/tmp** directory to the **/awips/fxa/ldad/ldadttmp** directory. There, it reformats the Campbell data files, appends the **abstime** string to the file names, and stores the preprocessed file (**.dat**) in the **\$LDAD\_DATA/Raw** directory and the SHEF file into the Postgres text database, archives it, and sends it to the OH database.

► **To Access and Read the preprocessCAMPBELL Log**

The **preprocessCAMPBELL** log resides on PX2 in the directory **\$LOG\_DIR** and records messages from the **preprocessCAMPBELL.pl** process. Perform the following commands as user **ldad**:

**TYPE:** `cd $LOG_DIR/<yyyymmdd>`

- Where **<yyyymmdd>** is today's date.

**TYPE:** `ls -ltr preprocessCAMPBELL*`

- Displays the current day's preprocessCAMPBELL logs from earliest to latest.

**TYPE:** `tail -f <logname>`

- Displays the latest registered messages as the log updates.

#### Log Message Format

An entry at the beginning of this log looks like the following:

```

<<<<<<<<<<<<<<<<<<<<<<<<<<<<<<<<<<<<<<<<<<<<<<<<<<<<<<<<<<<<<<<<<<<<<<<<<<<
<>    New Activity Log Started Wed April 12 14:37:41 UTC 2006
<<<<<<<<<<<<<<<<<<<<<<<<<<<<<<<<<<<<<<<<<<<<<<<<<<<<<<<<<<<<<<<<<<<<<<<<<
ARGV[0]: /data/fxa/LDAD/tmp/CAMPBELLAEFW3311437.dat.973003031.973003060
ARGV[1]: px
ARGV[2]: 15009
moveFile(): move
/data/fxa/LDAD/tmp/CAMPBELLAEFW3311437.dat.973003031.973003060 to
/data/fxa/LDAD/Raw/CAMPBELLAEFW3311437.dat.973003031.973003060
moveFile(): /data/fxa/LDAD/tmp/CAMPBELLAEFW3311437.dat.973003031.973003060
moved successfully.
    Failed to move Campbell CSV format file to /raw directory

<<<<<<<<<<<<<<<<<<<<<<<<<<<<<<<<<<<<<<<<<<<<<<<<<<<<<<<<<<<<<<<<<<<<<<<<<<<
<>    New Activity Log Started Wed April 12 14:37:41 UTC 2006
<<<<<<<<<<<<<<<<<<<<<<<<<<<<<<<<<<<<<<<<<<<<<<<<<<<<<<<<<<<<<<<<<<<<<<<<<<<<
ARGV[0]: /data/fxa/LDAD/tmp/CAMPBELLAEFW3311437.SHEF.973003060
ARGV[1]: px
ARGV[2]: 15009
getPE():
getAwipsId():
getAfosPil():
    afos ID =
storeInTextDB():
    storeCommand =

```

```

textdb -w < /data/fxa/LDAD/tmp/CAMPBELLAEFW3311437.SHEF.973003060
    Failed to store product to text database.
getSiteCommissionStatus():
commission status = 1
Site is commissioned. No need to send observation to AFOS
archiveObs():
moveFile(): move /data/fxa/LDAD/tmp/CAMPBELLAEFW3311437.SHEF.973003060 to
/data/fxa/archive/obs/scratch/CAMPBELLAEFW3311437.SHEF.973003060.2006041214374
2
moveFile(): /data/fxa/LDAD/tmp/CAMPBELLAEFW3311437.SHEF.973003060 moved
successfully.
    Archival was successful...
Script Done ...
~

```

The format of the log file consists of the following fields:

```

File name          moveFile():
Message string /data/fxa/LDAD/tmp/CAMPBELLAEFW3311437.SHEF.973003060 moved
successfully

```

### 8.10.5 LDAD\_ROUTER

The **LDAD\_ROUTER** (registered **LDAD CommsRouter**) is responsible for transporting data notifications from the data acquisition processes to the **DataController** processes. The main function of the **LDAD\_ROUTER** is message passing; it does no data processing. The router provides a known location where the data acquisition processes can send data messages.

#### ► To Access and Read the CommsRouter Log

The **LDAD\_ROUTER CommsRouter** log resides on PX2 in a time-stamped directory under **\$LOG\_DIR**. Perform the following commands as user **ldad**:

```

TYPE:      cd $LOG_DIR/<yyyymmdd>
               ■ Where <yyyymmdd> is today's date.

```

```

TYPE:      ps -wef |grep ldad
               ■ Displays the ldad processes. Notice the PID of the
                 CommsRouter process that is owned by user ldad.

```

```

TYPE:      ls -ltr Comms*
               ■ Displays the latest logs.

```

**NOTE:** The **CommsRouter** log containing the PID of the **LDAD\_ROUTER** process is the **LDAD\_ROUTER CommsRouter** log.

```

TYPE:      tail -f <logname>
               ■ Displays the log as it updates.

```



## Log Message Format

An entry in the log should look like the following:

```
LOG-STATUS: Log file opened on host px2-tbdw at Wed Apr 12 00:00:09 2006
00:00:09.558 CommsReceiver.C EVENT: NCF_ENTRY CRMsg Pattern:
^[0-9.]*[^\m]([\^s]([\^a]([\^s]([\^_]([\^q]([\^c]))))))

.*\.decoded$|(. *\. [0-9]+)|(^ [0-9]*\.msas_gc\.* )$|.* /Text/. *\. [0-9]+
14:37:42.639 CommsReceiver.C EVENT: NCF_ENTRY DSMsg:
CAMPBELLAEFW3311437.dat.973003031.973003060 1 45
14:37:42.657 CommsReceiver.C EVENT: NCF_ENTRY DSMsg:
CAMPBELLAEFW3311437.SHEF.973003060 1 36
14:37:44.912 CommsReceiver.C EVENT: NCF_ENTRY DSMsg:
973003060.CAMPBELLAEFW3311437.decoded 1 62
```

The log consists of the following fields:

Time stamp	14:37:44.912
File name	CommsReceiver.C
Message type	EVENT:
Message string	NCF_ENTRY DSMsg: 973003060.CAMPBELLAEFW3311437.decoded 1 62

The **LDAD\_ROUTER CommsRouter** is started automatically at system reboot time or it can be started manually. The **CommsRouter** runs continuously, exiting only when killed by the restart program.

### 8.10.6 DataController

The **DataController** is responsible for creating the decoder and storage processes (as child processes), restarting them if they exit, routing appropriate messages to them, and queuing incoming data messages until the decoder and storage processes are ready. As data messages are stored in the queue, the size of the processes grows.

The **DataController's** main program creates a **DataRouting** manager object when it first starts up and invokes a member function to start the **routerLdadDecoder**, **routerStoreNetcdf**, and **routerShefEncoder** processes by reading and executing the **LdadController.config** file. The file resides on the **\$LDAD\_INTERNAL\_DATA** directory and contains the names of the above processes to start/restart, a restart flag, and end of file (**eof**) designators to alert the Data Routing Manager that there are no more processes listed in the file.

The **LDAD\_ROUTER** sends product-received notifications to the **DataController**. When the processes first start up, they send messages containing their IPC addresses and process numbers to the **DataController**. The processes send the **DataController** a data request message and a ready-to-receive data message. In response, the **DataController** stores the processes' ID information and data requests, and sends a message to the requesting processes (if a message is available). The **DataController** waits to receive another ready message from the processes before sending any more data messages. The

**DataController** queues any messages it receives from the **LDAD\_ROUTER** until the processes send another ready message.

► **To Access and Read the DataController Log**

The **DataController** log resides on PX2 in a time-stamped directory under **\$LOG\_DIR**. Perform the following commands as user **ldad**:

```
TYPE:      cd $LOG_DIR/<yyyymmdd>
               ■ Where <yyyymmdd> is today's date.

TYPE:      ls -ltr DataController*
               ■ Displays the latest log for the DataController
                 LDAD_ROUTER process.

TYPE:      tail -f <logname>
               ■ Displays the current log as it updates with the latest
                 messages.
```

### Log Message Format

An entry in the log should look like the following:

```
LOG-STATUS: Log file opened on host px2-tbdw at Tue Apr 24 00:00:04 2012
00:00:04.414 DataCaptReceiver.C EVENT: DataReqMsg: pattern = (*.\[0-9]*o|\.[0-9]+)|(^[0-9]*\.msas_gc\..*)$
00:00:04.414 getCommsData.C EVENT: Data Request message sent to LDAD_ROUTER.
00:00:05.430 DataCaptReceiver.C EVENT: DataReqMsg: pattern = ^[0-9.]*[^\m]([\s]([\a]([\s]([\_]([\q]([\c])))))).*\.decoded$
00:00:05.430 getCommsData.C EVENT: Data Request message sent to LDAD_ROUTER.
00:00:06.448 DataCaptReceiver.C EVENT: DataReqMsg: pattern = */Text/*.\[0-9]+
00:00:06.448 getCommsData.C EVENT: Data Request message sent to LDAD_ROUTER.
00:00:07.465 DataCaptReceiver.C EVENT: DataReqMsg: pattern =
.*(\.not_a_mesonet|alert_wl.*|alert_r5.*|..LARC.*)\.decoded
```

The log file consists of the following fields:

```
Time stamp      00:00:05.430
File name       DataCaptReceiver.C
Message type    EVENT:
Message string  EVENT: DataReqMsg: pattern = ^[0-9.]*[^\m]([\s]([\a]([\s]([\_]([\q]([\c])))))).*\.decoded$
```

#### 8.10.7 routerLdadDecoder

The **routerLdadDecoder** process is spawned by the **DataController** as specified in the **LdadController.config** file. The **routerLdadDecoder** process sends a data request to the **DataController** for the CAMPBELL products it wishes to receive by specifying product header patterns of interest. On receipt of a notification from the **DataController**

that a product of interest has arrived, the **routerLdadDecoder** reads the directory containing the raw files, **\$LDAD\_DATA/Raw**.

The **routerLdadDecoder** process reads each file and stores them via serialized data files to the **\$LDAD\_DECODED\_DATA** directory. The serialized file name is sent back through the **LDAD\_ROUTER** to notify registered LDAD storage processes of the arrival of each LDAD decoded product.

### ► To Access and Read the routerLdadDecoder Log

The **routerLdadDecoder** log resides on PX2 in a time-stamped directory under **\$LOG\_DIR**. Perform the following commands as user **ldad**:

```
TYPE: cd $LOG_DIR/<yyyymmdd>
      ■ Where <yyyymmdd> is today's date.

TYPE: ls -ltr routerLdadDecoder*
      ■ Displays the latest log for the routerLdadDecoder process.

TYPE: tail -f <logname>
      ■ Displays the current log as it updates with the latest
        messages.
```

### Log Message Format

An entry in the log should look like the following:

```
LOG-STATUS: Log file opened on host px2-tbdw at Wed Apr 12 00:00:33 2006

14:33:04.580 DataCaptReceiver.C USE: ProdLen 50
14:33:04.601 DataCaptReceiver.C USE: ProdLen 58
14:33:06.556 DataCaptReceiver.C USE: ProdLen 31
14:36:22.029 DataCaptReceiver.C USE: ProdLen 18
14:37:42.662 DataCaptReceiver.C USE: ProdLen 45
14:37:42.692 LdadRoutines.C EVENT: Processing [1/1] =
CAMPBELLAEFW3311437.dat.973003031.973003060
14:37:44.912 LdadRoutines.C EVENT: LdadRoutines::pingLdadRouter(),
'$LDAD_DECODED_DATA/ 973003060.CAMPBELLAEFW3311437.decoded', sent to
LDAD_ROUTER
```

The log file consists of the following fields:

```
Time stamp      14:37:44.912
File name       LdadRoutines.C
Message type    EVENT:
Message string  LdadRoutines::pingLdadRouter(),
                '$LDAD_DECODED_DATA/
                973003060.CAMPBELLAEFW3311437.decoded', sent to
                LDAD_ROUTER
```

### 8.10.8 routerStoreEDEX

The **routerStoreEDEX** process is spawned by the **DataController** as specified in the **LdadController.config** file. The **routerStoreEDEX** process sends a data request to the **DataController** for serialized decoded Campbell files in netCDF format. When notified by the **DataController** that a product of interest has arrived, **routerStoreNetcdf** reads the directory containing the files, **\$LDAD\_DECODED\_DATA**. The **routerStoreEDEX** process stores the files in the **/data\_store/ldad** directory in the XML format and sends a notification to the **EDEX**.

► **To Access and Read the routerStoreEDEX Log**

The **routerStoreEDEX** log resides on PX2 in a time-stamped directory under **\$LOG\_DIR**. Perform the following commands as user **ldad**:

- Type:** `cd $LOG_DIR/<yyyymmdd>`
- Where **<yyyymmdd>** is today's date.
- Type:** `ls -ltr routerStoreEDEX*`
- Displays the latest logs for the **routerStoreEDEX** process.
- Type:** `tail -f <logname>`
- Displays the log as it updates with the latest messages.

#### Log Message Format

An entry in the log should look like the following:

```
01:40:22.803 routerStoreEDEX.C EVENT: 1335231622.alert_r5.decoded
processing completed
01:45:22.712 routerStoreEDEX.C EVENT: NCF_ENTRY
/data/fxa/LDAD/decoded/1335231922.alert_r5.decoded
01:45:22.733 routerStoreEDEX.C EVENT: NCF_STORED to
/data_store/ldad/LDAD.hydro.1335231922.alert_r5.decoded.xml
01:45:22.733 routerStoreEDEX.C EVENT: 1335231922.alert_r5.decoded
processing completed
01:45:22.740 routerStoreEDEX.C EVENT: NCF_ENTRY
/data/fxa/LDAD/decoded/1335231922.RAWS.decoded
01:45:22.773 routerStoreEDEX.C EVENT: NCF_STORED to
/data_store/ldad/LDAD.mesonet.1335231922.RAWS.decoded.xml
01:45:22.774 routerStoreEDEX.C EVENT: 1335231922.RAWS.decoded
processing completed
01:50:22.774 routerStoreEDEX.C EVENT: NCF_ENTRY
/data/fxa/LDAD/decoded/1335232222.alert_r5.decoded
01:50:22.790 routerStoreEDEX.C EVENT: NCF_STORED to
/data_store/ldad/LDAD.hydro.1335232222.alert_r5.decoded.xml
01:50:22.790 routerStoreEDEX.C EVENT: 1335232222.alert_r5.decoded
processing completed
```

### 8.10.9 *routerShefEncoderEDEX*

The **routerShefEncoderEDEX** process is spawned by the **DataController** as specified in the **LdadController.config** file. The **routerShefEncoderEDEX** process sends a data request to the **DataController** for serialized decoded files. On receipt of a notification from the **DataController** that a product of interest has arrived, the **routerShefEncoderEDEX** reads the directory containing the files, **\$LDAD\_DECODED\_DATA**. The files there are SHEF-encoded and moved to the **/data\_store/ldad** directory. The **routerShefEncoderEDEX** process sends a notification to the **EDEX**. Once the SHEF-encoded data file is stored in the **/data\_store/ldad** directory, the **routerShefEncoderEDEX** saves a copy of the file in the **/tmp** directory and calls the **distributeProduct** process to send the file to the NCF over the WAN.

#### ► **To Access and Read the routerShefEncoderEDEX Log**

The **routerShefEncoderEDEX** log resides on PX2 in a time-stamped directory under **\$LOG\_DIR**. Perform the following commands as user **ldad**:

**TYPE:**        `cd $LOG_DIR/<yyyymmdd>`  
                   ▪        Where **<yyyymmdd>** is today's date.

**TYPE:**        `ls -rtal routerShefEncoderEDEX*`  
                   ▪        Displays the latest logs for the **routerShefEncoderEDEX** process.

**TYPE:**        `tail -f <logname>`  
                   ▪        Displays the current log as it is updated with the latest messages.

#### **Log Message Format**

An entry in the log should look like the following:

```
01:50:22.775 LdadStorage.C EVENT: LdadStorage::separatePatterns () <[-999
]> from <-999>

01:50:22.776 ShefStorage.C EVENT: TZ= GMT

01:50:22.794 routerShefEncoderEDEX.C EVENT: NCF_STORED to
/data_store/ldad/SXUS44 KWOHshef.1335232222

01:50:22.795 checkWmoHeader.C EVENT: checkWmoHeader()

01:50:22.795 checkWmoHeader.C EVENT: checkWmoHeader() : data contains a
WMO header.

01:50:22.795 SHEF_format.C EVENT: SHEF_format::sendToProductWan -> data
contains a WMO header.

Creating a dummy file (zero bytes).
```

```
01:50:22.817 SHEF_format.C EVENT: SHEF_format::sendToProductWan ->
system(distributeProduct -a DEFAULTNCF -e /tmp/shefwanECAx2f KSTORRZSTO
/tmp/shefwanECAx2f_msg);

01:50:22.817 SHEF_format.C EVENT: shef data has sent to WAN successfully!

01:50:22.817 routerShefEncoderEDEX.C EVENT: Finished
```

### 8.10.10 *distributeProduct*

The **distributeProduct** process creates a product message and submits it for distribution across the AWIPS WAN to the addressed sites. The **distributeProduct** process first prepares the product by creating the WAN communications header and prepending the header to a temporary copy of the product. Distribution requests, enclosing the temporary copy of the product, are subsequently made through the **msg\_send** utility program.

#### ► To Access and Read the **distributeProduct** Log

The **distributeProduct** log resides on PX2 in a time-stamped directory under **\$LOG\_DIR**. Perform the following commands as user **ldad**:

```
TYPE:      cd $LOG_DIR/<yyyymmdd>
               ■ Where <yyyymmdd> is today's date.

TYPE:      ls -ltr distributeProduct*
               ■ Displays the latest logs for the distributeProduct process.

TYPE:      tail -f <logname>
               ■ View the current log as it updates with the latest messages.
```

### Log Message Format

An entry in the log should look like the following:

```
LOG-STATUS: Log file opened on host px2-tbdw at Wed Apr 12
19:30:59 2006
19:30:59.690 MHSProduct.C PROBLEM: Product
(/data/fxa/ispan/hydro/temp/A_format.973020657) is empty.
19:30:59.853 MHSProduct.C EVENT: Sending attachments
(/data/fxa/ispan/hydro/temp/A_format.973020657)
only. Attachments are assumed to contain correct communications
header.
19:31:02.504 MHSProduct.C EVENT: Product request (KSTORRZLDA) was
successfully
submitted to the MHS request server for distribution.
      Message Attributes:
          Request ID: TBDW-25380
          To: DEFAULTNCF
          Priority: 0
          Type: Routine
          Subject:
          Handling Action: 0
19:31:02.518 MHSProduct.C EVENT: TBDW-25380
```

~

The log file consists of the following fields:

```

Time stamp          19:31:02.504
File name           MHSProduct.C
Message type        EVENT:
Message string      Product request (KSTORRZLDA) was successfully
                    submitted to the MHS request server for
                    distribution.
                    Message Attributes:
                    Request ID: TBDW-25380
                    To: DEFAULTNCF
                    Priority: 0
                    Type: Routine
                    Subject:
                    Handling Action: 0

```

### 8.10.11 notificationServer

The **notificationServer** provides information to its display clients that a new version of a display product has become available. Data acquisition processes send data notification messages to the **notificationServer**, which acts as a bridge between the data acquisition and workstation display components of AWIPS.

#### ► To Access and Read the notificationServer Log

The **notificationServer** log resides on the DX1 in the directory **\$LOG\_DIR**. This log records messages from the **notificationServer** process. Perform the following commands as user fxa:

```

TYPE:      cd $LOG_DIR/<yyyymmdd>
                ■ Where <yyyymmdd> is today's date.

```

```

TYPE:      ls -ltr notificationServer*
                ■ Displays the current day's notificationServer logs from
                  earliest to latest.

```

```

TYPE:      tail -f <logname>
                ■ Displays the latest registered messages as the log updates.

```

#### Log Message Format

An entry at the beginning of the log looks like the following:

```

LOG-STATUS: Log file opened on host dx1-rnk at Wed Apr 12 00:00:31 2006
00:00:31.822 NotificationServer.C DIAG: Tried to generate notifications for
key: 3700 but the data notify time: 25.23 3HR does not match any times on the
inventory.
00:00:35.948 GridAccessor1.C EVENT: Updating inventory info for MRF

```

-----

```

Process ID of anonymous target: 29574
Host: lx2-rnk
Port number: 3231
NORMAL PRIORITY CONNECTION
Connection created: Apr 12 06 16:25:32 GMT. Initiated by connecting process.
Last time this connection was used: Apr 12 06 23:55:49 GMT
Sent messages since last stat: 4
Bytes per message (Avg/Min/Max): 544/540/548
No messages have been received since last stat report.

```

The format of the log file consists of the following fields:

```

Time stamp          00:00:31.822
File name           NotificationServer.C
Message type        DIAG:
Message string      Tried to generate notifications for key: 3700
                   but the data notify time: 25.23 3 hour does not
                   match any times on the inventory.

```

### 8.11 *Acquire Sutron Data*

Data collection from Sutron gauges is carried out by automating a normally interactive session using the **cu** communication protocol. There is a Server program (**CO\_serv**) and a Client program (**tell\_co**). The Server program is always running, waiting for, and processing requests to collect data from a particular gauge from the Client program. The Client program can be invoked from a shell script, as a cron job, or directly from a command line. A feature of the Client program is that it retrieves all necessary information regarding collection and storage of data from system tables in the AWIPS database. The Client and Server programs use sockets to communicate across a TCP/IP LAN. Data from a gauge are SHEF-encoded prior to storage on AWIPS. The **.dat** file is moved into the **Raw** directory, while the SHEF file is stored into the text database, archived, and sent to the OH's database during preprocessing. The **.dat** file is forwarded to the **ldadDecoder** process to further decode the Sutron data for creation of the netCDF and SHEF-encoded files.

#### Processes

```

LS    callSite.ksh
LS    process_expect
LS    CO_serv
LS    sutron
PX2   listener
PX2   tell_co
PX2   ldadServer
LX    ldadScheduler
DX1   notificationServer

```

#### Configuration Files (all in /data/fxa/LDAD/data)

```

LDADinfo.txt          (for listener)
SUTRONStation.txt    (for tell_co, ldadScheduler)

```



userDescriptions	(for <b>ldadScheduler</b> )
usrpro	(for <b>ldadScheduler</b> )
gageinfo	(for <b>ldadScheduler</b> )
gageinfoSutron.txt	(for <b>ldadScheduler</b> )
gageDescriptions	(for <b>ldadScheduler</b> )
SHEFcodes.cfg	(for <b>ldadScheduler</b> )
userSessList	(for <b>ldadScheduler</b> )
gageSessList	(for <b>ldadScheduler</b> )

### **LDADinfo.txt**

The file should contain the following entry:

```
SUTRON | SUTRON | 89 | 90 | CVS_TYPE | hydro | preprocessSUTRON.pl |
```

Once the file is installed, this line should not be modified.

### **SUTRONStation.txt**

This file must be updated whenever a gauge is added to or dropped from the current Sutron datalogger list. To add a new Sutron gauge, find out the following gauge information to create a new entry in the station table format (\* indicates a mandatory field):

- **Provider ID:** Data provider station or gauge ID (\*)
- **AFOS(HB5) ID:** The AFOS or Handbook 5 ID (NWS assigned)
- **Station Name:** Text name of station
- **Elevation:** Station elevation (m) (\*)
- **Latitude:** Station Latitude (decimal degrees, north positive) (\*)
- **Longitude:** Station Longitude (decimal degrees, east positive) (\*)
- **Local Time Zone:** Reporting time zone (e.g., UTC, PST8PDT) (\*). See Note.
- **Location Description:** Station location/address (Text)
- **Station Type:** Station type (e.g., tower, surface, floating platform, etc.)
- **Number of Instruments:** Number of reporting instruments for the station
- **Number of Reporting Levels:** Number of data reporting levels. Level information should be provided in the instrument table
- **Maintenance/Calibration Schedule:** Frequency of maintenance/calibration
- **Site Description:** Text description of the site surroundings

The entries are sorted alphabetically by the gauge ID.

This file must be identical on the PX2 and on LS1!

**NOTE:** The local time zone for Sutron gauges is always GMT since the Sutron Decoder already converts the observation times into GMT times.

### userDescriptions

This file is used by the **ldadScheduler** process to get the descriptions of users. When read in, blank lines and lines beginning with # are skipped. All other lines should have the following format:

```
<user ID>|<user description>
```

A blank user description is denoted by having the line end immediately following the | character (a vertical bar or “pipe”).

This file should not be modified manually. It should only be written to by the **ldadScheduler** (specifically, the **LdadSchedulerServer.C** routine).

### usrpro

The user file (**usrpro**) is made up of zero to n lines, each line holding the following information (note that the lines are so long that they are wrapped in the interests of readability). Columns containing “??” are not used at this time.

```
<ID>|<protocol>|<IP address>|<phone number>|<login>|<password (encrypted)>|??|<file to receive>|<file to send>|??|??|<data collection session file>|<data dissemination session file>|<local directory>|<remote directory>|??... (columns 16 through 36 have unknown meanings)...|<IP address>|
```

- The <protocol> is either “F” for FTP, “X” for Xmodem, “Y” for Ymodem, “Z” for Zmodem, or “K” for Kermit.
- The <IP address> designates the host to FTP to, if the protocol is “F,” or the terminal server otherwise. <IP address> appears in two places in the above column listing: columns 3 and 37. In reality, only one of the two columns is used. For the FTP protocol, only column 3 has the address in it, and column 37 is left blank. If any other protocol is being used, column 37 has the address in it, and column 3 is left blank.
- The <phone number> field is unused if the protocol is “F.”
- The <file to receive> and <file to send> fields are mutually exclusive. Only one may be specified. The <file to receive> field indicates that the user is a collection user, and the <file to send> indicates that the user is a dissemination user. All other columns are tracked when read in; when written out, the same values are placed in them as were originally found.

### gageinfo

The **gageinfo** file contains a list of Handbook 5 and Sutron gauges. It is updated periodically as Sutron gauges are added and removed with the **ldadScheduler**. Whenever

a gauge is added or dropped from the current list, it should be updated here and in the following files :

```
$LDAD_DATA/data/gageinfoSutron.txt
$LDAD_DATA/data/gaugeDescriptions
```

The following fields must be present for each gauge (see Note):

- **Gauge ID:** A five-character instrument ID.
- **Protocol Type:** C for data collection, D for dissemination.
- **Phone#:** The dial-out phone number can be in any format. However, if the gauge has the voice message first, several pauses are included in the phone number. Depending on the length of the voice message, add more pauses if the one listed here is not enough. The pause is entered by comma (,) and is ended with a \*9. If a phone number contains a pause extension, make sure the phone number is enclosed by single quotes('). For example, '1-605.886.2473,,,,,\*9'.
- **Session File:** Use SUTRON\_coll\_sess exactly.
- **SHEF File:** 1 = Yes; 0 = No.
- **Storage Type:** S.
- **Baud Rate:** Use **9600** for Sutron gauges.
- **Terminal Server (tty):** Use 8n1out for Sutron gauges.

The fields are separated by vertical bars (|); empty fields are for future use. A number nine (9) in front the phone number allows the user to dial out. An example follows:

```
ADAM4|C| |916166763810| | | |SUTRON_coll_sess|1|S||9600|e| |8n1out|
```

**NOTE:** The **rcvprog** field indicates the receiving program (e.g., FTP) for data collection. This field is used as the custom gauge ID if the gauge is not owned by the NWS.

### **gageinfoSutron.txt**

The file should be updated along with the **gageinfo** file when adding/dropping Sutron gauge(s). There are at least four fields for each Sutron gauge to be entered when adding a gauge; the fields are as follows:

- **Gauge ID:** A five-character instrument ID (i.e., ADAM4).
- **Local Time Zone:** Time zone where the Sutron gauges are located (e.g., PST, CDT, GMT, etc.)
- **Data Array ID for Storage Area 1:** Four digit array ID.
- **Observation Field Skip Bit Map for Array ID Number One:** This is an eight-bit field used to mark the observation fields to be ignored.

- **Bit Map for Observation data Fields in PE Codes for Storage Area 1 in Hexadecimal Format:** This is a 32-bit code (see Note). The leftmost byte is designed to ignore collected data fields and the other three are used to map the type of data collected relevant to the PE codes listed in the **SHEFcodes.cfg** file.
- **Data Array ID for Storage Area 1:** Four digits array ID for gauge collection data and storing in Storage Area 2.
- **Bit Map for Collecting Data Fields in PE Codes for Storage Area 2:** Same format as Storage Area 1 if the gauge collects data and stores it in Storage Area 2.

**NOTE:** Current design can accommodate a maximum of eight data fields only for a Sutron gauge and a maximum of 32 PE codes collected by all Sutron gauges. If an individual gauge collects more than eight different data fields or if the total number of the PE codes collected by the Sutron gauges exceeds 32, these fields will have to be expanded to incorporate the changes.

### gaugeDescriptions

The file is used to get the site descriptions and should be updated using the **ldadScheduler** when a new Sutron gauge is added. Each entry (line) should have the following format:

```
<gauge ID> | <site description>
```

For example, an entry for the ARTN6 would be as follows:

```
ARTN6 | Watertown, NY
```

The file is sorted by state abbreviations. However, it is displayed based on the alphabetical order of the gauge IDs.

### SHEFcodes.cfg

The file is designed specifically for Sutron gauges to enable creation of SHEF-encoded files (**.shf**). It contains the PE codes currently collected by Sutron CR10X and 8210/8200A gauges. The elements in the file are presented in alphabetical order and should be updated every time a new PE code is added to the file. When this file is modified, the LDAD system has to be shut down and restarted again.

The codes are used in constructing the 4-byte PE code bit map in the **gageinfoSutron.txt** file. It is also used as the base for creating and updating the **\$LDAD\_DATA/data/SUTRON.desc** file.

Refer to Exhibit 8.11-1 for the Acquire Sutron Data data flow diagram.

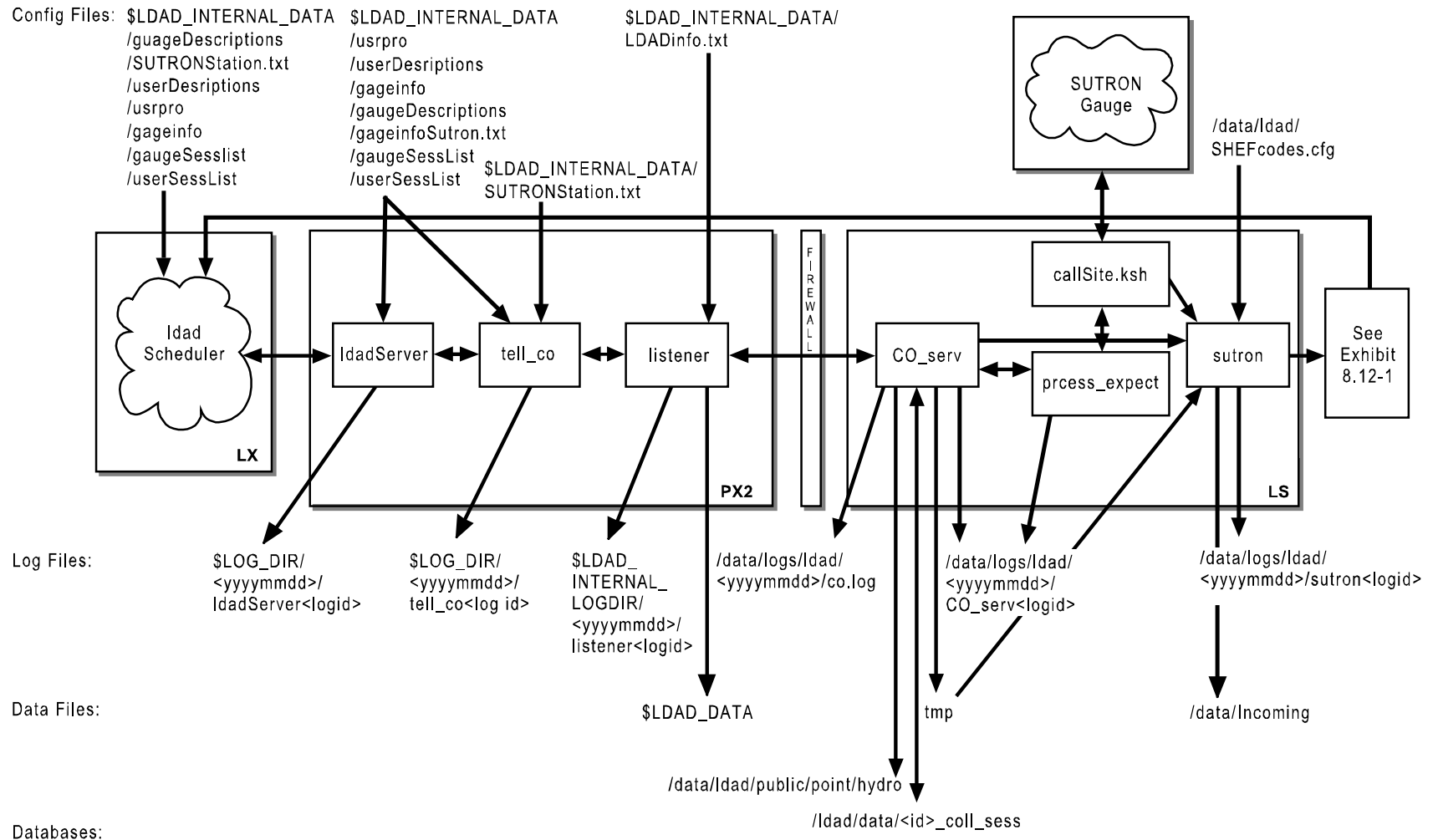

SMM\_033111

**Exhibit 8.11-1. Acquire Sutron Data (for LDAD)**

### 8.11.1 *User Interface: ldadScheduler*

The `ldadScheduler`'s function is to perform certain data acquisition/dissemination events on an automatic basis at specified time intervals (in the background). Access to the Scheduler's functions is via a GUI invoked by selecting Collection/Dissemination... from the Surface pull-down menu.

The `ldadScheduler` provides a window with which the forecaster may create, view, and manipulate scheduled LDAD requests. The Sutron data collection can be scheduled for daily, multiple, or one time request. The Scheduler allows the forecaster to create a new request and add it to the request list. The request is submitted to the `ldadServer`, which uses `sendLDADnotification.pl` to create the request. If it is a one-time request, the forecaster can monitor its progress using a status dialog. If any errors are encountered during the data logging, an error message is formulated and sent to the forecaster workstation for display. In addition, Sutron gauge dialing status information is sent by the listener and displayed by the `ldadScheduler`.

The `ldadScheduler` registers with the `ldadServer` providing a callback routine for update notifications. The session file contents are registered first, and the status messages and ID updates so that when registering with `ldadServer`, the ID lists sent by `ldadServer` will be captured and kept.

It also registers with the FAC for notifications of changes to the existing requests file, and creates a FAC lock for the file to be used for locking it for "reads" and "writes." The existing requests get read so as to fill the tree view with the requests that have been created.

### 8.11.2 *ldadServer*

The **ldadServer** allows multiple clients to connect to it and submit requests with intervals and durations that are honored according to their intervals until they expire.

New client initialization is performed by sending the gauge and user lists to the newly registered client. The **ldadserver** process creates a new message with the current active list that is broadcast all registered clients.

To honor the specified request, the **ldadServer** creates the command to be executed and sends the data collection request to the **tell\_co** process.

The **ldadServer** receives LDAD messages from clients; messages to create and delete gauges and users; and messages requesting the contents of a session file, or specifying a session file's contents.

► **To Access and Read the ldadServer Log**

The **ldadServer** log resides on the PX2 in the **\$LOG\_DIR** directory and records messages from the **ldadServer** process. Perform the following commands as user **ldad**:

- TYPE:** `cd $LOG_DIR/<yyyymmdd>`
- Where **<yyyymmdd>** is today's date.
- TYPE:** `ls -ltr ldadServer*`
- Displays the current day's **ldadServer** logs from earliest to latest.
- TYPE:** `tail -f <logname>`
- Displays the latest registered messages as the log update.

### Log Message Format

An entry at the beginning of the log looks like the following:

```
LOG-STATUS: Log file opened on host px2-tbdw at Wed Apr 12 20:11:03 2006
16:11:37.334 LdadSchedulerServer.C PROBLEM: The gauge "ADAM4" specified in
gageinfoSutron.txt was not found in gageinfo.txt. This gauge will not be used.
16:11:37.345 LdadSchedulerServer.C PROBLEM: The gauge "ADAM4" specified in
gageinfoSutron.txt was not found in gageinfo.txt. This gauge will not be used.
20:11:03.470 Connection.C EVENT: WARNING: this process wants to use target
LDAD_SCHEDULE_SERVER which is assigned to run on px2-tbdw but the current host
is px2-tbdw
20:11:03.492 LdadSchedulerServer.C PROBLEM: The gauge "ADAM4" specified in
gageinfoSutron.txt was not found in gageinfo.txt. This gauge will not be used.
20:12:12.926 SignalClient.C EVENT: Signal 15 (Terminate) received for clean
shutdown
```

The format of the log consists of the following fields:

Time stamp	16:11:37.345
File name	LdadSchedulerServer.C
Message type	PROBLEM:
Message string	The gauge "ADAM4" specified in gageinfoSutron.txt was not found in gageinfo.txt. This gauge will not be used.

### 8.11.3 *tell\_co*

The **ldadServer** process invokes the Client program **tell\_co**, the main controller process providing the Sutron ID. The **tell\_co** function retrieves all information regarding a specified gauge from the LDAD configuration files. This includes all communication details, the name of the session file to use, as well as the location to store the data on AWIPS and whether SHEF encoding is required. It formats an interprocess message containing the aforementioned information, opens a socket to the **listener** and sends a get Sutron Message "IPC" message to the listener.

► **To Access and Read the tell\_co Log**

The **tell\_co** log resides on the PX2 in the **\$LOG\_DIR** directory and records messages from the **tell\_co** process. Perform the following commands as user **ldad**:

- TYPE:**        `cd $LOG_DIR/<yyyymmdd>`  
               ▪        Where **<yyyymmdd>** is today's date.
- TYPE:**        `ls -ltr tell_co*`  
               ▪        Displays the current day's **tell\_co** logs from earliest to latest.
- TYPE:**        `tail -f <logname>`  
               ▪        Displays the latest registered messages as the log updates.

### Log Message Format

An entry at the beginning of the log looks like the following:

```
LOG-STATUS: Log file opened on host px2-tbdw at Wed Apr 12 19:45:55 2006
19:45:55.368 doAlivenessTest.c EVENT: waitForReply INTERNAL SUCCESS!!!!...
19:45:56.253 doAlivenessTest.c EVENT: waitForReply EXTERNAL SUCCESS!!!!...
19:45:57.205 tell_co.c EVENT: TELL_CO waitForReply SUCCESS!!!!...
```

The format of the log consists of the following fields:

Time stamp	19:45:57.205
File name	tell_co.c
Message type	EVENT:
Message string	TELL_CO waitForReply SUCCESS!!!!...

#### 8.11.4 listener

The **listener** sets up a socket connection, binds to a local address so that the Client (**CO\_serv**) or **tell\_co** can send to it, and waits for the connection. Upon receipt of data collection request from **tell\_co**, the **listener** forwards information received to the **CO\_serv** process. If any errors were encountered during the data logging, an error message is formulated and passed to the Scheduler for display. In addition, Sutron gauge dialing status information is sent by the **listener** and displayed by the Scheduler.

► **To Access and Read the listener Log**

The **listener** log resides on PX2 in the **\$LOG\_DIR** directory and records messages from the **listener** process. Perform the following commands as user **ldad**:

- TYPE:**        `cd $LOG_DIR/<yyyymmdd>`  
               ▪        Where **<yyyymmdd>** is today's date.



- TYPE:** `ls -ltr listener*`
- Displays the current day's **listener** logs from earliest to latest.
- TYPE:** `tail -f <logname>`
- Displays the latest registered messages as the log updates.

### Log Message Format

An entry at the beginning of this log looks like the following:

```
18:24:10.419 listener.c EVENT: child listener: rcp completed for
SUTRON_coll_sess
18:24:10.422 listener.c EVENT: rcp_cmd_buf=
/awips/ldad/bin/sendLDADnotification.pl V NOTHING px2 1874
18:24:10.596 listener.c PROBLEM: child listener: failed to
sendLDADNotification for SUTRON_coll_sess
```

The format of the log consists of the following fields:

Time stamp	18:24:10:419
File name	listener.c
Message type	EVENT:
Message string	child listener: rcp completed for SUTRON_coll_sess

#### 8.11.5 *CO\_serv*

The Server program (**CO\_serv**) opens up a socket and continually listens for connections from the Client program. When one arrives, a child process is spawned that reads the interprocess message, extracts the name of the “session” file (session file located in **/ldad/data/<id\_coll\_sess>**) for the gauge in question (Sutron), and parses this session file to create two temporary files: a response file and a script file. **CO\_serv** first calculates the starting point of the data to be retrieved and how many data intervals to retrieve from the working configuration file. Using the **process\_expect** executable, **CO\_serv** retrieves the data from the Sutron gauge and stores it in a temporary file. The data are sent to the **sutron** decoder for decoding. If any errors were encountered during the data logging, the error messages are formulated and sent to the user's workstation for display.

#### ► To Access and Read the **CO\_serv** Log

The **CO\_serv** log resides on active LS in the directory **\$LOG\_DIR** and records messages from the **CO\_serv** process. Perform the following commands as user **ldad**:

- TYPE:** `cd $LOG_DIR/<yyyymmdd>`
- Where **<yyyymmdd>** is today's date.

- TYPE:** `ls -ltr CO_serv*`
- Displays the current day's **CO\_serv** log from earliest to latest.
- TYPE:** `tail -f <logname>`
- Displays the latest registered messages as the log updates.

### Log Message Format

An entry at the beginning of this log looks like the following:

```
LOG-STATUS: Log file opened on host ls1-rnk at Wed Apr 12 00:00:17 2006
00:00:17.076 co_serv_main.c EVENT: CO_serv process started
00:05:07.791 co_serv_main.c EVENT: CO_serv received a socket connection at: Apr12 06
00:05:07 GMT
00:05:07.801 co_serv_main.c EVENT: R message Received by CO_serv.....
00:06:36.988 co_serv_main.c EVENT: CO_serv received a socket connection at: Apr12 06
00:06:36 GMT
00:06:36.995 co_serv_main.c EVENT: R message Received by CO_serv.....
00:13:48.283 co_serv_main.c EVENT: CO_serv received a socket connection at: Apr12 06
00:13:48 GMT
00:13:48.291 co_serv_main.c EVENT: R message Received by CO_serv.....
```

The format of the log file consists of the following fields:

```
Time stamp          00:13:48.283
File name           co_serv_main.c
Message type        EVENT:
Message string      CO_serv received a socket connection at: Apr12
                   06 00:13:48 GMT
```

### ► To Access and Read the co.log Log

The **co.log** log resides on the active LS in the **\$LOG\_DIR** directory and records messages from the **CO\_serv** process executing the **sendLDADnotification.pl** script. Perform the following commands as user **ldad**:

- TYPE:** `cd $LOG_DIR/<yyyymmdd>`
- Where **<yyyymmdd>** is today's date.
- TYPE:** `ls -ltr co.log*`
- Displays the current day's **co.log** logs from earliest to latest.
- TYPE:** `tail -f <logname>`
- Displays the latest registered messages as the log updates.

### Log Message Format

An entry at the beginning of this log looks like the following:

```
/awips/ldad/bin/sendLDADnotification.pl:94, socket ok
/awips/ldad/bin/sendLDADnotification.pl:104, bind ok
/awips/ldad/bin/sendLDADnotification.pl:117, connect ok
/awips/ldad/bin/sendLDADnotification.pl:27, Begin sendLDADnotification.pl
```

```
/awips/ldad/bin/sendLDADnotification.pl:38, S, SUTRON_coll_sess 4986 px, px, 15008
/awips/ldad/bin/sendLDADnotification.pl:60, opType = S, msgString = SUTRON_coll_sess 4986
px, host= px, port = 15008
```

### 8.11.6 *process\_expect*

The **process\_expect** executable processes the request for a data transfer. It parses the receive or send session file and invokes **do\_expect** to carry out the transfer by using the script file created by **parse\_session\_file** function as input. It stores the data in the appropriate place and deletes any temporary files used during this session.

#### ► To Access and Read the CO\_serv Log

**process\_expect** writes its messages into the **CO\_serv** log. The log resides on the LS in the directory **\$LOG\_DIR**. Perform the following commands as user **ldad**:

```
TYPE:      cd $LOG_DIR/<yyyymmdd>
               ■      Where <yyyymmdd> is today's date.

TYPE:      ls -ltr CO_serv*
               ■      Displays the current day's logs from earliest to latest.

TYPE:      tail -f <logname>
               ■      Displays the latest registered messages as the log updates.
```

#### Log Message Format

An entry at the beginning of this log looks like the following:

```
process_expect.c EVENT: portLockFile==> /ldad/bin/8elout
20:24:55.303 process_expect.c EVENT: Successfully read data from ADAM4
20:33:33.492 process_expect.c PROBLEM: process_expect: expect session timed
out process_expect.c EVENT: portLockFile==> /ldad/bin/8nlout
```

The format of the log file consists of the following fields:

Time stamp	20:24:55.303
File name	process_expect.c
Message type	EVENT:
Message string	Successfully read data from ADAM4

### 8.11.7 *callSite.ksh*

The **callSite.ksh** script interrogates the datalogger and passes the raw data received from the gauge to the **sutron** decoder for the creation of the CSV and SHEF files.

### 8.11.8 *sutron* decoder

The **sutron** decoder decodes the data and creates a CVS (**.dat**) format file and a SHEF format file using the **SHEFcodes.cfg** configuration file. The files are put in the **/data/Incoming** directory. The number of data intervals collected and the time stamp for the last data interval is written back into the working configuration file to be used by the next data retrieval.

#### ► To Access and Read the *sutron* Log

The **sutron** log resides on the active LS in the directory **\$LOG\_DIR** and records messages from the **sutron** decoder process. Perform the following commands as user **ldad**:

- TYPE:** `cd $LOG_DIR/<yyyymmdd>`  
 ▪ Where **<yyyymmdd>** is today's date.
- TYPE:** `ls -ltr sutron*`  
 ▪ Displays the current day's logs from earliest to latest.
- TYPE:** `tail -f <logname>`  
 ▪ Displays the latest registered messages as the log updates.

#### Log Message Format

An entry at the beginning of this log looks like the following:

```
LOG-STATUS: Log file opened on host ls1-tbdw at Wed Apr 12 20:24:54 2006
20:24:54.815 Sutron.c EVENT: Start decoding Sutron data for ADAM4
20:24:54.95 Sutron.c EVENT: Successfully decoded Sutron data for ADAM4
~
```

The format of the log file consists of the following fields:

Time stamp	20:24:54.951
File name	Sutron.c
Message type	EVENT:
Message string	Successfully decoded Sutron data for ADAM4.

## 8.12 Decode Sutron Data

The **newLDADdataNotification** script checks the LDAD products directory for Sutron files. When a file is available, **newLDADdataNotification** passes the information to the **CO\_serv**, which informs the **listener**. The **listener** moves the file to a **tmp** directory, executes the **preprocessSUTRON.pl** script, and moves the preprocessed file to the **Raw** directory or stores it into the text database, archives, and sends it to the OH's database (SHEF). The **listener** process calls **routerLdadDecoder** to further decode the Sutron file for the creation of the netCDF and SHEF-encoded files. The decoded file is stored and a

notification is sent to the forecaster stating that new data are available. The SHEF-encoded file is forwarded to the NCF for distribution.

### Processes

```

LS      newLDADdataNotification
LS      CO_serv
PX2    listener
PX2    preprocessSUTRON.pl
PX2    CommsRouter LDAD_ROUTER
PX2    DataController LDAD_ROUTER LdadController.config
PX2    routerLdadDecoder
PX2    routerStoreTextEDEX
PX2    routerStoreEDEX
PX2    routerShefEncoderEDEX
PX2    distributeProduct
DX1    notificationServer

```

### Configuration Files (all in /data/fxa/LDAD/data)

LDADinfo.txt	(for listener)
LdadController.config	(for DataController LDAD_ROUTER)
LdadPatterns.txt	(for routerLdadDecoder, routerStoreEDEX, routerShefEncoderEDEX)
SUTRON.desc	(for routerLdadDecoder)
SUTRONStation.txt	(for routerStoreEDEX)

### SUTRON.desc

The **\$LDAD\_DATA/data/SUTRON.desc** file needs no change unless the Sutron datalogger has been modified to collect data with PE codes that are not in the current file. The file is directly coupled with the **SHEFcodes.cfg** file. The sequence of data group entries should be matched with the sequence of PE codes in **SHEFcodes.cfg** file.

Refer to Exhibit 8.12-1 for the Decode Sutron Data data flow diagram.

#### 8.12.1 newLDADdataNotification

The **newLDADdataNotification** process uses the file name and a lookup table (**LDADinfo.txt**) to determine the type of data contained in the file and checks the LDAD products directory (**/data/Incoming**) periodically for Sutron files.

The **newLDADdataNotification** process creates and sends an IPC message to the **CO\_serv** process using **createAndSendIPCmessage**. The message notifies **CO\_serv** that there are Sutron files in the **/data/Incoming** directory.

If **newLDADdataNotification** fails to receive confirmation from **listener** within 5 minutes, or if an **fstat** on the file to transfer fails, the product gets moved to the **/data/ldad/Problem** directory using **moveFileToProblemDir** process. Otherwise, the

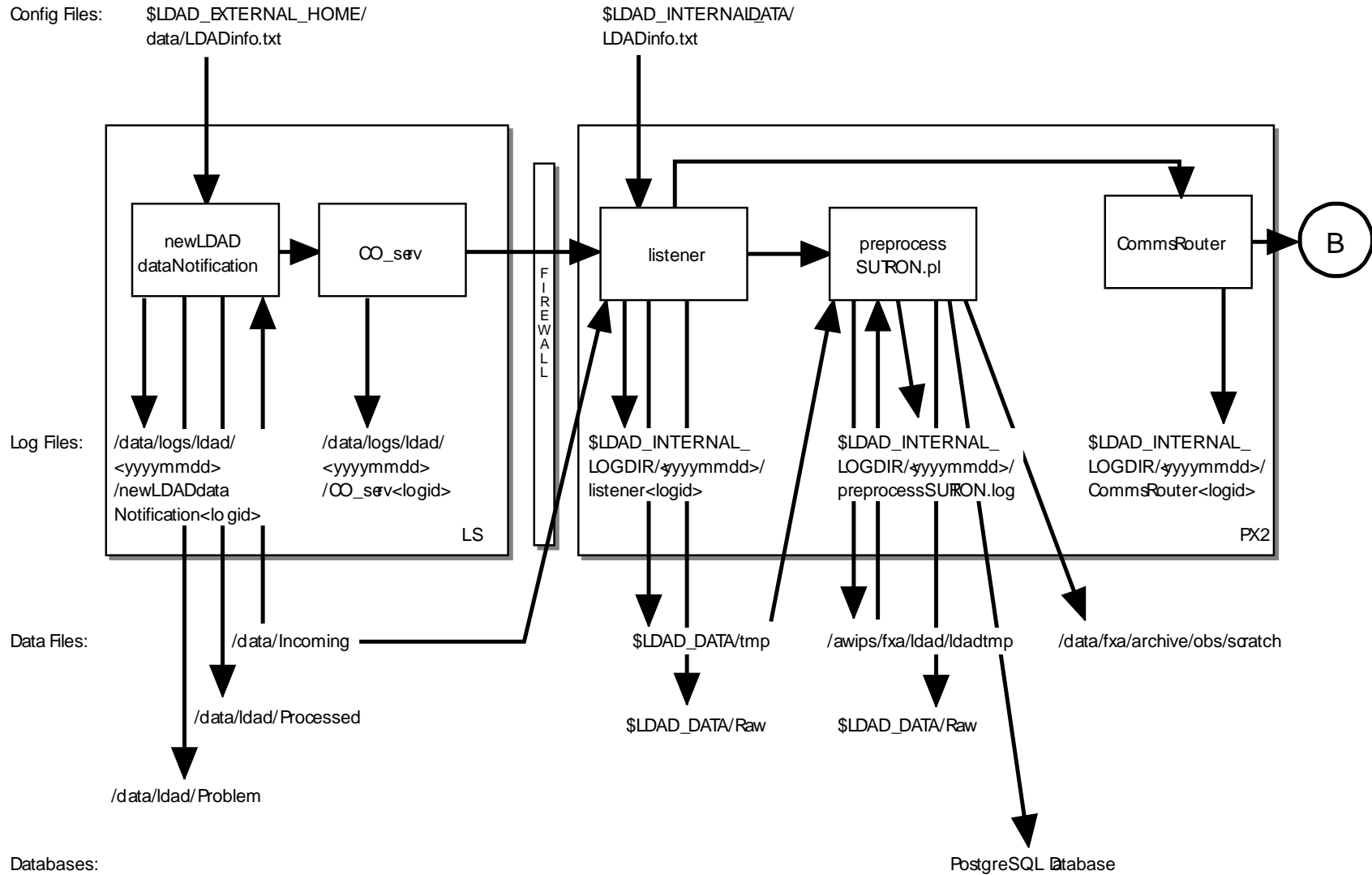

SMM 06/14/06

Exhibit 8.12-1. Decode Sutron Data (for LDAD) (Page 1 of 2)

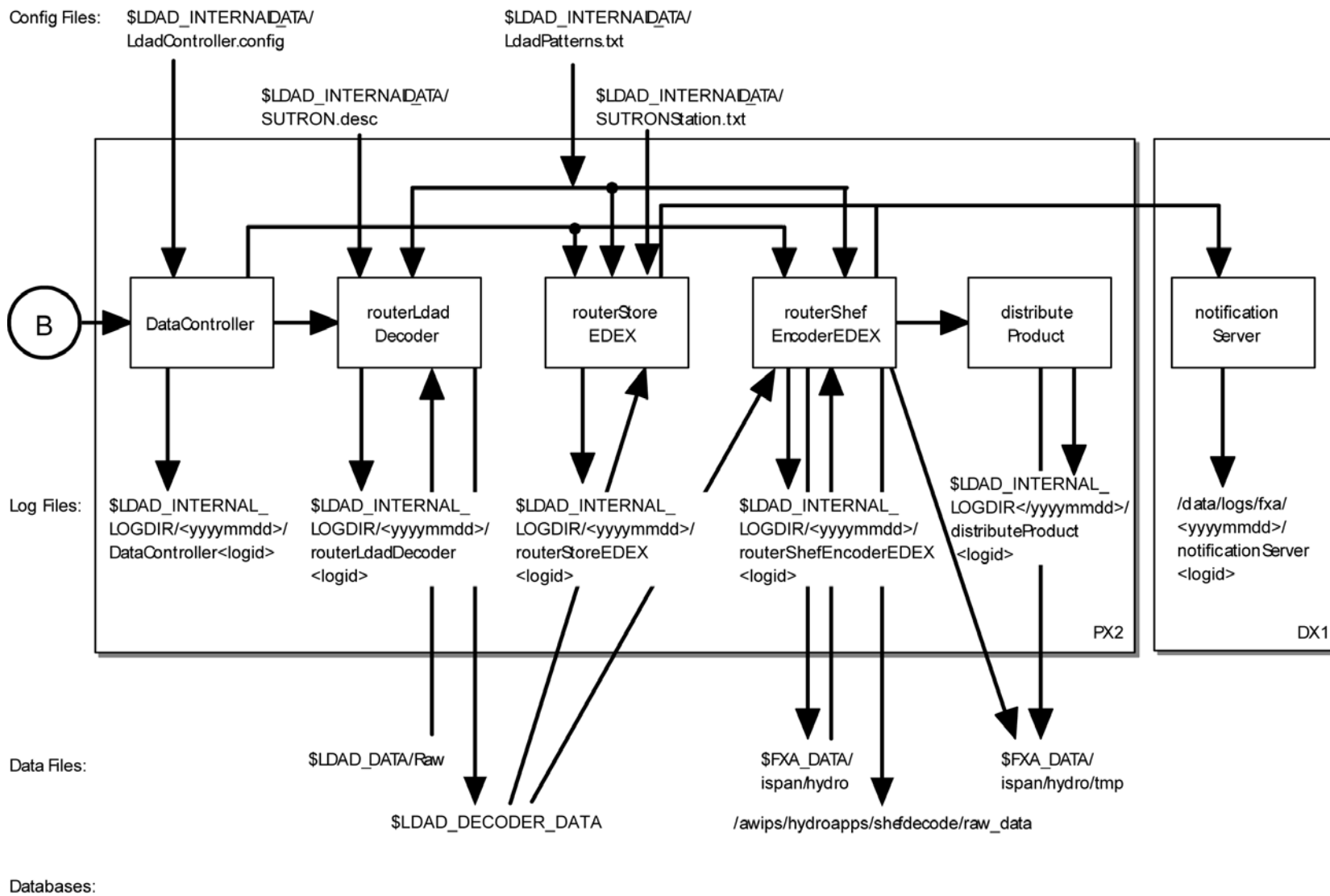

SMM 07/13/10

Exhibit 8.12-1. Decode Sutron Data (for LDAD) (Page 2 of 2)

“processed” files get moved to the `/data/ldad/Processed` directory using the `moveFileToProcessedDir` process.

► **To Access and Read the newLDADdataNotification Log**

The `newLDADdataNotification` log resides on the active LS in the `$LOG_DIR` directory and records messages from the `newLDADdataNotification` process. Perform the following commands as user `ldad`:

- TYPE:** `cd $LOG_DIR/<yyyymmdd>`
- Where `<yyyymmdd>` is today’s date.
- TYPE:** `ls -ltr newLDADdataNotification*`
- Displays the current day’s `newLDADdataNotification` logs from earliest to latest.
- TYPE:** `tail -f <logname>`
- Displays the latest registered messages as the log updates.

**Log Message Format**

An entry at the beginning of this log looks like the following:

```
20:25:24.174 newLDADdataNotification.c EVENT: Processing :
/data/Incoming/SUTRONADAM4302024.dat.999203094
20:25:24.760 newLDADdataNotification.c EVENT: waitForReply SUCCESS on
/data/Incoming/SUTRONADAM4302024.dat.999203094
```

The format of the log file consists of the following fields:

```
Time stamp          20:25:24.760
File name           newLDADdataNotification.c
Message type        EVENT:
Message string      waitForReply SUCCESS on
                   /data/Incoming/SUTRONADAM4302024.dat.999203094
```

**8.12.1 CO\_serv**

`CO_serv` initially sets up a socket (TCP/IP) and waits for connections. The notification received from `newLDADdataNotification` is passed across the firewall to the `listener` process on the internal side on the `PX2`.

► **To Access and Read the CO\_serv Log**

The `CO_serv` log resides on the active LS in the directory `$LOG_DIR` and records messages from the `CO_serv` process. Perform the following commands as user `ldad`:

- TYPE:** `cd $LOG_DIR/<yyyymmdd>`
- Where `<yyyymmdd>` is today’s date.



- TYPE:** `ls -ltr CO_serv*`
- Displays the current day's **CO\_serv** logs from earliest to latest.
- TYPE:** `tail -f <logname>`
- Displays the latest registered messages as the log updates.

### Log Message Format

An entry at the beginning of this log looks like the following:

```
LOG-STATUS: Log file opened on host ls1-rnk at Wed Apr 12 00:00:17 2006
00:00:17.076 co_serv_main.c EVENT: CO_serv process started
00:05:07.791 co_serv_main.c EVENT: CO_serv received a socket connection at: Apr12 06 00:05:07 GMT
00:05:07.801 co_serv_main.c EVENT: R message Received by CO_serv.....
00:06:36.988 co_serv_main.c EVENT: CO_serv received a socket connection at: Apr12 06 00:06:36 GMT
00:06:36.995 co_serv_main.c EVENT: R message Received by CO_serv.....
00:13:48.283 co_serv_main.c EVENT: CO_serv received a socket connection at: Apr12 06 00:13:48 GMT
00:13:48.291 co_serv_main.c EVENT: R message Received by CO_serv.....
```

The format of the log file consists of the following fields:

Time stamp	00:00:17.076
File name	co_serv_main.c
Message type	EVENT:
Message string	CO_serv process started

### 8.12.2 listener

The **listener** reads the **LDADinfo.txt** config file, sets up a socket, binds its local address so that the Client (**CO\_serv**) can send to it, and waits for the connection from the Client process. When the notification is received, the **listener** retrieves the Sutron file from the **/data/Incoming** directory on the LS and copies it to the **\$LDAD\_DATA/tmp** directory on the PX inside the firewall. If the file requires no preprocessing, **listener** moves the data file directly to the Raw directory. The **listener** sends a verification when done.

The **listener** executes the **\$FXA\_HOME/ldad/bin/preprocessSUTRON.pl** script to preprocess the Sutron data files. The **listener** receives the fully qualified data file, the hostname used by notification routine, the port number of the process requiring notification upon completion of the preprocessing, and other necessary information about the data file format from **CO\_serv**. Finally, the **listener** sends notification to the **CommsRouter LDAD\_ROUTER** that a product has been preprocessed.

#### ► To Access and Read the listener Log

The **listener** log resides on PX2 in the directory **\$LOG\_DIR** and records messages from the **listener** process. Perform the following commands as user **ldad**:

- TYPE:** `cd $LOG_DIR/<yyyymmdd>`
- Where **<yyyymmdd>** is today's date.

- TYPE:** `ls -ltr listener*`
- Displays the current day's **listener** logs from earliest to latest.
- TYPE:** `tail -f <logname>`
- Displays the latest registered messages as the log updates.

### Log Message Format

An entry at the beginning of this log looks like the following:

```
18:27:29.743 listener.c EVENT: do_G_Msg: rcp completed for
SUTRONADAM4181823.dat.1069179781.1069180027
18:27:29.759 listener.c EVENT: do_G_Msg: Preprocessor Command Line =
</awips/ldad/bin/preprocessSUTRON.pl
/data/fxa/LDAD/tmp/SUTRONADAM4181823.dat.1069179781.1069180027 px 15009>
```

The format of the log consists of the following fields:

Time stamp	18:27:29.743
File name	listener.c
Message type	EVENT:
Message string	do_G_Msg: rcp completed for SUTRONADAM4181823.dat.1069179781.1069180027

### 8.12.3 *preprocessSUTRON.pl*

The **preprocessSUTRON.pl** script copies the files from the **\$LDAD\_DATA/tmp** directory to the **/awips/fxa/ldad/ldadtmp** directory. There, it reformats the Sutron data files, appends the **abstime** string to the file names, and stores the preprocessed file (**.dat**) in the **\$LDAD\_DATA/Raw** directory and the SHEF file into the Postgres text database, archives it, and sends it to the OH database.

#### ► To Access and Read the **preprocessSUTRON** Log

The **preprocessSUTRON** log resides on PX2 in the directory **\$LOG\_DIR** and records messages from the **preprocessSUTRON.pl** process. Perform the following commands as user **ldad**:

- TYPE:** `cd $LOG_DIR/<yyyymmdd>`
- Where **<yyyymmdd>** is today's date.
- TYPE:** `ls -ltr preprocessSUTRON*`
- Displays the current day's **preprocessSUTRON** logs from earliest to latest.
- TYPE:** `tail -f <logname>`
- Displays the latest registered messages as the log updates.

## Log Message Format

An entry at the beginning of this log looks like the following:

```
<><><><><><><><><><><><><><><><><><><><><><><><><><><><><><><>
<>   New Activity Log Started Wed Apr 12 20:25:24 UTC 2006
<><><><><><><><><><><><><><><><><><><><><><><><><><><><><><><><>
Start preprocessing
/data/fxa/LDAD/tmp/SUTRONADAM4302024.dat.999203094.999203124
ARGV[0]: /data/fxa/LDAD/tmp/SUTRONADAM4302024.dat.999203094.999203124
ARGV[1]: px
ARGV[2]: 15009
moveFile(): move /data/fxa/LDAD/tmp/SUTRONADAM4302024.dat.999203094.999203124
to /data/fxa/LDAD/Raw/SUTRONADAM4302024.dat.999203094.999203124
moveFile(): /data/fxa/LDAD/tmp/SUTRONADAM4302024.dat.999203094.999203124 moved
successfully.
1
    Successfully moved Sutron CSV format file from /tmp directory into /raw
directory
    Notified LDAD_ROUTER new Sutron data file for decoding
```

The format of the log file consists of the following fields:

File name	moveFile():
Message string	/data/fxa/LDAD/tmp/SUTRONADAM4302024.dat.999203094.999203124 to /data/fxa/LDAD/Raw/SUTRONADAM4302024.dat.999203094.999203124

### 8.12.4 LDAD\_ROUTER

The **LDAD\_ROUTER** (registered **LDAD CommsRouter**) is responsible for transporting data notifications from the data acquisition processes to the data controller processes. The main function of the **LDAD\_ROUTER** is message passing; it does no data processing. The router provides a known location where the data acquisition processes can send data messages.

#### ▶ To Access and Read the CommsRouter Log

The **LDAD\_ROUTER CommsRouter** log resides on PX2 in a time-stamped directory under **\$LOG\_DIR**. Perform the following commands as user **ldad**:

- ```
TYPE:      cd $LOG_DIR/<yyyymmdd>
```
- Where **<yyyymmdd>** is today's date.
- ```
TYPE:      ps -wef |grep ldad
```
- Displays the **ldad** processes. Notice the PID of the **CommsRouter** process that is owned by user **ldad**.
- ```
TYPE:      ls -ltr Comms*
```
- Displays the latest logs.

**NOTE:** The **CommsRouter** log containing the PID of the **LDAD\_ROUTER** process is the **LDAD\_ROUTER CommsRouter** log.

**TYPE:** tail -f <logname>  
 ■ Displays the log as it updates.

### Log Message Format

An entry in the log should look like the following:

```
20:25:25.662 CommsReceiver.C EVENT: NCF_ENTRY DSMsg:
SUTRONADAM4302024.dat.999203094.999203124 1 41
20:25:25.885 CommsReceiver.C EVENT: NCF_ENTRY DSMsg: 999203124.SUTRONADAM4302024.decoded
1 58
20:25:26.023 CommsReceiver.C EVENT: NCF_ENTRY DSMsg:
SUTRONADAM4302024.dat.999203094.999203124 1 41
```

The log file consists of the following fields:

|                |                                                              |
|----------------|--------------------------------------------------------------|
| Time stamp     | 20:25:25.885                                                 |
| File name      | CommsReceiver.C                                              |
| Message type   | EVENT:                                                       |
| Message string | NCF_ENTRY DSMsg:<br>999203124.SUTRONADAM4302024.decoded 1 58 |

The **LDAD\_ROUTER CommsRouter** is started automatically at system reboot time or can be started manually. The **CommsRouter** runs continuously, exiting only when killed by the restart program.

### 8.12.5 DataController

The **DataController** is responsible for creating the decoder and storage processes (as child processes), restarting them if they exit, routing appropriate messages to them, and queuing incoming data messages until the decoder and storage processes are ready. As data messages are stored in the queue, the size of the processes grows.

The **DataController's** main program creates a **DataRouting** manager object when it first starts up and invokes a member function to start the **routerLdadDecoder**, **routerStoreEDEX**, and **routerShefEncoderEDEX** processes by reading and executing the **LdadController.config** file. The file resides on the **\$LDAD\_INTERNAL\_DATA** directory and contains the names of the above processes to start/restart, a restart flag, and **eof** designators to alert the Data Routing Manager that there are no more processes listed in the file.

The **LDAD\_ROUTER** sends product-received notifications to the **DataController**. When the processes first start up, they send messages containing their IPC addresses and process numbers to the **DataController**. The processes send the **DataController** a data request message and a ready-to-receive data message. In response, the **DataController** stores the processes' ID information and data requests, and sends a message to the requesting processes (if a message is available). The **DataController** waits to receive

another ready message from the processes before sending any more data messages. The **DataController** queues any messages it receives from the **LDAD\_ROUTER** until the processes send another ready message.

### ► To Access and Read the DataController Log

The **DataController** log resides on PX2 in a time-stamped directory under **\$LOG\_DIR**. Perform the following commands as user **ldad**:

- TYPE:** `cd $LOG_DIR/<yyyymmdd>`
- Where **<yyyymmdd>** is today's date.
- TYPE:** `ls -ltr DataController*`
- Displays the latest log for the **DataController LDAD\_ROUTER** process.
- TYPE:** `tail -f <logname>`
- Displays the current log as it updates with the latest messages.

### Log Message Format

An entry in the log should look similar to the following:

```
20:25:25.664 CommsReceiver.C EVENT: NCF_ENTRY CDMsg:
SUTRONADAM4302024.dat.999203094.999203124 1 41
20:25:25.887 CommsReceiver.C EVENT: NCF_ENTRY CDMsg: 999203124.SUTRONADAM4302024.decoded
1 58
20:25:26.025 CommsReceiver.C EVENT: NCF_ENTRY CDMsg:
SUTRONADAM4302024.dat.999203094.999203124 1 41
```

The log file consists of the following fields:

```
Time stamp          20:25:25.887
File name           CommsReceiver.C
Message type        EVENT:
Message string      NCF_ENTRY CDMsg:
                   999203124.SUTRONADAM4302024.decoded 1 58
```

### 8.12.6 routerLdadDecoder

The **routerLdadDecoder** process is spawned by the **DataController** as specified in the **LdadController.config** file. The **routerLdadDecoder** process sends a data request to the **DataController** for the Sutron products it wishes to receive by specifying product header patterns of interest. On receipt of a notification from the **DataController** that a product of interest has arrived, the **routerLdadDecoder** reads the directory containing the raw files, **\$LDAD\_DATA/Raw**.

The **routerLdadDecoder** process reads each file and stores them via serialized data files to the **\$LDAD\_DECODED\_DATA** directory. The serialized file name is sent back

through the **LDAD\_ROUTER** to notify registered LDAD storage processes of the arrival of each LDAD decoded product.

► **To Access and Read the routerLdadDecoder Log**

The **routerLdadDecoder** log resides on PX2 in a time-stamped directory under **\$LOG\_DIR**. Perform the following commands as user **ldad**:

- TYPE:** `cd $LOG_DIR/<yyyymmdd>`
- Where **<yyyymmdd>** is today's date.
- TYPE:** `ls -ltr routerLdadDecoder*`
- Displays the latest log for the **routerLdadDecoder** process.
- TYPE:** `tail -f <logname>`
- Displays the current log as it updates with the latest messages.

**Log Message Format**

An entry in the log should look like the following:

```
20:25:25.698 LdadRoutines.C EVENT: Processing [1/1] =
SUTRONADAM4302024.dat.999203094.999203124
20:25:25.884 LdadRoutines.C EVENT: LdadRoutines::pingLdadRouter(), '$LDAD_DECODED_DATA/
999203124.SUTRONADAM4302024.decoded', sent to LDAD_ROUTER
```

The log file consists of the following fields:

|                |                                                                                                                 |
|----------------|-----------------------------------------------------------------------------------------------------------------|
| Time stamp     | 20:25:25.884                                                                                                    |
| File name      | LdadRoutines.C                                                                                                  |
| Message type   | EVENT:                                                                                                          |
| Message string | LdadRoutines::pingLdadRouter(), '\$LDAD_DECODED_DATA/ 999203124.SUTRONADAM4302024.decoded', sent to LDAD_ROUTER |

**8.12.7 routerStoreEDEX**

The **routerStoreEDEX** process is spawned by the **DataController** as specified in the **LdadController.config** file. The **routerStoreEDEX** process sends a data request to the **DataController** for serialized decoded Campbell files in netCDF format. When notified by the **DataController** that a product of interest has arrived, **routerStoreNetcdf** reads the directory containing the files, **\$LDAD\_DECODED\_DATA**. The **routerStoreEDEX** process stores the files in the **/data\_store/ldad** directory in the XML format and sends a notification to the **EDEX**.

► **To Access and Read the routerStoreNetcdf Log:**

The **routerStoreNetcdf** log resides on PX2 in a time-stamped directory under **\$LOG\_DIR**. Perform the following commands as user **ldad**:

- TYPE:** `cd $LOG_DIR/<yyyymmdd>`
- Where **<yyyymmdd>** is today's date.
- TYPE:** `ls -ltr routerStoreNetcdf*`
- Displays the latest logs for the **routerStoreNetcdf** process.
- TYPE:** `tail -f <logname>`
- Displays the log as it updates with the latest messages.

### Log Message Format

An entry in the log should look like the following:

```
20:25:25.890 routerStoreNetcdf.C EVENT: routerStoreEDEX.C,
putData(/data/fxa/LDAD/decoded/999203124.SUTRONADAM4302024.decoded)
20:25:26.356 LdadEDEXStorage.C PROBLEM: var: riverFlow (float) = '2.09702'. Units conversion
from ft3/s to m3/s failed.
20:25:26.410 routerStoreEDEX.C EVENT: routerStoreEDEX
/data/fxa/LDAD/decoded/999203124.SUTRONADAM4302024.decoded completed
20:30:26.752 routerStoreEDEX.C EVENT: routerStoreEDEX.C,
putData(/data/fxa/LDAD/decoded/999203424.RAWS.decoded)
20:30:29.613 LdadStorage.C EVENT: LdadStorage::separatePatterns () <[-99., -99.00 ]> from
<-99. -99.00>
20:30:31.560 routerStoreEDEX.C EVENT: routerStoreEDEX
/data/fxa/LDAD/decoded/999203424.RAWS.decoded completed
```

The log file consists of the following fields:

|                |                                                                                               |
|----------------|-----------------------------------------------------------------------------------------------|
| Time stamp     | 20:25:25.890                                                                                  |
| File name      | routerStoreEDEX.C                                                                             |
| Message type   | EVENT:                                                                                        |
| Message string | routerStoreEDEX.C,<br>putData(/data/fxa/LDAD/decoded/999203124.SUTRONA<br>DAM4302024.decoded) |

### 8.12.8 routerShefEncoderEDEX

The **routerShefEncoderEDEX** process is spawned by the **DataController** as specified in the **LdadController.config** file. The **routerShefEncoderEDEX** process sends a data request to the **DataController** for serialized decoded files. On receipt of a notification from the **DataController** that a product of interest has arrived, the **routerShefEncoderEDEX** reads the directory containing the files, **\$LDAD\_DECODED\_DATA**. The files there are SHEF-encoded and moved to the **/data\_store/ldad** directory. The **routerShefEncoderEDEX** process sends a notification to the **EDEX**. Once the SHEF-encoded data file is stored in the **/data\_store/ldad** directory, the **routerShefEncoderEDEX** saves a copy of the file in the **/tmp** directory and calls **distributeProduct** process to send the file to the NCF over the WAN.

► **To Access and Read the routerShefEncoderEDEX Log**

The **routerShefEncoderEDEX** log resides on PX2 in a time-stamped directory under **\$LOG\_DIR**. Perform the following commands as user **ldad**:

- TYPE:** `cd $LOG_DIR/<yyyymmdd>`
- Where **<yyyymmdd>** is today's date.
- TYPE:** `ls -rtal routerShefEncoderEDEX*`
- Displays the latest logs for the **routerShefEncoderEDX** process.
- TYPE:** `tail -f <logname>`
- Displays the current log as it is updated with the latest messages.

### Log Message Format

An entry in the log should look like the following:

```
20:25:25.891 routerShefEncoderEDEX.C EVENT: routerShefEncoderEDEX
</data/fxa/LDAD/decoded/999203124.SUTRONADAM4302024.decoded>
20:25:26.316 ShefStorage.C EVENT: TZ= GMT
20:25:26.396 checkWmoHeader.C EVENT: checkWmoHeader()
20:25:26.397 checkWmoHeader.C EVENT: checkWmoHeader() : data contains a WMO header.
20:25:26.397 SHEF_format.C EVENT: SHEF_format::sendToProductWan -> data contains a WMO
header.
  Creating a dummy file (zero bytes).
20:25:26.721 SHEF_format.C EVENT: SHEF_format::sendToProductWan ->
system(distributeProduct -a DEFAULTINCF -e /data/fxa/ispan/hydro/temp/A_format.999203126
KSTORRZLDA /data/fxa/ispan/hydro/temp/A_format.999203126);
20:25:26.722 SHEF_format.C EVENT: shef data has sent to WAN successfully!
```

The log file consists of the following fields:

```
Time stamp          20:25:25.891
File name           routerShefEncoderEDEX.C
Message type        EVENT:
Message string      routerShefEncoderEDEX
```

```
</data/fxa/LDAD/decoded/999203124.SUTRONADAM4302024.decoded>
```

### 8.12.9 *distributeProduct*

The **distributeProduct** process creates a product message and submits it for distribution across the AWIPS WAN to the addressed sites. The **distributeProduct** process first prepares the product by creating the WAN communications header and prepending the header to a temporary copy of the product. Distribution requests, enclosing the temporary copy of the product, are subsequently made through the **msg\_send** utility program.



► **To Access and Read the distributeProduct Log**

The **distributeProduct** log resides on PX2 in a time-stamped directory under **\$LOG\_DIR**. Perform the following commands as user **ldad**:

**TYPE:**        `cd $LOG_DIR/<yyyymmdd>`  
                   ▪        Where **<yyyymmdd>** is today's date.

**TYPE:**        `ls -ltr distributeProduct*`  
                   ▪        Displays the latest logs for the **distributeProduct** process.

**TYPE:**        `tail -f <logname>`  
                   ▪        Displays the current log as it updates with the latest messages.

### Log Message Format

An entry in the log should look like the following:

```
LOG-STATUS: Log file opened on host px2-tbdw at Wed April 12 19:30:59 2006
19:30:59.690 MHSProduct.C PROBLEM: Product
(/data/fxa/ispan/hydro/temp/A_format.973020657) is empty.
19:30:59.853 MHSProduct.C EVENT: Sending attachments
(/data/fxa/ispan/hydro/temp/A_format.973020657)
only. Attachments are assumed to contain correct communications header.
19:31:02.504 MHSProduct.C EVENT: Product request (KSTORRZLDA) was successfully
submitted to the MHS request server for distribution.
      Message Attributes:
          Request ID: TBDW-25380
          To: DEFAULTNCF
          Priority: 0
          Type: Routine
          Subject:
          Handling Action: 0
19:31:02.518 MHSProduct.C EVENT: TBDW-25380
~
```

The log file consists of the following fields:

```
Time stamp            19:31:02.504
File name             MHSProduct.C
Message type          EVENT:
Message string        Product request (KSTORRZLDA) was successfully
submitted to the MHS request server for
distribution.
Message Attributes:
Request ID: TBDW-25380
To: DEFAULTNCF
Priority: 0
Type: Routine
Subject:
Handling Action: 0
```

### 8.12.10 *notificationServer*

The **notificationServer** provides information to its display clients that a new version of a display product has become available. Data acquisition processes send data notification messages to the **notificationServer**, which acts as a bridge between the data acquisition and workstation display components of AWIPS.

#### ► **To Access and Read the notificationServer Log**

The **notificationServer** log resides on the DX1 in the directory **\$LOG\_DIR**. This log records messages from the **notificationServer** process. Perform the following commands as user fxa:

- TYPE:**        `cd $LOG_DIR/<yyyymmdd>`  
                   ▪        Where **<yyyymmdd>** is today's date.
- TYPE:**        `ls -ltr notificationServer*`  
                   ▪        Displays the current day's **notificationServer** logs from earliest to latest.
- TYPE:**        `tail -f <logname>`  
                   ▪        Displays the latest registered messages as the log updates.

#### **Log Message Format**

An entry at the beginning of the log looks like the following:

```
00:00:21.263 DepictableInventory.C EVENT: In purgeALittle, updating the time
cache if files have been purged

00:00:21.377 DepictUpdateMgr.C DIAG: Currently there are no pending depictable
notifications.

00:00:21.377 NotificationServer.C DIAG:

---Notification Server Statistics---

Size of client list (depict keys): 13

Processes per depictable (min/avg/max): 1/1.07692/2

Total data notifications processed since last stat: 0

Maximum number of pending notifications since last stat: 0

Total depict notifications sent since last stat: 0

Total depict notifications failed to match inventories: 0

Total depict notifications failed because of IPC: 0

Process ID of anonymous target: 19701
```

Host: lx5-tbw3

Port number: 44435

NORMAL PRIORITY CONNECTION

Connection created: Jun 06 12 20:06:03 GMT. Initiated by connecting process.

Last time this connection was used: Jun 06 12 20:06:03 GMT

No messages have been sent since last stat report.

No messages have been received since last stat report.

-----  
No connections have used any threads thus far.

00:00:21.263 DepictableInventory.C EVENT: In purgeALittle, updating the time cache if files have been purged

00:00:21.377 DepictUpdateMgr.C DIAG: Currently there are no pending depictable notifications.

00:00:21.377 NotificationServer.C DIAG:

---Notification Server Statistics---

Size of client list (depict keys): 13

Processes per depictable (min/avg/max): 1/1.07692/2

Total data notifications processed since last stat: 0

Maximum number of pending notifications since last stat: 0

Total depict notifications sent since last stat: 0

Total depict notifications failed to match inventories: 0

Total depict notifications failed because of IPC: 0

CACHED INVENTORY INFO

Num entries: 12

Total Size in bytes: 2544

Time spent retrieving non cached inventories: 0

20 biggest inventories:

00:00:21.377 Connection.C DIAG:

IPC STATISTICS for NOTIFICATION\_SERVER from Jul 11 12 00:00:21 GMT to Jul 11 12 00:00:21 GMT

No TCP/IP socket connections have been terminated since the last stat report.

4 TCP/IP socket connections are currently active.

Process ID of anonymous target: 27720

Host: px2-tbw3

Port number: 54203

NORMAL PRIORITY CONNECTION

Connection created: May 30 12 17:18:40 GMT. Initiated by connecting process.

Last time this connection was used: Jul 10 12 23:55:42 GMT

No messages have been sent since last stat report.

No messages have been received since last stat report.

### 8.13 *Acquire and Decode Comma Separated Variable Mesonet Data*

The **newLDADdataNotification** script checks the LDAD products directory for Mesonet files. When a file is available, it passes the information to the **CO\_serv**, which informs the **listener**. The **listener** executes the **preProcessLDAD.pl** script and calls **routerLdadDecoder** to decode the file. The decoded file is stored and a notification is sent to the user stating that new data are available.

#### Processes

```
LS    newLDADdataNotification
LS    CO_serv
PX2   listener
PX2   preProcessLDAD.pl
PX2   preprocessmesonet.pl
PX2   CommsRouter LDAD_ROUTER
PX2   DataController LDAD_ROUTER LdadController.config
PX2   routerLdadDecoder
PX2   routerStoreEDEX
```

#### Configuration Files (all in /data/fxa/LDAD/data)

```
LDADinfo.txt           (for listener)
*Station.txt          (files with station metadata for routerStoreEDEX)
*.desc                (files for routerLdadDecoder)
LdadController.config (for DataController LDAD_ROUTER)
LdadPatterns.txt      (for routerLdadDecoder, routerStoreEDEX)
```

Refer to Exhibit 8.13-1 for the Acquire and Decode Comma Separated Variable Mesonet data flow diagram.

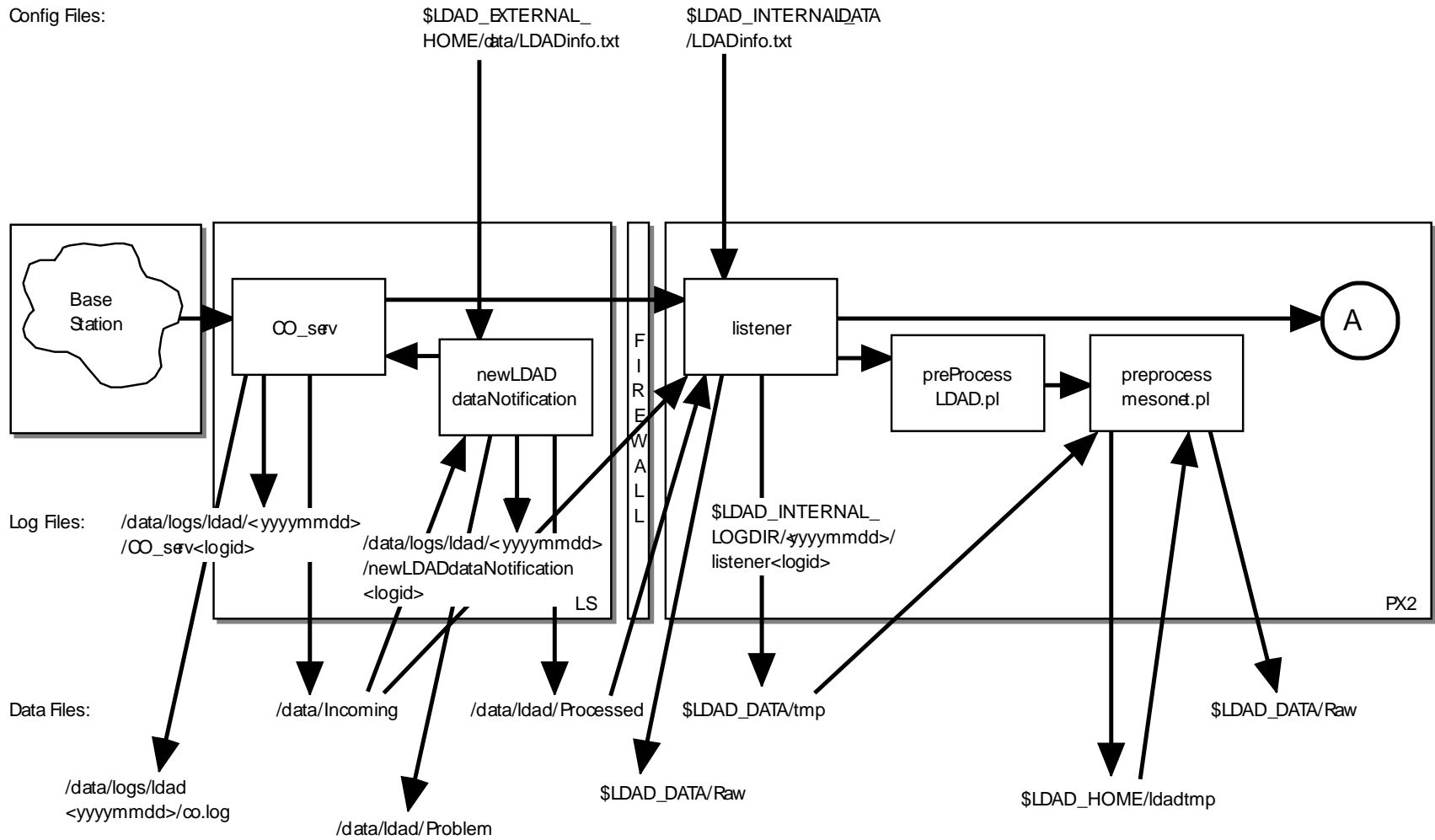

SMM 06/14/06

Exhibit 8.13-1. Acquire and Decode Comma Separated Variable Mesonet Data (for LDAD) (Page 1 of 2)

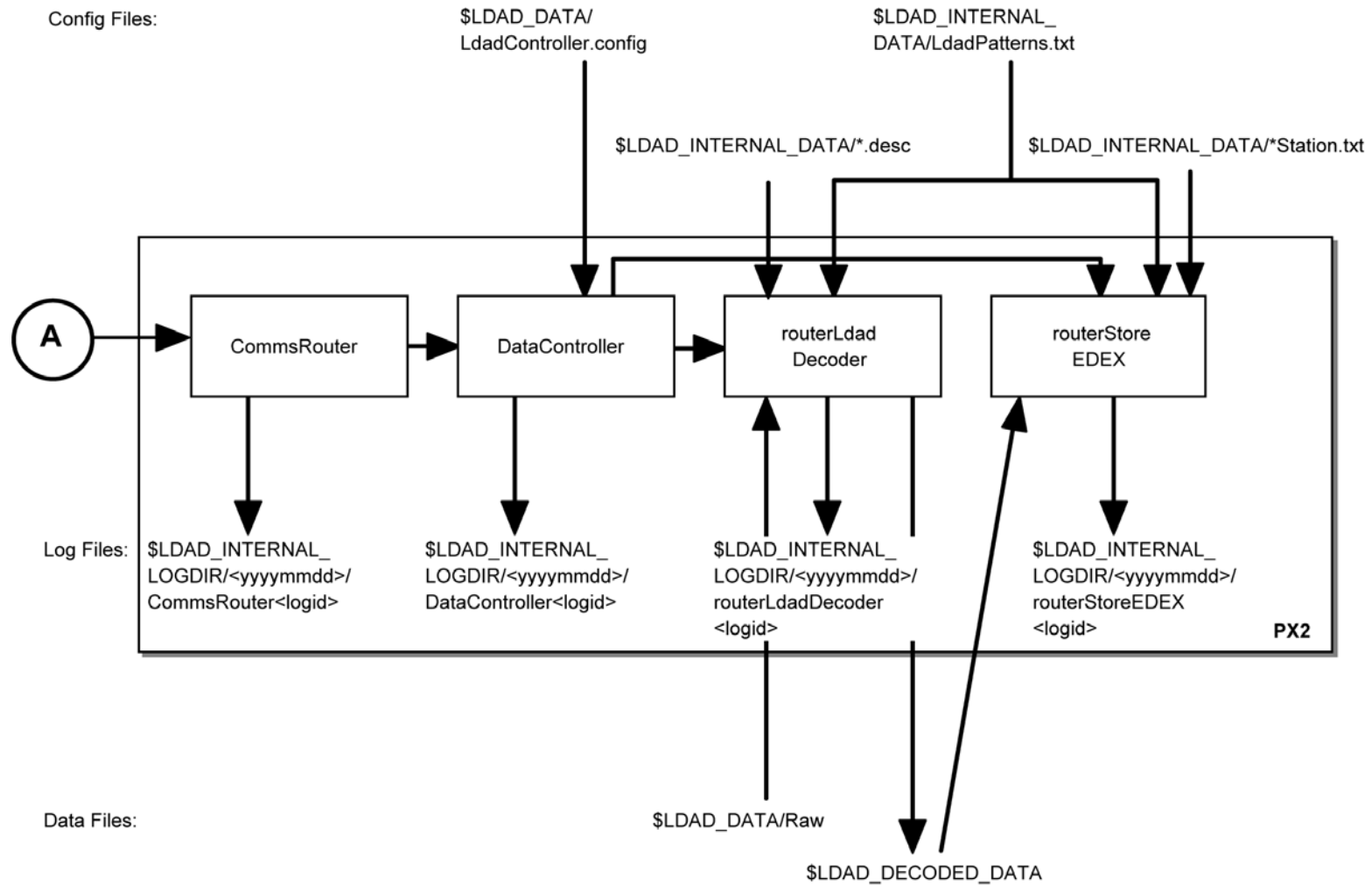

SMM 07/13/10

Exhibit 8.13-1. Acquire and Decode Comma Separated Variable Mesonet Data (for LDAD) (Page 2 of 2)

### 8.13.1 CO\_serv

The **CO\_serv** process calls **process\_cu** to process the request for a “cu” transfer. The **process\_cu** executable parses the receive session file and invokes **cu** to transfer the file. The file is stored in the **/data/Incoming** directory. The notification received from **newLDADdataNotification** is passed across the firewall to the **listener** process on the internal side on the PX.

#### ► To Access and Read the CO\_serv Log

The **CO\_serv** log resides on the active LS in the **\$LOG\_DIR** directory. This log records messages from the **CO\_serv** process. Perform the following commands as user **ldad**:

- TYPE:** `cd $LOG_DIR/<yyyymmdd>`
- Where **<yyyymmdd>** is today’s date.
- TYPE:** `ls -ltr CO_serv*`
- Displays the current day’s **CO\_serv** logs from earliest to latest.
- TYPE:** `tail -f <logname>`
- Displays the latest registered messages as the log updates.

#### Log Message Format

An entry at the beginning of this log looks like the following:

```
LOG-STATUS: Log file opened on host ls1-rnk at Wed APR 12 00:00:17 2006
00:00:17.076 co_serv_main.c EVENT: CO_serv process started
00:05:07.791 co_serv_main.c EVENT: CO_serv received a socket connection at: Apr12 06
00:05:07 GMT
00:05:07.801 co_serv_main.c EVENT: R message Received by CO_serv....
00:06:36.988 co_serv_main.c EVENT: CO_serv received a socket connection at: Apr12 06
00:06:36 GMT
00:06:36.995 co_serv_main.c EVENT: R message Received by CO_serv....
00:13:48.283 co_serv_main.c EVENT: CO_serv received a socket connection at: Apr12 06
00:13:48 GMT
00:13:48.291 co_serv_main.c EVENT: R message Received by CO_serv....
```

The log file consists of the following fields:

|                |                         |
|----------------|-------------------------|
| Time stamp     | 00:00:17.076            |
| File name      | co_serv_main.c          |
| Message type   | EVENT:                  |
| Message string | CO_serv process started |

► **To Access and Read the co.log Log**

The **co.log** log resides on PX2 in the **\$LOG\_DIR** directory and records messages from the **CO\_serv** process executing the **sendLDADnotification.pl** script. Perform the following commands as user **ldad**:

- TYPE:**        `cd $LOG_DIR/<yyyymmdd>`
- `-Where <yyyymmdd> is today's date.`
- TYPE:**        `ls -ltr co.log*`
- `Displays the current day's co.log logs from earliest to latest.`
- TYPE:**        `tail -f <logname>`
- `Displays the latest registered messages as the log updates.`

### Log Message Format

An entry at the beginning of this log looks like the following:

```
/awips/ldad/bin/sendLDADnotification.pl:94, socket ok
/awips/ldad/bin/sendLDADnotification.pl:104, bind ok
/awips/ldad/bin/sendLDADnotification.pl:117, connect ok
/awips/ldad/bin/sendLDADnotification.pl:27, Begin sendLDADnotification.pl
/awips/ldad/bin/sendLDADnotification.pl:38, O, 4296 px2-tbdw 4296, px, 15008
/awips/ldad/bin/sendLDADnotification.pl:60, opType = O, msgString = 4296 px2-tbdw 4296,
host = px, port = 15008
/awips/ldad/bin/sendLDADnotification.pl:94, socket ok
/awips/ldad/bin/sendLDADnotification.pl:104, bind ok
/awips/ldad/bin/sendLDADnotification.pl:117, connect ok
/awips/ldad/bin/sendLDADnotification.pl:27, Begin sendLDADnotification.pl
/awips/ldad/bin/sendLDADnotification.pl:38, S, CAMPBELL_coll_sess 4300 px, px, 15008
/awips/ldad/bin/sendLDADnotification.pl:60, opType = S, msgString = CAMPBELL_coll_sess
4300 px, host =px, port = 15008
/awips/ldad/bin/sendLDADnotification.pl:94, socket ok
/awips/ldad/bin/sendLDADnotification.pl:104, bind ok
/awips/ldad/bin/sendLDADnotification.pl:117, connect ok
/awips/ldad/bin/sendLDADnotification.pl:27, Begin sendLDADnotification.pl
/awips/ldad/bin/sendLDADnotification.pl:38, O, 15008 px2-tbdw 4398, px, 15008
/awips/ldad/bin/sendLDADnotification.pl:60, opType = O, msgString = 15008 px2-tbdw 4398,
host = px, port = 15008
```

### 8.13.2 newLDADdataNotification

The **newLDADdataNotification** process uses the file's name and a lookup table (**LDADinfo.txt**) to determine the type of data contained in the file and checks the LDAD products directory (**/data/Incoming**) periodically for Mesonet files.

The **newLDADdataNotification** process creates and sends an IPC message to the **CO\_serv** process using **createAndSendIPCmessage**. The message notifies **CO\_serv** that there are Mesonet files in the **/data/Incoming** directory.

If **newLDADdataNotification** fails to receive confirmation from **listener** within 5 minutes or if an **fstat** on the file to transfer fails, the product gets moved to the **/data/ldad/Problem** directory using **moveFileToProblemDir** process. Otherwise, the



“processed” file is moved to the `/data/ldad/Processed` directory using the `moveFileToProcessDir` process.

► **To Access and Read the newLDADdataNotification Log**

The `newLDADdataNotification` log resides on the active LS in the `$LOG_DIR` directory and records messages from the `newLDADdataNotification` process. Perform the following commands as user `ldad`:

```
TYPE:      cd $LOG_DIR/<yyyymmdd>
              ■      Where <yyyymmdd> is today’s date.
```

```
TYPE:      ls -ltr newLDADdataNotification*
              ■      Displays the current day’s newLDADdataNotification
                      logs from earliest to latest.
```

```
TYPE:      tail -f <logname>
              Displays the latest registered messages as the log updates.
```

### Log Message Format

An entry at the beginning of this log looks like the following:

```
LOG-STATUS: Log file opened on host ls1-tbdw at Wed Apr 12 00:00:56 2006
00:00:56.825 newLDADdataNotification.c EVENT: newLDADdataNotification process started
00:00:56.829 newLDADdataNotification.c EVENT: Reading /data/Incoming/ every 20 seconds
00:00:56.834 newLDADdataNotification.c EVENT: Processing : /data/Incoming/RAWS.dat
00:09:37.413 newLDADdataNotification.c EVENT: Processing : /data/Incoming/alert_wx.dat
00:09:38.155 newLDADdataNotification.c EVENT: waitForReply SUCCESS on
/data/Incoming/alert_wx.dat
```

The format of the log file consists of the following fields:

```
Time stamp      00:09:38.155
File name       newLDADdataNotification.c
Message type    EVENT:
Message string  waitForReply SUCCESS on
                /data/Incoming/alert_wx.dat
```

### 8.13.3 listener

The `listener` reads the `LDADinfo.txt` config file, sets up a socket, binds its local address so that the Client (`CO_serv`) can send to it, and waits for the connection from the Client process. When the notification is received, the `listener` retrieves the Mesonet file from the `/data/Incoming` directory on the active LS and copies it to the `$LDAD_DATA/tmp` directory on the PX2. If the file requires no preprocessing, `listener` moves the data file directly to the `Raw` directory. The `listener` sends verification when finished.

The `listener` executes the `preProcessLDAD.pl` script to preprocess the Mesonet data files. The `listener` receives the fully qualified data file, the hostname used by notification

routine, the port number of the process requiring notification upon completion of the preprocessing, and other necessary information about the Mesonet data file format from **CO\_serv**. Finally, the listener sends notification to the LDAD **CommsRouter**, **LDAD\_ROUTER**, that a product has been preprocessed.

### ► To Access and Read the listener Log

The **listener** log resides on PX2 in the directory **\$LOG\_DIR**. This log records messages from the **listener** process. Perform the following commands as user **ldad**:

**TYPE:** `cd $LOG_DIR/<yyyymmdd>`

- Where **<yyyymmdd>** is today's date.

**TYPE:** `ls -ltr listener*`

- Displays the current day's **listener** logs from earliest to latest.

**TYPE:** `tail -f <logname>`

- Displays the latest registered messages as the log updates.

### Log Message Format

An entry at the beginning of this log looks like the following:

```
00:09:39.213 listener.c EVENT: do_G_Msg: rcp completed for
alert_wx.dat.974333378
00:09:39.263 listener.c EVENT: do_G_Msg: Preprocessor Command Line =
</awips/ldad/bin/preProcessLDAD.pl /data/fxa/LDAD/tmp/alert_wx.dat.97433378 px
15009>
```

The format of the log consists of the following fields:

|                |                                                                                                                                   |
|----------------|-----------------------------------------------------------------------------------------------------------------------------------|
| Time stamp     | 00:09:39.263                                                                                                                      |
| File name      | listener.c                                                                                                                        |
| Message type   | EVENT:                                                                                                                            |
| Message string | do_G_Msg: Preprocessor Command Line =<br></awips/ldad/bin/preProcessLDAD.pl<br>/data/fxa/LDAD/tmp/alert_wx.dat.97433378 px 15009> |

#### 8.13.4 *preProcessLDAD.pl*

The **preProcessLDAD.pl** script preprocesses UDFCD ALERT (**\_R5**, **\_WL**, **\_WX**), **Cdot**, **IFLOWS**, and **LARC** data report files for the LDAD decoder. It initializes file input/output and values to the existing variables, calls the appropriate preprocessor (**preprocessmesonet.pl** for Mesonet data), and cleans up.

### 8.13.5 *preprocessmesonet.pl*

The **preprocessmesonet.pl** script copies the file from the **\$LDAD\_DATA/tmp** directory to the **\$LDAD\_HOME/ldadtmp** directory. There, it reformats the Mesonet data file, appends the **abstime** string to the file name, and stores the preprocessed file in the **\$LDAD\_DATA/Raw** directory.

### 8.13.6 *LDAD\_ROUTER*

The **LDAD\_ROUTER** (registered LDAD **CommsRouter**) is responsible for transporting data notifications from the data acquisition processes to the data controller processes. The main function of the **LDAD\_ROUTER** is message passing; it does not do any data processing. The router provides a known location where the data acquisition processes can send data messages.

#### ► To Access and Read the CommsRouter Log

The **LDAD\_ROUTER CommsRouter** log resides on PX2 in a time-stamped directory under **\$LOG\_DIR**. Perform the following commands as user **ldad**:

**TYPE:** `cd $LOG_DIR/<yyyymmdd>`  
 ▪ Where **<yyyymmdd>** is today's date.

**TYPE:** `ps -wef |grep ldad`  
 ▪ Displays the **ldad** processes. Notice the PID of the **CommsRouter** process that is owned by user **ldad**.

**TYPE:** `ls -ltr Comms*`  
 ▪ Displays the latest logs.

**NOTE:** The **CommsRouter** log containing the PID of the **LDAD\_ROUTER** process is the **LDAD\_ROUTER CommsRouter** log.

**TYPE:** `tail -f <logname>`  
 ▪ Displays the log as it updates.

#### Log Message Format

An entry in the log should look like the following:

```
LOG-STATUS: Log file opened on host px2-tbdw at Wed April 12 00:00:16 2006
00:00:15.851 CommsReceiver.C EVENT: NCF_ENTRY CRMsg Pattern:
.*\..decoded|^[0-9.]*[^\m]([^\s]([^\a]([^\s]([^\_]([^\
q]([^\c]))))).*\..decoded$|(.*\.[0-9]+)|(^[0-9]*\..msas_qc\..*)$|.*\/Text\/.*\.[0-
9]+
00:01:02.726 CommsReceiver.C EVENT: NCF_ENTRY DSMsg:
/data/fxa/LDAD/Raw/RAWS.dat.974332858 1 37
00:01:02.729 CommsReceiver.C EVENT: NCF_ENTRY DSMsg: RAWS.dat.974332858 1 18
```

```

00:01:05.511 CommsReceiver.C EVENT: NCF_ENTRY DSMsg: 974332858.RAWS.decoded 1
45
00:03:38.783 CommsReceiver.C EVENT: NCF_ENTRY DSMsg:
/data/fxa/LDAD/Raw/974332800.03.msas_qc.RAWS 1 44
00:03:39.361 CommsReceiver.C EVENT: NCF_ENTRY DSMsg:
RAWS.974332800.03.msas_qc.decoded 1 56
00:09:40.979 CommsReceiver.C EVENT: NCF_ENTRY DSMsg:
/data/fxa/LDAD/Text/alert_wx.dat.974333378 1 42
00:09:41.462 CommsReceiver.C EVENT: NCF_ENTRY DSMsg:
974333378.alert_wx.decoded 1 49

```

The log consists of the following fields:

|                |                                                  |
|----------------|--------------------------------------------------|
| Time stamp     | 00:09:41.462                                     |
| File name      | CommsReceiver.C                                  |
| Message type   | EVENT:                                           |
| Message string | NCF_ENTRY DSMsg: 974333378.alert_wx.decoded 1 49 |

The **LDAD\_ROUTER CommsRouter** is started automatically at system reboot time or can be started manually. The **CommsRouter** runs continuously, exiting only when killed by the restart program.

### 8.13.7 DataController

The **DataController** is responsible for creating the decoder and storage processes (as child processes), restarting them if they exit, routing appropriate messages to them, and queuing incoming data messages until the decoder and storage processes are ready. As data messages are stored in the queue, the size of the processes grows.

The **DataController's** main program creates a **DataRouting** manager object when it first starts up and invokes a member function to start the **routerLdadDecoder**, and **routerStoreEDEX**, processes by reading and executing the **LdadController.config** file. The file resides on the **\$LDAD\_INTERNAL\_DATA** directory and contains the names of these decoders to start/restart, a restart flag, and **eof** designators to alert the Data Routing Manager that there are no more processes listed in the file.

The **LDAD\_ROUTER** sends product-received notifications to the **DataController**. When the processes first start up, they send messages containing their IPC addresses and process numbers to the **DataController**. The processes send the **DataController** a data request message and a ready-to-receive data message. In response, the **DataController** stores the processes' ID information and data requests, and sends a message to the requesting processes (if a message is available). The **DataController** waits to receive another ready message from the processes before sending any more data messages. The **DataController** queues any messages it receives from the **LDAD\_ROUTER** until the processes send another ready message.

#### ► To Access and Read the DataController Log

The **DataController** log resides on PX2 in a time-stamped directory under **\$LOG\_DIR**. Perform the following commands as user **ldad**:

- TYPE:** `cd $LOG_DIR/<yyyymmdd>`
- Where **<yyyymmdd>** is today's date
- TYPE:** `ps -wef |grep ldad`
- Displays the **ldad** processes. Note the PID for the **DataController**.
- TYPE:** `ls -rtal DataController*`
- Displays the latest logs for the **DataController**
- TYPE:** `tail -f <logname>`
- Displays the log as it updates with the latest messages

### Log Message Format

An entry in the log should look similar to the following:

```
LOG-STATUS: Log file opened on host px2-tbdw at Wed April 12 00:00:14 2006
00:00:13.815 DataCaptReceiver.C EVENT: DataReqMsg: pattern =
(.*\.[0-9]+)|(^[0-9]*\msas_qc\.*)$
00:00:14.390 DataCaptReceiver.C EVENT: DataReqMsg: pattern =
^[0-9.]*[^\m]([^\s]([^\a]([^\s]([^\_]([^\q]([^\c]))))))\.*\decoded$
00:00:14.716 DataCaptReceiver.C EVENT: DataReqMsg: pattern =
.*Text/.*\.[0-9]+
00:00:15.701 DataCaptReceiver.C EVENT: DataReqMsg: pattern = .*\.decoded
00:01:03.102 CommsReceiver.C EVENT: NCF_ENTRY CDMsg:
/data/fxa/LDAD/Text/RAWS.dat.974332858 1 38
00:01:03.120 CommsReceiver.C EVENT: NCF_ENTRY CDMsg:
/data/fxa/LDAD/Raw/RAWS.dat.974332858 1 37
00:01:03.121 CommsReceiver.C EVENT: NCF_ENTRY CDMsg: RAWS.dat.974332858 1 18
00:01:05.514 CommsReceiver.C EVENT: NCF_ENTRY CDMsg: 974332858.RAWS.decoded 1
45
00:03:38.795 CommsReceiver.C EVENT: NCF_ENTRY CDMsg:
/data/fxa/LDAD/Raw/974332800.03.msas_qc.RAWS 1 44
00:03:39.365 CommsReceiver.C EVENT: NCF_ENTRY CDMsg:
RAWS.974332800.03.msas_qc.decoded 1 56
00:09:41.086 CommsReceiver.C EVENT: NCF_ENTRY CDMsg:
/data/fxa/LDAD/Text/alert_wx.dat.974333378 1 42
00:09:41.464 CommsReceiver.C EVENT: NCF_ENTRY CDMsg:
974333378.alert_wx.decoded 1 49
00:09:41.485 CommsReceiver.C EVENT: NCF_ENTRY CDMsg:
/data/fxa/LDAD/Raw/alert_wx.dat.974333378 1 41
00:09:43.935 CommsReceiver.C EVENT: NCF_ENTRY CDMsg: alert_wx.dat.974333378 1
22
```

The log file consists of the following fields:

|                |                                              |
|----------------|----------------------------------------------|
| Time stamp     | 00:09:43.935                                 |
| File name      | CommsReceiver.C                              |
| Message        | EVENT:                                       |
| Message string | NCF_ENTRY CDMsg: alert_wx.dat.974333378 1 22 |

### 8.13.8 *routerLdadDecoder*

The **routerLdadDecoder** process is spawned by the **DataController** as specified in the **LdadController.config** file. The **routerLdadDecoder** process sends a data request to the **DataController** requesting Mesonet products it wishes to receive by specifying product header patterns of interest. On receipt of a notification from the **DataController** that a Mesonet product of interest has arrived, the **routerLdadDecoder** reads the directory containing the raw files, **\$LDAD\_DATA/Raw**.

The description file (\*.desc) is read by the **routerLdadDecoder**, which uses the information to evaluate each line of data by checking for the meteorological variable, the incoming data's units of measure, and the storage units of measure.

The **.desc** format follows.

| #netcdf Var Name | data type | input units      | stored units |
|------------------|-----------|------------------|--------------|
| stationId        | STRING    | STRING           | STRING       |
| observationTime  | DATE_TIME | DATE_TIME_STRING | ABSTIME      |
| temperature      | FLOAT     | F                | Kelvin       |
| dewpoint         | FLOAT     | F                | Kelvin       |
| precipAccum      | FLOAT     | mm               | m            |
| windSpeed        | FLOAT     | mph              | m/s          |
| windGust         | FLOAT     | mph              | m/s          |
| windDir          | INT       | degreeN          | degreeN      |
| windDirMax       | FLOAT     | degreeN          | degreeN      |
| visibility       | FLOAT     | ft               | m            |

The **routerLdadDecoder** process reads each file and stores them via serialized data files to the **\$LDAD\_DECODED\_DATA** directory. The serialized file name is sent back through the **LDAD\_ROUTER** to notify registered LDAD storage processes of the arrival of each LDAD decoded product.

#### ► To Access and Read the **routerLdadDecoder** Log

The **routerLdadDecoder** log resides on PX2 in a time-stamped directory under **\$LOG\_DIR**. Perform the following commands as user **ldad**:

- TYPE:** `cd $LOG_DIR/<yyyymmdd>`
- Where **<yyyymmdd>** is today's date.
- TYPE:** `ls -rtal routerLdadDecoder*`
- Displays the latest logs for the **routerLdadDecoder**.
- TYPE:** `tail -f <logname>`
- Displays the log as it updates with the latest messages.

#### Log Message Format

An entry in the log should look like the following:

```

LOG-STATUS: Log file opened on host px2-tbdw at Wed April 12 00:01:04 2006
00:01:03.580 DataCaptReceiver.C USE: ProdLen 3800:01:04.520 LdadRoutines.C
EVENT: Processing [1/1] = RAWs.dat.974332858
00:01:05.510 LdadRoutines.C EVENT: LdadRoutines::pingLdadRouter(),
'$LDAD_DECODED_DATA/ 974332858.RAWs.decoded', sent to LDAD_ROUTER

00:01:05.517 DataCaptReceiver.C USE: ProdLen 37
00:01:05.537 DataCaptReceiver.C USE: ProdLen 18
00:03:38.808 DataCaptReceiver.C USE: ProdLen 44
00:03:38.836 LdadRoutines.C EVENT: Processing [1/1] =
974332800.03.msas_qc.RAWs
00:03:39.370 LdadRoutines.C EVENT: LdadRoutines::pingLdadRouter(),
'$LDAD_DECODED_DATA/ RAWs.974332800.03.msas_qc.decoded', sent to LDAD_ROUTER

00:03:39.374 DataCaptReceiver.C USE: ProdLen 56
00:09:41.224 DataCaptReceiver.C USE: ProdLen 42
00:09:41.267 LdadRoutines.C EVENT: Processing [1/1] = alert_wx.dat.974333378
00:09:41.467 LdadRoutines.C EVENT: LdadRoutines::pingLdadRouter(),
'$LDAD_DECODED_DATA/ 974333378.alert_wx.decoded', sent to LDAD_ROUTER

```

The log consists of the following fields:

|                |                                                                                                              |
|----------------|--------------------------------------------------------------------------------------------------------------|
| Time stamp     | 00:09:41.467                                                                                                 |
| File name      | LdadRoutines.C                                                                                               |
| Message type   | EVENT:                                                                                                       |
| Message string | LdadRoutines::pingLdadRouter(),<br>'\$LDAD_DECODED_DATA/<br>974333378.alert_wx.decoded,' sent to LDAD_ROUTER |

### 8.13.9 routerStoreEDEX

The **routerStoreEDEX** process is spawned by the **DataController** as specified in the **LdadController.config** file. The **routerStoreEDEX** process sends a data request to the **DataController** requesting serialized decoded Mesonet files. On receipt of a notification from the **DataController** that a product of interest has arrived, **routerStoreEDEX** reads the directory containing the files, **\$LDAD\_DECODED\_DATA**. The **\*Station.txt** file is used by **routerStoreEDEX** to pull station metadata such as latitude, longitude, and elevation.

The **.txt** format follows.

```

ProviderId|AFOS(HB5)|StationName|StationElevation|Latitude|Longitude|localTZ
|LocationDesc|
StationType|NumberOfInstruments|NumberOfLevels|Maint/CalibSchedules|
SiteDesc|

```

|                     |                                     |
|---------------------|-------------------------------------|
| <b>Provider ID</b>  | Data provider station ID            |
| <b>AFOS ID</b>      | Station AFOS (or Handbook V) ID     |
| <b>Station Name</b> | Text name of station                |
| <b>Elevation</b>    | Elevation of station                |
| <b>Latitude</b>     | Latitude of station                 |
| <b>Longitude</b>    | Longitude of station                |
| <b>local TZ</b>     | Local time zone (i.e., log MST7MDT) |

|                                          |                                                                                                         |
|------------------------------------------|---------------------------------------------------------------------------------------------------------|
| <b>Location Desc</b>                     | Location of station (Text)                                                                              |
| <b>Station Type</b>                      | Type of station (i.e., logtower, surface, floating platform)                                            |
| <b>Number of Instruments</b>             | The number of reporting instruments for the station                                                     |
| <b>Number of Levels</b>                  | Number of reporting levels for the data (level information should be provided in the instrument table.) |
| <b>Maintenance/Calibration Schedules</b> | Frequency of maintenance/calibration                                                                    |
| <b>Site Description</b>                  | A text description of the site surrounding                                                              |

The **routerStoreEDEX** process stores the files in the **SLAD\_DATA/mesonet/netCDF** directory and sends a notification to the **notificationServer**.

### ► To Access and Read the routerStoreEDEX Log

The **routerStoreEDEX** log resides on PX2 in a time-stamped directory under **\$LOG\_DIR**. Perform the following commands as user **ldad**:

- TYPE:** `cd $LOG_DIR/<yyyymmdd>`
- Where **<yyyymmdd>** is today's date.
- TYPE:** `ps -wef |grep ldad`
- Displays the **routerStoreEDEX** process along with all other **ldad**-owned processes.
- TYPE:** `ls -rtal routerStoreEDEX*`
- Displays the latest logs for the **routerStoreEDEX** process.
- TYPE:** `tail -f <logname>`
- Displays the log as it updates with the latest messages.

### Log Message Format

```
00:01:06.020 DataCaptReceiver.C USE: ProdLen 45
00:01:06.797 routerStoreEDEX.C EVENT: routerStoreEDEX.C,
putData(/data/fxa/LDAD/decoded/974332858.RAWS.decoded)
00:01:16.599 LdadStorage.C EVENT: LdadStorage::separatePatterns () <[-99.,
-99.00 ]> from <-99. -99.00>
00:01:19.301 routerStoreEDEX.C EVENT: routerStoreEDEX
/data/fxa/LDAD/decoded/974332858.RAWS.decoded completed
00:03:39.370 DataCaptReceiver.C USE: ProdLen 5600:03:39.391 routerStoreEDEX.C
EVENT: routerStoreEDEX.C,
putData(/data/fxa/LDAD/decoded/RAWS.974332800.03.msas_qc.decoded)
00:03:39.839 LdadStorage.C PROBLEM: Unable to find netCDF data key for ,
msas_qc.RAWS
00:03:39.922 routerStoreEDEX.C EVENT: routerStoreEDEX
/data/fxa/LDAD/decoded/RAWS.974332800.03.msas_qc.decoded completed
00:09:41.544 DataCaptReceiver.C USE: ProdLen 49
```



```
00:09:41.560 routerStoreEDEX.C EVENT: routerStoreEDEX.C,
putData(/data/fxa/LDAD/decoded/974333378.alert_wx.decoded)
```

The log consists of the following fields:

```
Time stamp      00:09:41.560
File name       routerStoreEDEX.C
Message type    EVENT:
Message string  routerStoreEDEX.C,
                putData(/data/fxa/LDAD/decoded/974333378.alert_w
                x.decoded)
```

#### 8.14 Acquire and Process ASOS/MicroART Data (for LDAD)

The processing and data flow for the ASOS and micro-Automatic Radio theodolite System (MicroART) products are identical; therefore, their description is combined in this section.

The **suaReceiver** process starts the data acquisition process for the ASOS/MicroART system. Data acquisition occurs through a pseudo-terminal device configured by the Xyplex Terminal Server. The **newLDADdataNotification** script checks the LDAD directory for ASOS/MicroART files. When a file is available, the **newLDADdataNotification** script passes the information to the **suaReceiver**, which informs **CO\_serv**, which passes the message to the **listener**, which executes the **preprocessSUA.pl** script. The **preprocessSUA.pl** script copies the file to a tmp directory and stores it into the text database via the **textdb** command line interface. When the file is successfully stored in the database, a notification is sent to the text **notificationServer**. Finally, the data are routed to the NCF via the WAN.

#### Processes

```
LS    suaReceiver
LS    newLDADdataNotification
LS    CO_serv
PX2   listener
PX2   preprocessSUA.pl
PX2   distributeProduct
```

#### Configuration Files (all in /data/fxa/LDAD/data)

```
suaCategories.txt      (for suaReceiver)
LDADinfo.txt           (for listener)
rcv_action2codes.txt   (for distributeProduct)
siteCommission.txt     (for distributeProduct)
```

Refer to Exhibit 8.14-1 for the Acquire and Process ASOS/MicroART data flow diagram.

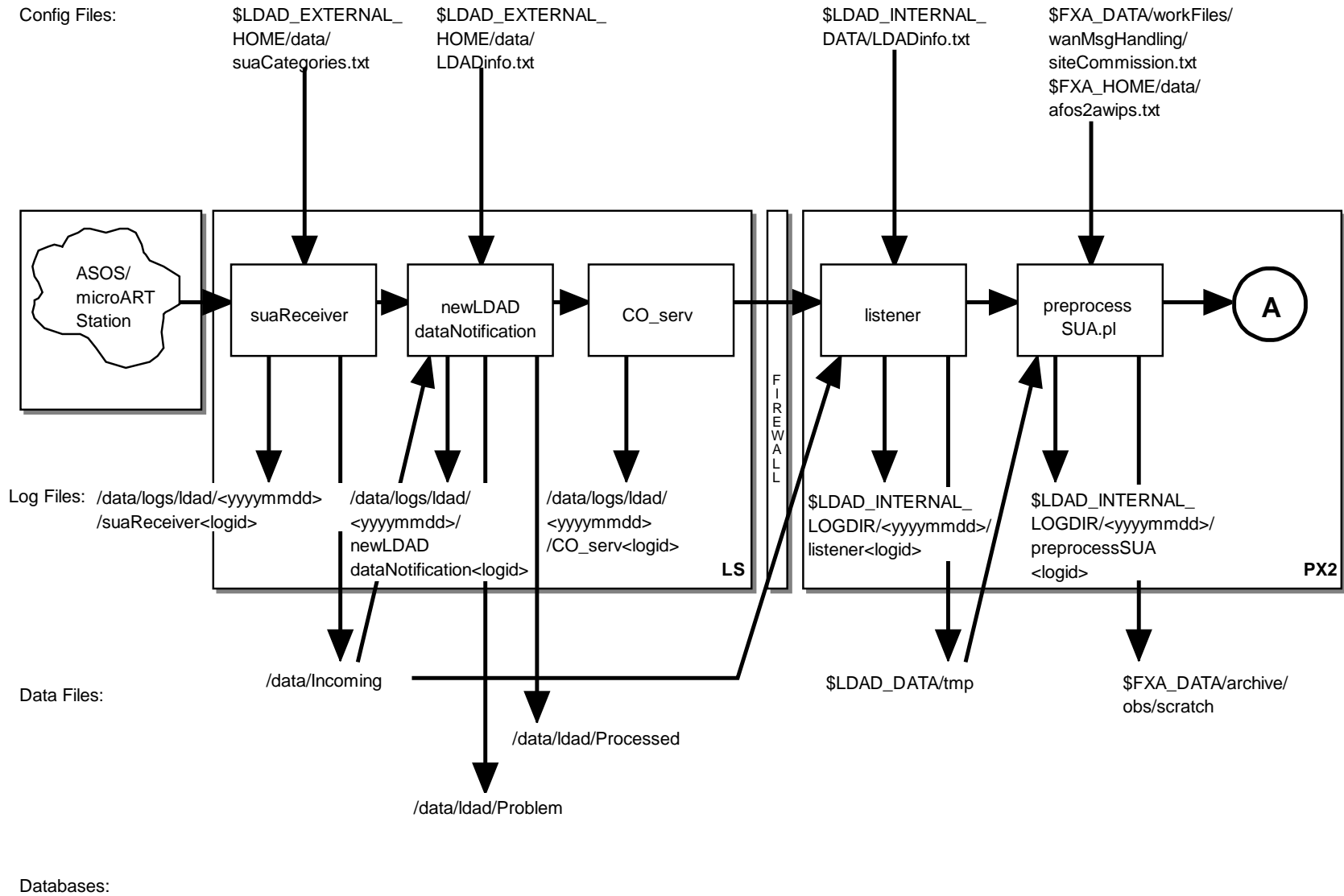

SMM 06/14/06

**Exhibit 8.14-1. Acquire and Process ASOS/MicroART Data (for LDAD) (Page 1 of 2)**

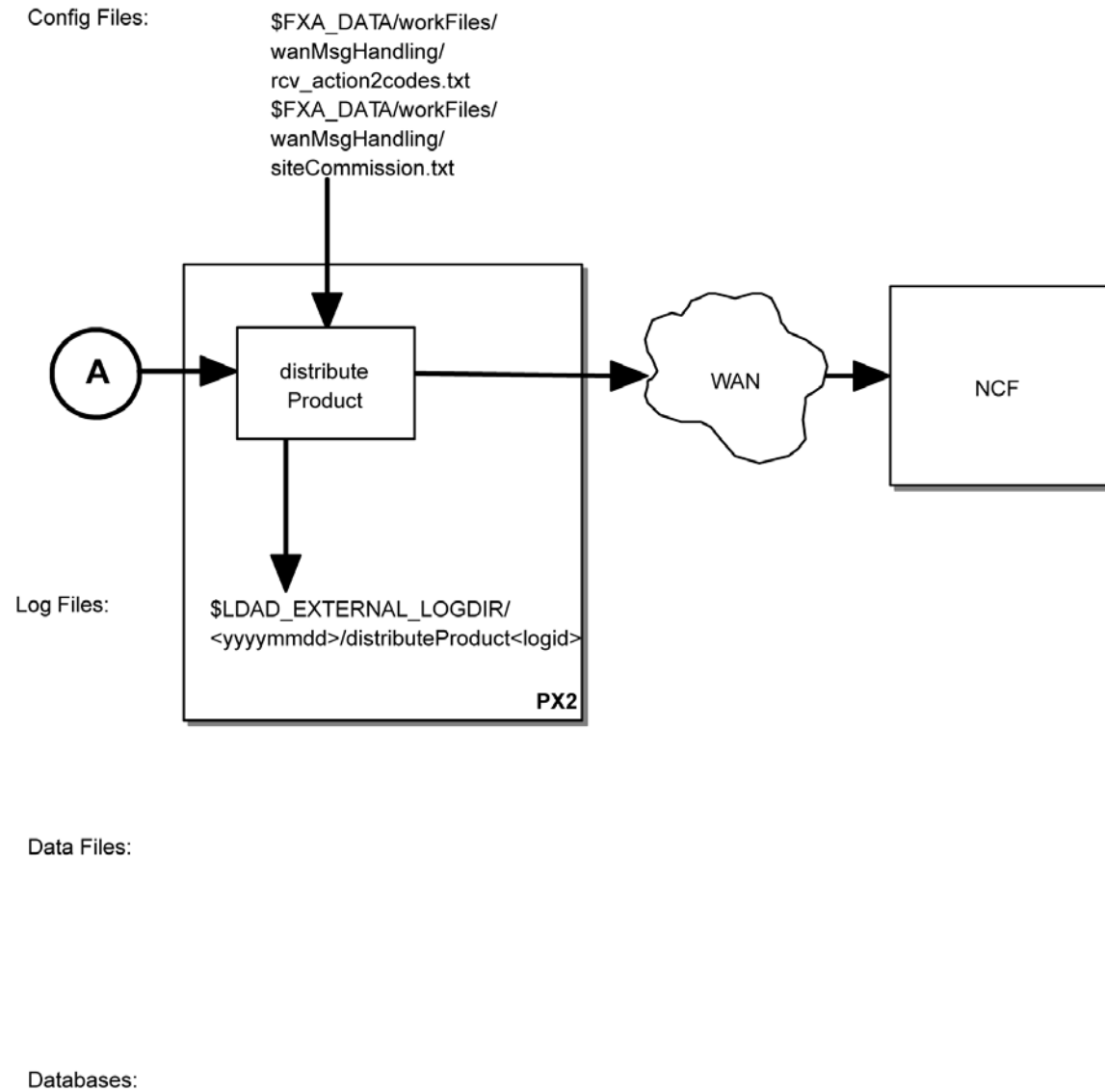

SMM 07/13/10

Exhibit 8.14-1. Acquire and Process ASOS/MicroART Data (for LDAD) (Page 2 of 2)

### 8.14.1 suaReceiver

The Surface and Upper Air Receiver, **suaReceiver**, acquires observational data from the ASOS and MicroART stations. The **suaReceiver** process supports asynchronous connections from the ASOS/MicroART systems through a dial-in modem. The **suaReceiver** process initially sets up a TCP/IP socket and waits for connections. When a connection is made and a message arrives, the **suaReceiver** process parses the information contained in the message buffer. Using the parsed information, the **suaReceiver** process connects to the ASOS/MicroART station. Once a message is received and confirmed as a valid product message, the product is stored in the **/data/Incoming** directory.

#### ► To Access and Read the suaReceiver Log

The **suaReceiver** log resides on the active LS in a time-stamped directory under **\$LOG\_DIR**. The log file contains event messages recording product receipt and transmission, message format errors, and timeout errors in the receipt of incoming data. Perform the following commands as user **ldad**:

**TYPE:** `cd $LOG_DIR/<yyyymmdd>`  
 ▪ Where **<yyyymmdd>** is today's date.

**TYPE:** `ps -ef |grep suaReceiver`  
 ▪ Displays the **suaReceiver** process. Notice the PID.

**TYPE:** `ls -rtal suaReceiver*`  
 ▪ Displays the latest logs for the **suaReceiver**.

**TYPE:** `tail -f <logname>`  
 ▪ Displays the log as it updates.

**NOTE:** The **suaReceiver** log containing the PID of the **suaReceiver** process is the current log.

#### Log Message Format

An entry at the beginning of this log looks like the following:

```
LOG-STATUS: Log file opened on host ls1-tbw4 at Wed May 12 00:01:49 2006
00:01:49.793 suaReceiver.C EVENT: suaReceiver process started ...
00:01:52.393 suaReceiver.C EVENT: Connection established with pseudo terminal
device
11:00:50.333 SignalClient.C EVENT: Signal 15 (Terminate) received for clean
shutdown
LOG-STATUS: Log file opened on host ls1-tbw4 at Wed May 12 00:02:01 2006
00:02:01.046 suaReceiver.C EVENT: suaReceiver process started ...
00:02:02.077 LocalDataAcq.C PROBLEM: open() failed on terminal device file.
No such file or directory, errno = 2
Exiting...
```

The format of the log file consists of the following fields:

```
Time stamp      00:01:49 1999
File name      suaReceiver.C
Message Type    EVENT
Message string  Connection established with pseudo terminal
                device
```

### 8.14.2 *newLDADdataNotification*

The **newLDADdataNotification** process uses the file's name and a lookup table (**LDADinfo.txt**) to determine the type of data contained in the file and checks the LDAD products directory (**/data/Incoming**) periodically for ASOS/MicroART files.

The **newLDADdataNotification** process creates and sends an IPC message to the **CO\_serv** process using **createAndSendIPCmessage**. The message notifies **CO\_serv** that there are ASOS/MicroART files in the **/data/Incoming** directory.

If **newLDADdataNotification** fails to receive confirmation from **listener** within 5 minutes or if an **fstat** on the file to transfer fails, the product gets moved to the **/data/ldad/Problem** directory using **moveFileToProblemDir** process. Otherwise, the "processed" file is moved to the **/data/ldad/Processed** directory.

#### ► **To Access and Read the newLDADdataNotification Log**

This log resides on the active LS in the **\$LOG\_DIR** directory and records messages from the **newLDADdataNotification** process. Perform the following commands as user **ldad**:

```
TYPE:      cd $LOG_DIR/<yyyymmdd>
               ■ Where <yyyymmdd> is today's date.

TYPE:      ls -ltr newLDADdataNotification*
               ■ Displays the current day's newLDADdataNotification
                 logs from earliest to latest.

TYPE:      tail -f <logname>
               ■ Displays the latest registered messages as the log updates.
```

### **Log Message Format**

An entry at the beginning of this log looks like the following:

```
LOG-STATUS: Log file opened on host ls1-rnk at Wed May 12 00:00:23 2006
00:00:23.202 newLDADdataNotification.c EVENT: newLDADdataNotification process started
00:00:23.205 newLDADdataNotification.c EVENT: Reading /data/Incoming/ every 20 seconds
00:14:03.204 newLDADdataNotification.c EVENT: Processing :
/data/Incoming/SUACRWRR3CIN.dat
00:14:03.880 newLDADdataNotification.c EVENT: waitForReply SUCCESS on
/data/Incoming/SUACRWRR3CIN.dat
```

```
00:29:03.223 newLDADdataNotification.c EVENT: Processing :
/data/Incoming/SUACLERR7ILN.dat
00:29:03.951 newLDADdataNotification.c EVENT: waitforReply SUCCESS on
/data/Incoming/SUACLERR7ILN.dat
00:44:03.273 newLDADdataNotification.c EVENT: Processing : /data/Incoming/raindata.dat
```

The format of the log file consists of the following fields:

```
Time stamp          00:00:23.202
File name           newLDADdataNotification.C
Message type        EVENT:
Message string      newLDADdataNotification process started
```

### 8.14.3 CO\_serv

**CO\_serv** initially sets up a TCP/IP socket and waits for connections. The **newLDADdataNotification** process creates and sends an IPC message to the **CO\_serv** using **createAndSendIPCmessage** routine. The message notifies **CO\_serv** that there are processed files in the **/data/Incoming** directory. The notification received from **newLDADdataNotification** is passed to the **listener**.

#### ► To Access and Read the CO\_serv Log

The **CO\_serv** log resides on the active LS in the directory **\$LOG\_DIR** and records messages from the **CO\_serv** process. Perform the following commands as user **ldad**:

```
TYPE:      cd $LOG_DIR/<yyyymmdd>
               ■ Where <yyyymmdd> is today's date.

TYPE:      ls -ltr CO_serv*
               ■ Displays the current day's CO_serv logs from earliest to
                 latest.

TYPE:      tail -f <logname>
               ■ Displays the latest registered messages as the log updates.
```

#### Log Message Format

An entry at the beginning of this log looks like the following:

```
LOG-STATUS: Log file opened on host ls1-rnk at Wed May 12 00:00:17 2006
00:00:17.076 co_serv_main.c EVENT: CO_serv process started
00:05:07.791 co_serv_main.c EVENT: CO_serv received a socket connection at: May12 06
00:05:07 GMT
00:05:07.801 co_serv_main.c EVENT: R message Received by CO_serv.....
00:06:36.988 co_serv_main.c EVENT: CO_serv received a socket connection at: May12 06
00:06:36 GMT
00:06:36.995 co_serv_main.c EVENT: R message Received by CO_serv.....
00:13:48.283 co_serv_main.c EVENT: CO_serv received a socket connection at: May12 06
00:13:48 GMT
00:13:48.291 co_serv_main.c EVENT: R message Received by CO_serv.....
```

The format of the log file consists of the following fields:

```
Time stamp      00:00:17.076
File name       co_serv_main.c
Message type    EVENT:
Message string  CO_serv process started
```

#### 8.14.4 listener

The **listener** reads the **LDADinfo.txt** config file, sets up a socket, binds its local address so that the Client (**CO\_serv**) can send to it, and waits for the connection from the Client process. When the notification is received, the **listener** retrieves the ASOS/MicroART file from the **/data/Incoming** directory on the active LS and copies it to the **\$LDAD\_DATA/tmp** directory on the PX. The **listener** sends a verification when it is finished.

The **listener** executes the **preprocessSUA.pl** script to preprocess the ASOS/MicroART data files. The **listener** receives the fully qualified data file, the hostname used by notification routine, the port number of the process requiring notification upon completion of the preprocessing, and other necessary information about the ASOS/MicroART data file format from **CO\_serv**.

#### ► To Access and Read the listener Log

The **listener** log resides on PX2 in the directory **\$LOG\_DIR** and records messages from the **listener** process. Perform the following commands as user **ldad**:

```
TYPE:      cd $LOG_DIR/<yyyymmdd>
               ■ Where <yyyymmdd> is today's date.

TYPE:      ls -ltr listener*
               ■ Displays the current day's listener logs from earliest to latest.

TYPE:      tail -f <logname>
               ■ Displays the latest registered messages as the log updates.
```

#### Log Message Format

An entry at the beginning of this log looks like the following:

```
LOG-STATUS: Log file opened on host px2-rnk at Wed May 12 00:00:41 2006
00:00:41.606 listener.c EVENT: listener process started
00:01:39:002 listener.c EVENT: do_G_Msg: rcv completed for
SUAWBAEVIAD.dat.1029783689
00:01:39:125 listener.c EVENT: do_G_Msg: Preprocessor Command Line=
</awips/ldad/bin/preprocessSUA.pl
/data/fxa/LDAD/tmp/SUAWBAEVIAD.dat.1029783679 px
15009>
```

The format of the log file consists of the following fields:

```
Time stamp      00:01:39:002
File name      listener.c
Message type    EVENT:
Message string  do_G_Msg: rcp completed for
                SUAWBABVIAD.dat.1029783689
```

#### 8.14.5 *preprocessSUA.pl*

The **preprocessSUA.pl** script preprocesses ASOS/MicroART data files containing surface observations for the LDAD text decoder. These data files are pulled across the security firewall from the external side and stored on the internal side in the **\$LDAD\_DATA/tmp** directory. The file name uses the following convention: **SUA<AFOS\_ID>.dat**, where SUA is a data type identifier corresponding to those listed in the **LDADinfo.txt** file and **<AFOS\_ID>** is a seven- to nine-character AFOS product identifier.

The **preprocessSUA.pl** script enables WAN distribution of the processed files to the NCF. After the files are successfully disseminated over the WAN, the **preprocessSUA.pl** script moves the files from the **\$LDAD\_DATA/tmp** directory to the **\$FXA\_DATA/archive/obs/scratch** directory.

#### ► To Access and Read the preprocessSUA Log

The **preprocessSUA** log resides on PX2 in a time-stamped directory under **\$LOG\_DIR**. Perform the following commands as user **ldad**:

```
TYPE:      cd $LOG_DIR/<yyyymmdd>
               ■ Where <yyyymmdd> is today's date.

TYPE:      ps -ef |grep preprocessSUA
               ■ Displays the preprocessSUA process. Notice the PID
                 process.

TYPE:      ls -rtal preprocessSUA*
               ■ Displays the latest logs for the preprocessSUA process.
```

**NOTE:** The **preprocessSUA** log containing the PID of the **preprocessSUA** process is the current log.

```
TYPE:      tail -f <logname>
               ■ Displays the log as it updates.
```





- TYPE:** `cd $LOG_DIR/<yyyymmdd>`
- Where **<yyyymmdd>** is today's date.
- TYPE:** `ps -ef |grep ldad`
- Displays the **ldad** processes.
- TYPE:** `ls -ltr distributeProduct*`
- Displays the latest logs for the **distributeProduct** process.
- TYPE:** `tail -f <logname>`
- Displays the log as it updates.

### Log Message Format

An entry at the beginning of the log looks like the following:

```
LOG-STATUS: Log file opened on host px2-tbdw at Wed May 12 01:09:57 2006
01:09:57.219 MHSProduct.C PROBLEM: Product
(/data/fxa/ispan/hydro/temp/A_format.974682596) is empty.
01:09:57.312 MHSProduct.C EVENT: Sending attachments
(/data/fxa/ispan/hydro/temp/A_format.974682596)
only. Attachments are assumed to contain correct communications header.
01:09:58.528 MHSProduct.C EVENT: Product request (KSTORRZLDA) was successfully submitted
to the MHS request server for distribution.
    Message Attributes:
    Request ID: TBDW-32838
    To: DEFAULTINCF
    Priority: 0
    Type: Routine
    Subject:
    Handling Action: 0
01:09:58.529 MHSProduct.C EVENT: TBDW-32838
```

The format of the log consists of the following fields:

|                |                                                                                                    |
|----------------|----------------------------------------------------------------------------------------------------|
| Time stamp     | 01:09:58.528                                                                                       |
| File name      | MHSProduct.C                                                                                       |
| Message type   | EVENT                                                                                              |
| Message string | Product request (KSTORRZLDA) was successfully submitted to the MHS request server for distribution |

## 8.15 Using LDAD Scheduler

### 8.15.1 Using LDAD Scheduler to Modify Gauges with Session Files

Selecting the **Modify Gauges...** button in the LDAD Scheduler will cause the **Modify Gauges** dialog box to launch. Allow a few moments for it to open because it is a large file. Within this dialog box, you can create or modify gauges (see Exhibit 8.15.1-1).

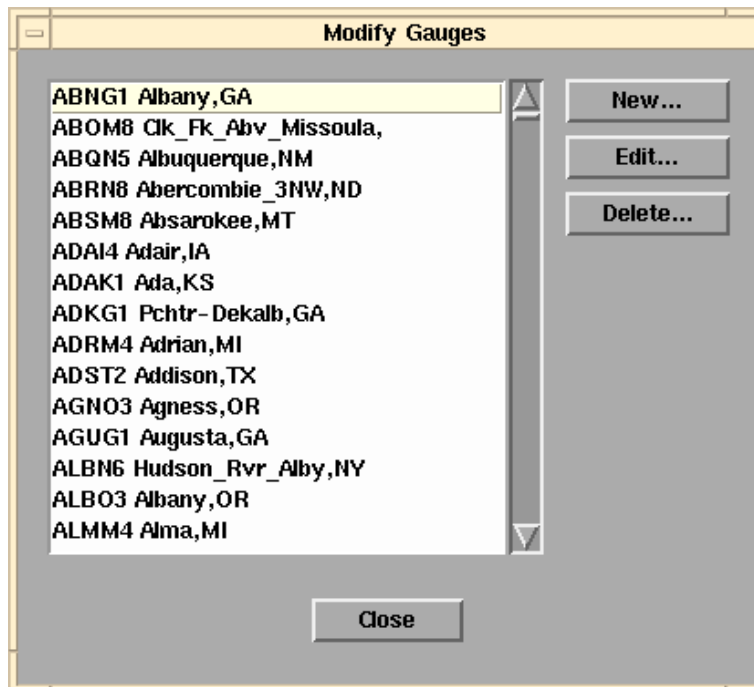

Exhibit 8.15.1-1. The Modify Gauges Dialog Box

- **Edit...:** In the **Modify Gauges** dialog box, the **Edit** button opens the **Edit Gauge** dialog box, which allows you to modify information for a selected gauge. The options are as follows:
  - **ID:** The entry box is for the five-character gauge ID.
  - **Non-NWS ID (if any):** The entry box is for a gauge ID that does not belong to the NWS, if it exists.
  - **Description:** Gauge location or other helpful information.
  - **Phone:** The dial-in phone number. You should check all gauges to verify their local or long distance number, including area codes. Be sure to include external access codes (i.e., some offices require that a 9 be dialed before an external phone number).
  - **Terminal Server:** Terminal server name. The terminal server connects your machine to the modems that dial into the gauges.
  - **Gauge Model:** This option menu specifies the type of gauge. Currently, the choices are “Handar,” “Campbell,” or “Sutron.” Depending on which option is selected, you may need to provide more information specific to the gauge model.
    - **Handar-Specific Information:** These elements will appear when you select “Handar” from the **Gauge Model** option menu.
      - **Collected Data:** This option menu specifies which data the gauge collects. The value is used to determine which session file is used. This option has no effect if you choose an alternate session file (the menu will display “Unspecified”). If the session file is being selected automatically, using the value

“Unspecified” has the same effect as using the value “River Stage.”

- **Campbell-Specific Information:** The element shown in Exhibit 8.15.1-2 will appear when you select “Campbell” from the **Gauge Model** option menu.
  - **Time Zone:** This option menu specifies the time zone used in data reported by the gauge.
  - **Setup...:** These menu buttons will open an **Edit Storage Area Reporting Format** dialog box.
  - **Has Second Storage Area:** Select this option if the gauge is equipped with a second storage area.

Exhibit 8.15.1-2. Campbell-Specific Information

- **Sutron-Specific Information:** The elements shown in Exhibit 8.15.1-3 will appear when you select “Sutron” from the **Gauge Model** option menu.
  - **Time Zone:** This option menu specifies the time zone used in the data reported by the gauge.
  - **Setup...:** This menu button will open an **Edit Storage Area Reporting Format** dialog box.

Exhibit 8.15.1-3. Sutron-Specific Information

- **Edit Storage Area Reporting Format:** This dialog box specifies the data reported by a Campbell or Sutron gauge and appears when you select the **Setup** buttons. It is shown in Exhibit 8.15.1-4 and has the following options:
  - **Array ID:** This entry box specifies the array ID associated with the storage area. This option is only present for Campbell gauges.

- **Reported Data:** This list contains the data elements reported by the gauge. The order of elements in this list must match the order of the reported data. The list may contain up to eight elements.
- **Add...:** This menu button will open a menu of the elements that gauges report. Select an item from the menu to add an element to the **Reported Data** list. Use the last menu item, “(skip this field),” to indicate a reported element that you do not want to include in the collected data.
- **Remove:** This menu button removes the selected element from the **Reported Data** list.
- **Move up:** This menu button will move a selected list element one position.

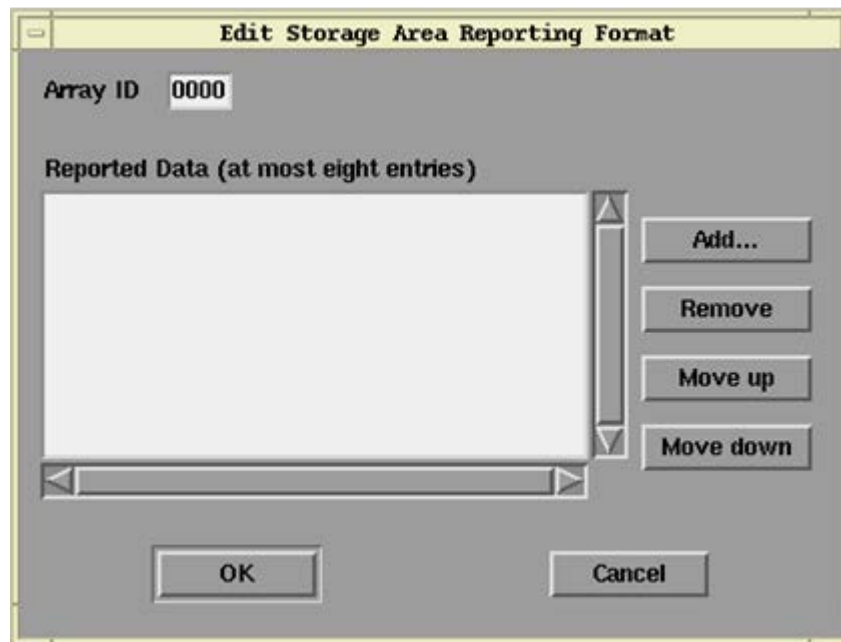

Exhibit 8.15.1-4. The Edit Storage Area Reporting Format Dialog Box

When you select the “New” button from the Modify Gauges, the following three options would be provided.

- **Select Session File:** If this option is selected, the Scheduler will determine which session file should be used. A session file is a text based script that is used to collect data from an external user or disseminate data to an external user. Typically, the script is written in UNIX scripting language.
- **Use Alternate Session File:** Selecting this option will enable the following options and allows you to choose a specific session file. There are also options for creating and modifying session files.

- **Choose...:** This menu button opens the **Choose Session File** dialog box, shown in Exhibit 8.15.1-5, and has the following options:

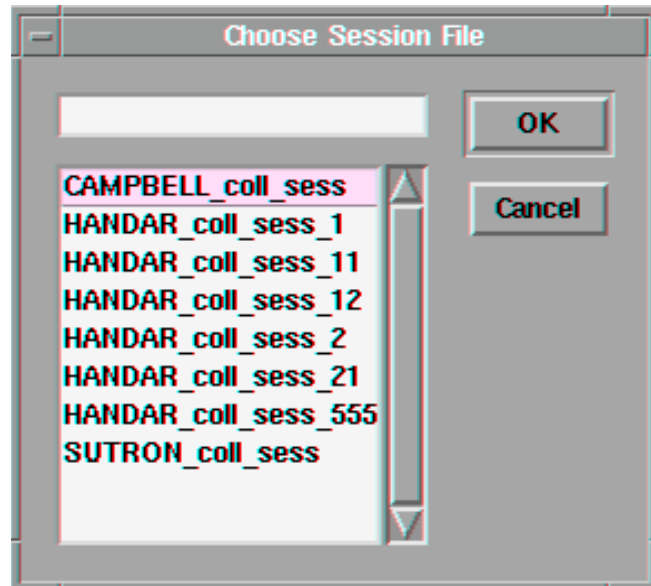

Exhibit 8.15.1-5. The Choose Session File Dialog Box

- **Entry Box:** You can enter a session file name in this entry box.
- **List of Sessions:** This is a list of session files. The list may not contain all valid session files, in which case you may simply enter the name in the Entry box.
- **OK:** Once you have selected a session file, this menu button closes the dialog box.
- **Cancel:** This menu button closes the dialog box without any changes.
- **Delete...:** In the **Modify Gauges** dialog box, this button is context sensitive. What it deletes depends on what is highlighted in the gauge list. A confirmation dialog box appears to verify your deletion.
- **Close:** This button closes the **Modify Gauges** dialog box.

### ► Editing Session Files

In the **Choose Session File** dialog box, you can activate editing by double-clicking on a session file name in the Session File Entry Line. It opens an **Edit Gauge** dialog box with the gauge ID, description, etc. Choosing “Use Alternate Session File” opens the **Edit Session File** dialog box, where you create or modify a session file to acquire data from a gauge (refer to Exhibit 8.15.1-6).

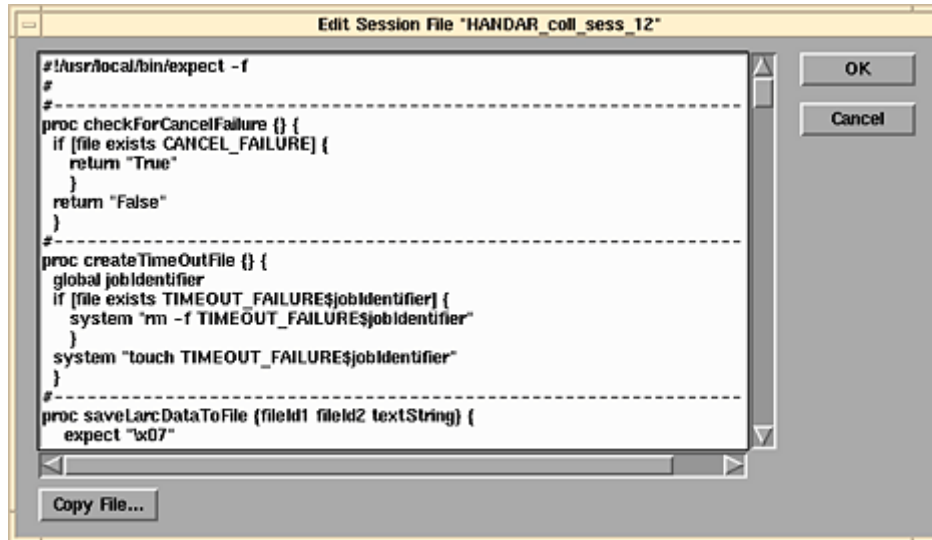

Exhibit 8.15.1-6. The Edit Session Dialog Box with the Contents of a Session File

LDAD session files are text-based files that are read by the LDAD Scheduler to acquire or disseminate data to or from a remote source. All of the gauges in the country were entered into a table prior to installation so you may only have to modify a preexisting gauge session file. To create a new gauge, refer to Chapter 9 of the AWIPS II CAVE-D2D User's Manual.

The LDAD Scheduler program executes text-based script files that run the UNIX **Expect** scripting language to acquire data from gauges. **Expect** is a Tcl-based toolkit for automating interactive programs. For data collection, the LDAD Scheduler uses the **Expect** script session file to control the commands that are sent to the gauge to look for specific responses, and to capture data when it is sent. Here is a section of an **Expect** script used to retrieve data from a gauge:

```

if { [checkForCancelFailure] == "True" } { exit }
  sleep 2
  expect {
    timeout {createTimeOutFile; exit}
    "OK" {send "atdt"}
  }
if { [checkForCancelFailure] == "True" } { exit }
  sleep 2
  expect {
    timeout {createTimeOutFile; exit}
    "BUSY" {createTimeOutFile; exit}
    "NO CARRIER" {createTimeOutFile; exit}
    "CONNECT"
  }
if { [checkForCancelFailure] == "True" } { exit }
  sleep 5
  expect {
    timeout {createTimeOutFile; exit}
    <I> {sleep 2}
  }
  set fileId [open <O> w]

```

Any characters enclosed in angle braces (<>) will be replaced with values that are extracted from the **ldadScheduler** information for the particular gauge dialed.

1. **<I>**: When **<I>** (uppercase i) appears in an **Expect** clause, the name of the gauge that is being dialed is substituted for the **<I>** field.
  2. **atdt** means “get the phone number for the gauge.” The Expect script executes the command **atdt <phone\_number>** to dial the gauge.
  3. **<O>** is replaced with the name of the temporary file to which the downloaded gauge data are stored.
  4. **<T>** (not shown) is replaced with the Terminal Server machine name retrieved from the database.
- **Copy File...:** In the **Edit Session File** dialog box, this button opens the **Copy File Contents** dialog box from which you can select a session file and view its contents. Refer to Exhibit 8.15.1-7.

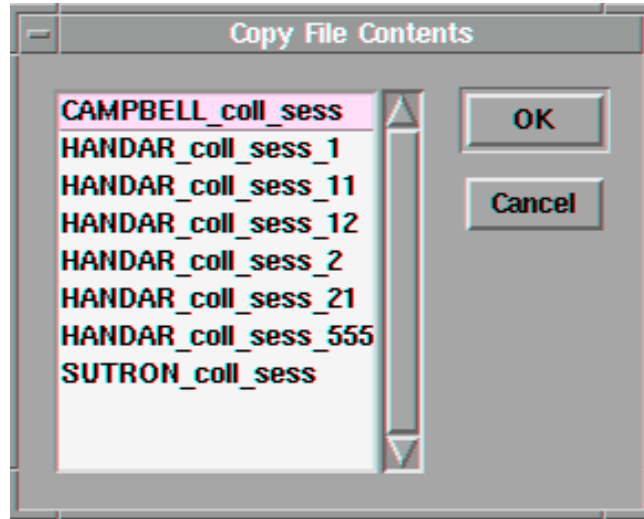

Exhibit 8.15.1-7. The Copy File Contents Dialog Box

- **OK:** Adds the selected session file and closes the **Copy File Contents** dialog box.
  - **Cancel:** Closes the **Copy File Contents** dialog box without making any changes.
- **OK:** In the **Edit Session File** dialog box, this button acknowledges your modifications to the session file and closes the **Edit Session File** dialog box.
  - **Cancel:** This button closes the **Edit Session File** dialog box without making any changes to a session file.



### 8.15.2 Using LDAD Scheduler to Add Users

The LDAD Scheduler allows system managers to add users and modify user information. Selecting the **Modify Users...** button on the LDAD Scheduler will cause a **Modify Users** window to appear (see Exhibit 8.15.2-1). This window provides options that allow you to create and/or modify database entries for external users. External users are outside persons or groups to whom you can send LDAD data and from whom you can receive LDAD data. You need to have site information for external users, such as the IP address, site login, and password, as well as relevant file names. The **Modify Users** dialog box contains all the options needed to set up an external user.

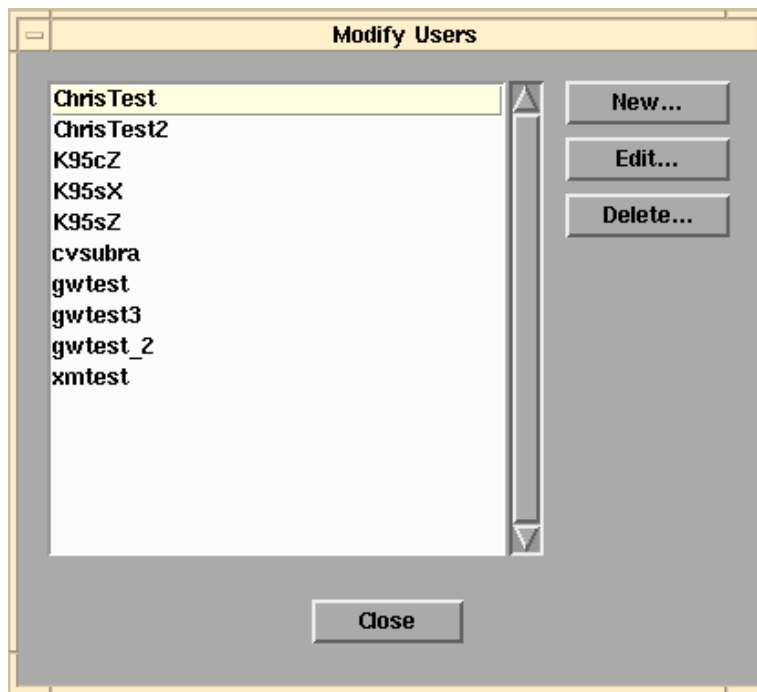

Exhibit 8.15.2-1. The Modify Users Dialog Box

#### ► Adding a New User

Selecting the **New...** button opens the **New User** dialog box, shown in Exhibit 8.15.2-2, which contains entry lines for the necessary information needed to access a new user. The fields, which are the same ones used when modifying a user, are as follows:

Exhibit 8.15.2-2. The New User Dialog Box

- **ID:** The name of the external user to be stored for the LDAD Scheduler.
- **Description:** Location and other useful information about the external user.
- **Type:** You must choose from this options menu whether this user is for collections or disseminations.
  - Choose **Collection** if you are gathering data from an external user.
  - Choose **Dissemination** if you are transmitting data or information to an external user.
- **Protocol:** An options menu with the list of LDAD-supported data transfer protocols (FTP, Kermit, Xmodem, Ymodem, and Zmodem). You and the external user need to both be using the same protocol.
- **Login:** If required, enter the external user’s login name on his/her remote machine (to replace “<L>” in a session file).
- **Password:** If required, enter the encrypted password for the external user on his/her remote machine (to replace “<P>” in a session file).
- **Local Directory:** Enter the directory path on your system to which data files are to be stored (to replace “<D>” in a session file).

- **Remote Directory:** Enter the directory name of the external user to which you send data files (to replace “<R>” in a session file).
- **File:** Enter the file name to be collected or disseminated (to replace “<N>” in a session file).
- **File Transfer Protocol (FTP) Machine/Terminal Server:** This option is modal based on your selected protocol.
  - For FTP protocol, this option is labeled **FTP Machine**. Enter the FTP machine name or IP address of the user’s machine.
  - For Kermit, Xmodem, Ymodem, or ZModem, this option is labeled **Terminal Server**. You should enter **7e1out** for LARC gauges and **8n1out** for Campbell, Sutron, and Handar 555 gauges in this entry line.
  - This entry will replace “<A>” or “<T>” in the session file, use “<A>” for the IP address and “<T>” for the Terminal Server.
- **Phone:** This option is dimmed for FTP transfers. It is activated for Kermit, Xmodem, Ymodem, or Zmodem transfers; enter the phone number of the user’s system.
- **Session File:** You can enter a session file name in this entry box or choose one from the **Choose Session File** dialog box.

There are two buttons at the bottom of the **New User** dialog box, **Choose...** and **Edit**, but only the **Choose...** button can be selected initially.

- **Choose...:** Opens the **Choose Session File** dialog box from which you can select a session file.
  - **Entry Box:** This allows you to specify a session file name in this entry box.
    - **List of Sessions:** This is a list of existing session files.
  - **OK:** Once you have selected a session file, this menu button adds the selected session file.
  - **Cancel:** This menu button closes the **Choose Session File** dialog box without making any changes.
- **Edit...:** This menu button is activated when a session file name is entered in the **Session File Entry Line**. It opens the **Edit Session File** dialog box.

This menu option is where a user creates a session file to collect data from an external user, or disseminate data to an external user using the data transfer protocol set under the **Add New External User Basic Information** window. As mentioned previously, session files are text-based files that are read by LDAD Scheduler to acquire or disseminate data to or from a remote source. Here is an example of a typical session file for collecting data from an external user using the UNIX FTP data transfer protocol. Any characters in angle braces (< >) are replaced by the LDAD Scheduler with values that are extracted from the database for the external user for whom the session file is saved.

```

/usr/bin/ftp -i -n <A><<EOT
user <L><P>
ascii
lcd <D>
cd <R>
mget <N>
quit
EOT

```

1. <A> is replaced with the IP address of the external user's machine.
  2. <L> and <P> are replaced with the login name and password fields.
  3. <D> is the local directory on the active LS.
  4. <R> is the remote directory on the external user's machine.
  5. <N> is the name of the file that is to be sent (received) to (from) the external user.
    - a. Set the string before the <N> character to **mget** if the session file is for data collection.
    - b. Set it to **mput** if the session file is for data dissemination.
- **OK** acknowledges the entries in the **Edit User** dialog box and closes it.
  - **Cancel** closes the **Edit User** dialog box without making any changes.
  - **Close** closes the **Modify User** dialog box without making any changes.
  - **Submit** sends a highlighted request to the active LS to process your request. This button is enabled only if a request containing at least one ID is highlighted in the **Existing Requests List**. The status and results of the request appear automatically in the **Status** dialog box shown in Exhibit 8.15.2-3.

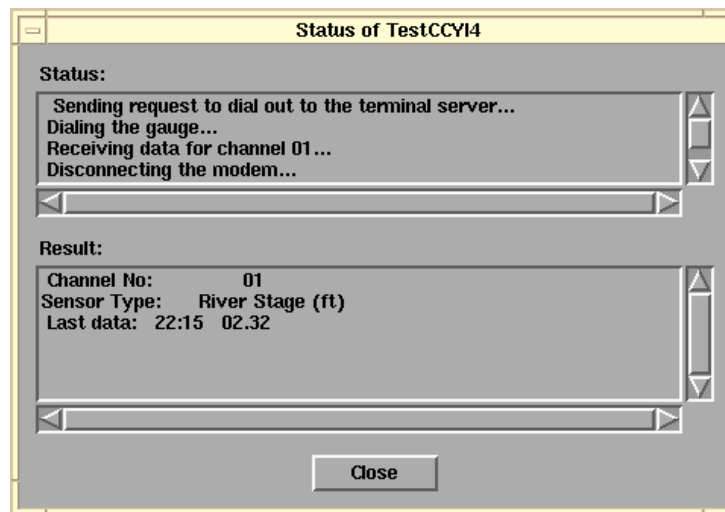

Exhibit 8.15.2-3. The Status Dialog Box

- **Close:** The **Close** menu button closes the **LDAD Scheduler** dialog box.

## 8.16 Alaska Profiler Data

The Alaska profiler application was implemented to allow the Alaska NWS forecast offices to display their local boundary layer profiler data on AWIPS by translating the data they decode and store into the netCDF format required by AWIPS.

### Processes

```

LS      newLDADdataNotification
LS      CO_serv
PX2     listener
PX2     CommsRouter LDAD_ROUTER
PX2     DataController LDAD_ROUTER LdadController.config
PX2     routerStoreAkBlpEDEX
DX1     notificationServer

```

### Configuration Files (all in /data/fxa/LDAD/data)

```

LDADinfo.txt           (for listener)
JNUStation.txt        (for routerStoreAkBlpEDEX)
LdadController.config (for DataController LDAD_ROUTER)
LdadPatterns.txt      (for routerStoreAkBlpEDEX)
jnu.desc              (for routerStoreAkBlpEDEX)

```

### Configuration File in /awips/fxa/data

```

edex-info.txt         (for routerStoreAkBlpEDEX)

```

### LDADinfo.txt

This file should contain the following entry:

```

jnu      |JNU      | 88 | 0 |PROFILER |profiler | null |

```

Once the file is installed, this line should not be modified.

### JNUStation.txt

The following is a sample of this file to show its format. To add a new profiler, use this format to create a new entry in the station table (\* indicates a mandatory field):

```

sd |SDIA2 | South Douglas Island AK | 4|58.27725|-134.38898|GMT|||1|||
nd |NDIA2 | North Douglas Island AK | 45|58.33665|-134.56290|GMT|||1|||
lc |LMNA2 | Lemon Creek AK | 5|58.35610|-134.50810|GMT|||1|||

```

- **Provider ID:** Data provider station ID (\*)
- **AFOS(HB5) ID:** The AFOS or Handbook 5 ID (NWS-assigned)
- **Station Name:** Text name of station

- **Elevation:** Station elevation (m) (\*)
- **Latitude:** Station Latitude (decimal degrees, north positive) (\*)
- **Longitude:** Station Longitude (decimal degrees, east positive) (\*)
- **Local Time Zone:** Reporting time zone (e.g., UTC, PST8PDT) (\*)
- **Location Description:** Station location/address (Text)
- **Station Type:** Station type (e.g., tower, surface, floating platform)
- **Number of Instruments:** Number of reporting instruments for the station
- **Number of Reporting Levels:** Number of data reporting levels. Level information should be provided in the instrument table
- **Maintenance/Calibration Schedule:** Frequency of maintenance/calibration
- **Site Description:** Text description of the site surroundings.

**NOTE:** Entries are sorted alphabetically by the gauge ID.

**NOTE:** This file must be identical on the PX2 and on the LS machines.

### **LdadController.config**

This file enables the startup of LDAD- related processes. The Data Controller reads this file and executes its contents.

```
routerStoreText           true
routerShefEncoderEDEX    true
routerStoreEDEX           true
routerStoreAkBlpEDEX     true
routerLdadDecoder        true
eof eof
```

Refer to Exhibit 8.16-1 for the Decode Alaska Profiler data flow diagram.

#### **8.16.1 newLDADdataNotification**

The **newLDADdataNotification** process uses the file's name to determine the type of data it contains and checks the LDAD products directory (**/data/Incoming**) periodically for Alaska profiler files.

The **newLDADdataNotification** process creates and sends an IPC message to the **CO\_serv** process, using **createAndSendIPCmessage**, to notify it that there are Alaska profiler files in the **/data/Incoming** directory.

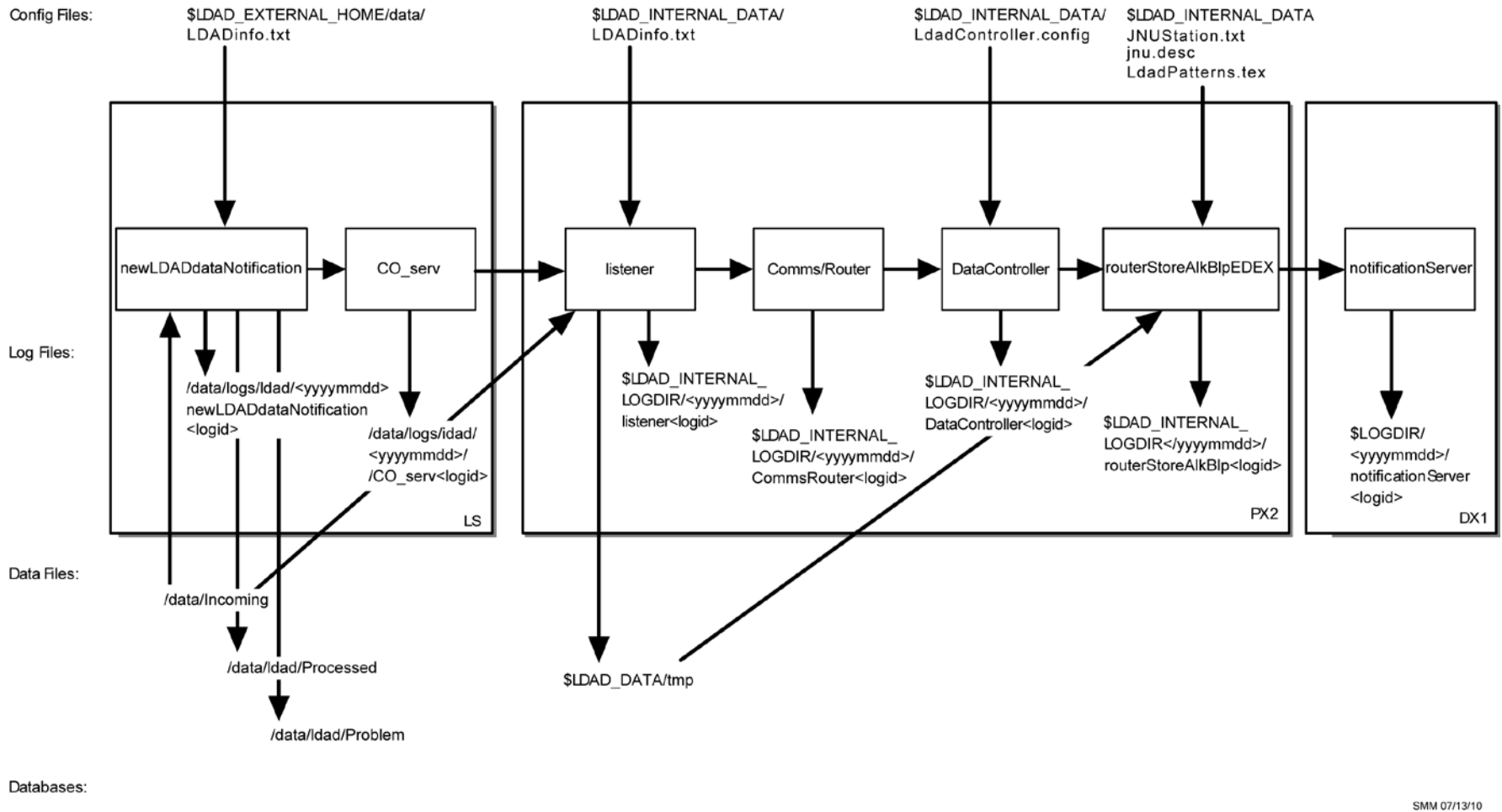

Exhibit 8.16-1. Decode Alaska Profiler Data

If **newLDADdataNotification** fails to receive confirmation from **listener** within 5 minutes, or if an **fstat** on the file to transfer fails, the product is moved to the **/data/ldad/Problem** directory using the **moveFileToProblemDir** process. Otherwise, the “processed” files are moved to the **/data/ldad/Processed** directory using the **moveFileToProcessedDir** process.

► **To Access and Read the newLDADdataNotification Log**

The **newLDADdataNotification** log resides on the active LS in the **\$LOG\_DIR** directory and records messages from the **newLDADdataNotification** process. Perform the following commands as user **ldad**:

- TYPE:** `cd $LOG_DIR/<yyyymmdd>`
- Where **<yyyymmdd>** is today’s date.
- TYPE:** `ls -ltr newLDADdataNotification*`
- Displays the current day’s **newLDADdataNotification** logs from earliest to latest.
- TYPE:** `tail -f <logname>`
- Displays the latest registered messages as the log updates.

### Log Message Format

An entry at the beginning of this log looks similar to the following:

```
LOG-STATUS: Log file opened on host ls1-tbdw at Wed May 12 00:00:28 2006
00:00:28.906 newLDADdataNotification.c EVENT: newLDADdataNotification process
started
00:00:28.911 newLDADdataNotification.c EVENT: Reading /data/Incoming/ every 20
seconds
00:00:28.915 newLDADdataNotification.c EVENT: Processing :
/data/Incoming/jnund19.dat.1040157788
13:45:41.926 newLDADdataNotification.c EVENT: waitForReply SUCCESS on
/data/Incoming/jnund19.dat.1040157788
```

The format of the log file consists of the following fields:

|                |                                                      |
|----------------|------------------------------------------------------|
| Time stamp     | 00:00:28.915                                         |
| File name      | newLDADdataNotification.c                            |
| Message type   | EVENT:                                               |
| Message string | Processing:<br>/data/Incoming/jnund19.dat.1040157788 |

### 8.16.2 CO\_serv

**CO\_serv** initially sets up a TCP/IP socket and waits for connections. The notification received from **newLDADdataNotification** is passed across the firewall to the **listener** process on the internal side on the PX.



► **To Access and Read the CO\_serv log**

The **CO\_serv** log resides on the active LS in the **\$LOG\_DIR** directory and records messages from the **CO\_serv** process. Perform the following commands as user **ldad**:

- TYPE:**        `cd $LOG_DIR/<yyyymmdd>`  
                   ▪        Where **<yyyymmdd>** is today's date.
- TYPE:**        `ls -ltr CO_serv*`  
                   ▪        Displays the current day's **CO\_serv** logs from earliest to latest.
- TYPE:**        `tail -f <logname>`  
                   ▪        Displays the latest registered messages as the current log updates.

### Log Message Format

An entry at the beginning of this log looks similar to the following:

```
00:00:17.076 co_serv_main.c EVENT: CO_serv process started
00:05:07.791 co_serv_main.c EVENT: CO_serv received a socket connection at:
May12 06 00:05:07 GMT
00:05:07.801 co_serv_main.c EVENT: R message Received by CO_serv.....
00:06:36.988 co_serv_main.c EVENT: CO_serv received a socket connection at:
May12 06 00:06:36 GMT
00:06:36.995 co_serv_main.c EVENT: R message Received by CO_serv.....
00:13:48.283 co_serv_main.c EVENT: CO_serv received a socket connection at:
May12 06 00:13:48 GMT
00:13:48.291 co_serv_main.c EVENT: R message Received by CO_serv.....
```

The format of the log file consists of the following fields:

```
Time stamp            00:00:17.076
File name             co_serv_main.c
Message type          EVENT:
Message string        CO_serv process started
```

### 8.16.3 listener

The **listener** reads the **\$FXA\_DATA/LDAD/data/LDADinfo.txt** configuration file, sets up a socket, binds its local address so that the client (**CO\_serv**) can send to it, and waits for the connection from the client process. When the notification is received, the **listener** retrieves the Alaska profiler file from the **/data/Incoming** directory on the active LS and copies it to the **\$LDAD\_DATA/tmp** directory on the PX. The **listener** sends a verification when finished.

The **listener** executes the **\$FXA\_HOME/ldad/bin/null** script to preprocess the Alaska profiler data files. The **listener** receives the fully qualified data file, the hostname used by

notification routine, the port number of the process to be notified when the preprocessing is completed, and other necessary information about the Alaska profiler data file format from **CO\_serv**. Finally, the **listener** sends notification to the **CommsRouter LDAD\_ROUTER** process that a product has been preprocessed.

### ► To Access and Read the listener Log

The **listener** log resides on PX2 in the **\$LOG\_DIR** directory and records messages from the **listener** process. Perform the following commands as user **ldad**:

- TYPE:** `cd $LOG_DIR/<yyyymmdd>`
- Where **<yyyymmdd>** is today's date.
- TYPE:** `ls -ltr listener*`
- Displays the current day's **listener** logs from earliest to latest.
- TYPE:** `tail -f <logname>`
- Displays the latest registered messages as the log updates.

### Log Message Format

An entry at the beginning of this log looks similar to the following:

```
00:00:12.616 listener.c EVENT: listener process started
20:43:10.068 listener.c EVENT: do_G_Msg: rcp completed for jnUSD22.dat.104015778
20:43:10:136 listener.c EVENT: do_G_Msg: Preprocessor Command Line =
</awips/ldad/bin/null /data/fxa/LDAD/tmp/jnUSD22.dat.104015778 px 15009>
```

The format of the log consists of the following fields:

```
Time stamp          20:43:10:136
File name           listener.c
Message type        EVENT:
Message string      do_G_Msg: Preprocessor Command Line =
                    </awips/ldad/bin/null
                    /data/fxa/LDAD/tmp/jnUSD22.dat.104015778 px
                    15009>
```

### 8.16.4 LDAD\_ROUTER

The **LDAD\_ROUTER** (registered **LDAD CommsRouter**) is responsible for transporting data notifications from the data acquisition processes to the data controller processes. The main function of the **LDAD\_ROUTER** is message passing; it does no data processing. The router provides a known location where the data acquisition processes can send data messages.

► **To Access and Read the CommsRouter Log**

The **CommsRouter** log resides on PX2 in a time-stamped directory under **\$LOG\_DIR**. Perform the following commands as user **ldad**:

**TYPE:** `cd $LOG_DIR/<yyyymmdd>`  
 ▪ here **<yyyymmdd>** is today's date.

**TYPE:** `ps -wef |grep ldad`  
 ▪ Displays the **ldad** processes. Notice the PID of the **CommsRouter** process owned by user **ldad**.

**TYPE:** `ls -rtal Comms*`  
 ▪ Displays the latest logs for the **CommsRouter**.

**NOTE:** The **CommsRouter** log containing the PID of the **LDAD\_ROUTER** process is the **LDAD\_ROUTER's CommsRouter** log.

**TYPE:** `tail -f <logname>`  
 ▪ Displays the log as it updates.

### Log Message Format

An entry in the log should look similar to the following:

```
20:42:59.742 CommsReceiver.C EVENT: NCF_ENTRY CRMsg Pattern: ^[0-9.]*[^\m]([\^s]([\^a]([\^s]([\^_]([\^q]([\^c])))\.\.\.decoded$|^jnu.*dat.[0-9]*$|(\.\.[0-9]+)|([\^0-9]*\.\msas_qc\.\.)*$|.*\/Text\/.*\.[0-9]+
20:43:12.048 CommsReceiver.C EVENT: NCF_ENTRY DSMsg: jnugd25.dat.1040157788 1 22
20:43:12.110 CommsReceiver.C EVENT: NCF_ENTRY DSMsg: jnugd23.dat.1040157788 1 22
20:43:12.161 CommsReceiver.C EVENT: NCF_ENTRY DSMsg: jnugd22.dat.1040157788 1 22
20:43:12.236 CommsReceiver.C EVENT: NCF_ENTRY DSMsg: jnugd19.dat.1040157788 1 22
20:43:12.370 CommsReceiver.C EVENT: NCF_ENTRY DSMsg: jnugd24.dat.1040157788 1 22
20:43:12.841 CommsReceiver.C EVENT: NCF_ENTRY DSMsg: /data/fixa/LDAD/Text/RAWS.dat.1040157788 1 39
```

The log consists of the following fields:

|                |                                              |
|----------------|----------------------------------------------|
| Time stamp     | 20:43:12.048                                 |
| File name      | CommsReceiver.C                              |
| Message type   | EVENT:                                       |
| Message string | NCF_ENTRY DSMsg: jnugd25.dat.1040157788 1 22 |

The **LDAD\_ROUTER CommsRouter** is started automatically at system reboot time or can be started manually. The **CommsRouter** runs continuously, exiting only when killed by the restart program.

### 8.16.5 DataController

The **DataController** is responsible for creating the decoder and storage processes (as child processes), restarting them if they exit, routing appropriate messages to them, and

queuing incoming data messages until the decoder and storage processes are ready. As data messages are stored in the queue, the size of the processes grows.

The **DataController**'s main program creates a **DataRouting** manager object when it first starts up and invokes a member function to start the **routerStoreAkBlpEDEX** process by reading and executing the **LdadController.config** file. The file resides in **\$LDAD\_INTERNAL\_DATA** and contains the name of the process above (as well as the **routerLdadDecoder**, **routerStoreEDEX**, **routerStoreTextEDEX**, and **routerShefEncoderEDEX** processes) to start/restart, a restart flag, and end of file (**eof**) designator to alert the Data Routing Manager that there are no more processes listed in the file.

The **DataController** sends product-received notifications to the **DataController**. When the process first starts up, it sends messages containing its IPC address and process number to the **DataController**. The process sends the **DataController** a data request message and a ready-to-receive data message. In response, the **DataController** stores the process ID (PID) information and data requests, and sends a message to the requesting process (if a message is available). The **DataController** waits to receive another ready message from the process before sending any more data messages. The **DataController** queues any messages it receives from the **DataController** until the process sends another ready message.

### ► To Access and Read the DataController Log

The **DataController** log resides on PX2 in a time-stamped directory under **\$LOG\_DIR**. Perform the following commands as user **ldad**:

- TYPE:** `cd $LOG_DIR/<yyyymmdd>`
- Where **<yyyymmdd>** is today's date.
- TYPE:** `ps -wef |grep ldad`
- Displays the **ldad** processes; note the PID for the **DataController** process owned by user **ldad**.
- TYPE:** `ls -rtal DataController*`
- Displays the latest logs for the **DataControllers**. Look for the log name that contains the PID you noted above.
- TYPE:** `tail -f <logname>`
- Displays the log as it updates with the latest messages.

### Log Message Format

An entry in the log should look similar to the following:

```
20:42:47.366 ChildProcess.C EVENT: /awips/fixa/bin/routerStoreAkBlp started
20:42:59.741 getCommsData.C EVENT: Data Request message sent to LDAD_ROUTER.
20:43:12.052 CommsReceiver.C EVENT: NCF_ENTRY CDMsg: jnusrd25.dat.1040157788 1 22
```

The log file consists of the following fields:

```
Time stamp      20:43:12.052
File name      CommsReceiver.C
Message type    EVENT:
Message string  NCF_ENTRY CMsg: jnugd25.dat.1040157788 1 22
```

### 8.16.6 *routerStoreAkBlpEDEX*

The **routerStoreAkBlpEDEX** process is spawned by the **DataController** as specified in the **LdadController.config** file. The **routerStoreAkBlpEDEX** process sends a data request to the **DataController** for the Alaska profiler products it wishes to receive by specifying product header patterns of interest. When notified by the **DataController** that a product of interest has arrived, the **routerLdadDecoder** reads the files contained in the **\$LDAD\_DATA/tmp** directory.

The **routerStoreAkBlpEDEX** process reads each file, decodes it and stores it in the **/data\_store/ldad** directory. A notification is sent to the **notificationServer**.

#### ► **To Access and Read the routerStoreAkBlpEDEX Log**

The **routerStoreAkBlpEDEX** log resides on PX2 in a time-stamped directory under **\$LOG\_DIR**. Perform the following commands as user **ldad**:

```
TYPE:      cd $LOG_DIR/<yyyymmdd>
               ■ Where <yyyymmdd> is today's date.

TYPE:      ps -wef |grep ldad
               ■ Displays the ldad process; note the PID of the
                 routerStoreAkBlpEDEX process.

TYPE:      ls -rtal routerStoreAkBlpEDEX*
               ■ Displays the latest routerStoreAkBlpEDEX logs; look for
                 the log file containing the PID noted above.

TYPE:      tail -f <logname>
               ■ Displays the log as it updates with the latest messages.
```

#### **Log Message Format**

An entry in the log should look similar to the following:

```
20:42:49.149 routerStoreAkBlpEDEX.C EVENT: routerStoreAkBlp.C; main(), pattern
<^jnu.*dat.[0-9]*$>
20:42:59.734 routerStoreAkBlpEDEX.C EVENT: eventLoop() pattern <^jnu.*dat.[0-9]*$>
20:43:12.121 storeAkBlpEDEX.C EVENT: AK BLP File:
</data/fxa/LDAD/tmp/jnugd19.dat.1040157788>
20:43:12.123 storeAkBlpEDEX.C EVENT: AK BLP File:
</data/fxa/LDAD/tmp/jnugd22.dat.1040157788>
```

The log file consists of the following fields:

```
Time stamp      20:43:12.123
File name       storeAkBlpEDEX.C
Message type    EVENT:
Message string  AK BLP File:
                </data/fxa/LDAD/tmp/jnugd22.dat.1040157788>
```

### 8.16.7 notificationServer

The **notificationServer** informs its display clients that a new version of a display product has become available. Data acquisition processes send data notification messages to the **notificationServer**, and it acts as a bridge between the data acquisition and workstation display components of AWIPS.

#### ► To Access and Read the notificationServer Log

The **notificationServer** log resides on the DX1 in the **\$LOG\_DIR** directory. This log records messages from the **notificationServer** process. Perform the following commands as user fxa:

```
TYPE:      cd $LOG_DIR/<yyyymmdd>
               ■ Where <yyyymmdd> is today's date.

TYPE:      ls -ltr notificationServer*
               ■ Displays the current day's notificationServer logs from
                 earliest to latest.

TYPE:      tail -f <logname>
               ■ Displays the latest registered messages as the log updates.
```

### Log Message Format

An entry at the beginning of the log looks similar to the following:

```
00:00:31.822 NotificationServer.C DIAG: Tried to generate notifications for
key: 3700 but the data notify time: 25.23 3HR does not match any times on the
inventory.
```

```
00:00:35.948 GridAccessor1.C EVENT: Updating inventory info for MRF
```

```
-----
Process ID of anonymous target: 29574
Host: lx2-rnk
Port number: 3231
NORMAL PRIORITY CONNECTION Connection created: Jan 18 06 16:25:32 GMT.
Initiated by connecting process.
Last time this connection was used: Jan 18 06 23:55:49 GMT
Sent messages since last stat: 4
Bytes per message (Avg/Min/Max): 544/540/548
No messages have been received since last stat report.
```

The log file consists of the following fields:

```

Time stamp      00:00:31.822
File name       NotificationServer.C
Message type    DIAG:
Message string  Tried to generate notifications for key: 3700
                but the data notify time: 25.23 3HR does not
                match any times on the inventory.

```

### 8.17 *Acquire and Process Radiosonde Replacement System (RRS) Data (for LDAD)*

Data acquisition occurs through FTP over the local (site) LAN and by dial-in using a PPP connection to perform FTP file transfer of products. The **newLDADdataNotification** script checks the LDAD directory for RRS files. When a file is available, the **newLDADdataNotification** process passes the information to the **CO\_serv** process. The **CO\_serv** passes the message to the listener, which executes the **preprocessRRS.pl** script. The **preprocessRRS.pl** script copies the file to a **tmp** directory and stores it into the **fxatext** database using the **textdb** command line interface. When the file is successfully stored in the database, a notification is sent to the **textNotificationServer**. Finally, the data are routed to the NCF via the WAN.

#### Processes

```

LS    newLDADdataNotification
LS    CO_serv
PX    listener
PX    preprocessRRS.pl
PX    distributeProduct

```

#### Configuration Files (all in /data/fxa/LDAD/data)

```

LDADinfo.txt          (for listener)
rcv_action2codes.txt (for distributeProduct)
siteCommission.txt    (for distributeProduct)
awips2afos.txt        (for preprocessRRS.pl)

```

Refer to Exhibit 8.17-1 for the Acquire and Process RRS data flow diagram.

#### 8.17.1 *newLDADdataNotification*

The **newLDADdataNotification** process uses the file's name and a lookup table (**LDADinfo.txt**) to determine the type of data the file contains and checks the LDAD products directory (**/data/Incoming**) periodically for RRS files.

The **newLDADdataNotification** process creates and sends an IPC message to the **CO\_serv** process using **createAndSendIPCmessage**. The message notifies **CO\_serv** that there are RRS files in the **/data/Incoming** directory.

If **newLDADdataNotification** fails to receive confirmation from **listener** within 5 minutes or if an **fstat** on the file to transfer fails, the product is moved to the **/data/ldad/Problem** directory using the **moveFileToProblemDir** process. Otherwise, the "processed" file is moved to the **/data/ldad/Processed** directory.

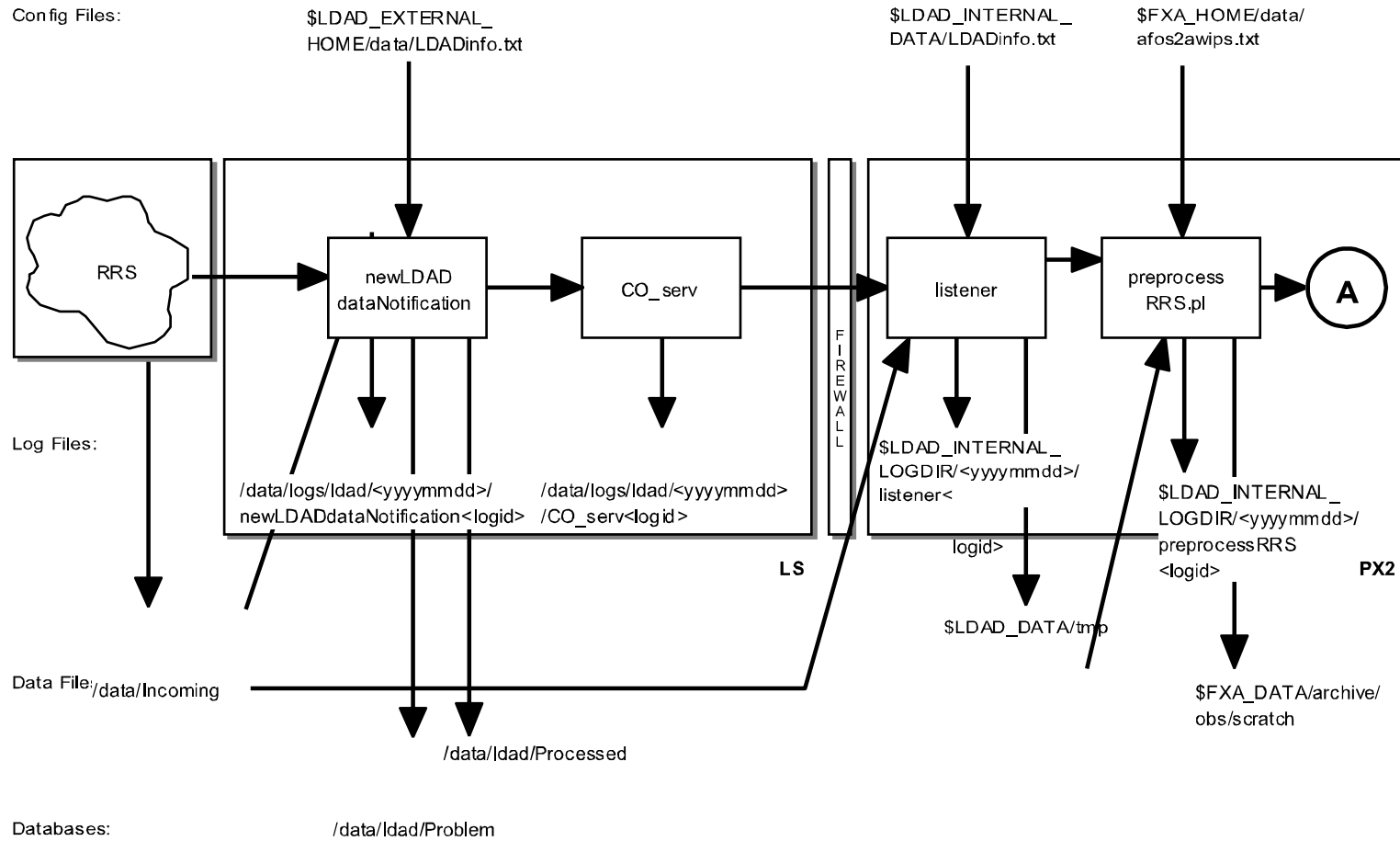

SMM 06/15/06

Exhibit 8.17-1. Acquire and Process RRS Data (for LDAD) (Page 1 of 2)



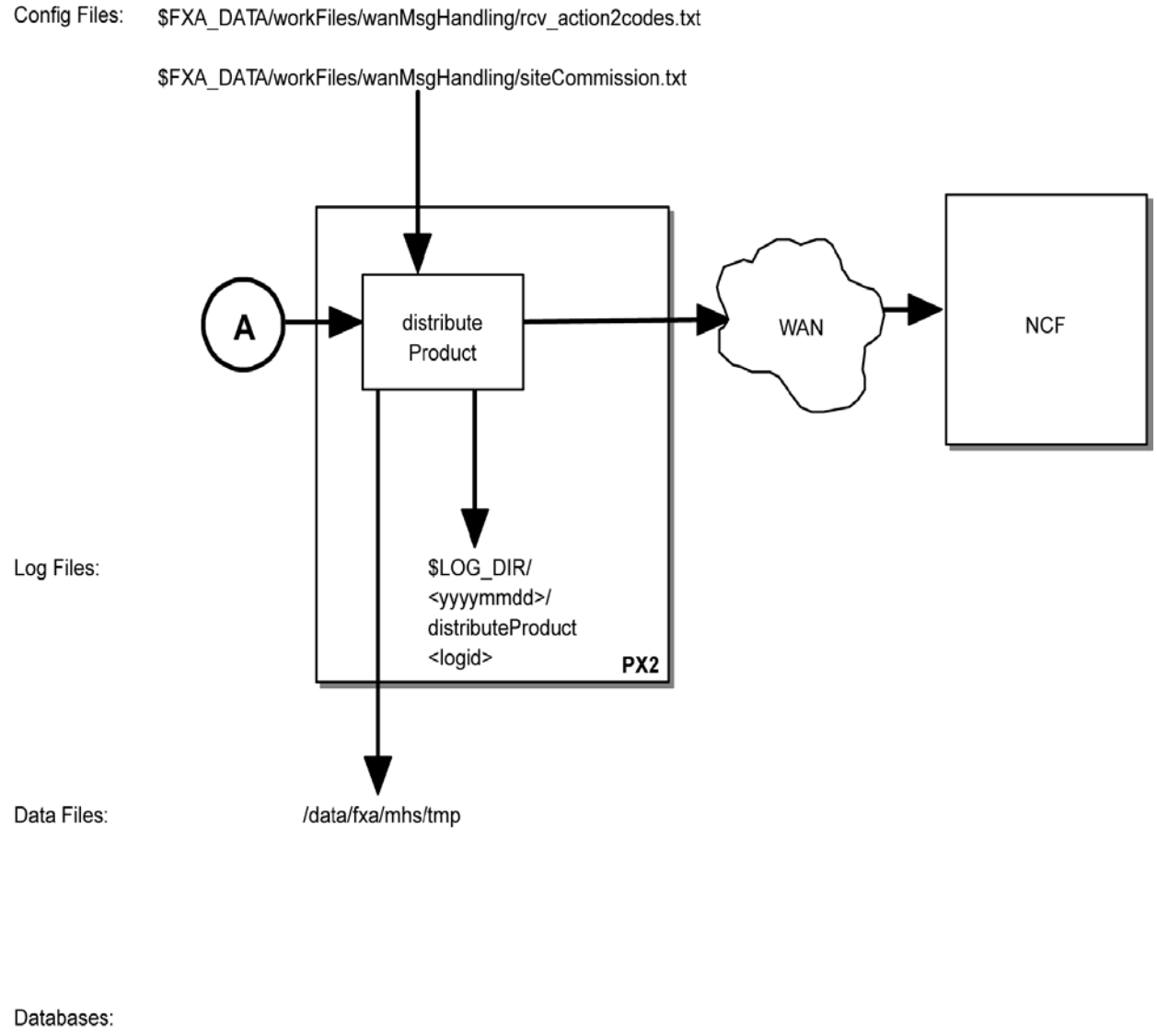

SMM 07/13/1C

Exhibit 8.17-1. Acquire and Process RRS Data (for LDAD) (Page 2 of 2)

► **To Access and Read the newLDADdataNotification Log**

This log resides on the active LS in the **\$LOG\_DIR** directory and records messages from the **newLDADdataNotification** process. Perform the following commands as user ldad:

- TYPE:**        cd \$LOG\_DIR/<yyyymmdd>
- Where <yyyymmdd> is today's date.
- TYPE:**        ls -ltr newLDADdataNotification\*
- Displays the current day's **newLDADdataNotification** logs from earliest to latest.
- TYPE:**        tail -f <logname>
- Displays the latest registered messages as the log updates.

**Log Message Format**

An entry at the beginning of this log looks similar to the following:

```
00:00:23.202 newLDADdataNotification.c EVENT: newLDADdataNotification process started
00:00:23.205 newLDADdataNotification.c EVENT: Reading /data/Incoming/ every 20 seconds
00:14:03.204 newLDADdataNotification.c EVENT: Processing :
/data/Incoming/RRSDENADRDENO.man
00:14:03.880 newLDADdataNotification.c EVENT: waitForReply SUCCESS on
/data/Incoming/RRSDENADRDENO.man
```

The format of the log file consists of the following fields:

|                |                                         |
|----------------|-----------------------------------------|
| Time stamp     | 00:00:23.202                            |
| File name      | newLDADdataNotification.c               |
| Message type   | EVENT:                                  |
| Message string | newLDADdataNotification process started |

**8.17.2 CO\_serv**

**CO\_serv** initially sets up a TCP/IP socket and waits for connections. The **newLDADdataNotification** process creates and sends an IPC message to the **CO\_serv** using **createAndSendIPCmessage** routine. The message notifies **CO\_serv** that there are processed files in the **/data/Incoming** directory. The notification received from **newLDADdataNotification** is passed to the **listener**.

► **To Access and Read the CO\_serv Log**

The **CO\_serv** log resides on the active LS in the directory **\$LOG\_DIR** and records messages from the **CO\_serv** process. Perform the following commands as user ldad:

- TYPE:**        cd \$LOG\_DIR/<yyyymmdd>

- Where **<yyyymmdd>** is today's date.

**TYPE:** `ls -ltr CO_serv*`

- Displays the current day's **CO\_serv** logs from earliest to late

**TYPE:** `tail -f <logname>`

- Displays the latest registered messages as the log updates.

### Log Message Format

An entry at the beginning of this log looks similar to the following:

```
00:00:17.076 co_serv_main.c EVENT: CO_serv process started
00:05:07.791 co_serv_main.c EVENT: CO_serv received a socket connection at: May12 06 00:05:07 GMT
00:05:07.801 co_serv_main.c EVENT: R message Received by CO_serv.....
00:06:36.988 co_serv_main.c EVENT: CO_serv received a socket connection at: May12 06 00:06:36 GMT
00:06:36.995 co_serv_main.c EVENT: R message Received by CO_serv.....
00:13:48.283 co_serv_main.c EVENT: CO_serv received a socket connection at: May12 06 00:13:48 GMT
00:13:48.291 co_serv_main.c EVENT: R message Received by CO_serv.....
```

The format of the log file consists of the following fields:

|                |                         |
|----------------|-------------------------|
| Time stamp     | 00:00:17.076            |
| File name      | co_serv_main.c          |
| Message type   | EVENT:                  |
| Message string | CO_serv process started |

### 8.17.3 listener

The **listener** reads the **LDADinfo.txt** config file, sets up a socket, binds its local address so that the Client (**CO\_serv**) can send to it, and waits for the connection from the Client process. When the notification is received, the **listener** retrieves the RRS file from the **/data/Incoming** directory on the active LS, copies it to the **\$LDAD\_DATA/tmp** directory on the PX, and sends a verification when it is finished.

The **listener** executes the **preprocessRRS.pl** script to preprocess the RRS data files. The **listener** receives the fully qualified data file, the hostname used by notification routine, the port number of the process requiring notification upon completion of the preprocessing, and other necessary information about the RRS data file format from **CO\_serv**.

#### ► To Access and Read the listener Log

The **listener** log resides on PX2 in the directory **\$LOG\_DIR** and records messages from the **listener** process. Perform the following commands as user **ldad**:

**TYPE:** `cd $LOG_DIR/<yyyymmdd>`

- Where **<yyyymmdd>** is today's date.

- TYPE:** `ls -ltr listener*`
- Displays the current day's **listener** logs from earliest to latest.
- TYPE:** `tail -f <logname>`
- Displays the latest registered messages as the log updates.

### Log Message Format

An entry at the beginning of this log looks similar to the following:

```
00:00:41.606 listener.c EVENT: listener process started
00:01:39:002 listener.c EVENT: do_G_Msg: rcp completed for
RRSDENADRDEN0.man.1029783689
00:01:39:125 listener.c EVENT: do_G_Msg: Preprocessor Command
Line=</awips/ldad/bin/preprocessRRS.pl
/data/fxa/LDAD/tmp/RRSDENADRDEN0.man.1029783689 px 15009>
```

The format of the log file consists of the following fields:

|                |                                                             |
|----------------|-------------------------------------------------------------|
| Time stamp     | 00:01:39.002                                                |
| File name      | listener.c                                                  |
| Message type   | EVENT:                                                      |
| Message string | do_G_Msg: rcp completed for<br>RRSDENADRDEN0.man.1029783689 |

#### 8.17.4 preprocessRRS.pl

The **preprocessRRS.pl** script preprocesses RRS data files containing surface observations for the LDAD text decoder. These data files are pulled across the security firewall from the external side and are stored on the internal side in the **\$LDAD\_DATA/tmp** directory. The file name uses the following convention: **RRS<station id><r><aaa><X>.<suffix>**, where:

- **RRS** is a data type identifier corresponding to those listed in the **LDADinfo.txt** file
- **<station id >** is the RRS station identifier (e.g., IAD for Dulles International Airport)
- **<r>** is the release number
- **<aaa>** is the ascension number (1–9)
- **<X>** is the transmission number during flight (A–Z)
- **<suffix>** identifies the type of product and is one of the following:
  - MAN
  - SGL
  - ABV
  - FZL
  - ULG

The **preprocessRRS.pl** script calls the **textdb** command line interface to store the product into the **fxatext** database.

The script enables WAN distribution of the processed files to the NCF. After the files are successfully disseminated over the WAN, the **preprocessRRS.pl** script moves the files from the **\$LDAD\_DATA/tmp** directory to the **\$FXA\_DATA/archive/obs/scratch** directory.

### ► To Access and Read the preprocessRRS Log

The **preprocessRRS** log resides on DX2 in a time-stamped directory under **\$LDAD\_INTERNAL\_LOGDIR**. As user **fxa**,

**TYPE:** `cd $LDAD_INTERNAL_LOGDIR/<yyyymmdd>`  
 ▪ Where **<yyyymmdd>** is today's date.

**TYPE:** `ps -ef |grep preprocessRRS`  
 ▪ Note the **preprocessRRS** PID.

**TYPE:** `ls -rtal preprocessRRS*`  
 ▪ Displays the latest **preprocessRRS** logs.

**NOTE:** The **preprocessRRS** log containing the PID of the **preprocessRRS** process is the current log.

**TYPE:** `tail -f <logname>`  
 ▪ Displays the log as it updates.

### Log Message Format

An entry at the beginning of the log looks similar to the following:

```
getFileExt(): Name of the file is: /data/fxa/LDAD/tmp/RRSDENADRDEN0.man
first 2 letters of the file extension are: ma
ARGV[0]: /data/fxa/LDAD/tmp/RRSDENADRDEN0.man
getAfosPil(): afos ID = DENADRDEN
storeInTextDB(): storeCommand =
textdb -w DENADRDEN < /data/fxa/LDAD/tmp/RRSDENADRDEN0.man
Successful storage to text database.
RouteProductFile() called on file: /data/fxa/LDAD/tmp/RRSDENADRDEN0.man
sendWanMessage();
getAfosPil(): afos ID = DENADRDEN
getFileHeader() from: RRSDENADRDEN.man
createAwipsID():
  Found match.
  awips ID = KBOUADRDEN

Preparing for WAN transmission...
AwipsId = KBOUADRDEN
wanHeader =TTAA97 KBOU 111200MANGJT
createTmpWanFile(): was successful...
```

```

WMO ID = KBOU
WAN command is  distributeProduct -a DEFAULTNCF KBOUADRDEN
/data/fxa/mhs/tmp/RRSDENADRDEN0.man
sendWanMessage(): successful submission...
removeTmpWanFile() was successful...
archiveobs():
moveFile(): /data/fxa/LDAD/tmp/RRSDENADRDEN0.man to
/data/fxa/archive/obs/scratch/RRSDENADRDEN0.man.20060512_133144
moveFile(): /data/fxa/LDAD/tmp/RRSDENADRDEN0.man moved successfully.
    Archival was successful...
Script Done ...

```

### 8.17.5 Reserved

### 8.17.6 distributeProduct

The **distributeProduct** process is a command-line interface to the **msg\_send** utility program. The **distributeProduct** process supports most command line options provided by **msg\_send**. The **distributeProduct** process instantiates a **MHSProduct** object that prepares the product for distribution and invokes the **msg\_send** program. The **createTmpWanFile** subroutine creates and opens a temporary file. Only the product from the original RRS file is extracted and written into the temporary file, excluding the two-line communications header. This copy of the data is passed to the **distributeProduct** command line interface. The **distributeProduct** process prepends the appropriate communications header to the product before distribution across the WAN to the NCF.

#### ► To Access and Read the distributeProduct Log

The **distributeProduct** log resides on PX2 in a time-stamped directory under **\$LOG\_DIR**. Perform the following commands as user **ldad**:

```

TYPE:      cd $LOG_DIR/<yyyymmdd>
               ■      Where <yyyymmdd> is today's date.

TYPE:      ls -ltr distributeProduct
               ■      Displays the latest distributeProduct logs.

TYPE:      tail -f <logname>
               ■      Displays the log as it updates.

```

#### Log Message Format

An entry at the beginning of the log looks similar to the following:

```

01:09:57.219 MHSProduct.C PROBLEM: Product
(/data/fxa/ispan/hydro/temp/A_format.974682596) is empty.
01:09:57.312 MHSProduct.C EVENT: Sending attachments
(/data/fxa/ispan/hydro/temp/A_format.974682596)

```

```

only. Attachments are assumed to contain correct communications header.
01:09:58.52 MHSPProduct.C EVENT: Product request (KSTORRZLDA) was successfully
submitted to the MHS request server for distribution.
  Message Attributes:
  Request ID: TBDW-32838
  To: DEFAULTINCF
  Priority: 0
  Type: Routine
  Subject:
  Handling Action: 0
01:09:58.529 MHSPProduct.C EVENT: TBDW-32838

```

The format of the log consists of the following fields:

```

Time stamp          01:09:58.528
File name           MHSPProduct.C
Message type        EVENT:
Message string      Product request (KSTORRZLDA) was successfully
                    submitted to the MHS request server for
                    distribution.

```

## 8.18 LDM Setup and Data Ingest Configuration

LDM is a software package that is designed to select, capture, process, and distribute data products using client/server programs. The LDM software is copyrighted by UCAR in Boulder, CO.

The LDM Package, version 6.11.2, was preinstalled on the LDM systems. This package needs to be configured for local site usage; therefore the LDM package was installed and configured in a generic manner.

Currently, the LDM package is not supported by the AWIPS Prime Contractor. Sites that require assistance in configuring LDM will need to contact their Regional LDM/AWIPS focal point or monitor the `ldad_x` (or `awipsinfo`) listserve for further information. Remember to COPY ALL changes made on LS2(LS3) to the other server since this cluster does not share hard drives. ALL changes made to one system must be copied to the other system. Below are the steps required to configure LDM.

### 8.18.1 LDM Setup

If a site needs to verify the configuration of `ldm`, perform the following steps:

```

TYPE:      ssh root@px2
TYPE:      ssh ls2
TYPE:      su - ldm
TYPE:      vi /usr/local/ldm/.bashrc

```

Verify that the following line exists in the file:

```
umask 002
```

Exit the file by typing: **esc :wq!**

Create the cron job for running the SCOUR cron. As user ldm perform the following:

**TYPE:** `vi /usr/local/ldm/etc/scour.conf`  
Edit the file for the desired scour frequency.

**TYPE:** `crontab -e`  
Verify the following line is in the file:  
`0 0,12 * * * /usr/local/ldm/bin/scour`  
Exit this file by typing: `esc :wq!`

**TYPE:** `vi /usr/local/ldm/etc/ldmadmin_pl.conf`  
(Verify fully qualified domain name. Example: `ls1-  
XXX.awips.noaa.gov`)

**TYPE:** `ldmadmin start`

If there are no errors and LDM is running on LS2(LS3), then repeat the above steps for the second server in the Linux cluster (LS3/LS2), but do not start ingest with the `ldmadmin start` command. You can copy the modified files to the other server in order to save time. `pqact.conf` will also need to be edited to identify which data to ingest. These files are discussed later in this section.

### 8.18.2 LDM Data Ingest Configuration

This is an overview of what needs to happen for successful ingest of data provided through LDM. The regional AWIPS Focal Point (AFP) should be able to provide more detailed assistance if needed.

1. The LDM software should have been setup on the LDAD servers when the new ls2 and ls3 cluster was installed. If LDM was not setup, perform the steps in the previous section.
2. Contact the Regional AWIPS Focal Point, for the IP address of the regional LDM server and its hostname. The AFP should also have information on how to get the necessary MADIS files for the desired products – through the region or from the MADIS ftp site.
3. ADD the regional LDM server IP address and hostname to the `/etc/hosts` file on both ls2 and ls3. If you don't add the IP address and hostname to the `/etc/hosts` file, you may not be able to connect to your regions LDM server.
4. Determine the LDM data types to ingest. The [MADIS](http://madis.noaa.gov) website, <http://madis.noaa.gov>, has information on what types of data is available.
5. Get the install instructions for the desired data (Instructions are available from MADIS or from your AFP) and configure the new product on the LDAD servers and the PX2 as required.



6. Make sure the new product is added to `/data/fxa/LDAD/data/LDADinfo.txt`
7. If LDM is configured properly on the LDAD servers, and the product is also configured properly, it should be available in CAVE at this point.

### 8.18.3 LDM Processes and Configuration Files

#### **ldmadmin-pl.conf**

The configuration files for LDM are located in `/usr/local/ldm/etc/`. The **ldmadmin** utility is a Perl script intended for high level administration of an LDM system. This utility is site configurable by editing **ldmadmin-pl.conf**. The **ldmadmin** utility is an excellent tool for monitoring and troubleshooting LDM. Examples are provided in a later section.

The **ldmadmin-pl.conf** file defines the fully qualifying domain name of your LDAD. For the ls2 and ls3 cluster, ls1 is the name of the cluster pair, and must be used as the fully qualifying domain name.

```
[ldm@ls2-ntcb etc]$ more ldmadmin-pl.conf
```

```
# The fully-qualified domain-name of the computer system.  If you have
to set
# this manually, then do the following:
#   1) Replace "your.hostname.here" in the following commented-out
statement
#       with the fully-qualified domain-name of the computer system;
#   2) Uncomment-out the same line by removing the leading hash (#)
character;
#       and
#   3) Comment-out the "chop" line by inserting a leading hash (#)
character.
#
# chop($hostname = `uname -n`);
$hostname = "ls1-ntcb.cr.awips.noaa.gov";
```

#### **Ldmd.conf**

The **ldmd.conf** file is a site configurable file that identifies the programs to run when LDM is started and which products to request from the regional LDM server. When configuring this file for a new LDAD product, only the *request* lines will be edited.

```
[ldm@ls2-ntcb etc]$ more ldmd.conf
```

```
#####
# $Id: ldmd.conf,v 1.9 1998/10/07 16:51:16 rkambic Exp $
# Sample ldmd.conf for ldm5
#####
#
# Programs that share a queue with rpc.ldmd
# are started by it and are in the same process group.
#
exec "pqexpire"
```

```

exec "pqbinstats"
exec "pqact"

#exec "pqsurf"
#exec "rtstats -h rtstats.unidata.ucar.edu"
#
# LDM5 servers request data
#
# request <feedset> <pattern> <hostname pattern>
#
request FSL ".*" ldm.crh.noaa.gov
request EXP ".*" ldm.crh.noaa.gov
request IDS ".*" ldm.crh.noaa.gov

```

The main program for LDM is called **rpc.ldmd**. It establishes an internet port for incoming connections, reads the **ldmd.conf** file and; executes all programs specified in the EXEC entries; forks an asynchronous copy of itself for each REQUEST entry. The **rpc.ldmd** program places the new data products in the *product-queue*.

#### 8.18.4 LDM Product-Queue

LDM uses a local data store called the product-queue, which is a memory mapped file that temporarily stores data products. The product queue typically holds about an hour's worth of data. The product queue is located in `/usr/local/ldm/data/ldm.pq`. Use the **pqcat** command as user `ldm` to view the product-queue.

The **pqact** program reads products from the *product-queue* and writes them to the `/data/Incoming` directory. The **pqact.conf** is a site configurable file for the **pqact** program. The **pqact.conf** configuration file tells the **pqact** utility how to handle the data products.

[ldm@ls2-ntcb etc]\$ **more pqact.conf**

```

####
# $Id: pqact.conf,v 1.8 1998/09/01 23:16:18 davis Exp $
#
# This is an example pqact.conf file,
# with some example entries commented out.
#
# The entries in this file control the local disposition
# of data. There is a whole chapter in the LDM Site Manager's
# Guide devoted to this file. We suggest you read and understand that
# material.
# http://www.unidata.ucar.edu/packages/ldm/ldm5/LDM5-44.html#HEADING44-0
...
# HIRESW
FSL5 (eastarw.*) FILE -overwrite /data/Incoming/\1
FSL5 (eastnmm.*) FILE -overwrite /data/Incoming/\1
FSL5 (westarw.*) FILE -overwrite /data/Incoming/\1
FSL5 (westnmm.*) FILE -overwrite /data/Incoming/\1
#
FSL5 ^(*GribF.*)

```

```

FILE -overwrite -close /data/Incoming/\1
#
EXP .*(GLERL.*)(\ .DAT)
FILE -overwrite /data/Incoming/\1.dat

```

When ldm data is received by ldad, it is temporarily stored in /data/Incoming until px2 (or px1 in failover) pulls the data into AWIPS. Once the ldm file is placed into /data/Incoming it is treated like all other LDAD data types (RRS, ASOS, River Gauge, etc...).

### 8.18.5 Useful LDM Commands

```

[ldm@ls2-ntcb etc]$ ldmadmin restart
Flushing the LDM product-queue to disk...
Stopping the LDM server...
Waiting for the LDM to terminate
The product-queue is OK.
/usr/local/ldm/etc/pqact.conf is syntactically correct
Starting the LDM server...
[ldm@ls2-ntcb etc]$

```

```

[ldm@ls2-ntcb etc]$ ldmadmin pqactcheck
/usr/local/ldm/etc/pqact.conf is syntactically correct
[ldm@ls2-ntcb etc]$

```

```

[ldm@ls2-ntcb etc]$ ldmadmin check
LDM status report from the logs for the last 744 hours.

Currently ls2-ntcb is running 0 percent idle
load average: 0.36, 0.73, 0.82
Running version number Unknown.
LDM was restarted 1 time(s)
      Last LDM restart at Jul 03 14:39:00

```

```

[ldm@ls2-ntcb etc]$ ldmadmin watch
(Type ^D when finished)
Aug 04 21:00:35 pqutil INFO: 9420 20080804210034.232 FSL5 000
LDAD.aws.AWS_dat
Aug 04 21:00:36 pqutil INFO: 3121 20080804210034.204 FSL5 000
LDAD.aws.AWS_dat
Aug 04 21:01:28 pqutil INFO: 3586 20080804210128.180 FSL5 000 LDAD.raw.dat
Aug 04 21:02:13 pqutil INFO: 1026 20080804210212.386 FSL5 000 LDAD.raw.dat

```

```

[ldm@ls2-ntcb etc]$ ldmadmin config

hostname:      ls2-tbw3.er.nws.noaa.gov
os:            Linux
release:       2.6.18-194.17.1.el5PAE
ldmhome:       /usr/local/ldm
bin path:      /usr/local/ldm/bin
conf file:     /usr/local/ldm/etc/ldmd.conf
log file:      /usr/local/ldm/logs/ldmd.log
numlogs:       7
log_rotate:    1
data path:     /usr/local/ldm/data

```

```

product queue: /usr/local/ldm/data/ldm.pq
queue size:    400M bytes
queue slots:   default
IP address:    all
port:          388
PID file:      /usr/local/ldm/ldmd.pid
LDMHOSTNAME:  ls2-tbw3.er.nws.noaa.gov
PATH:
/usr/local/ldm/bin:/bin:/usr/bin:/usr/sbin:/sbin:/usr/ucb:/usr/usb:/usr/
etc:/etc:/usr/local/ldm/decoders:/usr/local/ldm/util:/usr/local/ldm/bin:
/usr/lib/qt-3.3/bin:/usr/local/bin:/bin:/usr/bin:/usr/local/ldm/bin

```

```

[ldm@ls2-ntcb tmp]$ ldmadmin stop
Flushing the LDM product-queue to disk...
Stopping the LDM server...
Waiting for the LDM to terminate
[ldm@ls2-ntcb tmp]$ ldmadmin queuecheck
The product-queue is OK.
[ldm@ls2-ntcb tmp]$ ldmadmin start
The product-queue is OK.
/usr/local/ldm/etc/pqact.conf is syntactically correct
Starting the LDM server...

```

```

[ldm@ls2-ntcb ~]$ ldmping ldm.crh.noaa.gov
Feb 04 23:04:46 INFO:      State      Elapsed Port   Remote_Host
rpc_stat
Feb 04 23:04:46 INFO: Resolving ldm.crh.noaa.gov to 204.227.XXX.XXX took 0.00021
seconds
Feb 04 23:04:46 INFO: RESPONDING 0.006546 388   ldm.crh.noaa.gov

```

### 8.19 LDAD and PX2

As with all data that is placed in **/data/Incoming** on the LDAD server, LDM files are pulled into AWIPS by PX2 (or PX1 in failover).

- When the listener process on px2 copies the data from LDAD, it places the file into **/data/fxa/LDAD/tmp** where it will stay until processed.
- If a required preprocessor is not available or if there is no entry in either the **awips2afos.txt** or **afos2awips.txt**, the file will be moved to **/data/fxa/LDAD/Unknown**.
- If a preprocessor cannot process the file, it will be moved into the **/data/fxa/LDAD/Bad** directory.
- If the data is successfully decoded, a copy of the decoded file is placed in the **/data/fxa/LDAD/decoded** directory.

The preprocessor scripts for LDM data should be placed on the PX2 *and* PX1 according to the instructions provided by MADIS. Some data types *do not* require preprocessors.

**Note:** Contact your regional AWIPS Focal Point to find out how to get the install instructions and the preprocessors.

### 8.19.1 LDADinfo.txt

The LDADinfo.txt file specifies which preprocessor to call for a particular data type. When a new type of data is added to the ldm ingest, a preprocessor may be needed on the px2 (and on px1 for failover). The data and its preprocessor must be added to the **LDADinfo.txt** file unless otherwise stated in the MADIS documentation for that preprocessor.

```
[root@px2-ntcd ~]# cd /data/fxa/LDAD/data
```

```
[root@px2-ntcd ~]# more LDADinfo.txt
```

```
#data      netCDF|plot      LDAD      storage      preprocess
#type      .txt      dataKey    type        directory    script
#-----
SUA        |SUA      |256|257|CVS_TYPE|mesonet|preprocessSUA.pl|
RRS        |RRS      |256|256|CVS_TYPE|      |preprocessRRS.pl|
WAN_NWWS   |OUP      |256      |257|CVS_TYPE|mesonet|preProcessWAN_NWWS.pl
|
#mm5       |mm5      |87      |86|CVS_TYPE|mesonet|getAFile.csh      |
#testIPRCP|testIFLOWS|89      |90|CVS_TYPE|hydro  |testIFLOWS.pl      |
#testMESONET|testMESONET|87|86|CVS_TYPE|mesonet|testMESONET.pl      |
```

### 8.19.2 PX2 Log Files

The log files on PX2 (PX1 in failover) are in **/data/logs/ldad/<date>**.

```
[root@px2-ntcb ~]# cd /data/logs/ldad/(today's Date)
```

```
[root@px2-ntcb 20080128]# pwd
```

```
/data/logs/ldad/20080128
```

```
[root@px2-ntcb 20080128]# ls
```

```
CommsRouter9208px2-ntcb000004      routerLdadDecoder9240px2-ntcb003003
DataController9234px2-ntcb000004    routerShefEncoder9238px2-ntcb003006
distributeProduct                  routerStoreNetcdf9239px2-ntcb003004
listener                          routerStoreText9237px2-ntcb003005
listener8645px2-ntcb000009          watchDogInternal9269px2-ntcb000015
pollForData21712px2-ntcb000015
```

#### listener log file

- If a product was successfully copied from LDAD, you will see an event “rcp completed” for the data file.
- If a preprocessor was caller for the file, then a “Preprocessor Command Line” event will follow immediately after the “rcp completed” entry. Notice in the example below that the log file indicates which preprocessor was used against the data file.
- If a preprocessor is not used, there will *not* be a “Preprocessor Command Line” event. This only indicates that no preprocessor was required for the data file.

```
[root@px2-ntcb 20080128]# tail -f listener
23:06:41.752 listener.c EVENT: do_G_Msg: rcp completed for
mndotmet.dat.1201561601
23:06:41.755 listener.c EVENT: do_G_Msg: Preprocessor Command Line =
</awips/ldad/bin/preprocess_mndotmet.pl
/data/fxa/LDAD/tmp/mndotmet.dat.1201561601 px2f 15009>
...
...
23:06:42.146 listener.c EVENT: do_G_Msg: rcp completed for KYTC-
RWIS.dat.1201561601
23:06:42.156 listener.c EVENT: do_G_Msg: rcp completed for
NonFedAWOS.dat.1201561601
[root@px2-ntcb 20080128]#
```

### routerLdadDecoder log file

- The routerLdadDecoder log file indicates whether or not a product was successfully decoded.
- In most cases, if the file could not be decoded, a reason will be given.
- When a file fails to be decoded, the log file indicates that it was moved into the /data/fxa/LDAD/bad directory
- When a file is successfully decoded, the log file indicates that a copy of the file was moved to /data/fxa/LDAD/decoded and the decoded file was sent to the LDAD\_ROUTER

```
[root@px2-ntcb 20080229]# tail routerLdadDecoder9240px2-ntcb000053
00:45:33.107 LdadRoutines.C EVENT: Processing [1/1] = ddmnet.dat.1204245932
00:45:33.108 DecodeLdad.C PROBLEM: Unable to decode LDAD product!,
</data/fxa/LDAD/Raw/ddmnet.dat.1204245932>
00:45:33.108 LdadUtils.C EVENT: mv /data/fxa/LDAD/Raw/ddmnet.dat.1204245932
/data/fxa/LDAD/Bad/ddmnet.dat.1204245932
00:46:13.172 LdadRoutines.C EVENT: Processing [1/2] = AWS_KS.dat.1204245972
00:46:13.178 LdadRoutines.C EVENT: LdadRoutines::pingLdadRouter(),
'$LDAD_DECODED_DATA/ 1204245972.AWS_KS.decoded', sent to
LDAD_ROUTER
00:46:13.178 LdadRoutines.C EVENT: Processing [2/2] = AWS_MO.dat.1204245972
00:46:13.182 LdadRoutines.C EVENT: LdadRoutines::pingLdadRouter(),
'$LDAD_DECODED_DATA/ 1204245972.AWS_MO.decoded', sent to LDAD_ROUTER
```

## 8.20 LDAD Troubleshooting

### 8.20.1 LDAD Disk Removal

Unlike other disks in AWIPS, the LDAD disks are **COLD-Swap**. Never attempt to remove a disk while the server is powered on (green light on the power button). Use the following procedure to remove a disk:

1. Login as root into the server that the disk will be removed from (LS2 or LS3).
2. Type **shutdown -h** now
3. When the server is down, power off the LS. (Either the orange light or no light on the power switch is ok.)
4. Remove the drive from the LS by pushing on the red button and pulling on the black lever.

### 8.20.2 LDAD Server Disk Mirroring Procedure

The LDAD Servers contain two 80GB SATA hard drives and are configured for Raid 1 (Full Mirror). The disks are mirrored via the Raid Controller, which can be accessed at boot time. If a site needs to replace one of the two disks due to a failure, perform the following steps to break the mirror, install the new disk (power down first) and create the mirror:

1. Connect an external monitor and keyboard to the back of the LS server.
2. Reboot the system. During the System boot (not O.S. but firmware booting) the “ILO” configuration displays prompting the user to press F8. WAIT until the boot process goes to the next device boot which will be the RAID controller.
3. At the RAID controller boot, the user will again be prompted to press “F8”. NOW, press **F8** to enter the RAID controller setup menu.
4. The user will now have two options to select from at this Main Menu (*HP Embedded SATA Raid Controller*):

Array Configuration Utility

Disk Utility

5. Select **Array Configuration Utility**
6. User will be presented with a new menu listing 4 Options:

Manage Arrays

Create Arrays

Add/Delete Hot Spare

Configure Drives

7. Select **Manage Arrays**.

8. The array *00 Mirror Raid1 74.3GB* will be highlighted and options will be presented in the bottom left of the screen.
9. Press **Delete**. User will be presented with a Pop-Up window (“Array Properties”) querying the user with the following:
  - Delete
  - Cancel
10. Select **Delete** and press **Enter**.
11. User will be presented with another popup window (*Yes/No*): Type **y** and press return.
12. User will be presented with a new window (*Deleting Information*) with the following options:
  - [none] [member #0] [member #1] [Both]
13. Select **None** and press **Enter**.
14. User is presented with the status message *No Arrays Present* – Press any key to continue. Press the **space bar**. The Menu seen in step 6 returns.
15. Press **Esc** to exit to the Main Menu seen in step 4.
16. Press the **Esc** key to exit the configuration utility. User will be prompted with a *Yes/No* box to confirm exiting. Select **Yes** to exit back to the boot-up cycle of the server.
17. The server will begin to reboot – press the **Power Off** button immediately to power down the system.
18. Remove the defective hard drive and insert the replacement hard drive.
19. Power on the system.
20. Monitor the boot sequence and Press **F8** at the Raid configuration prompt.
21. Select **Array Configuration Utility** at the Main Menu.
22. Select **Add/Delete Hotspare** at the following Menu.
23. A status window indicating the drives and their status displays. Select the drive that was replaced. Drive 00 is the drive to the far left when facing the server. Drive 01 is the drive to the right. The status window will indicate the new drive by showing detailed status and disk drive specifications.
24. Command options will be displayed in the bottom left of the screen. Press the **<INS>** key to select the drive highlighted.
25. Press **Enter** to complete the selection.
26. User will be prompted with *Do you want to create a spare? (Yes/No)*: type **y**
27. User will be returned to the previous menu as seen in step 5. Select **Manage Arrays**.



28. The highlighted array will be *00 mirror RAID1 74.3GB*. Command options will be displayed in the bottom left of the screen.
29. Press **Ctrl+R** to rebuild the array.
30. The new disk is now being populated. Time to complete is approximately 45 minutes.
31. When done, the message *Building the array is successfully completed* displays – Press any key to continue. Press the **space bar** to continue.
32. Press the **Esc** key to exit to the Main Menu.
33. Press the **Esc** key to exit the configuration utility. Select/enter **Yes** to continue exiting. The system will now reboot. Monitor the boot process. The Raid Controller should indicate that TWO physical drives are present and that ONE logical drive is present/configured. If this is the case, then the system is configured properly.

This completes the LDAD Server Disk Mirroring Procedure/Setup.

### 8.20.3 Fax Modem Troubleshooting

As with all data that is placed in /data/Incoming on the LDAD server, LDM files are pulled into AWIPS by PX2 (or PX1 in failover).

If there seems to be a problem with the fax queue filling up with unsent faxes, run the **faxstat** command on the active LS. It's a good sign if the fax queue status is *Running and idle* or *Initializing server* or something like *Sending job 13....* However, it's likely a bad sign if the fax queue status is **Waiting for modem to come ready...**

Sometimes even in normal operation the *Waiting for modem to come ready* message appears, but if the status line does not change even after several minutes, the modem could probably use a power-cycling. Switch it off, wait about 30 seconds, then switch it back on. Then run **service heartbeat restart** on the active LS, wait a minute or so for heartbeat to reset itself, and the faxes should start running again. Running faxstat now should give one of the acceptable messages rather than "Waiting for modem to come ready."

Check the fax modem dip switch settings (MultiTech Fax Modem):

```
Switch:  1  2  3  4  5  6  7  8  9 10 11 12 13 14 15 16
Position: U  U  D  U  U  U  D  D  D  U  D  D  U  U  D  D
```

If switch settings were changed, power cycle the modem by turning the power switch off and then on.

# **Chapter 9**

## **Background Applications**

## Chapter 9. Background Applications

### Table of Contents

|                                                                                    | <i>Page</i> |
|------------------------------------------------------------------------------------|-------------|
| 9.1 Climatological Reports Formatters for NWS and NWWS .....                       | 1           |
| 9.1.1 Configuration Files and Environment Variables .....                          | 1           |
| 9.1.2 hmdb Database Tables .....                                                   | 4           |
| 9.1.3 Processes .....                                                              | 5           |
| 9.1.4 GUIs .....                                                                   | 16          |
| 9.1.5 Climatological Reports Formatter Setup .....                                 | 21          |
| 9.1.5.1 Configure Global Climate Parameters .....                                  | 21          |
| 9.1.5.2 Establishing the Historical Database.....                                  | 23          |
| 9.1.5.2.1 Entering Historical Data Manually.....                                   | 23          |
| 9.1.5.2.2 Importing the Data.....                                                  | 32          |
| 9.1.5.3 Configuring Products.....                                                  | 36          |
| 9.1.5.3.1 Report Type, Report Configuration, Select Stations for<br>Product.....   | 39          |
| 9.1.5.3.2 Weather Elements.....                                                    | 40          |
| 9.2 Record Climate.....                                                            | 44          |
| 9.2.1 Configuration Files and Environment Variables .....                          | 45          |
| 9.2.2 Processes .....                                                              | 46          |
| 9.3 Hourly Weather Roundup Formatter for the NOAA Weather Wire Service (NWWS)..... | 57          |
| 9.3.1 Configuration Files and Environment Variables .....                          | 58          |
| 9.3.2 Processes .....                                                              | 60          |
| 9.3.3 Setting up the HWR NWWS Application .....                                    | 66          |
| 9.3.3.1 Identifying the Products to be Produced .....                              | 66          |
| 9.3.3.2 Setting Up the HWR NWWS Application .....                                  | 66          |
| 9.3.3.3 Creating a Station List.....                                               | 69          |
| 9.3.3.4 Updating Station PILs.....                                                 | 72          |
| 9.3.3.5 Treatment of Missing Data .....                                            | 74          |
| 9.4 Hourly Weather Roundup Formatter for the NOAA Weather Radio .....              | 75          |
| 9.4.1 Configuration Files and Environment Variables .....                          | 76          |
| 9.4.2 Processes .....                                                              | 77          |
| 9.4.3 Setting Up the HWR NWR Application.....                                      | 88          |
| 9.4.3.1 Identifying the Products to be Created.....                                | 88          |
| 9.4.3.2 Selecting the HWR NWR GUI Options .....                                    | 88          |
| 9.4.3.3 Creating a Station List.....                                               | 91          |

|           |                                                               |     |
|-----------|---------------------------------------------------------------|-----|
| 9.4.3.4   | Creating a Broadcast Format File .....                        | 99  |
| 9.4.3.5   | Creating a Default Format File .....                          | 108 |
| 9.4.3.6   | Providing Additional Variability for the NWR Broadcasts ..... | 110 |
| 9.4.3.7   | Treatment of Missing Data .....                               | 114 |
| 9.4.3.8   | Cautions .....                                                | 115 |
| 9.5       | Aviation Forecast Preparation System.....                     | 116 |
| 9.5.1     | System Overview .....                                         | 116 |
| 9.5.1.1   | Name and Event Server.....                                    | 116 |
| 9.5.1.2   | Data Ingest Server .....                                      | 118 |
| 9.5.1.3   | Data Request Server.....                                      | 118 |
| 9.5.1.4   | Transmission Server.....                                      | 119 |
| 9.5.1.5   | Client Programs .....                                         | 120 |
| 9.5.2     | Configuring AvnFPS .....                                      | 120 |
| 9.5.2.1   | Files in etc .....                                            | 121 |
| 9.5.2.2   | TAF Configuration Files.....                                  | 130 |
| 9.5.2.3   | TWEB Configuration Files.....                                 | 138 |
| 9.5.2.4   | X Resources Configuration Files .....                         | 138 |
| 9.5.2.5   | Climatological Data .....                                     | 141 |
| 9.5.3     | Starting and Stopping AvnFPS .....                            | 142 |
| 9.5.3.1   | Starting AvnFPS Servers .....                                 | 142 |
| 9.5.3.2   | Stopping AvnFPS Servers.....                                  | 144 |
| 9.5.4     | Avnsetup .....                                                | 145 |
| 9.5.4.1   | Editing Monitoring Rules .....                                | 146 |
| 9.5.4.2   | Editing AvnFPS TAF Site Information .....                     | 148 |
| 9.5.4.3   | Editing AvnFPS TAF Site Templates.....                        | 150 |
| 9.5.4.4   | Editing AvnFPS TAF Product Definition.....                    | 151 |
| 9.5.4.5   | Editing TWEB Route Information using AvnFPS.....              | 152 |
| 9.5.4.6   | Editing the AvnFPS TWEB Route Template .....                  | 153 |
| 9.5.4.7   | Editing TWEB Product Definition using AvnFPS .....            | 154 |
| 9.5.4.8   | Creating AvnFPS Database Triggers .....                       | 155 |
| 9.5.4.9   | Using the AvnFPS Text Editor .....                            | 156 |
| 9.5.5     | Configuring IFPS to Send Gridded Data to AvnFPS.....          | 158 |
| 9.5.6     | Logging .....                                                 | 158 |
| 9.5.7     | AvnFPS Troubleshooting.....                                   | 160 |
| 9.5.7.1   | Overall AvnFPS Server Health.....                             | 160 |
| 9.5.7.1.1 | Diagnostic Tools.....                                         | 160 |
| 9.5.7.2   | Log Files .....                                               | 161 |

|           |                                              |     |
|-----------|----------------------------------------------|-----|
| 9.5.7.3   | Data Ingest .....                            | 162 |
| 9.5.7.3.1 | Data Ingest Troubleshooting .....            | 162 |
| 9.5.7.3.2 | Specific Hints for Specific Data Types ..... | 162 |
| 9.5.7.4   | Product Transmission.....                    | 163 |
| 9.6       | NOAA Weather Radio Editor.....               | 163 |
| 9.6.1     | NWR Editor Setup and Configuration.....      | 164 |
| 9.6.2     | NWR Editor Event Logging .....               | 165 |
| 9.6.3     | The NWR Editor GUI.....                      | 167 |
| 9.6.4     | NWR Editor Application Design Overview ..... | 170 |

### **List of Exhibits**

|                    |                                                                                      |     |
|--------------------|--------------------------------------------------------------------------------------|-----|
| Exhibit 9.1.3-1.   | Climatological Reports Formatter for NWR and NWWS (Daily).....                       | 7   |
| Exhibit 9.1.3-2.   | Climatological Reports Formatter for NWR and NWWS<br>(Monthly/Seasonal/Annual) ..... | 8   |
| Exhibit 9.2.2-1.   | Record Climate Data Flow .....                                                       | 47  |
| Exhibit 9.3.2-1.   | Hourly Weather Roundup Formatter for NOAA Weather Wire Service.....                  | 61  |
| Exhibit 9.3.3.2-1. | The Hourly Weather Roundup GUI.....                                                  | 66  |
| Exhibit 9.4.2-1.   | Hourly Weather Roundup Formatter for NOAA Weather Radio.....                         | 78  |
| Exhibit 9.4.3.3-1. | Sample Station List for the NWR .....                                                | 92  |
| Exhibit 9.4.3.3-2. | Symbolic Words for Use in Comment Lines.....                                         | 93  |
| Exhibit 9.4.3.4-1. | Sample Broadcast Format File for NWR.....                                            | 100 |
| Exhibit 9.4.3.4-2. | Symbolic Text for Use in Broadcast Format Files.....                                 | 101 |
| Exhibit 9.4.3.5-1. | Sample Default Format File.....                                                      | 108 |
| Exhibit 9.5.1-1.   | Data Flow Diagram.....                                                               | 117 |
| Exhibit 9.5.4-1.   | avnsetup Main GUI.....                                                               | 145 |
| Exhibit 9.5.4.1-1. | AvnFPS Monitoring Criteria Editor .....                                              | 146 |
| Exhibit 9.5.4.2-1. | AvnFPS TAF Site Info Editor .....                                                    | 149 |
| Exhibit 9.5.4.4-1. | AvnFPS TAF Product Configuration Editor .....                                        | 151 |
| Exhibit 9.5.4.5-1. | AvnFPS TWEB Route Info Editor .....                                                  | 152 |
| Exhibit 9.5.4.7-1. | TWEB Product Configuration Editor .....                                              | 154 |
| Exhibit 9.5.4.8-1. | AvnFPS Trigger Editor .....                                                          | 156 |
| Exhibit 9.5.4.9-1. | AvnFPS Setup Editor.....                                                             | 157 |
| Exhibit 9.5.4.9-2. | AvnFPS Text Editor Dialog.....                                                       | 157 |
| Exhibit 9.6.2-1.   | Sample NWR Editor nwrWish Log File Where debug=on .....                              | 166 |
| Exhibit 9.6.2-2.   | Sample sendToNWR logStreamExpect Log File .....                                      | 167 |
| Exhibit 9.6.3-1.   | NWR Editor GUI Access.....                                                           | 168 |
| Exhibit 9.6.3-2.   | The NWR EditorGUI.....                                                               | 169 |

Exhibit 9.6.4-1. NWR Editor Application Structure High-Level Design Overview ..... 171  
Exhibit 9.6.4-2. NWR Editor Application Structure – System View ..... 172

### **List of Tables**

Table 9.1.1-1. Environment Variables in CLIMATE ..... 1  
Table 9.1.4-1. Climate GUIs and Corresponding Executables ..... 16  
Table 9.1.5.3-1. Default Annual Periods ..... 38  
Table 9.2.1-1. Environment Variables in Record Climate..... 45  
Table 9.5.1.2-1. avndis Threads ..... 118  
Table 9.5.4.2-1. AvnFPS TAF Site Info Editor Fields and Descriptions..... 149  
Table 9.5.4.5-1. AvnFPS TWEB Route Info Editor Fields and Descriptions ..... 153  
Table 9.6.1-1. File Format for the nwr.cfg File ..... 164  
Table 9.6.1-2. Environment Variables for the NWR Editor ..... 165

The AWIPS Background Applications are a set of applications that are designed to run unattended in the background after a manual initialization of data. Some of the applications can also be executed manually. Once the applications are set up, they run independently and only need to be monitored.

The AWIPS Background Applications currently consist of the following:

- Climatological Reports Formatters for the NOAA Weather Radio (NWR) and Weather Wire Service (NWWS)
- Record Climate
- Hourly Weather Roundup Formatter for NWR and NWWS
- Aviation Forecast Preparation System (AvnFPS)
- NOAA Weather Radio Editor.

The main data flow and setup of each application is described in the following sections.

## 9.1 *Climatological Reports Formatters for NWS and NWWS*

The morning, intermediate, and evening Climatological Reports Formatter creates daily climatological reports for AWIPS. These reports summarize one or more stations' daily weather observations, records, normals, departures from normal, and last year's values for that date. The Monthly, Seasonal, and Annual Climatological Reports Formatters are used to summarize one or more stations' monthly, seasonal, or annual weather observations, records, normals, departures from normal, and last year's value for the period. The formatters prepare tabular products to be disseminated over the NWWS and voice-ready products for NWR broadcast. The F6 formatter creates a month-to-date report containing climatological information that can be displayed on Web pages.

The Climate program provides the forecaster with the capability to set up and initialize output products; import climatology data; review and modify input observations; create, review, and modify the output values; and format the Climatological Reports.

### 9.1.1 *Configuration Files and Environment Variables*

Table 9.1.1-1 shows the environment variables used in discussing the Climatological Reports Formatter. Variables are defined for the **fxa** user and individual user accounts.

**Table 9.1.1-1. Environment Variables in CLIMATE**

| Environment Variable Name | Environment Variable Path |
|---------------------------|---------------------------|
| CLIMATE_DIR               | /awips/adapt/climate      |
| FXA_DATA                  | /data/fxa                 |
| LOG_DIR                   | /data/logs/fxa            |

## Configuration Files

Most of the following files reside in **\$CLIMATE\_DIR/data**.

|                                                                  |                                                                                                                                                                                                                                                                                                                                                                                                                                                                                                                                                                                                                                 |
|------------------------------------------------------------------|---------------------------------------------------------------------------------------------------------------------------------------------------------------------------------------------------------------------------------------------------------------------------------------------------------------------------------------------------------------------------------------------------------------------------------------------------------------------------------------------------------------------------------------------------------------------------------------------------------------------------------|
| <b>clibrwse.conf</b>                                             | This file contains the path and command to start the NWR Browser Graphical User Interface (GUI), the destination directory path for the NWWS climate products, and the path and command for the script to transfer the products to the NWR Browser or the Console Replacement System (CRS).                                                                                                                                                                                                                                                                                                                                     |
| <b>clinwws.conf</b>                                              | This file contains the path and command to transfer the climate products to the NWWS and the destination directory for the NWWS climate products.                                                                                                                                                                                                                                                                                                                                                                                                                                                                               |
| <b>control_am/im/pm</b>                                          | These are the default control files used by the <b>do_all_climate</b> , <b>create_climate</b> , and <b>display_climate</b> processes. These files contain the starting and ending reporting periods for the cooling, heating, and snow seasons for the corresponding morning, intermediate, and evening reports. They also contain instructions on whether to include the various daily climatological elements (e.g., maximum temperature during month, maximum wind speed during month) and their dates of occurrence, sunrise and sunset times, and the minimum and maximum daily temperatures and records, and their dates. |
| <b>control_am/im/pm/<br/>mon/sea/ann_<br/>&lt;product id&gt;</b> | These files, which correspond to the morning, intermediate, evening, monthly, seasonal, and annual reports, contain the specific reporting periods and formatting instructions for a specific product.                                                                                                                                                                                                                                                                                                                                                                                                                          |
| <b>control_mon/sea/ann</b>                                       | These are the default control files used by the <b>do_all_climate</b> , <b>create_climate</b> and <b>display_climate</b> processes. They contain the starting and ending reporting periods for the cooling, heating, and snow seasons, as well as instructions on whether to include the various monthly climatological elements (e.g., maximum temperature, average wind speed), their dates of occurrence, normals and departures from normal records, their dates of occurrence, and last year's values and dates of occurrence.                                                                                             |
| <b>data_am/im/pm</b>                                             | These files contain the date, number of observation stations, and the climatological data generated by the <b>create_climate</b> and <b>display_climate</b> processes. The <b>display_climate</b> process reads and updates these files. The files are also used by the <b>format_climate</b> process.                                                                                                                                                                                                                                                                                                                          |



|                                                                  |                                                                                                                                                                                                                                                                                                                                                                                              |
|------------------------------------------------------------------|----------------------------------------------------------------------------------------------------------------------------------------------------------------------------------------------------------------------------------------------------------------------------------------------------------------------------------------------------------------------------------------------|
| <b>data_mon/sea/ann</b>                                          | These files contain the date, number of observation stations, and the climatological data generated by <b>create_climate</b> . The <b>display_climate</b> process both reads and updates these files. They are also used by <b>format_climate</b> .                                                                                                                                          |
| <b>gif and html files</b>                                        | These help files discuss the setup, review and editing of input values, execution of the Climate program, and the review and editing of the output products.                                                                                                                                                                                                                                 |
| <b>global_day</b>                                                | This file contains the variables that affect the climate application globally: the valid times for intermediate and evening summaries; NWS product formatting options; and threshold values for temperature, precipitation, and snowfall. It is edited by <b>set_up_climate</b> and used by <b>create_climate</b> , <b>display_climate</b> , <b>format_climate</b> , and <b>qc_climate</b> . |
| <b>header_am/im/pm/month/sea/ann_&lt;product id&gt;</b>          | This file contains the specific dissemination and transmission instructions for a specific product.                                                                                                                                                                                                                                                                                          |
| <b>header_default</b>                                            | This file contains the default header information displayed in the NWR and NWS configuration GUIs in the <b>set_up_climate</b> process. This information includes the effective, expiration, and creation date and time.                                                                                                                                                                     |
| <b>history_am/im/pm</b>                                          | These files contain the date, number of stations, and historical data from the <b>climate_day_norm</b> and <b>climate_mon_norm</b> data tables. These files are generated by the <b>create_climate</b> process and used by the <b>format_climate</b> process.                                                                                                                                |
| <b>history_mon/sea/ann</b>                                       | These files contain the date, the number of stations, and the historical data from the <b>mon_climate_norm</b> data table. These files are generated by <b>create_climate</b> and used by <b>format_climate</b> .                                                                                                                                                                            |
| <b>info_am/im/pm</b>                                             | These files contain the non-meteorological data generated by the <b>create_climate</b> process and used by the <b>format_climate</b> process. The files contain valid time, number of stations, and the sunrise and sunset times for each station.                                                                                                                                           |
| <b>output_am/im/pm/month/sea/ann_&lt;product id&gt;.nwr/nwsw</b> | These are output files associated with a specific product generated by <b>format_climate</b> . Files with the suffix “ <b>nwr</b> ” are CRS products and files with the suffix “ <b>nwsw</b> ” are NOAA Weather Wire Service products. Each output file is associated with a unique product ID.                                                                                              |

|                                                          |                                                                                                                                                                                                                                                                                                                                                                                                                                                                                                                                                                                                                                                                                                                                                                                                                                                                                                                                                           |
|----------------------------------------------------------|-----------------------------------------------------------------------------------------------------------------------------------------------------------------------------------------------------------------------------------------------------------------------------------------------------------------------------------------------------------------------------------------------------------------------------------------------------------------------------------------------------------------------------------------------------------------------------------------------------------------------------------------------------------------------------------------------------------------------------------------------------------------------------------------------------------------------------------------------------------------------------------------------------------------------------------------------------------|
| <b>station_am/im/pm/month/sea/ann_&lt;product id&gt;</b> | This file contains station information such as the station name, four-character METAR station identifier, UTC offset, and latitude and longitude. This file is used by the <b>format_climate</b> process and links one or more stations with a specific product.                                                                                                                                                                                                                                                                                                                                                                                                                                                                                                                                                                                                                                                                                          |
| <b>wait_timex.txt</b>                                    | This file consists of two values – the data wait time and the product wait time.<br><br><b>DATA_WAIT_TIME</b> defines the amount of time the <b>display_climate</b> program will wait after notifying the user to review data before continuing. If the user acknowledges the alert, the <b>edit_daily_climate</b> is displayed; this provides an opportunity to review and correct the data. If the user fails to acknowledge the alert, the derived parameters are calculated and stored in the database and the execution continues.<br><br><b>PRODUCT_WAIT_TIME</b> defines the amount of time execution will wait after alerting the user. This provides an opportunity to review the NWR product prior to sending the output to the CRS. If the user fails to acknowledge the alert, the product is automatically sent to the CRS. If the user acknowledges the alert, the NWR browser is displayed, which enables the user to review NWR products. |

### 9.1.2 *hmdb Database Tables*

These database tables are created or modified when Set Up Climate Runs is completed in its entirety. Refer to Section 9.1.3 for more information on initial climate setup.

|                          |                                                                                                                                                                                                                                                                                               |
|--------------------------|-----------------------------------------------------------------------------------------------------------------------------------------------------------------------------------------------------------------------------------------------------------------------------------------------|
| <b>cli_asos_daily</b>    | This holds the decoded values from ASOS Daily Summary Messages. The <b>create_climate</b> process checks this table before checking the METAR records when determining daily climate values.                                                                                                  |
| <b>cli_asos_monthly</b>  | This holds the decoded values from ASOS Monthly Summary Messages. The <b>create_climate</b> process checks this table before checking the METAR records when determining monthly climate values.                                                                                              |
| <b>cli_freezedates</b>   | This holds the earliest, latest, normal, record, and last year's freeze dates. It is updated by <b>display_climate</b> and used by <b>create_climate</b> and <b>format_climate</b> .                                                                                                          |
| <b>cli_mon_season_yr</b> | This table consists of monthly, seasonal, and annual climatological data for several stations. These data are created by the <b>create_climate</b> program and displayed by the <b>display_climate</b> program. Data in this table can be viewed and edited by the <b>qc_climate</b> program. |

|                           |                                                                                                                                                                                                                                                                   |
|---------------------------|-------------------------------------------------------------------------------------------------------------------------------------------------------------------------------------------------------------------------------------------------------------------|
| <b>cli_sta_product</b>    | This holds the climate product identifier and station identifier. It is created by <b>set_up_climate</b> and used by <b>create_climate</b> and <b>format_climate</b> .                                                                                            |
| <b>cli_sta_setup</b>      | This holds station information such as the database identifier, name, and latitude and longitude. This table is established by the <b>set_up_climate</b> program.                                                                                                 |
| <b>climate_day_config</b> | This consists of the product identifier and time of day. These data are created by the <b>set_up_climate</b> program and used by the <b>format_climate</b> program.                                                                                               |
| <b>climate_period</b>     | This holds the beginning and ending years of the normals and extremes climate data period of record. This table is used by the <b>init_climate</b> program.                                                                                                       |
| <b>climo_dates</b>        | This holds beginning and ending dates for reporting snowfall and precipitation. It is created by <b>set_up_climate</b> and used by <b>create_climate</b> and <b>format_climate</b> .                                                                              |
| <b>daily_climate</b>      | This table consists of daily climatological data for each station. These data are created by the <b>create_climate</b> program and displayed by the <b>display_climate</b> program. Data in this table can be viewed and edited by the <b>qc_climate</b> program. |
| <b>day_climate_norm</b>   | This holds daily historical climatology such as temperature, precipitation, snow, and heating/cooling degree day data. This table is established by the <b>init_climate</b> program and used by the <b>create_climate</b> program.                                |
| <b>fss_report</b>         | This contains identifying information on decoded METAR and SCD reports that is used by the <b>create_climate</b> program.                                                                                                                                         |
| <b>mon_climate_norm</b>   | This holds monthly climatology such as temperature, precipitation, snow, and heating/cooling degree day normals, means, and extremes. It is established by the <b>init_climate</b> program and used by the <b>create_climate</b> program.                         |
| <b>rpt</b>                | The <b>MetarDecoder</b> decodes these hourly observational records. They are used as input to the <b>create_climate</b> program.                                                                                                                                  |
| <b>station_location</b>   | This holds information about the climatological station (e.g., station identifier, elevation, name). It is installed at site start-up and used by the <b>set_up_climate</b> program.                                                                              |

### 9.1.3 Processes

When the Climate applications are initiated from the GUI, all processes run on the workstation.

LX do\_all\_climate  
LX set\_up\_climate  
LX init\_climate  
LX qc\_climate  
LX **build\_f6**  
PX1 **ASOS\_smDecoder**  
LX create\_climate  
LX display\_climate  
LX format\_climate

Refer to Exhibits 9.1.3-1 and 9.1.3-2 for the Climatological Reports Formatter for NWR and NWWS data flow diagrams for Daily, Monthly, Seasonal, and Annual. Refer to Section 9.1.4 for more details on any mentioned GUIs.

The following processes are located at this path: \$CLIMATE\_DIR/bin/Linux.

**do\_all\_climate** The **do\_all\_climate** process launches the **Climate Master Menu**. The forecaster may elect to initiate programs to configure climate parameters, set up/edit climate products, execute the climatological formatters, create the F6 product, and initialize and “quality control” the climate database tables from the **Climate Master Menu**. The **do\_all\_climate** program launches the scripts that initiate the forecaster-selected programs.

**set\_up\_climate** The **set\_up\_climate** process controls configuration of the Climate program and its execution. This process enables the forecaster to choose and update the stations for which climatological summaries are produced, and to configure the output products for the morning, intermediate, and evening climate summaries. Configuring the output products includes setting or selecting the product identifiers and parameters that control the dissemination of NWR and NWWS products (e.g., periodicity, effective and expiration time, and listening area codes), the stations to be included in an individual product, and the content summary’s format and content.

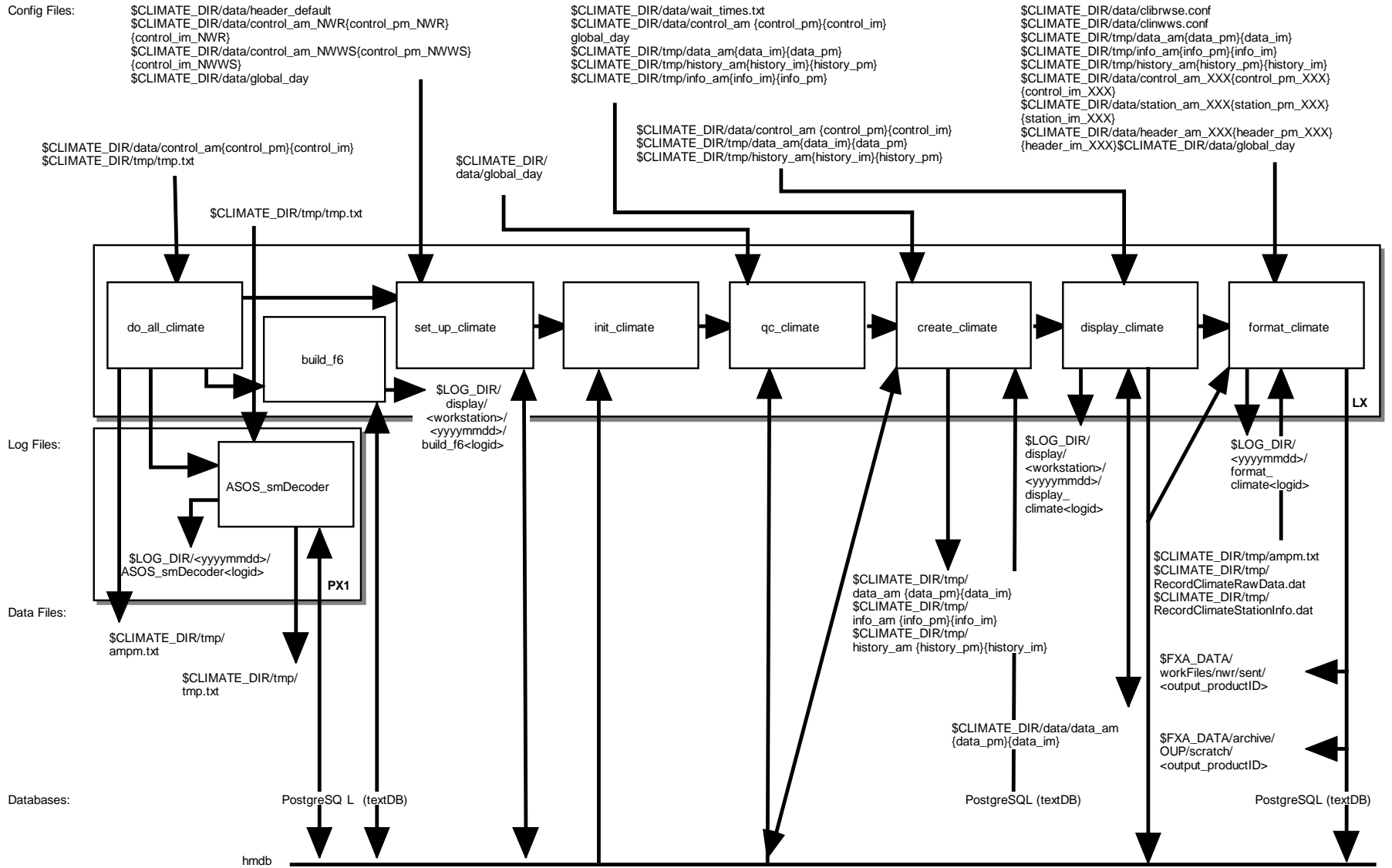

SMM 07/19/1C

**Exhibit 9.1.3-1. Climatological Reports Formatter for NWR and NWWS (Daily)**

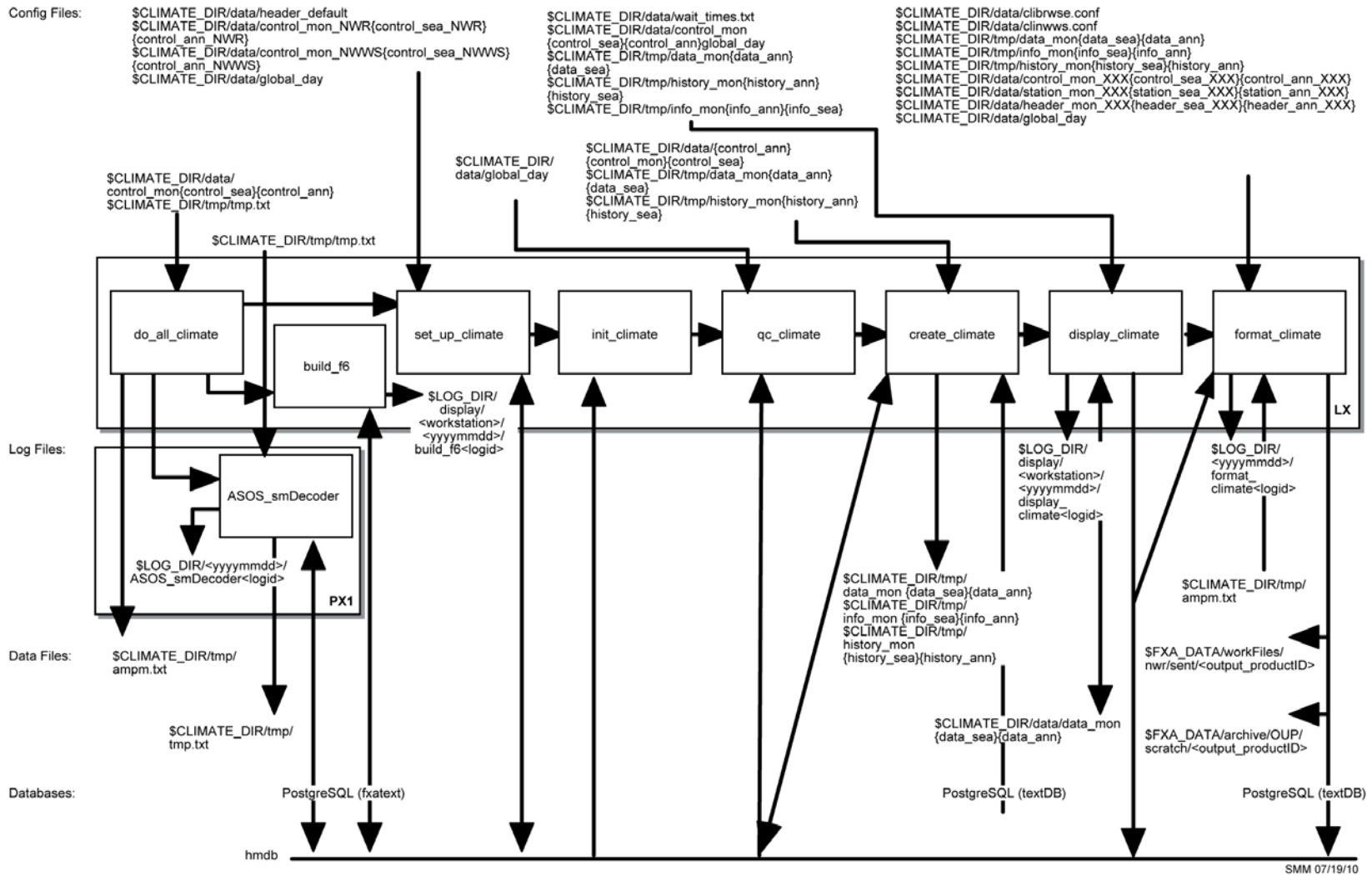

Exhibit 9.1.3-2. Climatological Reports Formatter for NWR and NNWS (Monthly/Seasonal/Annual)

**init\_climate**

This program establishes, edits, and updates the historical climate database contained in the tables **day\_climate\_norm** and **mon\_climate\_norm** in the **hmdb** database. The **init\_climate** process can also be used to view the historical data after the data have been entered. The historical climate database consists of daily, monthly, seasonal, and annual normals, extreme values, and the years in which extreme values were observed. These data can be manually entered using the five GUIs: Climatology Normals, Means, Extremes; the Daily Normals, Means, Extremes; the Monthly Normals, Means, Extremes; Seasonal Normals, Means, Extremes; and Annual Normals, Means, Extremes.

The morning climate program automatically updates the database when new records have been set.

**qc\_climate**

The **qc\_climate** process enables the forecaster to review and modify stored observations in the tables **daily\_climate** and **cli\_mon\_season\_yr** in the **hmdb** database. One GUI is provided for this purpose: the **Edit Climatological Data GUI** (refer to Section 9.1.4 for GUI information). The forecaster can also use the **qc\_climate** process to fill in holes in the climate database.

**build\_f6**

This program produces F6 products containing the climatological data for all stations for any requested month provided data are present in the daily climate database. The product includes the daily temperature, humidity, and wind extremes as well as the accumulated totals of precipitation, snow, and degree days.

The **create\_f6\_product** script generates the F6 products for the Climate program. It sets the paths to the given directories, changes the working directory to the temporary climate directory, executes the **build\_f6** process, copies the **output\_f6** files into the **data** directory, and removes all temporary files from the **tmp** directory.

The **build\_f6** process controls the building of the daily F6 report. It gets the stations from the climate station table and the current local execution date, and it builds the report through the day before.

► **To View the Current Day's build\_f6 Log**

As user fxa or your individual user account on any workstation,

**TYPE:**        `cd $LOG_DIR/display/<display>/<yyyymmdd>`

- Where **<yyyymmdd>** is today's date and **<display>** is the current display variable (e.g., lx3-tbdw:0).

**TYPE:** `ls -ltr build_f6*`

- Displays the current day's **build\_f6** logs from earliest to latest.

**TYPE:** `tail -f <logname>`

- Displays the latest registered messages as the log updates.

### Log Message Format

An entry in the log should look like the following:

```
build_f6 6387 974842165.042823 21:29:25.042 EVENT:
build element: missing value returned for SUM(snow)
for station 17890 period start 2006-05-01 period end 2006-05-11
database return code 0
build_f6 6387 974842165.074418 21:29:25.074 EVENT:
build element: missing value returned for SUM(snow)
for station 17890 period start 2006-05-01 period end 2006-05-11
database return code 0
build_f6 6387 974842165.115442 21:29:25.115 EVENT:
return multiple rows: missing value returned for max_wind_spd number 3
for station 17890 period start 2006-05-01 period end 2006-05-11
database return code 100
build_f6 6387 974842165.141399 21:29:25.141 EVENT:
return multiple rows: missing value returned for max_gust_spd number 2
for station 17890 period start 2006-05-01 period end 2006-05-11
database return code 100
build_f6 6387 974842165.141945 21:29:25.141 EVENT:
return multiple rows: missing value returned for max_gust_spd number 3
for station 17890 period start 2006-05-01 period end 2006-05-11
database return code 100
build_f6 6387 974842165.181658 21:29:25.181 EVENT:
return element dates: missing value returned for max_temp date 1
for station 17890 period start 2006-05-01 period end 2006-05-11
database return code 100
```

The log consists of the following fields:

|                |                                                                                                                                                                    |
|----------------|--------------------------------------------------------------------------------------------------------------------------------------------------------------------|
| Time stamp     | 21:29:25.181                                                                                                                                                       |
| Module name    | build_f6 6387 974842165.181658                                                                                                                                     |
| Message type   | EVENT:                                                                                                                                                             |
| Message string | return element dates: missing value returned<br>for max_temp date 1 for station 17890 period<br>start 2006-05-01 period end 2006-05-11 database<br>return code 100 |

### ASOS\_smDecoder

The **ASOS\_smDecoder.sh** script executes the **ASOS\_smDecoder** process, which decodes the ASOS daily or monthly summary messages for climate data. The **ASOS\_smDecoder** uses the **ASOS\_SumMsg** routine to parse the raw ASOS summary message into individual tokens and



move them into the text database. The **ASOS\_smDecoder** uses the **ASOS\_DSMDecoder** and **ASOS\_MSMDecoder** routines to decode the tokens accordingly and uses the **transfer\_2db** routine to transfer the decoded summary pages into the **hmdb** database where they can be used by the Climate program. Two lines of code must be contained in **\$FXA\_HOME/data/localization/nationalData/adaptTrigger.template** for the ASOS Daily Summary Message (DSM) and the ASOS Month Summary Message (MSM) to be decoded.

The first line of code triggers the decoding of the DSM. It is:

```
wwwDSMXXX | | | /awips/adapt/climate/bin/Linux/ASOS_smDecoder.sh
|
```

The second line triggers the decoding of the MSM. It is:

```
wwwMSMXXX | | | /awips/adapt/climate/bin/Linux/ASOS_smDecoder.sh
|
```

#### ► To View the Current Day's ASOS\_smDecoder Log

On PX1, as user fxa or your individual user account,

**TYPE:** `cd $LOG_DIR/<yyyymmdd>`  
 ▪ Where **<yyyymmdd>** is today's date.

**TYPE:** `ls -ltr ASOS_smDecoder*`  
 ▪ Displays the current day's **ASOS\_smDecoder** logs from earliest to latest.

**TYPE:** `tail -f <logname>`  
 ▪ Displays the latest registered messages as the log updates.

#### Log Message Format

An entry in the log should look like the following:

```
08:14:06.686 ASOS_smDecoder.C PROBLEM:
ASOS DSM Decoder could not parse the product SFODSMEKA
Check product in the database
```

The log consists of the following fields:

|                |                                                                                      |
|----------------|--------------------------------------------------------------------------------------|
| Time stamp     | 08:14:06.686                                                                         |
| File name      | ASOS_smDecoder.C                                                                     |
| Message type   | PROBLEM:                                                                             |
| Message string | ASOS DSM Decoder could not parse the product SFODSMEKA Check product in the database |

**create\_climate**

The **create\_climate** process stores observations for the stations selected by the forecaster in the **set\_up\_climate** process. The observations are derived from the Daily Summary Message (DSM) data contained in the **cli\_asos\_daily** table, METAR data contained in the **rpt** table in the **hmdb** database, and from the Supplementary Climate Data (SCD) stored in the **fss\_report** table. Parameters that are derived from observed variables, such as heating and cooling degree days, precipitation and snowfall to date for the month, season and year, are calculated by the **display\_climate** process after the forecaster has had the opportunity to review and edit the data as necessary.

- The **create\_climate** process obtains inputs as follows:
- The type of report to be formatted via the **control\_am/im/pm** and **global\_day** files (for daily report) and **control\_mon/sea/ann** and **global\_day** files for monthly/seasonal/annual reports
- The setup information from the **cli\_sta\_setup** table
- The daily climate normals from the **day\_climate\_norm**
- The monthly/seasonal/annual climate normals from the **mon\_climate\_norm**.

The **create\_climate** process composes one listing, (**data\_am/im/pm** file for daily and **data\_mon/sea/ann** file for monthly/seasonal/annual), containing each station's name and all of the element names for which the day's observations and climatological information will be inserted and another for yesterday's data (i.e., history file). The **create\_climate** process also creates a file **info\_am/im/pm** (for daily) and **info\_mon/sea/ann** (for monthly/seasonal/annual) with sunrise and sunset times for each station (i.e., **info\_file**).

► **To View the Current Day's create\_climate Log**

On PX1 as user fxa or your individual user account,

**TYPE:** `cd $LOG_DIR/<yyyymmdd>`

- Where **<yyyymmdd>** is today's date.

**TYPE:** `ls -ltr create_climate*`

- Displays the current day's **create\_climate** logs from earliest to latest.

**TYPE:** `tail -f <logname>`

- Displays the log as it updates with the latest messages.

## Log Message Format

An entry in the log should look like the following:

```
12:25:54.286 get_all_hourly_gusts.c EVENT: get_all_hourly_gusts
For station id 11300, the hourly wind gust weather element is missing for the
hour 2006-05-11 05. STATUS_FAILURE returned by the database.

12:25:54.572 get_hourly_peak_winds.c EVENT: get_hourly_peak_winds
For station id 11300, the peak wind weather element is missing for hour
2006-05-11 06. STATUS_FAILURE returned by the database.
12:25:54.973 get_hourly_peak_winds.c EVENT: get_hourly_peak_winds
For station id 11300, the peak wind direction weather element is missing for
hour 2006-05-11 06. STATUS_FAILURE returned by the database.

12:25:55.028 get_hourly_peak_winds.c EVENT: get_hourly_peak_winds
For station id 11300, the peak wind direction weather element is missing for
this particular hour. STATUS_FAILURE returned by the database.

12:25:55.175 get_all_hourly_gusts.c EVENT: get_all_hourly_gusts
For station id 11300, the hourly wind gust weather element is missing for the
hour 2006-05-11 06. STATUS_FAILURE returned by the database.
12:25:57.103 get_sky_cover.ec EVENT:
Bug in g: For station id 11300 at time 2006-05-10 19 the sky cover was not
reported the fss_cloud_layer table.
```

The log consists of the following fields:

|                |                                                                                                                                                                 |
|----------------|-----------------------------------------------------------------------------------------------------------------------------------------------------------------|
| Time stamp     | 12:25:54.973                                                                                                                                                    |
| File name      | get_hourly_peak_winds.c                                                                                                                                         |
| Message type   | EVENT:                                                                                                                                                          |
| Message string | get_hourly_peak_winds For station id 11300, the peak wind direction weather element is missing for hour 2006-05-11 06. STATUS_FAILURE returned by the database. |

**display\_climate** The **display\_climate** process obtains daily climate values from the **data\_am/im/pm** file, and monthly/seasonal/annual climate values from the **data\_mon/sea/ann** file. A GUI displays the daily climate values for forecaster review and editing. After the forecaster has verified the accuracy, values for heating and cooling degree days, mean relative humidity, and accumulated precipitation and snowfall are calculated. This program displays the climate data generated by the **create\_climate** process. The forecaster can edit the data as necessary. The **display\_climate** process will calculate all derived fields and store them in the **daily\_climate** table in the **hmdb** database (for daily) and **cli\_mon\_season\_yr** table for the monthly/seasonal/annual.

### ► To View the Current Day's **display\_climate** Log

On any workstation as user fxa or your individual user account,

- TYPE:** `cd $LOG_DIR/display/<display>/<yyyymmdd>`
- Where `<yyyymmdd>` is today's date and `<display>` is the current display variable (e.g., `lx2-tbdw:0`).
- TYPE:** `ls -ltr display_climate*`
- Displays the current day's `display_climate` logs from earliest to latest.
- TYPE:** `tail -f <logname>`
- Displays the log as it updates with the latest messages.

### Log Message Format

An entry in the log should look like the following:

```
LOG-STATUS: Log file opened on host lx2-rnk at Wed May 12 16:09:05 2004
display_climate 19870 949507745.583942 16:09:05.583 PROBLEM: const char
ERROR: ERROR, SQLSTATE = 2300
display_climate 19870 949507745.759790 16:09:05.759 PROBLEM: Unique
constraint (informix.u178_228) violated.
display_climate: 19870 949507745.583942 16:09:05.802 PROBLEM: const char
ERROR: ERROR, SQLSTATE = 2300
display_climate 19870 949507745.803177 16:09:05.803 PROBLEM: Unique
constraint (informix.u178_228) violated.
display_climate 19870 949507745.826989 16:09:05.826 PROBLEM: const char
ERROR: ERROR, SQLSTATE = 2300
display_climate 19870 949507745.827594 16:09:05.827 PROBLEM: Unique
constraint (informix.u178_228) violated.
```

The log consists of the following fields:

|                |                                           |
|----------------|-------------------------------------------|
| Time stamp     | 16:09:05.583                              |
| Module name    | display_climate                           |
| Message type   | PROBLEM:                                  |
| Message string | const char ERROR: ERROR, SQLSTATE = 23000 |

**format\_climate** The **format\_climate** process obtains the type of report to be formatted, station information, forecaster-reviewed daily observations and climatological data, and header information from the forecaster configuration. The **format\_climate** process converts numerical values to ASCII text, builds phrases, adds instructions for the CRS, and creates tabular products for the NWS. When a record has been established, information is piped to the **RecordClimateRawData.dat** and **RecordClimateStationInfo.dat** files, which are used by the **recordClimate** process.

The NWR output product is stored temporarily and the forecaster is notified of its completion. Occasionally, the NWR product may need to be edited before it is sent to the CRS. The forecaster can change the NWR product using the **NWRBrowser**. The forecaster can send the product directly to the CRS once it has

been edited and reviewed. If the forecaster does not send the product manually to the CRS via the **NWRBrowser**, it will be sent automatically after a user-specified or configuration-specified period of time. The default time is 20 minutes.

Before the NWWS product is distributed for broadcast over the WAN, it is displayed for the forecaster to view, edit, or delete in the **Review Climate GUI**. The **handleOUP.pl** script automatically sends the completed files for NWWS distribution. The NWWS product will always be automatically sent. Storing the NWWS product in the text database provides the forecaster with an opportunity to view the product without having to wait for it to arrive over the SBN.

**NOTE:** If the Climate program runs but you do not receive any alarms (“eyeglasses” icon and/or beeping) on the workstation, it may be that the **hmMonitorServer** process is down and needs to be restarted. The Climate program should notify you when the **hmMonitorServer** is down. Refer to Section 9.4.2 for more information on the **hmMonitorServer**, including how to restart it.

► **To View the Current Day’s format\_climate Log**

On PX1, as user fxa or your individual user account,

**TYPE:** `cd $LOG_DIR/<yyyymmdd>`  
 ▪ Where <yyyymmdd> is today’s date.

**TYPE:** `ls -ltr format_climate*`  
 ▪ Displays the current day’s **format\_climate** logs from earliest to latest.

**TYPE:** `tail -f <logname>`  
 ▪ Displays the log as it updates with the latest messages.

### Log Message Format

An entry in the log should look like the following:

```
12:45:15.015 c_format_climate.c EVENT: Running recordClimate from within
format_climate..
12:45:15.198 c_format_climate.c EVENT: Recordclimate returned with code 0
12:45:30.290 c_format_climate.c PROBLEM: /data/logs/fxa/
12:45:30.291 c_format_climate.c PROBLEM: debug log:
/data/logs/fxa/20060614/transferNWWS.log
12:45:30.290 c_format_climate.c PROBLEM: AFOSID = BOSCLIBOS
12:45:30.291 c_format_climate.c PROBLEM: logDIR:
/data/logs/fxa/20060614/handleOUP.log
```

### 9.1.4 GUIs

Each GUI is associated with a particular program. Table 9.1.4-1 lists each GUI with its corresponding executable.

**Table 9.1.4-1. Climate GUIs and Corresponding Executables**

| GUI                                      | Executable Program                                                       |
|------------------------------------------|--------------------------------------------------------------------------|
| Climate Master                           | set_up_climatedo_all_climateinit_climatebuild_f6qc_climatecreate_climate |
| Climate Preferences                      | set_up_climate                                                           |
| Edit Station List                        | set_up_climate                                                           |
| View/Edit Annual Periods                 | set_up_climate                                                           |
| View/Edit Reporting Periods              | set_up_climate                                                           |
| Report Format                            | set_up_climate                                                           |
| Edit User Defined Values                 | set_up_climate                                                           |
| Current Products                         | set_up_climate                                                           |
| Climatology Normals, Means, Extremes     | init_climate                                                             |
| Import Climate                           | init_climate                                                             |
| Choose File to Be Imported               | init_climate                                                             |
| Import Daily or Monthly Climatology Data | init_climate                                                             |
| Column Placement                         | init_climate                                                             |
| Daily Normals, Means, Extremes           | init_climate                                                             |
| Monthly Normals and Extremes             | init_climate                                                             |
| Seasonal Normals and Extremes            | init_climate                                                             |
| Annual Normals and Extremes              | init_climate                                                             |
| Edit Climatological Data                 | qc_climate                                                               |
| Select Climate Run Date                  | create_climate                                                           |
| Display Station Climate Values           | display_climate                                                          |
| Review Climate Product                   | format_climate                                                           |
| F6 Product Date                          | build_f6                                                                 |
| Climate is Running                       | display_climate                                                          |
| Climate Error                            | display_climate                                                          |

**Climate Master GUI** This GUI is used to execute the following programs and scripts:

```

set_up_climate (set_up_climate_runs and
                set_up_climate_stations)
do_all_climate
init_climate
build_f6
qc_climate
• create_climate

```

|                                        |                                                                                                                                                                                                                                                                                                                                                                                                                                                                                                                                                                                                                |
|----------------------------------------|----------------------------------------------------------------------------------------------------------------------------------------------------------------------------------------------------------------------------------------------------------------------------------------------------------------------------------------------------------------------------------------------------------------------------------------------------------------------------------------------------------------------------------------------------------------------------------------------------------------|
| <b>Climate Preferences GUI</b>         | This GUI, launched by pressing the <b>Configure Climate Parameters</b> pushbutton on the <b>Climate Master GUI</b> , is used to set the parameters that affect all products created by the climate application. These global variables include valid times for intermediate and evening reports, configuration of the station list, setting the season or alternate annual begin dates, setting the temperature, precipitation, and snowfall threshold values for monthly, seasonal, and annual stations. These global variables also establish some product format selections format for NWS output products. |
| <b>Edit Station List GUI</b>           | This GUI can be used to edit the Climate's station list. It is launched by pressing the <b>Set Up Climate Station</b> pushbutton on the <b>Climate Preference GUI</b> or by pressing the <b>Edit Station List</b> button on the <b>Report Format GUI</b> . The <b>Edit Station List GUI</b> has three functions: add/delete stations; edit station names; and identify stations that observe standard time year round.                                                                                                                                                                                         |
| <b>View/Edit Annual Periods GUI</b>    | This GUI is launched by the <b>Edit Alternate Annual Periods</b> pushbutton on the <b>Climate Preference GUI</b> or by pressing the <b>Edit Annual Periods</b> pushbutton on the <b>Report Format GUI</b> . This <b>View/Edit Annual Periods GUI</b> is used to define alternate annual or seasonal start dates for summing precipitation and snow observations.                                                                                                                                                                                                                                               |
| <b>View/Edit Reporting Periods GUI</b> | This GUI is launched by pressing the <b>Edit Reporting Periods</b> pushbutton on the <b>Report Format GUI</b> and is used to determine when heating degree days, cooling degree days, and snow appear in the climate output. These data are displayed in the report only during the period specified by the user even though these statistics are always being calculated by the Climate program.                                                                                                                                                                                                              |
| <b>Report Format GUI</b>               | This GUI, launched by pressing the <b>Set Up/Edit Climate Products</b> pushbutton on the <b>Climate Master GUI</b> , is Climate's hub for creating, editing and deleting products. The type of output (i.e., NWR or NWS, daily morning, intermediate, evening, monthly, seasonal, or annual), the stations to be included, configuration parameters (i.e., effective and expiration times for NWR output), and weather elements to be included in the product are all selected in this GUI.                                                                                                                    |

**Edit User-Defined Values GUI**

This GUI is launched by the **Edit User-Defined Thresholds** pushbutton on the **Climate Preference GUI** or by pressing the **Change Threshold Values** button on the **Report Format GUI**. This **Edit User-Defined Values GUI** is used to set the threshold values for maximum and minimum temperature, precipitation, and snowfall. The values that are entered will be displayed in the monthly, seasonal, or annual report.

**NOTE:** The Morning Climate product summarizes climate data from midnight to midnight local standard time (LST) of the previous day. It is determined from station data entered into the daily climate database. Evening climate summaries produce reports for the current day from midnight through either a valid time or the time that the climate program is executed (user's preference). Data from evening climate summaries are not written to the database. Intermediate climate summaries are similar to evening runs and provide a third time of day for reporting climate information. Report Format is initiated by selecting **Set Up/Edit Climate Products** from the **Climate Master GUI**.

**Current Products GUI**

This GUI is launched from the **Option** pull-down menu in the **Report Format GUI**. It provides a list of climate products that have been created.

**Climatology Normals, Means, Extremes GUI**

This GUI is displayed by the **init\_climate** program when **Initialize Climate Database** is selected from the **Climate Master GUI**. It is used to select the period during which the normals were calculated, records period, and the climatological input type (i.e., daily, monthly, seasonal, or annual) for one or more reporting stations. Forecasters may enter the climatological data in the **Daily Normals Means Extremes GUI**, **Monthly Normals And Extremes GUI**, **Seasonal Normals And Extremes GUI**, and the **Annual Normals And Extremes GUI**.

**Import Climate GUI**

This GUI is created by the **Climatology Normals, Means, Extremes GUI** run by the **init\_climate** program. It is activated by selecting the **File** menu on the **Climatology Normals, Means, Extremes GUI** and selecting **Import Data Window**. This GUI allows forecasters to import daily, monthly, seasonal, or annual data files into the database.

**NOTE:** Some formats cannot be imported. Under these circumstances the forecaster must manually enter the data.



|                                                     |                                                                                                                                                                                                                                                                                                                                                                                                                                                     |
|-----------------------------------------------------|-----------------------------------------------------------------------------------------------------------------------------------------------------------------------------------------------------------------------------------------------------------------------------------------------------------------------------------------------------------------------------------------------------------------------------------------------------|
| <b>Choose File To Be Imported GUI</b>               | This GUI is created by the <b>Import Climate GUI</b> by pressing the <b>Get New Data File Name</b> pushbutton. It allows the forecaster to browse the directories for the import file.                                                                                                                                                                                                                                                              |
| <b>Import Daily or Monthly Climatology Data GUI</b> | This GUI is displayed when the user selects <b>Arrange Order of Data</b> from the <b>Import Climate GUI</b> . It allows the forecaster to arrange specific variables according to the format of the Weather Forecast Office's (WFO) existing climatology file so it may be correctly entered into the climatology database.                                                                                                                         |
| <b>Column Placement GUI</b>                         | This GUI is created when the <b>Place</b> button is activated in the <b>Import Daily or Monthly Climatology Data GUI</b> . This GUI allows the forecaster to move the selected variable from <b>Climatology Data Options</b> to a specific column number under <b>Order of Data in File</b> .                                                                                                                                                       |
| <b>Daily Normals, Means, Extremes GUI</b>           | This GUI is displayed by the <b>init_climate</b> program simultaneously with the <b>Climatology Normals, Means, Extremes GUI</b> when <b>Initialize Climate Database</b> is selected from the <b>Climate Master GUI</b> . It allows the forecaster to enter and modify a station's daily climatological data. This capability will be most useful at the site startup time to establish the climatological information in the <b>hmdb</b> database. |
| <b>Monthly Normals And Extremes GUI</b>             | This GUI is created by the <b>init_climate</b> program. It becomes visible when the forecaster selects <b>Monthly</b> on the <b>Climatology Normals, Means, Extremes GUI</b> . This GUI is used to enter and modify monthly climatological data for a station. This capability will be most useful at the site start-up time to establish the climatological information in the <b>hmdb</b> database.                                               |
| <b>Seasonal Normals And Extremes GUI</b>            | This GUI is created by the <b>init_climate</b> program. It becomes visible when the forecaster selects <b>Seasonal</b> on the <b>Climatology Normals, Means, Extremes GUI</b> . This GUI is used to enter and modify seasonal climatological data for a station. This capability will be most useful at the site start-up time to establish the climatological information in the <b>hmdb</b> database.                                             |

|                                           |                                                                                                                                                                                                                                                                                                                                                                                                     |
|-------------------------------------------|-----------------------------------------------------------------------------------------------------------------------------------------------------------------------------------------------------------------------------------------------------------------------------------------------------------------------------------------------------------------------------------------------------|
| <b>Annual Normals And Extremes GUI</b>    | This GUI is created by the <b>init_climate</b> program. It becomes visible when the forecaster selects <b>Annual</b> on the <b>Climatology Normals, Means, Extremes GUI</b> . This GUI is used to enter and modify annual climatological data for a station. This capability will be most useful at the site start-up time to establish the climatological information in the <b>hmdb</b> database. |
| <b>Edit Climatological Data GUI</b>       | The <b>qc_climate</b> program displays this GUI once the forecaster selects <b>Quality Control Climate Database</b> from the <b>Climate Master GUI</b> . The forecaster can review and edit the daily, monthly, seasonal, or annual weather parameters in the GUI.                                                                                                                                  |
| <b>Select Climate Run Date GUI</b>        | This GUI is displayed once the forecaster executes a Climate run. The forecaster can default to the most recent time period for the climate product or choose a specific date for any given day, month, season, or year. When the forecaster executes an Intermediate or Evening Daily Climate Report, the only available option is to run the latest intermediate or latest evening climate.       |
| <b>Display Station Climate Values GUI</b> | This GUI is used to review, edit, and accept the observation values prior to formatting. Modifications to a station's data must be saved before going on to the next station; if not, the changes will be lost. This GUI is a part of the <b>display_climate</b> program.                                                                                                                           |
| <b>F6 Product Date and Stations GUI</b>   | When the user selects <b>Create F6 Products</b> on the <b>Climate Master GUI</b> , this GUI is used to request an F6 product for any station in the station list for the current month up to the day prior to execution or for a chosen prior month. There is an additional selection for a printout of the output.                                                                                 |
| <b>Climate Is Running GUI</b>             | This GUI is used to notify the user that Climate processes are running. When Climate is running and the GUIs disappear, this button shows the user that Climate is running and has not terminated.                                                                                                                                                                                                  |
| <b>Climate Error GUI</b>                  | This GUI is used to notify the user that the Climate application encountered an error and has terminated. It allows the user to either view the log file or close the GUI.                                                                                                                                                                                                                          |

### 9.1.5 *Climatological Reports Formatter Setup*

There are three main steps to configure the Climate program:

1. **Configure the global climate parameters.** Set product valid times, create the station list, set season dates, set the threshold values, and format the NWWS output.
2. **Establish a historical database for each station.** Enter data manually or import data files through the import data option.
3. **Configure climate products.** A product is a single output from the climate program, i.e., a means of dissemination (NWR or NWWS). The stations selected as well as the chosen variables and elements are included in the output.

To run Climate, the forecaster left clicks on the workspace window (menu), selects **AWIPS** and selects **Climate Reports** from the **Background WFO Apps** submenu in the **Workspace** menu. This will bring up the main **Climate Master GUI**.

### 9.1.5.1 *Configure Global Climate Parameters*

The Climate Formatter relies on several parameters that affect all output the application generates. These consist of the valid times for the intermediate and evening summaries, the stations in the product station list, the starting dates for seasonal climate summaries, the threshold values for temperature, precipitation and snowfall, and format options for the NWWS products. Selecting **Configure Climate Parameters** from the **Climate Master GUI** displays the **Climate Preferences GUI** used to set the parameters.

#### **Valid Time**

The forecaster has two options for setting the valid time of the intermediate and evening climate summaries: a specific time, or execution time of the Climate Formatter. To set the valid time to a specific time, select that option and type in a two-digit hour in local time. Select **AM** or **PM** from the option box next to the hour.

#### **Station List**

To set up the station list for the stations of interest, the forecaster must first select **Set Up Climate Stations** from the **Climate Preferences GUI**. The **Edit Station List GUI** is displayed and the forecaster can add stations to or delete stations from the station list using the following options:

**Adding a Station:** In the blank **Station ID** field, the forecaster types the four-character International Civil Aviation Organization (ICAO) identifier of the stations for which the WFO has responsibility. The ICAO identifiers must be typed in uppercase letters. The name of the station appears in the corresponding **Name** field. To edit the names, simply select the desired **Name** field and edit the text.

**NOTE:** You must use uppercase letters for station identifiers or there will not be a match between your choice and the data in the master stations table.

**Deleting a Station:** Simply remove the four-letter ID from the appropriate **Station ID** field, and the associated station name is automatically erased.

**NOTE:** The information about stations is included in the **cli\_sta\_setup** table (**hmdb** database).

### **Standard Time**

Selecting the **Std Time All Year** box beside the station name indicates that the station does not switch to Daylight Savings Time for part of the year. This is important so the Climate Formatter can correctly adjust between local time and UTC.

**NOTE:** Choosing the **Save Stations** button saves any changes made to the list.

### **Annual Periods**

Another global parameter is the alternate annual periods defining the start of the seasonal sums for precipitation and snow. Selecting the **Edit Alternate Annual Periods** button displays the **View/Edit Annual Periods GUI**. The seasonal sums can be set to either **Current 3 Month Season** or an entire year beginning with a forecaster-defined date.

### **Threshold Values**

The threshold values for temperature, precipitation, and snowfall can be set by selecting the **Edit User-Defined Thresholds** button. The **Edit User-Defined Values GUI** pops up and the threshold values are entered into the fields in which they apply. After the threshold values are entered, choose **Save** to save the changes and close the GUI.

### **Formatting Options**

Several options are available to the forecaster for formatting the NWS products produced by the Climate Formatter. For example, depending on the options the forecaster selects: Output text can be all uppercase or it can contain lowercase letters; negative values can be indicated with either a dash (-) or an upper case "M"; colons may or may not be used to separate phrases such as "Climate Normal Period" and "Climate Record Period" from the dates comprising the periods; and record values can be identified with an asterisk "\*" or an "R."

**NOTE:** Selecting the **Save** button saves any changes made via **Climate Preferences GUI**.

### 9.1.5.2 *Establishing the Historical Database*

Establishing the Historical Database is initiated when The Forecaster Selects **Initialize Climate Database** From The **Climate Master GUI**. The **CLIMATOLOGY NORMALS, MEANS, EXTREMES GUI** and the **Daily Normals, Means, Extremes GUI** are displayed. At this point, the forecaster has the option of entering the historical, daily, monthly, seasonal, and annual data manually or importing the data.

#### 9.1.5.2.1 *Entering Historical Data Manually*

The forecaster may enter the historical data manually using the **Climatology Normals, Means, Extremes GUI** and one of the four resulting GUIs:

- **Daily Normals, Means, and Extremes**
- **Monthly Normals and Extremes**
- **Seasonal Normals and Extremes**
- **Annual Normals and Extremes.**

First, the forecaster must select the station name. The **Station** field provides the forecaster with the option to select the climatological station name for which data are to be immediately displayed in any of the above GUIs depending on what **Climatology Input Type** is selected. The station name must be double clicked for the second GUI to respond. The forecaster enters the **Start** and **Ending** year for the **Normals and Records Periods** in the **Climatology Normals, Means, Extremes GUI**.

#### **Climatological Input Type**

This field provides the option to select the climatological reports input data type template that will be displayed in the second GUI. The choices listed are as follows:

- Daily
- Monthly
- Seasonally
- Annual

**Daily Climatology Files** If the historical data are of daily climatology, the **Daily** button should be selected. Next, in the **Daily Normals, Means, Extremes GUI** select the **Month** and **Day** corresponding to the file and enter the appropriate values in each field. The observation month and day can be entered in these two fields by two methods. The forecaster can either make a selection from the pull- down menus or increment these fields using the up and down arrows. After the new values for that day are entered, select **Modify Record** to go on to another day or **Add Record** if this is an original entry.

**Station.** This field displays the station name selected by the forecaster.

**Month and Day.** The observation month and day can be entered in these two fields by two methods. The forecaster can either make a selection from the pull-down menus or increment these fields using the up and down arrows.

**First.** This option displays the first record in the database that contains data for the selected station.

**Add Record.** This button saves the changes to the database only if the record has been modified for the first time.

**Modify Record.** This button saves the changes to the database only if changes have been made to a record that previously contained data.

**Delete Record.** The displayed day's data are deleted from the **hmdb** database when this field is selected. The forecaster is prompted to confirm the deletion.

**Last.** This option displays the last record in the database that contains data for the selected station. The purpose of this button is to permit the forecaster to find the last data entry point when resuming a manual data entry session.

**Temperature.** Various climatological temperature data can be entered in the 11 GUI temperature fields:

- The **Mean Maximum Temperature** is a field for the day's normal high temperature.
- The **Record Maximum Temperature** is a field for the highest temperature for the calendar day over the Records Period.
- The most recent year in which the record for the day

occurred can be entered in the **Year 1 Record Maximum Temperature Observed** field.

- When the record temperature for the day has occurred in additional years, the second most recent year and the third most recent year can be entered in the **Year 2 Record Maximum Temperature Observed** and the **Year 3 Record Maximum Temperature Observed** fields, respectively.
- The **Mean Minimum Temperature** is a field for the day's normal minimum temperature.
- The **Record Minimum Temperature** is a field for the lowest temperature for the calendar day, over the Records Period.
- The most recent year in which the record for the day occurred can be entered in the **Year 1 Record Minimum Temperature Observed** field.
- When the record temperature for the day has occurred in additional years, the second most recent year and the third most recent year can be entered in the **Year 2 Record Minimum Temperature Observed** and the **Year 3 Record Minimum Temperature Observed** fields, respectively.
- The **Normal Mean Temperature** is a field for the day's normal mean temperature.

**NOTES:**

1. If the **Year 1 Record Maximum Temperature Observed** is missing DO NOT enter any years for **Year 2** or **Year 3**.
2. If the **Year 1 Record Minimum Temperature Observed** is missing DO NOT enter any years for **Year 2** or **Year 3**.

**Heating/Cooling Degree Days.** These fields are for the normal heating degree days and cooling degree days for the day. Missing values are indicated by **-9999**, since it is possible to have values up to 25000.

**Precipitation.** Various climatological precipitation data can be entered in the five GUI precipitation fields.

- The **Average Precipitation** is a field for that day's normal precipitation amount.
- The **Record Maximum Precipitation** is a field for the

greatest precipitation for that calendar day over the Records Period. For all of these fields, trace amounts are represented as T.

- The most recent year in which a record occurred can be entered into the **Year 1 Record Maximum Precipitation Observed** field.
- When the record maximum precipitation for the day has occurred in additional years, the second most recent year and the third most recent year can be entered in the **Year 2 Record Maximum Precipitation Observed** and the **Year 3 Record Maximum Precipitation Observed** fields, respectively.

**NOTE:** If the **Year 1 Record Maximum Precipitation Observed** is missing, do not enter any years for **Year 2** or **Year 3**.

**Snowfall.** The first five fields are analogous to the Precipitation fields. The sixth field, **Daily Snow on Ground (inches)**, is the snow depth for that day. For all of these fields, trace amounts are represented as T.

After the new values for that day are entered, select **Modify Record** to go on to another day or **Add Record** if this an original entry.

### Monthly Climatology Files

If the historical data are of monthly climatology, the **Monthly** button should be selected. Next, in the **MONTHLY NORMALS AND EXTREMES GUI** select the Month corresponding to the file and enter the appropriate values in each field.

**Station.** This field displays the station name that was selected by the forecaster using the **CLIMATOLOGY NORMALS, MEANS, EXTREMES GUI**.

**Month.** The observation month can be entered in this field by two methods. The forecaster can either make a selection from the pull-down menus or increment the field using the up and down arrows.

**First.** This GUI option displays the data for the first day entered.

**Add Record.** This field adds data to the **hmdb** database for a day which never had any data entered before.



**Modify Record.** This GUI option provides the capability to modify the data currently displayed for any field in the GUI and sequentially saves the data to the **hmdb** database.

**Delete Record.** The displayed day's data are deleted from the **hmdb** database when this field is selected. The forecaster is prompted to confirm the deletion.

**Last.** When this GUI option is selected, the last day's data entered are displayed. The purpose of this button is to permit the forecaster to find the last entry point when resuming a manual data entry session.

**Temperature.** The temperature fields are divided into a **Normals** and a **Records** section.

- The normal maximum monthly temperature can be entered into the first field, the **Maximum Temperature (°F)** field. This value represents the average of the highest monthly temperature in each year of the Normals Period.
- The normal average maximum monthly temperature can be entered into the **Average Maximum Temperature (°F)** field.
- The normal number of days per month when daily maximum temperatures are greater than or equal to 90 degrees Fahrenheit can be entered into the **Days with Maximum Temperature GE 90°F** field.
- The normal number of days per month when daily maximum temperatures are less than or equal to 32 degrees Fahrenheit can be entered into the **Days with Maximum Temperature LE 32°F** field.
- The normal minimum monthly temperature can be entered into the **Minimum Temperature (°F)** field. This value represents the average of the lowest monthly temperature in each year of the Normals period.
- The normal average minimum monthly temperature can be entered into the **Average Minimum Temperature (°F)** field.
- The normal number of days per month when daily minimum temperatures are less than or equal to 32 degrees Fahrenheit can be entered into the **Days with Minimum Temperature LE 32°F** field.
- The normal number of days per month when daily minimum temperatures are less than or equal to 0 degrees

Fahrenheit can be entered into the **Days with Minimum Temperature LE 0°F** field.

- The normal monthly mean temperature can be entered into the **Mean Temperature (°F)** field.

Additional climatological temperature data are calculated by the Climate program from the daily database. The following GUI Records section temperature fields can be viewed but not edited:

- The first temperature field in the Records section is the **Maximum Temperature (°F)** field which is for the record highest temperature in that month.
- The **Date 1 Maximum Temperature Observed** field is for the most recent day and year in which the record maximum temperature was observed.
- If the record was tied in additional years, the second most recent day and year can be entered into the **Date 2 Maximum Temperature Observed** field, and the third most recent day and year can be entered into the **Date 3 Maximum Temperature Observed** field.
- The next temperature field in the Records section is the **Minimum Temperature (°F)** field in which the record minimum temperature in that month can be entered.
- The most recent year in which the record minimum temperature was observed can be entered into the **Date 1 Minimum Temperature Observed** field.
- If the record was tied in additional years, the second most recent year can be entered into the **Date 2 Minimum Temperature Observed** field, and the third most recent year can be entered into the **Date 3 Minimum Temperature Observed** field.

**Precipitation.** The Precipitation fields are divided into a **Normals** section and a **Records** section.

In the **Normals** section:

The first field is the **Total Precipitation (inches)** field in which the normal total monthly precipitation can be entered.

The normal average amount of precipitation for a day in that month can be entered into the **Daily Average Precipitation (inches)** field.

The normal number of days in the month with

precipitation greater than or equal to 0.01 inches can be entered into the **Days with Precipitation GE 0.01 Inches** field.

The normal number of days in the month with precipitation greater than or equal to 0.10 inches can be entered into the **Days with Precipitation GE 0.10 Inches** field.

The normal number of days in the month with precipitation greater than or equal to 0.50 inches can be entered into the **Days with Precipitation GE 0.50 Inches** field.

The normal number of days in the month with precipitation greater than or equal to 1.00 inch can be entered into the **Days with Precipitation GE 1.00 Inch** field.

In the **Records** section:

The first precipitation field is the **Maximum Total Precipitation (inches)** field in which the record maximum monthly precipitation amount can be entered.

The most recent year in which the record maximum monthly precipitation was observed can be entered into the **Date 1 Maximum Precipitation Observed** field.

When the record has occurred in additional years, the second most recent year can be entered into the **Date 2 Maximum Precipitation Observed** field, and the third most recent can be entered into the **Date 3 Maximum Precipitation Observed** field.

The next precipitation field is the **Minimum Total Precipitation (inches)** field in which the record minimum monthly precipitation amount can be entered.

The most recent year in which the record minimum monthly precipitation was observed can be entered into the **Date 1 Minimum Precipitation Observed** field.

When the record has occurred in additional years, the second most recent year can be entered into the **Date 2 Minimum Precipitation Observed** field, and the third most recent can be entered in **Date 3 Minimum Precipitation Observed** field.

**Snow.** The snow fields are also divided into a **Normals** section and a **Records** section.

In the **Normals** section:

The first field is the **Total Snowfall (inches)** field in which the normal total monthly snowfall can be entered.

The water equivalent of the normal total monthly snow that falls can be entered into the **Total Water Equivalent (inches)** field.

The normal amount of snow on the ground for any day in the month can be entered into the **Snow Depth (inches)** field.

The normal number of days on which snow occurs in the month can be entered into the **Days with Any Snowfall** field.

The normal number of days on which snowfall is equal to or greater than 1 inch can be entered into the **Days with Snowfall GE 1.0 inch.**

In the **Records** section:

The first field is the **Total Snowfall (inches)** field in which the record maximum total amount of snow that has ever fallen during that month can be entered.

The most recent year in which this record occurred can be entered into the **Date 1 Total Snowfall Observed** field.

When this record has occurred in additional years, the second most recent year and third most recent year can be entered into the **Date 2 Total Snowfall Observed** and the **Date 3 Total Snowfall Observed** fields, respectively.

The record maximum 24-hour snowfall can be entered into the **Total 24-Hour Snowfall (inches)** field.

The beginning day and month of the 24-hour record snowfall event can be entered into the **Date 1: Begin Date** field and the ending day, month, and year of the event can be entered into the **End Date** and **Year** fields.

When the record total 24-hour snowfall has occurred in additional years, the second most recent year's and the third most recent year's event dates can be entered into the **Date 2:** and the **Date 3:** fields, respectively.

The record snow depth at any time during the month can be entered into the **Snow Depth (inches)** field.

The date of the most recent event can be entered into the

**Date 1 Snow Depth Observed** field.

When the record snow depth has occurred in additional years, the second most recent year's and the third most recent year's event dates can be entered into the **Date 2 Snow Depth Observed** and the **Date 3 Snow Depth Observed** fields, respectively.

After the new values for the selected month are entered, select **Modify Record** and go on to another month, or **Add Record** if this is an original entry.

**Degree Days.** The degree days fields are divided into the Degree Days Normals, Freeze Dates Normals, and Records sections. The first field in the Degree Days Normals section is **Heating Degree Days** in which the normal number heating degree days for the month can be entered. The last field in this section is the **Cooling Degree Days** in which the normal number of cooling degree days for the month can be entered.

The first field in the Freeze Dates Normals section is the **Early Freeze Date**. The normal date of the earliest freeze can be entered in this field. The last field in this section is the **Late Freeze Date**. The normal date of the latest freeze can be entered into this field.

The first field in the Records section is the **Early Freeze Date**. The date of the record earliest freeze can be entered into this field. The last field is the **Late Freeze Date**. The date of the record latest freeze can be entered into this field.

**Seasonal Climatology Files**

If the historical data are for seasonal climatology, the **Seasonal** button should be selected in the **Climatology Normals, Means, Extremes GUI**. Next, in the **Seasonal Normals And Extremes GUI** use the **Month** button to select the 3-month season (DJF = December, January, February) corresponding to the file and enter the appropriate values in each field. After the new values for the selected month are entered, select **Modify Record** and go on to another season, or **Add Record** if this is an original entry. Fields are similar to the monthly ones.

### **Annual Climatology Files**

If the historical data are of annual climatology, the **Annual** button should be selected in the **Climatology Normals, Means, Extremes GUI**. Next, select the **Start Year** and **Ending Year** corresponding to the file and enter the appropriate values in each field in the **Annual Normals And Extremes GUI**. After the new values for the selected month are entered, select **Modify Record**, or **Add Record** if this is an original entry. Fields are similar to the monthly ones.

When all the data are entered, select **Close** in the **Climatology Normals, Means, Extremes GUI**.

**NOTE:** For all of the Climatology Files, the changes will be lost if **Modify Record** or **Add Record** is not selected before going on to another day, month, season, or year.

#### **9.1.5.2.2 Importing the Data**

The forecaster may import the historical data by selecting **Import Data Window** within the **File** menu in the **Climatology Normals, Means, Extremes GUI**. The **Import Climate GUI** launches and the forecaster may begin the process of importing files.

|                                     |                                                                                                                                                                                                                                                                                                                                                                                   |
|-------------------------------------|-----------------------------------------------------------------------------------------------------------------------------------------------------------------------------------------------------------------------------------------------------------------------------------------------------------------------------------------------------------------------------------|
| <b>Station Name</b>                 | This field displays the stations currently in the climate database.                                                                                                                                                                                                                                                                                                               |
| <b>Station Name(s) in Header(s)</b> | This button allows the forecaster to specify that the station name(s) appears in the header(s) of the import file. This is useful when the file contains more than one station's data separated by headers.                                                                                                                                                                       |
| <b>Station Name(s) in Data</b>      | This button allows the forecaster to specify that the station name(s) appears in the data of the import file.                                                                                                                                                                                                                                                                     |
| <b>Enter Data Delimiters</b>        | This field allows the forecaster to insert any delimiter that appears in the imported climatology file. The delimiter defaults are "*", "space," and "/." If any other delimiter is used, the forecaster must enter the appropriate character(s) into the field. There is no specific format for this; if entering more than one delimiter, neither spaces nor commas are needed. |

|                                    |                                                                                                                                                                                                                                                                                                                                                                                                                                                                                                                                                                                                                           |
|------------------------------------|---------------------------------------------------------------------------------------------------------------------------------------------------------------------------------------------------------------------------------------------------------------------------------------------------------------------------------------------------------------------------------------------------------------------------------------------------------------------------------------------------------------------------------------------------------------------------------------------------------------------------|
| <b>File Name</b>                   | This field displays the name of the import file. The file name will only appear after the forecaster goes through the process of <b>Getting a New Data File Name</b> . This button launches the <b>Choose File To Be Imported GUI</b> which allows the forecaster to browse the directories for the import file.                                                                                                                                                                                                                                                                                                          |
| <b>Data Type</b>                   | The <b>Daily</b> button and the <b>Monthly</b> button specify whether the import file is daily climatology or monthly climatology.                                                                                                                                                                                                                                                                                                                                                                                                                                                                                        |
| <b>Date Format</b>                 | This field lists the months of January through December and allows the forecaster to select what month(s) to which the file(s) pertains.                                                                                                                                                                                                                                                                                                                                                                                                                                                                                  |
| <b>Month Name(s) in Header(s)</b>  | This button allows the forecaster to specify if the month name(s) appears in the header(s). This is useful when a file contains more than one month's data separated by headers. The program searches for a match using the first three letters of the month. Consequently, abbreviations will be accepted.                                                                                                                                                                                                                                                                                                               |
| <b>Month Located in Date Field</b> | This button allows the forecaster to specify whether the month name is located in the data field. If so, the forecaster must select <b>Month First</b> if the format for the date places the month first, <b>Day First</b> if the format for the date places the day first, <b>Julian Days</b> if the date is recorded in Julian days, or <b>Julian Days (Feb29=60)</b> if the date is recorded in Julian days and the 29th of February is denoted as the 60th day. If you use <b>Julian Days</b> , the date field for the first 9 days of the year must be in the 01–09 format for the data to be successfully imported. |
| <b>Arrange Order of Data</b>       | This button allows the forecaster to specify the format of each data file. Once activated, this button will bring up the <b>Import Daily or Monthly Climatology Data GUI</b> where the forecaster arranges the climatology data according to the order of the data in the import file. <b>NOTE:</b> The format must be arranged before the file can be imported.                                                                                                                                                                                                                                                          |
| <b>Add File to List</b>            | This button adds the specified file to the pending list on the right. The specific file name, station, data type, data format and delimiter values become visible.                                                                                                                                                                                                                                                                                                                                                                                                                                                        |
| <b>Save New Values for File</b>    | This button saves any format changes made to the highlighted file located in the pending list.                                                                                                                                                                                                                                                                                                                                                                                                                                                                                                                            |
| <b>Delete from List</b>            | This button deletes the highlighted file from the import list.                                                                                                                                                                                                                                                                                                                                                                                                                                                                                                                                                            |

**Import Data from File(s)**

This button imports the data from all of the files contained in the import list.

**NOTE:** To view the imported data the forecaster must double-click on the **Station ID** in the **CLIMATOLOGY NORMALS, MEANS, EXTREMES GUI**. The data will appear in the appropriate fields within the **DAILY/MONTHLY NORMALS, MEANS, EXTREMES GUIs**.

**Cancel**

The **Cancel** button closes the **Import Climate GUI** without saving any changes. The same effect is achieved by toggling off the **Import Climate Window** option in the **File** menu of the **CLIMATOLOGY NORMALS, MEANS, EXTREMES GUI**.

The file formats supported by the **Import** function are described in Appendix M. Appendix M also describes the import procedure in more detail.

**NOTE:** It is helpful to have the file you are importing open in a separate window when you do this.

**Retrieving Files**

To get the file, the forecaster must select **Get New Data File Name**, which brings up the **Choose File To Be Imported GUI** and allows the forecaster to browse for the import file. Once a file name is found and selected, the **OK** button should be clicked and the file name will appear in the field below **File Name**.

**File Type** The forecaster must either select the **Daily** button if the data file is of daily climatology or the **Monthly** button if the data file is of monthly climatology. The forecaster must select the station(s) that is (are) included in the file and select **Station Name(s) in Header(s)**. If the Station Name(s) appear in the data, the corresponding button should be selected. The Station Names do not need to be manually selected for this option. If the import file contains delimiters other than the indicated defaults, they need to be entered in the field provided; otherwise, the field may be left blank. The next step is to select the month(s) included in the file and select **Month Name(s) in Header(s)**. If the Month is located in the data field the forecaster should select **Month(s) located in data field** specify how the month appears in the file.

**NOTE:** If the month(s) are located in the data field, the months do not need to be manually selected for this option.



## Configuring the File

Next, the forecaster should select **Arrange Order of Data** which brings up the **Import Daily or Monthly Climatology Data GUI** described as follows:

- Climatology Data Options** Includes a list of variables that may be contained in the WFO's daily or monthly climatology, dependent upon the format chosen for the file (**daily** or **monthly**). The file must contain a column with the Date, although the date may be "month/day," "day/month," or Julian date.
- Order of Data in File** Once a data element is selected in the **Climatology Data Options** list, it is displayed with its associated column number in this field. An element may be selected by double-clicking the left mouse button or by highlighting the element and single-clicking the **Append** button.
- Append** Moves selected element from **Climatology Data Options** to **Order of Data in File**. Append can also be activated by double-clicking the left mouse button.
- Place** Opens the **Column Placement GUI** and allows the forecaster to move the selected element from **Climatology Data Options** to a specific column number in the **Order of Data in File** field. This is helpful if the forecaster leaves an element out in the initial configuration, because that element can be added without starting over. The element placed will not remove any other elements, but will push the remaining list down one column.
- Append All** Moves all of the remaining elements in **Climatology Data Options** to the **Order of Data in File** field. The elements will keep the order in which they appear under **Climatology Data Options**. "Other data not listed" will not move unless directly selected and appended.
- Remove** Takes the selected element in the **Order of Data in File** and places it back in the **Climatology Data Options** field shifting the list up one place. If no element is selected, the element listed in column 1 is the default and will be removed. **Remove** can also be activated by double-clicking the left mouse button.
- Remove All** Selects all of the elements in the **Order of Data in File** field and places them in the **Climatology Data Options** field.
- Accept** Saves the changes and returns the forecaster to the **Import Climate GUI**.

**Cancel** Closes the GUI without saving the values and returns forecaster to the **Import Climate GUI**.

### Listing the File Name

To list the file that was configured, select **Add File to List** and the file name will appear in the pending list to the right. If additional files need to be imported, the forecaster may do so at this time by repeating the procedures above.

Once all the files in the pending list are ready to be imported, the forecaster needs to select **Import Data from File(s)**. The **Import Climate GUI** will close and return the forecaster to the **CLIMATOLOGY NORMALS, MEANS, EXTREMES GUI** and the **DAILY NORMALS, MEANS, EXTREMES GUI**. Selecting **Close** will return the user to the **Climate Master GUI**.

#### Notes:

1. After you have imported the data, double-click on the station name in the **CLIMATOLOGY NORMALS, MEANS, EXTREMES GUI**. This fetches the data you have just imported from the database and allows you to review the results.
2. When new records are set, they are automatically updated in the database.

### 9.1.5.3 Configuring Products

To configure Climate products, choose **Set Up/Edit Climate Products** from the **Climate Master GUI**. (**NOTE:** If **Set Up/Edit Climate Products** does not execute on the text workstation, try using the graphics workstation.) The **Report Format GUI** is displayed. It is divided into four sections for product manipulation:

- Report Type
  - Report Configuration
  - Select Stations for Product
  - Weather Elements
- ▶ **To Create a New Product**
    - Select:** **File** from the top-line menu
    - Select:** **New Product** from the pull-down menu
      - Initializes the fields on the **Report Format GUI** to default values.
  - ▶ **To View Existing Products**
    - Select:** **File** from the top-line menu

**Select: Open Existing Product**

- Submenus allow selection of any existing products by time period (Daily [morning, intermediate, evening]; Monthly, Seasonal, Annual).

The other top-line menu items either provide the means to display additional information or choices other than the buttons.

The top-line menu option **Edit** provides another means of editing the **Reporting Periods**, **Annual Periods**, **Threshold Values**, and **Station** list.

Also in this menu are **Select All Elements** and **Deselect All Elements** which select and deselect all of the weather elements, respectively.

Under **Options**, choosing **Current Products Window** causes a small window to appear which lists the products that have already been created and what type of report they produce. Double clicking the product ID will display that product's information in the **Report Format GUI**.

Selecting the buttons performs many of the same functions as the menu options.

Saving a product, deleting a product, and closing **Report Format** can all be done via the buttons.

Also, buttons are provided for editing the annual periods, the station list (refer to Section 9.1.5.1), and the reporting periods.

When the **Edit Reporting Periods** button is selected, the **View/Edit Reporting Periods GUI** is displayed. Reporting periods control when the heating and cooling degree days and snow sections appear in the Climate output.

When the **Edit Annual Periods** button is pressed, the **View/Edit Alternate Annual Periods** is displayed. The forecaster can use defaults or change the annual reporting period for snow and liquid precipitation.

### **Reporting Periods**

These three fields are for the entry of the snow, heating degree days (HDD), and cooling degree days (CDD) reporting periods. The month can be selected by clicking on the **Month** field and choosing from the pull-down menu. The forecaster can either directly type the **Day** or can increment/decrement using the up and down arrows to select the day.

Reporting Periods define the time period in which snow, heating degree days, and cooling degree days are reported.

### Alternate Annual Period (Season)

These two fields are for the entry of the beginning month and day of the seasonal periods. The month can be selected by clicking on the Month field and choosing from the pull-down menu. The forecaster can either directly type the Day or can increment/decrement the day using the up and down arrows. This will create an alternate annual period. Choosing the “Current 3 Month Season” results in a 3-month summary for the season to date total.

### Definition of Annual Periods

**Fixed.** These parameters cannot be changed and will always be the dates for the ‘year to date’ (YTD).

|      |                         |
|------|-------------------------|
| HDD  | 1 July - 30 June        |
| CDD  | 1 January - 31 December |
| Snow | 1 July - 30 June        |

**Default.** These parameters can be changed and will be seen in the **Alternate Annual Period** box.

|        |                         |
|--------|-------------------------|
| Precip | 1 January - 31 December |
| Snow   | 1 July - 30 June        |

The forecaster can create alternate annual periods for snow and precipitation using the **Alternate Annual Periods** box. These changes will appear in the NWWS products and are controlled by the **Season to Date** (STD) flag. The output header line will contain the words “Since 1 Aug” where 1 August is the start of the alternate year defined by the user.

If the forecaster creates an alternate annual period, it will be used in place of the normal seasonal values. That is to say, the “STD” flags will control the output of the alternate annual period. The “starting” date of the alternate annual period will be included in the NWWS output to make it clearer to the users.

If the forecaster does not change the default annual periods, the seasonal output for these variables will be for seasons defined in Table 9.1.5.3-1.

**Table 9.1.5.3-1. Default Annual Periods**

| Season | Months        |
|--------|---------------|
| Winter | Dec, Jan, Feb |
| Spring | Mar, Apr, May |
| Summer | Jun, Jul, Aug |
| Fall   | Sep, Oct, Nov |

**NOTE:** The forecaster cannot change this field; it is for information purposes only.

### 9.1.5.3.1 *Report Type, Report Configuration, Select Stations for Product*

**NOTE:** Morning reports produce climatology for the previous day. Intermediate and evening reports produce climatology for the current day.

► **To Configure NWR**

In the **Report Type** area, select the **NWR** button.

In the **Report Configuration**, enter a three-character **Product ID**, usually the station's three-character METAR ID.

**NOTE:** The product ID must be unique amongst morning or evening products. The same product ID can be used for a morning and an evening product. For example, DCA can be chosen for an NWR morning product and an NWR evening product; however, DCA cannot be chosen for both NWR morning and NWWS morning products.

Enter the following information:

**Periodicity:** The number of minutes in between broadcasts of the Daily Climatological Report

**Effective Time:** The earliest allowable broadcast time of the Daily Climatological Report

**Expiration Time:** The latest allowable broadcast time of the Daily Climatological Report

**Listening Area Code (LAC):** Notice that the LAC should be terminated by a "c." The program will inform you if you miss it.

**NOTE:** For the time fields, the forecaster can either directly type in the time or can increment/decrement using the up and down arrows to reach the desired value.

In the Report Type area, select the NWWS button. Select a corresponding button for Daily Morning, Daily Intermediate, Daily Evening, Monthly, Seasonal, or Annual.

In the Report Configuration, enter a three-character Product ID. The product ID can be any three characters. However, for this product ID to be transmitted, it must be a valid ID and recognized by the WAN.

**NOTE:** The product ID must be unique amongst morning or evening products. The same product ID can be used for a morning and an evening product. For example, DCA can be chosen for an NWR morning product and an NWR evening product; however, DCA cannot be chosen for both NWR morning and NWWS morning products.

The **Address** field is for the dissemination of the product. It may be stored locally (000), sent to another addressee, or sent to all addressees (**ALL**).

Once the **Report Type** and **Report Configuration** have been determined, move to the **Select Stations for Product** area. Use the mouse and click on the station codes to select stations for the climate product.

### 9.1.5.3.2 *Weather Elements*

The remainder of the **Report Format GUI** allows the forecaster to configure the climatology summary by toggling the weather element buttons on and off.

This section is further subdivided into two parts, the **Categories** list and the **Subcategories** field. The **Categories** list contains 10 general categories of elements available for the output product. Upon selecting an element from the list, available options for the variable appear in the **Subcategories** portion of the interface. For example, temperature is further divided into the maximum, minimum, and mean values. Also under **Categories**, toggle buttons are provided as shortcuts to either **Include All** or **None** of the subcategories within a given element. If **Include All** is chosen for temperature, for example, all temperature data will be included in the output product. Conversely, **Include None** results in no temperature data.

In the **Subcategories** section, the first item in the option lists is always the measured value for yesterday or today depending on the type of report chosen. The measured value has to be chosen before any other options such as the time of occurrence, record, record date, normal, departure, and previous year's value can be chosen. If the measured value is not chosen, the list of options beneath it will disappear.

#### **Available Subcategories**

- Maximum Temperature
- Minimum Temperature
- Mean Temperature
- Total Precipitation
- Total Snowfall
- Snow Depth
- Heating Degree Days

- Cooling Degree Days
- Maximum Wind
- Maximum Wind Gust
- Resultant Wind (NWWS only)
- Average Wind Speed
- Maximum Relative Humidity (not available for mon/sea/ann NWR)
- Minimum Relative Humidity (not available for mon/sea/ann NWR)
- Mean Relative Humidity (not available for mon/sea/ann NWR)
- Possible Sunshine (NWWS only) (percent of possible sunshine for day based on total minutes of sun and total minutes of sun possible)
- Sky Cover (NWWS only) (average for the day)
- Weather Types (NWWS only) (observed weather for the day)

Also available are temperature normals and extremes and sunrise and sunset for the day following the observation day.

The subcategories are further divided into options which are described below. Some of the options are common to several subcategories while a few are only available to certain subcategories.

### Common Options

- **Time/Date of Occurrence.** The forecaster can specify to include the weather elements observation time via this option.

**NOTE:** For wind and wind gust, time/date in the maximum column will be selectable for the NWR Daily Report, but not for the NWWS Daily Report.

- **Normal.** This option is for the inclusion of daily normal/mean values.
- **Departure.** This option is to include the observed weather element's departure from normal.
- **Record.** The extreme/record for the day can be included via this option.
- **Date/Year.** This option is for the inclusion of the year(s) in which record events occurred. Up to 3 years are stored in the database.
- **Last Year's.** Last year's value for the chosen element.

**NOTE:** For Daily NWR products, normal values cannot be included without the departure from normal value.

### Other Options

- **Include Temp in deg C?** Select this option to add the temperature in degrees Celsius to the Daily Climatological Report. This will only appear when configuring an NWR report; it is not available for NWS reports.

**NOTE:** This only displays temperature in degrees Celsius in the CRS output and does not affect the NWS output.

- **Month to Date (MTD).** This option is available for precipitation, snowfall, and degree days and includes the total amount of the chosen element during the month up to and including the observation day.
- **Season to Date (STD).** This option is available for precipitation, snowfall, and degree days and includes the total amount of the chosen element for the current season. Remember that the precipitation season can be defined as an alternate annual period, such as 1 September through 31 August.
- **Year to Date (YTD).** This option is available for precipitation, snowfall, and degree days and includes the total amount of the chosen element for the current year. Notice that this option appears as “Since July 1” for heating degree days and “Since January 1” for cooling degree days.

**NOTE:** The toggle buttons **Normal**, **Departure**, and **Last Year’s** control the normal, departure, and the previous year’s reports for MTD, STD, and YTD sums in addition to the measured values. For instance, choosing the MTD sum as well as the departure will result in the MTD sum and departure from normal of the sum both being included.

### Additional Options

You can choose from several additional options when setting up the monthly, seasonal, and annual climate product. They include Temperature, Precipitation, Snowfall, and Degree Days options.

#### *Temperature Options*

- **Avg. Daily Max.** Include the average daily maximum temperature for the mon/sea/ann.
- **Avg. Daily Min.** Include the average daily minimum temperature for the mon/sea/ann.
- **Days Max GE 90° F.** Include the number of days where the temperature was greater than or equal to 90 degrees Fahrenheit. This value is a set value within Climate.
- **Days Max LE 32° F.** Include the number of days where the temperature was less than or equal to 32 degrees Fahrenheit. This is a set value within Climate.



- **Days GE <forecaster-defined\_value>° F.** Include the number of days the maximum temperature was greater than or equal to a forecaster-defined value. The value can be set by accessing the **Edit User-Defined Values GUI** from the **Climate Parameters GUI** or the **Report Format GUI**.
- **Day LE <forecaster-defined\_value>° F.** Include the number of days the maximum temperature was less than or equal to a forecaster-defined value. The value can be set by accessing the **Edit User-Defined Values GUI** from the **Climate Parameters GUI** or the **Report Format GUI**.
- **Days Min LE 32° F.** Include the number of days where the minimum temperature was less than or equal to 32 degrees Fahrenheit. This value is a set value within Climate.
- **Days Min LE 0° F.** Include the number of days where the minimum temperature was less than or equal to 0 degrees Fahrenheit. This value is a set value within Climate.
- **Days GE <forecaster-defined\_value> F.** Include the number of days the minimum temperature was greater than or equal to a forecaster-defined value. The value can be set by accessing the **Edit User-Defined Values GUI** from the **Climate Parameters GUI** or the **Report Format GUI**.
- **Days LE <forecaster-defined value> F.** Include the number of days the minimum temperature was greater than or equal to a forecaster-defined value. The value can be set by accessing the **Edit User-Defined Values GUI** from the **Climate Parameters GUI** or the **Report Format GUI**.

### *Precipitation Options*

- **Average Daily.** Include the average daily amount of precipitation.
- **Storm Max.** Include the storm maximum amount of precipitation.
- **24 Hour Max.** Include the 24-hour maximum amount of precipitation.
- **Days GE 0.01 in.** Include the number of days where the amount of liquid precipitation was greater than or equal to 0.01 inches.
- **Days GE 0.10 in.** Include the number of days where the amount of liquid precipitation was greater than or equal to 0.10 inches.
- **Days GE 0.50 in.** Include the number of days where the amount of liquid precipitation was greater than or equal to 0.50 inches.
- **Days GE 1.00 in.** Include the number of days where the amount of liquid precipitation was greater than or equal to 1.00 inch.
- **Days GE <forecaster-defined\_value> F.** Include the number of days where the amount of liquid precipitation was greater than or equal to a forecaster-defined value (in inches). The value can be set by accessing the **Edit User-Defined Values GUI** from the **Climate Parameters GUI** or the **Report Format GUI**.

*Snowfall Options*

- **Depth Average.** Include the average snow depth during the mon/sea/ann.
- **Tot Since Jul 1.** Include the total snowfall since 1 July.
- **Depth Maximum.** Include the deepest snow depth during the mon/sea/ann.
- **Days Any Snow.** Include the number of days with snowfall greater than a trace.
- **Days GE 1.0 in.** Include the number of days the snowfall was greater than or equal to 1.0 inch. This is a set value within Climate.
- **Days GE <forecaster-defined\_value>F.** Include the number of days the snowfall was greater than or equal to a forecaster-defined value (in inches) of liquid precipitation. The value can be set by accessing the **Edit User-Defined Values GUI** from the **Climate Parameters GUI** or the **Report Format GUI**.
- **Water Equiv.** Include the water equivalent amount of snowfall.
- **WE Since Jul 1.** Include the water equivalent amount of snowfall since 1 July.
- **Storm Max.** Include the storm maximum amount of snowfall.
- **24 Hour Max.** Include the 24-hour maximum amount of snowfall.

*Degree Days Options*

- **Freeze Dates.** Include the earliest and latest freeze dates for the mon/sea/ann.
- **Average Sky Cover.** Include the average sky cover for the mon/sea/ann.

**Creating Products**

All toggle buttons can be turned on and off to achieve the desired set of elements for the product being created. When editing an existing product, simply toggle the elements which need to be changed.

Once all parameters for the product have been entered or chosen, select the **Save Product** button to accept parameters.

If a product is no longer needed, choose **Delete Product** to remove it from the database.

Selecting **Close** will return the forecaster to the **Climate Master GUI**.

**9.2 Record Climate**

The **recordClimate** process performs the basic “record report” (RER) functionality required by AWIPS. **recordClimate** is an extension to the current **Climate** functionality. If a Record is set in the **Climate** process, **recordClimate** will recognize this and produce a formatted RER and store it in the **fxatext** database. A forecaster can then retrieve this product from the database via the **Text WS** or **nwrEditor** for data verification and subsequent offsite dissemination.

The recordClimate process performs three basic operations:

1. Formats of Record Climate Reports
2. Stores Record Climate Reports in the **fxatext** database (CCCRERXXX)
3. Notifies forecaster (local/System) that a record has been set.

**NOTE:** Distribution and verification of products from the AWIPS **fxatext** database are accomplished manually via the **TextWS (WAN)** and **nwrEditor (CRS)**.

### 9.2.1 Configuration Files and Environment Variables

Table 9.2.1-1 shows the environment variables used in discussing the Climatological Reports Formatter. These variables are defined for user fxa and individual user accounts.

**Table 9.2.1-1. Environment Variables in Record Climate**

| Environment Variable Name | Environment Variable Path      |
|---------------------------|--------------------------------|
| CLIMATE_DIR               | /awips/adapt/climate           |
| FXA_DATA                  | /data/fxa                      |
| FXA_HOME                  | /awips/fxa                     |
| LOG_DIR                   | /data/logs/fxa                 |
| CLIMATE_BIN_DIR           | /awips/adapt/climate/bin/Linux |

The following files are used by the **recordClimate** process.

#### **recordClimate.cfg**

This file is located in the **\$CLIMATE\_DIR/data** directory and is used for forecaster notification configuration settings on initial startup. The configuration file consists of the following data:

```
<Display Type>
<Importance>
<Audio Alert File>
```

Each is on a line by itself as shown in this example:

```
SYSTEM
URGENT
/awips/fxa/data/sounds/beep.au
```

#### **RecordClimateRawData.dat**

This file will be created in the **\$CLIMATE\_DIR/tmp** directory. It is used to pass data from **Climate** to **recordClimate** when a climatic record event occurs. The file will not be created if no records are broken, and it will be deleted after **recordClimate** has read it.

**RecordClimateStationInfo.dat** This file will be created in the **\$CLIMATE\_DIR/tmp** directory. It is used to pass data from **Climate** to **recordClimate** when a climatic record event occurs. The file will not be created if no records are broken. Upon completion of **recordClimate**, the file will be deleted.

```
afos2awips.txt
awipsPriorities.txt
NWS_exclude_XXX.txt
nwr.cfg
nwsDeviceName.txt
rcv_handler.tbl
textNotificationServerClientList.txt
NWSschedulerHost.txt
```

## 9.2.2 Processes

```
LX    Climate
LX    recordClimate
PX1   textNotificationServer
LX    fxaAnnounce
LX    textWish
PX1   MhsServer
PX1   NWSProduct
PX1   NWSSchedule
LX    nwrEditorWish
LX    transferNWR
PX1   nwrTrans.pl
PX1   senttoNWR
```

Refer to Exhibit 9.2.2-1 for the Record Climate data flow diagram.

**Climate** Exhibit 9.1.3-1, Climatological Reports Formatter for NWR and NWS (Daily), shows the **Climate** process. When a record is set in the **Climate** process, the information necessary to form Record Reports is written to the two data files, **RecordClimateRawData.dat** and **RecordClimateStationInfo.dat**.

**recordClimate** The **recordClimate** process is launched during each climate run. It will check for existence of two files, **RecordClimateRawData.dat** and **RecordClimateStationInfo.dat**, created by **create\_climate**. Upon encountering these two files, **recordClimate** will create and store a record report (RER) product in the **fxatext** database and notify the forecaster that a record report exists.

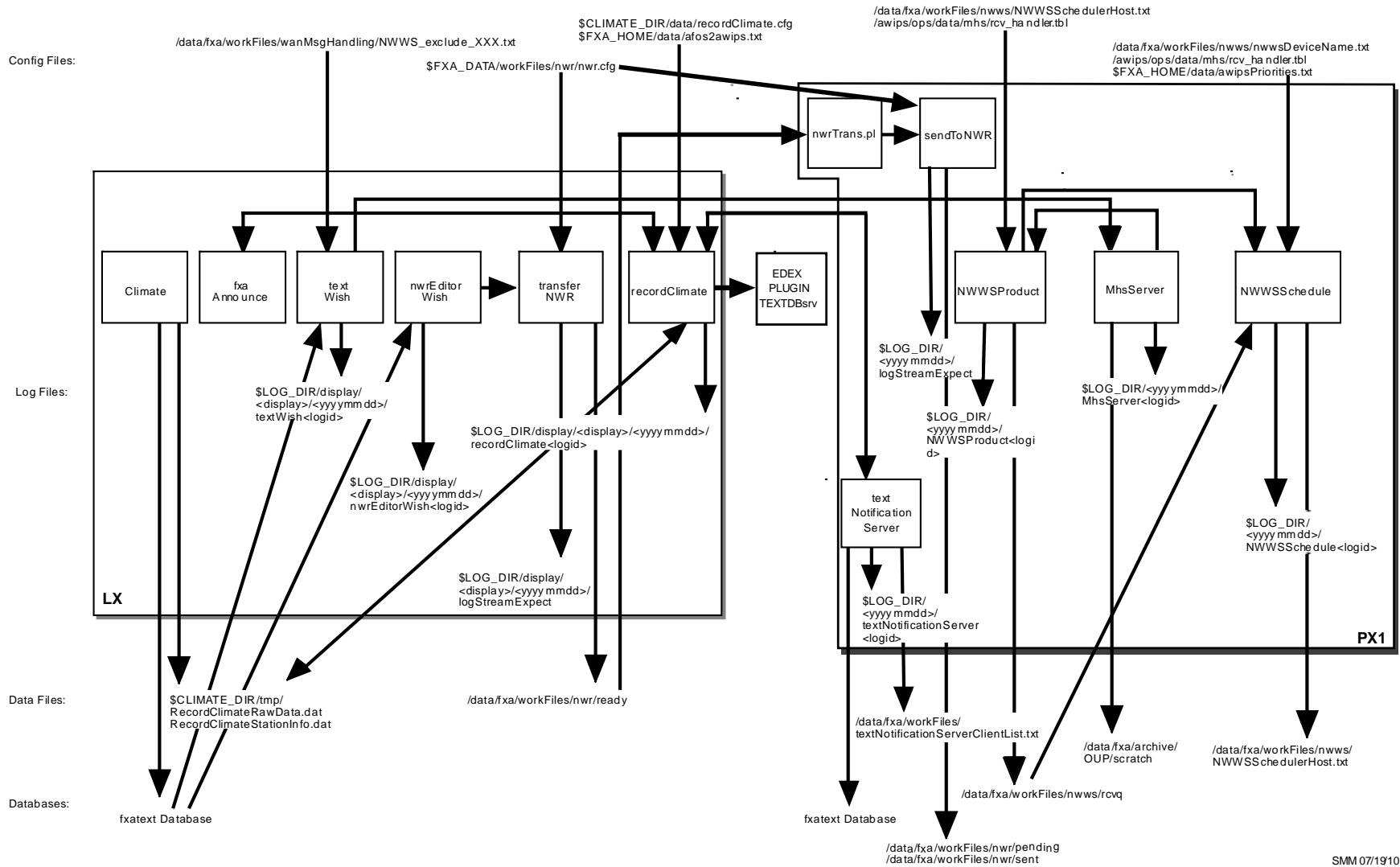

SMM 07/19/10

Exhibit 9.2.2-1. Record Climate Data Flow

► **To View the Current Day's recordClimate Log**

On LX1 as user fxa,

**TYPE:** `cd $LOG_DIR/display/<display>/<yyyymmdd>`

- Where `<yyyymmdd>` is today's date and `<display>` is the current display variable (e.g., `lx1-tbdw:0`).

**TYPE:** `ls -ltr recordClimate*`

- Displays the current day's **recordClimate** logs from earliest to latest.

**TYPE:** `tail -f <logname>`

- Displays the log as it updates with the latest messages.

### Log Message Format

An entry in the log should look like the following:

```
LOG-STATUS: Log file opened on host lx1-tbdw3 at Mon Aug 29 12:28:55 2006
12:28:55:824 recordClimate.C EVENT: Checking to see if records are broken...

12:28:55:834 recordClimate.C EVENT: Checking for
/awips/adapt/climate/tmp/RecordClimateRawData.dat and
/awips/adapt/climate/tmp/RecordClimateStationInfo.dat
12:28:55:835 recordClimate.C EVENT: missing
/awips/adapt/climate/tmp/RecordClimateRawData.dat OR
12:28:55:836 recordClimate.C EVENT:
awips/adapt/climate/tmp/RecordClimateStationInfo.dat
12:28:55:837 recordClimate.C EVENT: No need to run recordClimate...Skipping...
~
```

The log consists of the following fields:

Time stamp	12:28:55:837
File name	recordClimate.C
Message type	EVENT:
Message string	No need to run recordClimate...Skipping...

The logs are purged by the **scour** script after 2 days and the empty directories are removed by the **master.purge** script.

### textNotificationServer

The **textNotificationServer** process runs on PX1 and sends out notification messages to each of its registered clients for every text product written to the text database. The notification message identifies each product received by its nine-letter product ID. The process creates a data file, **textNotificationServerClientList.txt**, which identifies the processes registered with the **textNotificationServer**. When a product of interest is stored in the text database, it notifies **recordClimate**.

- ▶ **To View the Current Day’s textNotificationServer Log  
On PX1 as user fxa,**

**TYPE:** `cd $LOG_DIR/<yyyymmdd>`  
 ▪ Where `<yyyymmdd>` is today’s date.

**TYPE:** `ls -ltr textNotificationServer*`  
 ▪ Displays the current day’s **textNotificationServer** logs from earliest to latest.

**TYPE:** `tail -f <logname>`  
 ▪ Displays the log as it updates with the latest messages.

### Log Message Format

An entry in the log should look like the following:

```
18:42:47.480 TextNotificationServer.C EVENT: SFORERSFO notif rcvd
```

The log consists of the following fields:

Time stamp	18:42:47.480
File name	TextNotificationServer.C
Message type	EVENT:
Message string	SFORERSFO notif rcvd

The logs are purged by the **scour** script after 2 days and the empty directories are removed by the **master.purge** script.

### fxaAnnounce

The **fxaAnnounce** process produces the text that displays on the appropriate fxa status line according to the “displayer” (LOCAL, SYSTEM, RADAR) and “importance” (SIGNIFICANT, ROUTINE, URGENT) characteristics.

### TextDB\_Server

The **recordClimate** process makes a request to the EDEX plug-in called TextDBSrv. It runs in the EDEX Request. The log messages can be found on edex-request.log.

### textWish

The **textWish** process uses **textWindow.tcl** to create a text window so the forecaster can retrieve the record report product from the database. Upon verification of the product, it calls **MhsServer** to disseminate the report to the WAN.

- ▶ **To View the Current Day’s textWish Log  
On the workstation, in a Terminal window,**

- TYPE:** `cd $LOG_DIR/display/<display>/<yyyymmdd>`
- Where `<yyyymmdd>` is today's date and `<display>` is the current display variable (e.g., `lx1-tbdw:0`).
- TYPE:** `ls -ltr textWish*`
- Displays the current day's **textWish** logs from earliest to latest.
- TYPE:** `tail -f <logname>`
- Displays the log as it updates with the latest messages.

### Log Message Format

An entry in the log should look like the following:

```
textWish 8803 1030732899.962823 18:41:39.962 EVENT: textWish 8803 app
initialized
textWish 8803 1030732965.365089 18:42:45.365 EVENT: Reading
/data/fxa/workFiles/wanMsgHandling/NWWS_exclude_STO.txt
textWish 8803 1030732965.400578 18:42:45.400 EVENT: SXUS99 KSFO 121842
[SFORERSFO] sent to DEFAULTINCF,NWWSUP via MhsServer
textWish 8803 1030732967.515203 18:42:47.515 EVENT: SXUS99 KSFO 121842
[SFORERSFO] written to db
textWish 8803 1030734019.668409 19:00:19.668 PROBLEM: textWish encountered XIO
error 32: Broken pipe on display aprfc:22.0
textWish 8803 1030734019.730314 19:00:19.730 PROBLEM: after 7923 requests,
with 7872 processed, 0 remaining.
textWish 8803 1030734019.730754 19:00:19.730 EVENT: textWish interpreter 8803
exiting.
```

The log consists of the following fields:

Time stamp	18:42:45.365
File name	textWish
Message type	EVENT:
Message string	Reading /data/fxa/workFiles/ wanMsgHandling/NWWS_exclude_STO.txt

The logs are purged by the **scour** script after 2 days and the empty directories are removed by the **master.purge** script.

### MhsServer

The **MhsServer** process on PX1 registers a call-back function that will handle products sent from the text workstation, declares an IPC address, and enters a dispatch loop waiting for messages. A notification is sent to the **MhsServer** process consisting of the WMO header and the file name slated for distribution. Module **MhsWfoProduct** sends the product to the WAN, NWWSUP while it archives the file in the `/data/fxa/archive/OUP/scratch` directory.

#### ► To View the Current Day's MhsServer Log

On the PX1 as user fxa or your individual user account,



- TYPE:** `cd $LOG_DIR/<yyyymmdd>`
- Where **<yyyymmdd>** is today's date.
- TYPE:** `ls -ltr MhsServer*`
- Displays the current day's **MhsServer** logs from earliest to latest.
- TYPE:** `tail -f <logname>`
- Displays the log as it updates with the latest messages.

### Log Message Format

An entry in the log should look like the following:

```
18:42:46.231 MhsWfoProduct.C EVENT: SXUS99 KSFO 121842 [SFORERSFO] sent to
DEFAULTINCF: msg id = TBDW-153708
18:42:46.559 MhsWfoProduct.C EVENT: SXUS99 KSFO 121842 [SFORERSFO] sent to
NWWSPUP
18:42:46.660 MhsWfoProduct.C
EVENT:/data/fxa/archive/OUP/scratch/KSFORERSFO.wan 20060512_184245
successfully archived
19:00:19.755 DataSocket.C DEBUG: Connection to lx1-tbdw/2573/8803 has been
closed by the peer.
19:00:19.774 DataSocket.C DEBUG: Closing the socket to lx1-tbdw/2573/8803
```

The log consists of the following fields:

Time stamp	18:42:46.660
File name	MhsWfoProduct.C
Message type	EVENT:
Message string	/data/fxa/archive/OUP/scratch/KSFORERSFO.wan 20060512_184245 successfully archived

The logs are purged by the **scour** script after 2 days and the empty directories are removed by the **master.purge** script.

### NWWSProduct

The process stores the record report it received from **MhsServer** in the **/data/fxa/workFiles/nwws/rcvq** directory and opens a socket to **NWWSchedule** to transfer the message.

#### ► To View the Current Day's NWWSProduct Log

On PX1 as user fxa,

- TYPE:** `cd $LOG_DIR/<yyyymmdd>`
- Where **<yyyymmdd>** is today's date
- TYPE:** `ls -ltr NWWSProduct*`
- Displays the current day's **NWWSProduct** logs from earliest to latest

**TYPE:** `tail -f <logname>`

- Displays the log as it updates with the latest messages

### Log Message Format

An entry in the log should look like the following:

```
18:42:52.580 nwwsProduct.C EVENT: Received message: 0056 SFORERSFO
/data/fxa/workFiles /nwws/rcvq/TBDW-153708.001
18:42:52.867 nwwsProduct.C EVENT: Product sent to NWWSSchedule via socket
```

The log consists of the following fields:

Time stamp	18:42:52.867
File name	nwwsProduct.C
Message type	EVENT:
Message string	Product sent to NWWSSchedule via socket

The logs are purged by the **scour** script after 2 days and the empty directories are removed by the **master.purge** script.

### NWWSSchedule

The **NWWSSchedule** process creates a socket to communicate and receive products with **NWWSPRODUCT**, validates product ID, maintains product queues, disseminates the products by forking **NWWSTRANSMIT** and cleans up product files upon successful transmission.

#### ► To View the Current Day's NWWSSchedule Log

On PX1 as user **fxa**,

**TYPE:** `cd $LOG_DIR/<yyyymmdd>`

- Where **<yyyymmdd>** is today's date.

**TYPE:** `ls -ltr NWWSSchedule*`

- Displays the current day's **NWWSSchedule** logs from earliest to latest.

**TYPE:** `tail -f <logname>`

- Displays the log as it updates with the latest messages.

### Log Message Format

An entry in the log should look like the following:

```
18:42:52.906 nwwsScheduler.C EVENT: message receive: 0056 SFORERSFO
/data/fxa/workFiles/nwws/rcvq/TBDW-153708.001
18:42:52.936 nwwsScheduler.C EVENT: RER is not found in nwwsProductPriority table.
Default priority is used
18:42:52.937 nwwsScheduler.C EVENT: Start transmitting product in queue
```

```
18:42:54.267 nwwsScheduler.C EVENT: SFORERSFO
/data/fxa/workFiles/nwws/rcvq/TBDW-153709.001 has been successfully transmitted
```

The log consists of the following fields:

```
Time stamp      18:42:54.267
File name       nwwsScheduler.C
Message type    EVENT:
Message string   SFORERSFO
                /data/fxa/workFiles/nwws/rcvq/TBDW-153709.001
                has been successfully transmitted
```

The logs are purged by the **scour** script after 2 days and the empty directories are removed by the **master.purge** script.

### nwrEditorWish

The **nwrEditorWish** process has been extended to include NWR application-specific commands and executes the **nwrEditor** script to provide the GUI access. The forecaster is allowed to remotely control NWR from an AWIPS workstation to monitor product transfer from AWIPS to NWR. The **nwrEditorWish** process provides a last-minute edit capability for products which are to be sent to the NWR from AWIPS.

#### ► To View the Current Day's nwrEditorWish Log

On the LX,

```
TYPE:      cd $LOG_DIR/display/<display>/<yyyymmdd>
             ■ Where <yyyymmdd> is today's date and <display> is the
               current display variable (e.g., lx2-tbdw:0).
```

```
TYPE:      ls -ltr nwrEditorWish*
             ■ Displays the current day's nwrEditorWish logs from
               earliest to latest.
```

```
TYPE:      tail -f <logname>
             ■ Displays the log as it updates with the latest messages.
```

### Log Message Format

An entry in the log should look like the following:

```
LOG-STATUS: Log file opened on host lx2-tbdw at Wed May 12 18:49:26 2006
nwrEditorWish 9100 1030733366.848139 18:49:26.848 PROBLEM: unable to send
voice ready product to crs _sendToCrs failed
nwrEditorWish 9100 1030733366.851436 18:49:26.851 PROBLEM: could not send
voice ready product to crs
nwrEditorWish 9100 1030733366.851809 18:49:26.851 PROBLEM: voice ready product
NOT SENT to crs
nwrEditorWish 9100 1030733989.540121 18:59:49.540 EVENT: textWish interpreter
9100 exiting.
```

The log consists of the following fields:

```

Time stamp      18:49:26.848
File name       nwrEditorWish
Message type    PROBLEM:
Message string  unable to send voice-ready product to crs
                _sendToCrs failed

```

The logs are purged by the **scour** script after 2 days and the empty directories are removed by the **master.purge** script.

## transferNWR

The **transferNWR** script is responsible for transferring voice-ready products to a holding area where they will be picked up and sent to NWR. The **transferNWR** script is a command-line interface, which provides the forecaster with three options:

**transferNWR -a [filename]** This option will automatically transfer the file from the source directory to the `/data/fxa/workFiles/nwr/ready` directory. The full pathname of the file must be given so that the file can first be copied into the source directory. The **transferNWR** script then monitors the `$FXA_DATA/workFiles/nwr/pending` directory to verify that the product has been successfully sent to CRS by the **sendToNWR** script.

**transferNWR -d [filename]** This option will also ensure that the file is copied into the source directory, but the file will not be transferred. This option is for cases where the forecaster would first like to inspect or edit the product before it is sent.

**transferNWR -n** This option sends a warning message to the local workstation that there has been a problem in transmitting the file. This message is sent at the forecaster's discretion, based upon the return and exit values issued by this script.

The **transferNWR** script is forked by a parent process, **NWRBrowser**. The **transferNWR** script returns one of two values to the parent process. The values are as follows:

**Value = 0 indicates all was successful**

**Value = 1 indicates that the transfer may have failed**

Log files can be viewed from the **NWRBrowser**. The most current log is listed last. Logs can also be viewed by other text editors, such as the **vi** editor.

### ► To View the Current Day's transferNWR Log

On the workstation,

**TYPE:** `cd $LOG_DIR/display/<display>/<yyyymmdd>`

- Where `<yyyymmdd>` is today's date and `<display>` is the current display variable (e.g., `lx1-tbw4:0`).

**TYPE:** `ls -ltr logStreamExpect*`

- Displays the current day's **transferNWR** logs from earliest to latest.

**TYPE:** `tail -f <logname>`

- Displays the log as it updates with the latest messages.

### Log Message Format

An entry in the log should look like the following:

```
LOG-STATUS: Log file opened on host lx1-tbw4 at Wed May 12 18:19:05 2006
18:19:05.358 TclLogStream.C EVENT: File
/data/fxa/workFiles/nwr/pending/PITHWRNW1 will be automatically transferred
18:19:05.359 TclLogStream.C EVENT: /data/fxa/workFiles/nwr/pending/PITHWRNW1
has been copied to data/fxa/workFiles/nwr/ready/PITHWRNW1 for processing by
sendToNWR.
```

**NOTE:** Check the `logStreamExpect` log on PX for information about the transfer of `data/fxa/workFiles/nwr/pending/PITHWRNW1` to CRS.

The log consists of the following fields:

Time stamp	18:19:05.358
File name	TclLogStream.C
Message type	EVENT:
Message string	File /data/fxa/workFiles/nwr/pending/PITHWRNW1 will be automatically transferred

The `scour` script purges the logs after 2 days, and the empty directories are removed by the **master.purge** script.

### nwrTrans.pl

The **nwrTrans.pl** (on PX1) Perl script is a persistent script that looks in `/data/fxa/workFiles/nwr/ready` every couple of seconds to find files that have been placed there by either the **NWRBrowser** or **nwrEditor** GUIs when a user requests to send a product to the CRS for broadcast on the NOAA Weather Radio. This script then calls **transferNWR** for any files that were found. Previously, **transferNWR** was called directly from the **NWRBrowser** or **nwrEditorWish**.

### sendToNWR

Voice-ready text is transmitted from AWIPS to the NWR by the **sendToNWR Expect** script. In addition to transferring the product, copies can be kept in one of two directories:

```
$FXA_DATA/workFiles/nwr/pending
$FXA_DATA/workFiles/nwr/sent
```

The **sendToNWR** script is called from the **nwrTrans.pl** script, which is a persistent **fxa** process that checks the **/data/fxa/workFiles/nwr/ready** directory every 2 seconds for products placed there by the **transferNWR** script. When **nwrTrans.pl** finds a file, or files, in this directory, it calls **sendToNWR** for each file.

The **sendToNWR** script is responsible for transferring voice-ready products from AWIPS to the NWR. The **sendToNWR** script is a command-line interface that provides the forecaster with three options:

**sendToNWR -a [filename]** This option will automatically transfer the file from the source directory on AWIPS to the destination directory on the CRS. The full pathname of the file must be given so that the file can first be copied into the source directory.

**sendToNWR -d [filename]** This option will also ensure that the file is copied into the source directory, but the file will not be transferred. This option is for cases in which the forecaster would first like to inspect or edit the product before it is sent.

**sendToNWR -n** This option sends a warning message to the local workstation that there has been a problem in transmitting the file. This message is sent at the forecaster's discretion, based upon the return and exit values issued by this script.

**NOTE:** The **transferNWR** script also may continue to be used for the **-d** and **-n** options.

When **sendToNWR** is invoked, the product is automatically copied to the **pending** directory. If successfully sent, the product is moved to the **sent** directory. The contents of each directory can be viewed in the windowpane dedicated to that directory. Products not successfully transmitted will remain in the **pending** directory.

► **To View the Current Day's sendToNWR Log**

On PX1, as user **fxa**,

**TYPE:** `cd $LOG_DIR/<yyyymmdd>`  
 ▪ Where **<yyyymmdd>** is today's date.

**TYPE:** `ls -ltr logStreamExpect`  
 ▪ Displays the current day's **sendToNWR** log.

**TYPE:** `tail -f <logname>`

- Displays the log as it updates with the latest messages.

### Log Message Format

An entry in the log should look like the following:

```
18:19:05.358 TclLogStream.C EVENT: File /data/fxa/workFiles/nwr/pending/PITHWRNW1 will be
automatically transferred
18:19:06.012 TclLogStream.C EVENT: Successful ping to OMP
18:19:06.368 TclLogStream.C EVENT: Successful ping to 5MP
18:19:09.802 TclLogStream.C EVENT: Master processor is OMP
18:19:11.746 TclLogStream.C EVENT: transfer complete to OMP
18:19:11.899 TclLogStream.C EVENT: Successful transfer of
/data/fxa/workFiles/nwr/pending/PITHWRNW1 to OMP
```

The log consists of the following fields:

Time stamp	18:19:05.358
File name	TclLogStream.C
Message type	EVENT:
Message string	File /data/fxa/workFiles/nwr/pending/PITHWRNW1 will be automatically transferred

The scour script purges the logs after 2 days and the empty directories are removed by the **master.purge** script.

### 9.3 *Hourly Weather Roundup Formatter for the NOAA Weather Wire Service (NWWS)*

The HWR is a summary of the current weather observations for locations in and around the local area including marine observations for those WFOs with coastal responsibilities.

The HWR NWWS formatter application prepares tabular products for the NWWS. The formatted products are automatically sent to the NWWS.

The HWR uses:

- METAR observations
- Marine observations
- SCD
- Satellite Cloud Product (SCP).

The HWR NWWS application (**hwrnwws**) performs calculations on hourly weather data, both land and marine, constructs the product, and stores the resultant text files into a temporary target directory. From the temporary directory, the product is automatically sent to the NWWS. The **transferNWWS.pl** script sends the completed files over the WAN to the site's NWWS uplink site for distribution to the NWWS via the uplink site's NWWS asynchronous interface port.

**NOTE:** The forecaster-entered **METARINT** value in the **nwws.config** file specifies the number of minutes before the hour at which to start including the METAR observations in the HWR. The HWR considers any observations from H-METARINT up to but not including H+(60-METARINT) as an observation for the nominal hour. For example, if the METARINT value is 15, observations at 0845Z are considered 0900Z observations, but observations at 0840Z are considered 0800Z observations. So, if an observation comes in at H+0:40, then at the top of the hour HWR will consider that observation to be from the last hour and reject it.

The **NWWS** selection in the **Product Setup** section of the HWR main GUI permits the forecaster to create a station listing and make configuration and threshold selections.

### 9.3.1 Configuration Files and Environment Variables

#### Environment Variables

The following environment variables are referenced in this chapter for user **fxa** and individual user accounts; their full paths are provided as follows:

```
$LOG_DIR           /data/logs/fxa
$FXA_HOME          /awips/fxa
$FXA_DATA          /data/fxa
```

#### Configuration Files

##### **nwws.config**

The **nwws.config** configuration file contains the list of products to be produced for the NWWS. It resides in the **/awips/adapt/hwr/etc/nwws** directory. An example of an **nwws.config** file is shown in Exhibit 9.3.1-1.

```
SCRIPT /awips/fxa/bin/transferNWWS.pl
DESTDIR /data/fxa/workFiles/nwws
# product list. The following product will be generated:
METARINT 15 # minutes before the hour at which to start using METAR's in
HWR
PRODUCT PITSWRPA
PRODUCT PITSWRPA1
PRODUCT PITSWRPA2
```

**Exhibit 9.3.1-1. Example nwws.config File**

##### **awipsPriorities.txt**

The **awipsPriorities.txt** configuration file contains a table with AFOS product categories (NNN) and corresponding priorities. The values in the first column are the product categories; those in the second column are the priorities. The file resides in the **\$FXA\_HOME/data** directory. An example of an **awipsPriorities.txt** file follows:

```
ACR 1
AWG 2
```



```

AWU 1
AWW 2
BOT 1
CEM 2
CWA 1
FFA 1
FLW 2

```

**afos2awips.txt**

The **afos2awips.txt** configuration file is used to convert the AFOS site ID into the AWIPS site ID. The first column contains the AFOS ID. The second column contains the World Meteorological Organization (WMO) header ID. The third column contains the AWIPS site ID. The file resides in the **\$FXA\_HOME/data** directory. An excerpt of this file follows:

```

ABNNPWAPN WWUS45 KAPN
ABNWSWAPN WWUS46 KAPN
ABQADAABQ NOUS45 KABQ
ABQADACAO NOUS45 KABQ
ABQADAROW NOUS45 KROW
ABQADAZAB NOUS45 KZAB
ABQADMABQ NOUS45 KABQ

```

**siteCommission.txt**

This configuration file contains the AWIPS site's commissioning status and is a holdover from the precommissioned phase. The file contains a **1** if the site is commissioned and a **0** if it is not yet commissioned. All operational sites should have a **1** in this file.

**wmoSiteId.txt**

This configuration file is located in **/awips/fxa/data/localizationDataSets/LLL** (where **LLL** is the localization ID, usually the same as the site ID) and identifies the site's four letter AWIPS site ID.

**NWWS\_exclude\_XXX.txt**

This configuration file provides a list with NWWS products that will not be sent to the NWWS.

**siteCommission.txt**

This configuration file contains the AWIPS site's commissioning status and is a holdover from the precommissioned phase. The file contains a **1** if the site is commissioned and a **0** if it is not yet commissioned. All operational sites should have a **1** in this file.

**wmoSiteId.txt**

This configuration file is located in **/awips/fxa/data/localizationDataSets/LLL** (where **LLL** is the localization ID, usually the same as the site ID) and identifies the site's four letter AWIPS site ID.

**NWWS\_exclude\_XXX.txt** This configuration file provides a list with NWWS products that will not be sent to the NWWS.

### 9.3.2 Processes

```
PX1  hwrnwws
LX   hwrgui
LX   transferNWWS.pl
LX   handleOUP.pl
LX   distributeProduct
```

Exhibit 9.3.2-1 diagrams the Hourly Weather Roundup Formatter for NWWS data flow.

#### **hwrnwws**

The **hwrnwws** process requires the following input:

- Decoded marine observations from netCDF files
- Decoded METAR observations from the text database (**fxatext**)
- SCD and SCP data from the text database (**fxatext**)
- Setup data, which includes the station lists and marine selections from the **CCCSWRXXX.setup**, and **CCCSWRXXX.product** files
- Configuration information from the **nwws.config** file.

The **hwrnwws** process performs calculations on both land and marine hourly weather data, constructs the product, and stores the resultant text files in a temporary target directory. The **transferNWWS.pl** script sends the completed files to all sites across the AWIPS WAN via the NCF which distributes them to the NWWS primary and backup sites where it is uplinked.

#### ► **To View the Current Day's hwrnwws Log**

On PX1, as user fxa or your individual user account,

**TYPE:**        `cd $LOG_DIR/<yyyymmdd>`  
                   ▪        Where **<yyyymmdd>** is today's date.

**TYPE:**        `ls -ltr hwrnwws*`  
                   ▪        Displays the current day's **hwrnwws** logs from earliest to latest.

**TYPE:**        `tail -f <logname>`  
                   ▪        Displays the log as it updates with the latest messages.

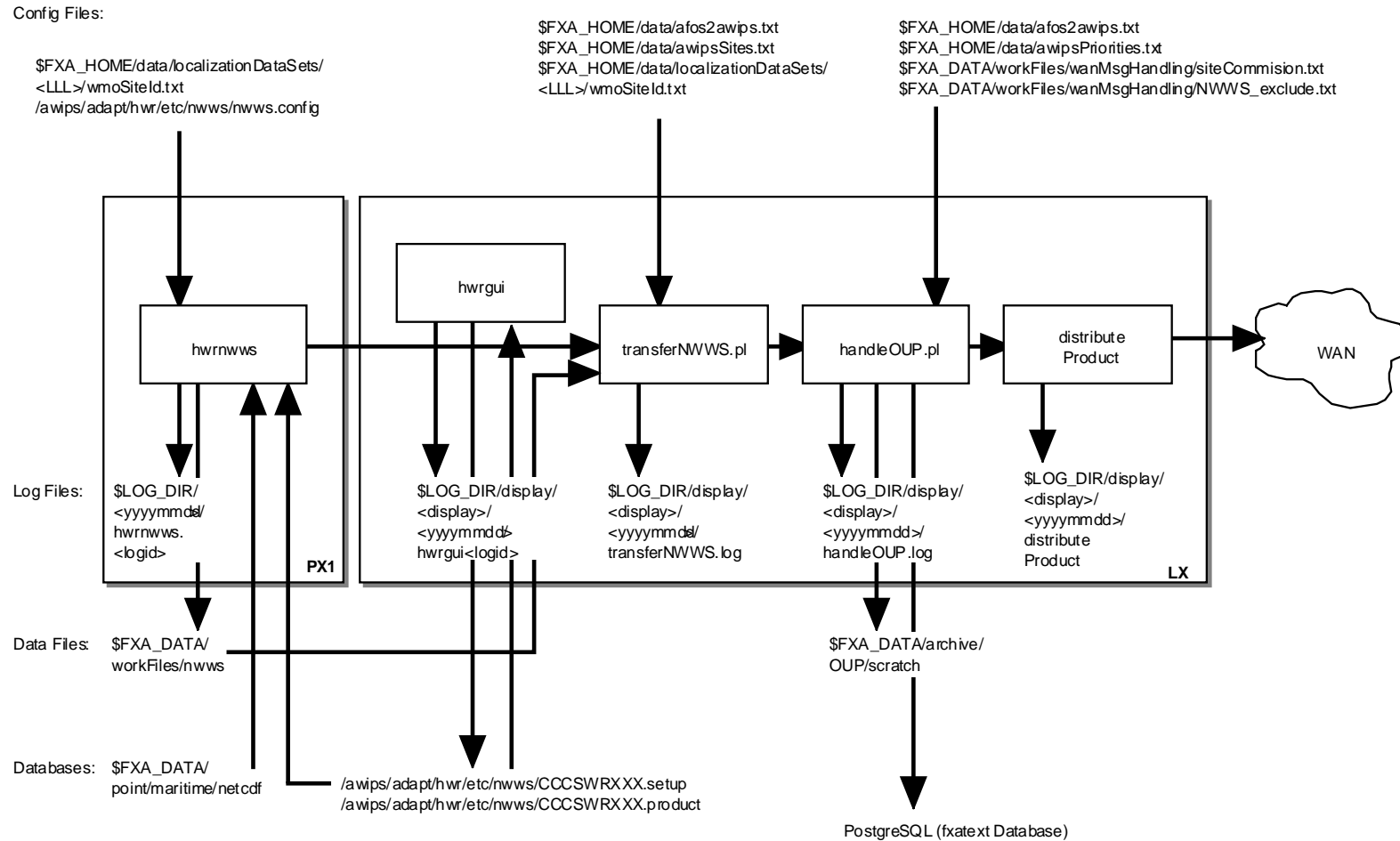

SMM83005

**Exhibit 9.3.2-1. Hourly Weather Roundup Formatter for NOAA Weather Wire Service**

## Log Message Format

An entry in the log should look like the following:

```
Traceback (most recent call last):
File "/awips/adapt/hwr/py/hwrnwsws.py", line 52, in ?
wxRoundup.GetFiles('nwsws', names)
File "/awips/adapt/hwr/py/wxRoundup.py", line 100, in getFiles pils =
Pils.restorePils()
File "/awips/adapt/hwr/py/Pils.py", line 18, in restorePils return
cPickle.load(open(PILFile))
IOError: [Errno 2] No such file or directory: 'etc/pil.data'
~
~
```

The logs are purged by the **scour** script after 2 days and the empty directories are removed by the **master.purge** script.

## hwrgui

The **hwrnwsws** process enables the forecaster to enter required/allowed configuration and threshold information through a GUI controlled by processes launched by the **hwrgui** process. Forecaster selections are validated and stored in the **CCCSWRXXX.setup** file.

The **NWWS** product setup process uses the station format editor to create the station list for each output product. Each list contains the METAR and SCD station identifier, the SCP station identifier, a symbol to indicate how to treat missing data, and the station name.

The product IDs and the station lists are stored in the **CCCSWRXXX.product** file.

### ► To View the Current Day's hwrgui Log

On the workstation as user fxa or your individual user account,

**TYPE:** `cd $LOG_DIR/display/<display>/<yyyymmdd>`

- Where **<display>** is the current display variable (e.g., lx1-tbw4:0) and **<yyyymmdd>** is today's date.

**TYPE:** `ls -ltr hwrgui*`

- Displays current day's **hwrgui** logs from earliest to latest.

**TYPE:** `tail -f <logname>`

- Displays the log as it updates with the latest messages.

## Log Message Format

An entry in the log should look like the following:

```
hwrgui 21509 924279088.572954 16:11:28.572 EVENT: HWRNWWSSetup::update()
succeeded
~
```

The log consists of the following fields:

```
Time stamp      16:11:28.572
Module name    hwrgui
Message type   EVENT:
Message string HWRNWWSSetup::update() succeeded
```

The logs are purged by the **scour** script after 2 days and the empty directories are removed by the **master.purge** script.

### transferNWWS.pl

The **transferNWWS.pl** script prepares a given product for WAN distribution by removing the one line communications header. The **\$FXA\_HOME/data/afos2awips.txt** file is read and used to convert the AFOS product identifier, extracted from the product contents, to an equivalent AWIPS identifier. The **transferNWWS.pl** script invokes the **handleOUP.pl** script.

#### ► To View the Current Day's transferNWWS Log

On the workstation as user fxa or your individual user account,

**TYPE:** `cd $LOG_DIR/display/<display>/<yyyymmdd>`

- Where **<display>** is the current display variable (e.g., lx1-tbw4:0) and **<yyyymmdd>** is today's date.

**TYPE:** `ls -ltr transferNWWS*`

- Displays the current day's **transferNWWS.pl** logs from earliest to latest.

**TYPE:** `tail -f <logname>`

- Displays the log as it updates with the latest messages.

### Log Message Format

An entry in the log should look like the following:

```
product = /data/fxa/workFiles/nwWS/SFOSWRCA
AFOS ID = SFOSWRCA
AFOS routing node = DEF
  -- Handling OUP
mapToAwipsID():
  Found match.
  awips ID = KSFOSWRCA
wan Command =
  handleOUP.pl -r DEF KSFOSWRCA /data/fxa/workFiles/nwWS/SFOSWRCA
Handling of OUP was successful.
Script done...
```

The logs are purged by the **scour** script after 2 days and the empty directories are removed by the **master.purge** script.



```

        Message to NWSUP successfully submitted.
createAwipsWANHeader():
    awips wan header =
ASUS46 KSFO 121210
SWRCA
createTargetFile():
    target product pathname = /tmp/SFOSWRCA
storeInTextDB():
    storeCommand =
    textdb -w SFOSWRCA < /tmp/SFOSWRCA
    Successful storage to text database.
archiveOUP():
moveFile(): /tmp/SFOSWRCA to
/data/fixa/archive/OUP/scratch/SFOSWRCA.20060512_121047
    /tmp/SFOSWRCA moved successfully...
    Successfully archived product
/data/fixa/archive/OUP/scratch/SFOSWRCA.20060512_121047
Script done....

```

### distributeProduct

The **distributeProduct** process creates a product message and submits it for distribution across the AWIPS WAN to the addressed sites. The **distributeProduct** process first prepares the product by creating the WAN communications header and prepending the header to a temporary copy of the product. Distribution requests, enclosing the temporary copy of the product, are subsequently made to the X.400 Message Handling System through the **msg\_send** utility program.

**TYPE:** `cd $LOG_DIR/display/<display>/<yyyymmdd>`

- Where **<display>** is the current display variable (e.g., lx1-tbw4:0) and **<yyyymmdd>** is today's date.

**TYPE:** `ls -ltr distributeProduct*`

- Displays the current day's **distributeProduct** logs from earliest to latest.

**TYPE:** `tail -f <logname>`

- Displays the log as it updates with the latest messages.

### Log Message Format

An entry in the log should look like the following:

```

12:10:42.004 MHSPProduct.C EVENT: Product request (KSFOSWRCA) was successfully
submitted to the MHS request server for distribution.
    Message Attributes:
    Request ID:  TBDW-35537
    To:  NWSUP
    Priority:  0
    Type:  Routine
    Subject:  SFOSWRCA
    Handling Action:  131
12:10:42.050 MHSPProduct.C EVENT:  TBDW-35537
~

```

### 9.3.3 *Setting up the HWR NWWS Application*

Before it can be used, the HWR NWWS application has to be set up (localized) for your site. There are two steps involved in setting up this application:

1. Specify the HWR NWWS Setup Product options.
2. Create a Station List.

**NOTE:** Setting up the HWR NWWS application only needs to be done for the initial application installation and when creating new product identifiers.

#### 9.3.3.1 *Identifying the Products to be Produced*

To identify the products to be produced, press the **NWWS** button in the **Product Setup** section of the hwr GUI. Either select an existing product and press **Load** or create a new product by typing the new product ID in the **Product Actions** section and press **Add**.

#### 9.3.3.2 *Setting Up the HWR NWWS Application*

To access the HWR Editor for NWWS from the System Control Menu, select **Background WFO Apps, Hourly Weather Roundup (HWR)** from the cascading menu. This will display the **Hourly Weather Roundup** GUI shown in Exhibit 9.3.3.2-1.



**Exhibit 9.3.3.2-1. The Hourly Weather Roundup GUI**

**Next, select NWWS** under the Product Setup on the HWR GUI. The **Hourly Weather Roundup** Editor for NOAA Weather Wire Service Product Setup (shown in Exhibit 9.3.3.2-2) will display.





Exhibit 9.3.3.2-2. The Hourly Weather Roundup for NOAA Weather Wire Service Product Setup

Once the HWR Editor for NWS has opened you will see the following setup options.

### Products

This scrolled list displays the products that may be converted to output products. Each product must contain a Station List file (editable via the Station Editor). Select a product and press **Load**. New products may also be created (see **Product Actions** below).

### Editors

**Station.** This editor pushbutton displays the Station List for review and edit.

<b>Product Actions</b>	<p><b>New/Add.</b> Create a new product by typing the product ID in this field and pressing <b>Add</b>.</p> <p><b>Verify.</b> After you have created a new product, select <b>Verify</b> to check that the required files exist for the product.</p> <p><b>Save.</b> This selection saves all the setup and product data from the GUI.</p> <p><b>Delete.</b> You may delete a product by selecting the product ID from the scrolled list and hitting <b>Delete</b>.</p> <p><b>Help.</b> This selection displays general information about the various sections in the GUI.</p> <p><b>Close.</b> Closes the GUI.</p>
<b>Addressee</b>	This is a three-letter identifier for the product routing address.
<b>Window for Marine Obs(hours):</b>	By default, if observations are more than 1 hour old, they are considered invalid and are not used in the roundup. However, since C-MAN, buoy, and ship observations are not necessarily reported every hour, an option to use older observations is included in the GUI. Marine observations, up to the number of hours entered in this window, will be considered valid and used by the HWR NWS application.
<b>Include temperature in deg C?:</b>	This option is used to output the temperature, in degrees Celsius, in the Remarks field. However, just because this field is selected it does not mean the temperature in degrees Celsius will always be output. The Remarks section can contain a maximum of two weather elements based on a fixed priority order, with the temperature in degrees Celsius having the lowest priority.
<b>Express sky conditions when SCP missing?:</b>	ASOS METAR cloud observations do not exceed 12,000 feet, so the sky/weather phrase may not be generated accurately when there is no significant weather and the ASOS cloud observation is not cloudy. Satellite cloud observations are used to supplement ASOS observations in these conditions. If this option is selected, and the SCP is missing while the ASOS observation is clear or partly cloudy, the phrase "FAIR" will display. Otherwise, when the SCP is missing, the sky/weather will be output as missing.
<b>Time Zone:</b>	The forecaster can specify the time zone to be used in the product via this option.
<b>Std time all year?:</b>	This Standard Time All Year option must be selected for those areas that do not switch to Daylight Savings Time.

**Thresholds**

**Heat Index.** The forecaster can specify the minimum heat index value at or above which a heat index phrase is to be output.

**Wind Chill Index.** For the wind chill index to be calculated, the observed temperature must be at or below the value entered in **Max Temp(deg F)** and the observed wind speed must be at or above the value entered in **Min Wind Speed(mph)**. Also, the calculated wind chill index must be at or below the value entered in **Max WCI** for a wind chill index to be output.

**Marine Fields**

To determine the HWR NWWS data line length, select either **69** or **80**, which represent the number of characters to be formatted per line, and choose the marine fields to be included in the HWR NWWS product (from **Field selection**). The **Station ID** field is automatically selected; the field is necessary for this product. You may select from one up to all of the rest of the fields provided in the GUI. The GUI provides a running total, named **Field size**, of the number of characters comprising the marine fields you selected, which includes the blank spaces that will be inserted between each marine field. When the **Field size** exceeds the **Line length**, the resulting output product will contain marine fields that are wrapped on to a second line for stations reporting those fields.

### 9.3.3.3 *Creating a Station List*

The Station Format Editor is used to create the Station List. An example of an HWR NWWS Station List is shown in Exhibit 9.3.3.3-1.

The software delivery includes a template (product ID CCCSWRXX) that you may cut, paste, and edit to match your requirements. The station list begins with the AFOS PIL, WMO Header, and the Mass Media Header followed by comment lines. The comment lines are followed by universal generic code with expiration date/time. Another comment follows to identify the part(s) of the state in which the succeeding group of stations, called a segment, are located. Next, the stations in the group are listed.

**Comment Lines**

Any line in the Station List that begins with a tilde “~” is interpreted as information which will appear verbatim in the HWR NWWS output product. Symbolic words, converted into data observations (refer to Exhibit 9.3.3.3-2), can be inserted into these comment lines. Any line starting with the pound symbol (#) is interpreted as being an internal Station List comment and is not included in the HWR NWWS output product.

```

# Product 1
~Missouri State Weather Roundup... Test product
~National Weather Service Central Region HQ
~%HEADDT%
~
~Note: "fair" indicates few or no clouds below 12,000 feet with no
~significant weather and/or obstructions to visibility.
~
~!MOZ005>007-011>016-020-021-028-029-037-043-%DDHMM%
~...West Central and Northwest Missouri...
!!!!FF_STATIONS
/KMCI//+KC INTL APT
/KMKC/KMCI/+KC DOWNTOWN
/KSTJ//+ST JOSEPH
~$$
~
#
~!MOZ079>081-088-090>094-101-102-%DDHMM%
~...Southwest Missouri...
!!!!FF_STATIONS
/KSGF// -SPRINGFIELD
/KJLN// -JOPLIN
~$$
~
#
~!MOZ038>042-044>050-056>058-069>072-082-083-%DDHMM%
~...East Coast...
!!!!MAR_STATIONS
/MISM1// -MATINICUS ISLE
/MDRM1// +MT DESERT ROCK
/SAUF1// -ST. AUGUSTINE
~$$
~
~!MOZ008>010-017-018-061-063>065-%DDHMM%
~...West Coast...
!!!!MAR_STATIONS
/POTA2// -POTATO POINT
/FFIA2// +FIVE FINGER LH
/BLIA2// +%LATLON%
/TTIW1// +TATOOSH ISLAND
~$$
~
#

```

**Exhibit 9.3.3.3-1. Sample Station List for the NWWS**

```

%DATE% - the current date (e.g., August 6).
%DAY% - the current day of the week (e.g., Thursday).
%TIME% - the current hour (e.g., 9 AM).
%TIMEZ% - the current nominal hour and time zone (e.g., 9AM Pacific
Daylight Time).
%TIMEW% - the product creation time in numerical format (e.g., 251908, which
means 25th day of the month, 19th hour, 8th min).
%HEADDT%- the NWWS header date/time (e.g., 900 AM PACIFIC DAYLIGHT TIME THURSDAY
AUGUST 6, 1998).
%DDHMM%- the current date of the month, nominal hour, and minute of the
observation (e.g., 251900, which means 25th day of the month, 19th hour, 0th min).

```

**Exhibit 9.3.3.3-2. Symbolic Words**

### Fixed Phrase Stations

Enter **!!!!FF\_STATIONS** to identify that fixed phrase land stations follow in the station list. Fixed phrase land stations are identified by their four-character ICAO identifiers (e.g., KCRW) and are listed in the order they are to be output, one station per line.

Place a slash “/” on each side of the surface station (METAR or marine observation) identifier.

Next, place another four-character ICAO identifier for the representative SCP station followed by a slash, unless the station identifier is identical to the surface station identifier. In such cases, it is not necessary to repeat the surface station identifier. Instead, place another slash after the previous one.

Next, place the missing station flag which is either the plus sign “+,” minus sign “-,” the equal sign “=,” or the ampersand “&.”

The “+” indicates that the corresponding station will always be output, even if the weather elements are missing (i.e., “NOT AVBL”).

The “-” indicates that the station will be ignored if all the weather elements for the station are missing.

The “=” indicates that the corresponding land station will always be output, even if all weather elements are missing. This symbol also indicates that additive data are to be appended immediately below the station’s hourly data.

The “&” indicates that the corresponding land station will be dropped if all weather elements are missing. This symbol also indicates that additive data are to be appended immediately below the station’s hourly data.

Enter the fixed phrase station name after the missing station flag. As many as 14 characters may be used for land station names. Sample fixed phrase station lines follow:

```
/KCGI//=CAPE GIRARDEAU
/KMKC/KMCI/-KC DOWNTOWN
WS/ -tbw4
/tmp
```

Land stations are grouped together in segments consisting of up to 10 stations. Each segment ends with **~\$\$** as shown in the following example.

```
!!!!FF_STATIONS
/KMCI//+KC INTL APT
/KMKC/KMCI//+KC DOWNTOWN
/KGVW//+GRANDVIEW
/KSTJ//+ST JOSEPH
/KP35//+SPCKARD
~$$
#
~!MOZ079>081-088-090>094-101-102%DDHHMM%
~...Southwest Missouri...
11111FF_STATIONS
/KSGF// -SPRINGFIELD
```

```
/KJLN//~JOPLIN
~$$
```

### Marine Observations

Enter **!!!!MAR\_STATIONS** to identify that marine stations follow in the station list. Marine stations are identified by their alphanumeric identifier (e.g., WECB, MISM1, 41002). They are listed in the order they are to be output, one station per line.

Place one slash “/” before the identifier and two slashes after it.

After the second slash, place either the plus sign “+” or minus sign “-” missing station flags as described under the Fixed Phrase Stations. Enter the marine station name after the missing station flag. As many as 18 characters may be used for the station name.

Use the keyword **LATLON** surrounded by percent signs (%) in place of the marine station name to output the station latitude and longitude instead of its name.

Marine stations are grouped together in segments of up to 10 stations. Each segment ends with **~\$\$** as shown in the following example.

```
~!MOZ038>042-044>050-056>058-069>072-082-083-%DDHHMM%
~...East Coast...
!!!!MAR_STATIONS
/MISM1//~MATINICUS ISLE
/MDRM1//+MT DESERT ROCK
/SAUF1//~ST. AUGUSTINE
~$$
~!MOZ008>010-017-018-061-063>065-%DDHHMM%
~...West Coast...
!!!!MAR_STATIONS
/POTA2//~POTATO POINT
/FFIA2//+FIVE FINGER LH
/BLIA2//+%LATLON%
/TTIW1//+TATOOSH ISLAND
/41002//+%LATLON%
~$$
```

#### 9.3.3.4 Updating Station PILs

##### Hourly Weather Roundup PILs Editor

The **Hourly Weather Roundup PILs Editor** is the interface that reads the **/awips/adapt/hwr/etc/pil.data** file and creates a listing of NWR and NWWS stations where each station mapped to their respective AFOS site ID and SCD ID.

The **/awips/adapt/hwr/etc/pil.data** configuration file contains a list of AWIPS station IDs, AFOS METAR IDs, and SCD IDs derived from the **\$FXA\_HOME/data/localization/nationalData/afosMasterPIL.txt** configuration file. It is used to allow data retrieval from the text database by providing the full AFOS IDs for METAR and SCD reports for each AWIPS site ID listed. The values in the first column are AWIPS site IDs. The values in the second column are AFOS METAR IDs. The

values in the third column are SCD site IDs. If no AFOS or SCD site ID is available, the value of 'XXXXXXXXXX' may be added its respective columns.

The **pil.data** file should be updated every time a new product is added or a station is added or deleted from a product. Also, the **pil.data** file should only be updated through the **HWR PILs Editor** GUI. Saving changes writes to the **/awips/adapt/hwr/etc/pil.data** file. The **afosMasterPIL.txt** file is not affected.

To access the HWR PILs Editor from the System Control Menu, select **Background WFO Apps, Hourly Weather Roundup (HWR)** from the cascading menu. This will display the **Hourly Weather Roundup** GUI shown in Exhibit 9.3.3.2-1.

- Select:**           **PILs** pushbutton
- The PILs Editor shown in Exhibit 9.3.3.4-1 will appear.

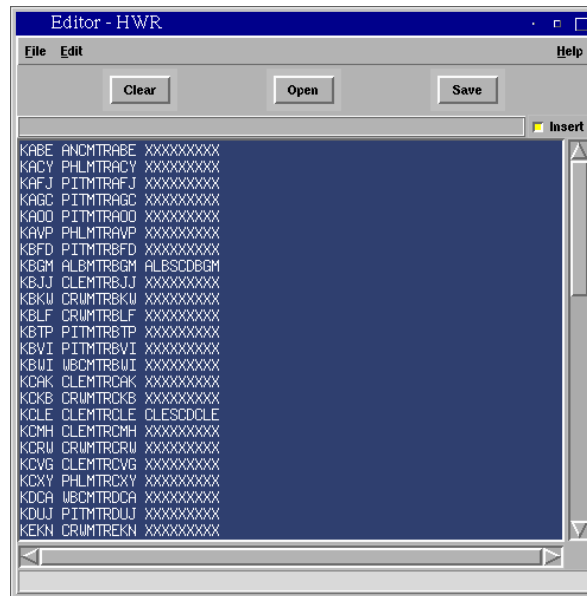

**Exhibit 9.3.3.4-1. PILs Editor**

Once the PILs Editor has opened, you have the following options:

## Menu Options

### *File*

- Print:** Invokes the print dialog.
- Update:** Updates AFOS site IDs for all NWR and NWWS products based on the **\$FXA\_HOME/data/localization/nationalData/afosMasterPIL.txt** file. Update will search the **afosMasterPIL.txt** file for CCCMTRXXX and CCCSCDXXX entries where XXX is the AWIPS site ID. If a match is not found, the AFOS site ID is displayed as XXXXXXXXXXXX (and the retrieval of METAR/SCD report is not attempted). If a station entry is listed in the text widget, the METAR and SCD IDs are not updated.

**Replace:** Replaces the entire list based on the `/data/fxa/nationalData/afosMasterPIL.txt` file. All entries listed in the text widget are replaced.

**Close:** Exits from the PILs Editor GUI.

### *Edit*

**Cut:** Removes highlighted text from the widget and saves to a buffer.

**Copy:** Makes a copy of highlighted text from the widget to a buffer.

**Paste:** Copies text from the buffer to the widget.

**Find:** Search and replace utility for finding text within the widget list.

### **Button Options**

**Clear** Clears all text from the widget.

**Open** Loads PILs data from `/awips/adapt/hwr/etc/pil.data` file.

**Save** Saves content of the text window to the `/awips/adapt/hwr/etc/pil.data` file.

**Insert** Toggles on and off text insert mode.

#### **9.3.3.5 Treatment of Missing Data**

The HWR NWWS application treats missing data as described below.

If the entire observation for the station is missing and the station is marked with a “+” or “=” symbol in the station list, the station is output as “NOT AVBL.”

If the entire report for a station is missing and the station is marked with a “-” or “&” symbol in the station list, the station is not output.

If wind speed is missing, “MISG” is output in the wind field. If sky/weather, temperature in degrees Fahrenheit, dew point, relative humidity, or pressure is missing, “N/A” is output in the respective field. Up to two weather elements may be output as remarks in a fixed priority order. Thus, if one element is missing, the weather element with the next highest priority is output. If only one of the remark field’s weather elements is available, only that element will be output. If none of the remark’s section weather elements are available, this field is left blank. If none of the 6-hour, additive data, weather elements are available, these fields will be skipped.

Low-level, cloud cover observations are supplemented with satellite-derived middle and upper-level cloud cover observations which result in the handling of missing data as follows:

- If the ASOS cloud cover observation is missing, but the SCP product, which contains information on only middle and high level cloud cover is available, the cloud cover is considered missing.



- If the ASOS observation shows overcast conditions, the SCP product is not needed, since the sky conditions will be reported as cloudy.
- If the ASOS observation shows broken clouds, the SCP product will be accessed to determine if the sky is overcast. If the SCP product is missing, the sky conditions will be reported as **PARTLY SUNNY** or **MOSTLY CLOUDY**, depending on the time of day.

#### 9.4 *Hourly Weather Roundup Formatter for the NOAA Weather Radio*

The HWR is a summary of the current weather observations for locations in and around the local area including marine observations for those WFOs with coastal responsibilities.

The HWR NWR formatter application prepares voice-ready products for NWR broadcast. The products are automatically sent to the NWR across the AWIPS LAN to the CRS LAN or via a computer-to-computer link to a site-provided PC running Bubble and Airwave, which will transfer the products to the CRS, but the forecaster is given the opportunity to review and edit them.

The Hourly Weather Roundup uses

- METAR observations
- Marine observations
- SCD
- SCP.

The HWR NWR application (**hwrnwr**) uses METAR and marine observations, the SCP, and SCD to perform required calculations; build phrases; and add instructions for the CRS. The output product is stored temporarily and the WFO is notified of its completion.

**NOTE:** The forecaster-entered **METARINT** value in the **nwr.config** file specifies the number of minutes before the hour at which to start including the METAR observations in the HWR. The HWR considers any observations from H-METARINT up to but not including H+(60-METARINT) as an observation for the nominal hour. For example, if the METARINT value is 15, observations at 0845Z are considered 0900Z observations but observations at 0840Z are considered 0800Z observations. So, if an observation comes in at H+0:40, HWR will consider that observation to be from last hour and reject it.

At this point, the forecaster uses the NWR Browser to:

- View the list of products that are available for viewing and editing but have not yet been sent to the CRS.
- View the list of products that have been sent to the CRS.

- Select a product from the **Delayed** or **Sent lists** and **View** (not edit) in a separate window.
- Select a product from the **Delayed** or **Sent lists** and **Edit** the product in the **NWR** editor.
- Send the selected product to the CRS.
- Refresh the **Delayed** and **Sent** lists.
- Display a list of log files. When the **Log File** list is displayed, the **View Logs** button becomes a **Refresh Log Window** button.

### 9.4.1 Configuration Files and Environment Variables

#### Environment Variables

The following environment variables are referenced in this chapter for user **fxa** and individual user accounts and their full paths are provided below.

```
$LOG_DIR           /data/logs/fxa
$FXA_HOME          /awips/fxa
$FXA_DATA          /data/fxa
```

#### Configuration Files

##### **nwr.config**

The **nwr.config** configuration file contains:

- The list of products to be produced for the NWR
- The paths to the **NWRBrowser**, **transferNWR** script, and destination directory
- The allotted forecaster review period before the product is sent to the CRS
- The number of minutes before the hour at which to start including METAR observations in the HWR.

The file resides in the **/awips/adapt/hwr/etc/nwr** directory. An example of a **nwr.config** file follows.

```
# nwr.config
# configuration file for hwrnwr
#
GUI      /awips/fxa/bin/NWRBrowser
SCRIPT  /awips/fxa/bin/transferNWR -a
DESTDIR /data/fxa/workFiles/nwr/pending
REVIEW  7
METARINT 15 # minutes before the hour at which to
start using METARs in HWR
#
TEMP_PHRASE 0 # 1 = Descriptive phrasing; 0 =
Specific numbers
# Flags associated with PRODUCT ID below should only
rarely be changed. # See users' manual
```

```
# Product list. The following products will be
generated:
PRODUCT  HFOHWRNW1      AD_    0
PRODUCT  HFOHWRNW2      AD_    1
PRODUCT  HFOHWRNW3      AD_    0
~
```

**nwr.cfg**

The **nwr.cfg** file is a dedicated configuration file that holds the username, a line of dummy text as a placeholder (this will be the NWR CRS password until CRS Build 10 is released) and the password for Telnet and FTP and the connectivity type (PC or LAN). The information must be kept exactly in the previously mentioned order. The file resides in the **\$FXA\_DATA/workFiles/nwr** directory.

**9.4.2 Processes**

```
PX1    hwrnwr
LX     hwrgui
LX     hmMonitor.tcl
LX     hmMonitorWish
PX1    hmMonitorServer
LX     NWRBrowser
LX     transferNWR
PX1    nwrTrans.pl
PX1    sendToNWR
```

Refer to Exhibit 9.4.2-1 for the HWR Formatter for NWR data flow diagram.

**hwrnwr**

The **hwrnwr** process requires the following input:

- Decoded marine observations from netCDF files
- Decoded METAR observations from the text database (fxatext)
- SCD and SCP data from the text database (fxatext)
- Setup data, which includes the station lists, broadcast records, and defaults records from the **CCCHWRXXX.setup** and **CCCHWRXXX.product** files
- Configuration information and threshold selections from the **nwr.config** file.

The **hwrnwr** process performs required calculations on land and marine hourly weather data and surface and satellite, builds phrases, and adds instructions for the CRS. The output product is stored temporarily and the forecaster is notified of its completion. The forecaster may change the text product using the **NWRBrowser** before the product is sent to the CRS. The product must be sent to the CRS using a pushbutton (**NWREditor**) on the browser which invokes the **transferNWR** script. If the forecaster does not view, edit, and send the product manually to the CRS via the browser, **hwrnwr** will, after a forecaster-specified period of time, send the product automatically to the CRS.

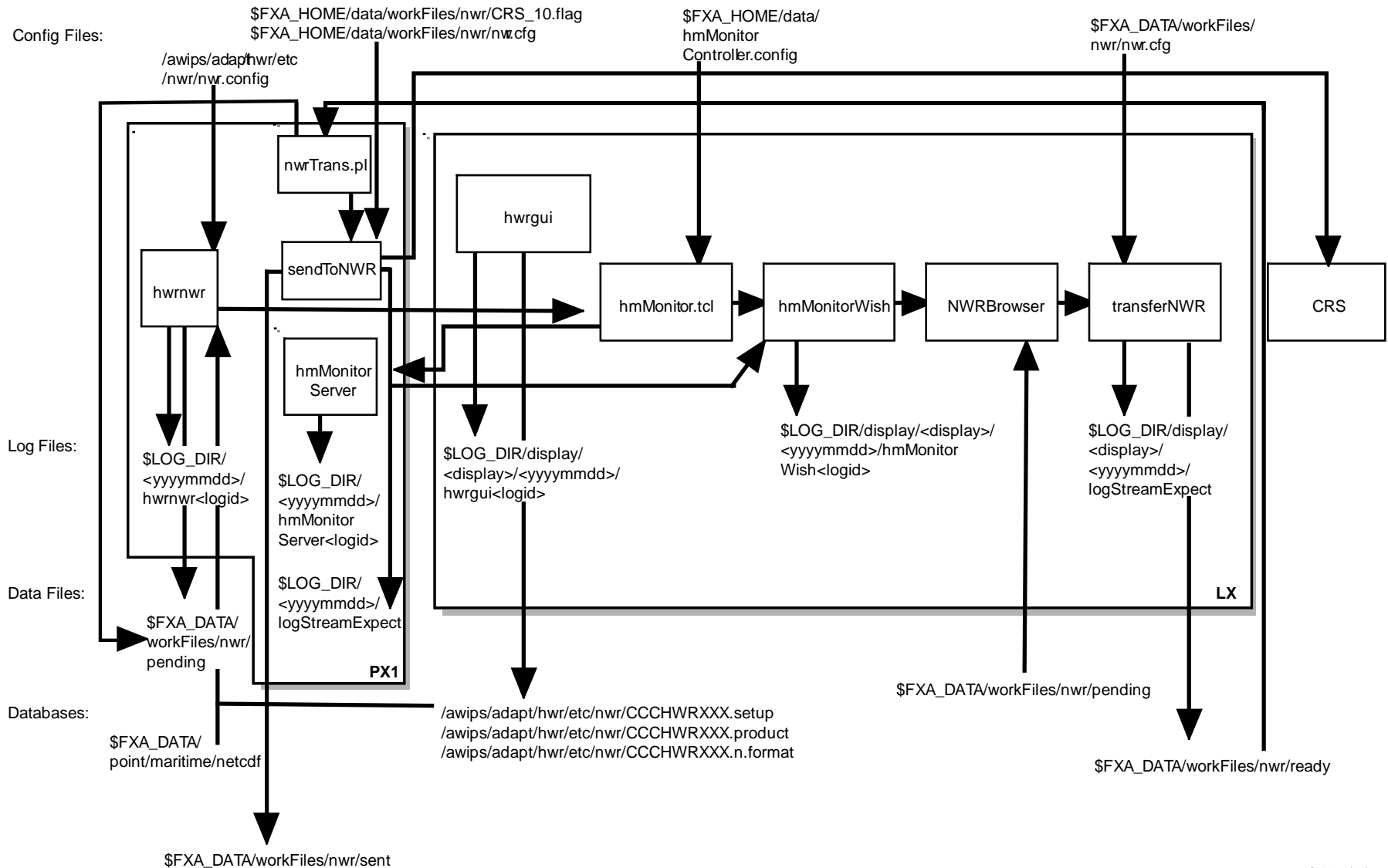

SMM 07/19/10

**Exhibit 9.4.2-1. Hourly Weather Roundup Formatter for NOAA Weather Radio**

- ▶ **To View the Current Day's hwrnwr Log**  
**On PX1 as user fxa or your individual user account,**

**TYPE:** `cd $LOG_DIR/<yyyymmdd>`  
 ▪ Where `<yyyymmdd>` is today's date.

**TYPE:** `ls -ltr hwrnwr*`  
 ▪ Displays the current day's **hwrnwr** logs from earliest to latest.

**TYPE:** `tail -f <logname>`  
 ▪ Displays the log as it updates with the latest messages.

### Log Message Format

An entry in the log should look like the following:

```
LOG-STATUS: Log file opened on host px1-tbw4 at Wed May 12 04:10:38 2006
04:10:37.770 C_hmHMU_logError.C PROBLEM:
WARNING message from function/subroutine "get_METARs":No reports were retrieved by
get_report.
```

```
04:10:45.578 C_hmHMU_logError.C PROBLEM:
WARNING message from function/subroutine "get_METARs":
No reports were retrieved by get_report.
```

The log consists of the following fields:

Time stamp	04:10:45.578
File name	C_hmHMU_logError.C
Message type	PROBLEM:
Message string	WARNING message from function/subroutine "get_METARs": No reports were retrieved by get_report.

### hwrgui

For **hwrnwr** to require/allow configuration and threshold information from the forecaster, it enables the forecaster to make selections using the GUI controlled by processes launched by the **hwrgui** process. The forecaster selections are validated and stored in the **CCCHWRXXX.setup** file.

The **hwrgui** process uses the station format editor to create the station list for each output product. Each list contains the METAR and SCD station identifier, the SCP station identifier, a symbol to indicate how to treat missing data, and the station name. The product IDs and the station lists are stored in the **CCCHWRXXX.product** file. The **hwrgui** process stores the broadcast and default broadcast records in the **CCCHWRXXX.n.format** table.

► **To View the Current Day's hwrGui Log**

On the workstation, as user fxa or your individual user account,

- TYPE:** `cd $LOG_DIR/display/<display>/<yyyymmdd>`
- Where **<display>** is the current display variable (e.g., lx1-tbw4:0) and **<yyyymmdd>** is today's date.
- TYPE:** `ls -ltr hwrGui*`
- Displays the current day's **hwrGui** logs from earliest to latest.
- TYPE:** `tail -f <logname>`
- Displays the log as it updates with the latest messages.

### Log Message Format

An entry in the log should look like the following:

```
hwrGui 3611 975425655.214865 15:34:15.214 PROBLEM:
WARNING message from function/subroutine "get_METARS":
No reports were retrieved by get_report.
hwrnwr 3611 975425659.125953 15:34:19.125 PROBLEM:
WARNING message from function/subroutine "get_METARS":
No reports were retrieved by get_report.
```

The log consists of the following fields:

Time stamp	15:34:19.125
Module name	hwrnwr
Message type	PROBLEM:
Message string	WARNING message from function/subroutine "get_METARS": No reports were retrieved by get_report

### hmMonitor.tcl

The Monitoring Controller process is the GUI by which a user is alerted to the receipt of a notification message sent by the **hmMonitorServer**. The **hmMonitor.tcl** script executes **hmMonitorWish** to create the **hmMonitor** GUI. The product ready notification is passed to the GUI by the **hmMonitorServer**. When the **HWR** button is pressed in the **Monitoring Controller GUI**, the CRS editor containing the HWR message is started and a message is sent to the Monitoring Controller to delete the notification message from other monitoring controllers. The **hmMonitor** GUI notifies the **hmMonitorServer** when new notifications arrive.

### Restart Monitor Controller Window

The Monitoring Controller Window displayed on the text workstation is used to monitor HWR and Climate applications. If this window is closed, it can be restarted by executing the following command on the workstation as user **fxa** or your individual user account:

**TYPE:** `setenv DISPLAY xt<#>--<siteID>:0.0`

- Where <#> is the text workstation number and <siteID> is the site ID (e.g., xt2-hgx).

**TYPE:** `./awips/fxa/bin/hmMonitor.tcl`

### hmMonitorWish

The **hmMonitorWish** process is the main process for the **Monitoring Controller GUI** and also is responsible for all necessary initializations.

#### ► To View the Current Day's hmMonitorWish Log

On the workstation, as user fxa or your individual user account,

**TYPE:** `cd $LOG_DIR/display/<display>/<yyyymmdd>`

- Where <display> is the current display variable (e.g., lx1-mrx:0) and <yyyymmdd> is today's date.

**TYPE:** `ls -ltr hmMonitorWish*`

- Displays the current day's **hmMonitorWish** logs from earliest to latest.

**TYPE:** `tail -f <logname>`

- Displays the log as it updates with the latest messages.

### Log Message Format

An entry in the log should look like the following:

```
hmMonitorWish 10489 978998717.685357 00:05:17.685 PROBLEM:
ERROR, severity level MINOR,
in function/subroutine "hmPED_StnId":

Invalid/Missing Station ID
SPECI.
hmMonitorWish 10489 978998717.688864 00:05:17.688 PROBLEM:
ERROR, severity level MINOR,
in function/subroutine "hmPED_StnId":

Invalid/Missing Station ID
METAR.

hmMonitorWish 10489 979035320.151528 10:15:20.151 BUG: Call to UpdateTextWindow
failed:can't read "w": no such variable
LOG-STATUS: Recent traceback from same location in file suppressed.

hmMonitorWish 10489 979035409.064146 10:16:49.064 PROBLEM: Unable to retrieve METARS
for Wed 12 May 2006 10:16 UTC
hmMonitorWish 10489 979037923.611689 10:58:43.611 BUG: Call to UpdateTextWindow
failed:can't read "w": no such variable
LOG-STATUS: Recent traceback from same location in file suppressed.
hmMonitorWish 10489 979037926.356198 10:58:46.356 PROBLEM: Unable to retrieve METARS
for @kM-`
```

```
hmMonitorWish 10489 979041527.857008 11:58:47.857 PROBLEM: Unable to retrieve METARS
for Wed 12 May 2006 06:58 EST
hmMonitorWish 10489 979048744.818430 13:59:04.818 PROBLEM:
ERROR, severity level MINOR,
in function/subroutine "hmPED_StnId":
```

The log consists of the following fields:

```
Time stamp          01:01:52.600
Module name         hmMonitorWish
Message type        BUG:
Message string      Call to UpdateTextWindow failed:  can't read
                    "w":  no such variable
```

## hmMonitorServer

The Monitoring Controller process is the GUI by which a forecaster is alerted to the receipt of a notification message sent by the **hmMonitorServer**.

If the value of **reviewPeriod** in the `/awips/adapt/hwr/etc/nwr/nwr.config` configuration file is defined as greater than zero, **hwrnwr** sends a message to **hmMonitorServer**, which in turn notifies **hmMonitor GUI**. When the forecaster is notified and selects the **HWR** button, the NWR browser will appear. The product may be viewed, edited, and transmitted as the user wishes.

Under normal operations, **hmMonitorServer** starts as part of the site startup process. If it dies, the Climate program will notify users, and it can be restarted manually.

### ► To Restart the hmMonitorServer Process

On PX1, as user fxa,

```
TYPE:          cd /awips/fxa/bin
```

- Changes to the directory where the **hmMonitorServer** resides.

```
TYPE:          hmMonitorServer &
```

- Starts the **hmMonitorServer** as a background process.

To verify the process is running:

```
TYPE:          ps -ef | grep hmMon
```

- Displays the **hmMonitorServer** process, as shown in the following example:

```
fxa 29894      1  1  May  7  ?           24:42 /awips/fxa/bin/hmMonitorServer
```

**NOTE:** Unless the **hmMonitorServer** process is started on PX1 by user **fxa**, there will be no communications with the clients.

If the **hmMonitorServer** shuts down, the server maintains a list of its current clients in the file **hmMonitorServerClientList.txt** located in



**\$FXA\_DATA/workFiles.** When the server is restarted, it rereads this file to re-register any previous clients. If those clients are still running, they will continue to receive notifications once the **hmMonitorServer** process has restarted. If those clients are no longer running, they will be removed from the client list once the first attempt to send a message to that client fails.

► **To View the Current Day's hmMonitorServer Log**

On PX1 as user fxa or your individual user account,

**TYPE:** `cd $LOG_DIR/<yyyymmdd>`  
 ▪ Where **<yyyymmdd>** is today's date.

**TYPE:** `ls -ltr hmMonitorServer*`  
 ▪ Displays the current day's **hmMonitorServer** logs from earliest to latest.

**TYPE:** `tail -f <logname>`  
 ▪ Displays the log as it updates with the latest messages.

### Log Message Format

An entry in the log should look like the following:

```
16:04:19.919 METAR_TextProduct.C PROBLEM: METAR decoding error on product PITMIRLBE
16:04:19.920 HmMonitorTextNotifReceiver.C EVENT: METAR product PITMIRLBE FAILED
decoding!
16:08:05.094 DataSocket.C DEBUG: Connection to lx1-tbw4/3037/18692 has been closed by
the peer.
16:08:05.142 DataSocket.C DEBUG: Closing the socket to lx1-tbw4/3037/18692
16:11:56.534 HmMonitorServer.C EVENT: Registering client px1-tbw4/4635/25150
16:11:56.586 HmMonitorServer.C EVENT: Saving client state...
16:11:56.643 HmMonitorServer.C EVENT: Received client notification message from
px1-tbw4/4635/25150
16:11:56.648 ParameterizedMsg.C EVENT: Send of IPC message failed; Target not
available.
Target: lx1-tbw4/3037/18692
Module: 26
Type: 0
16:11:56.668 HmMonitorServer.C EVENT: Try again later -- unable to send update
notification to client lx1-tbw4/3037/18692
```

The log consists of the following fields:

Time stamp	16:08:05:142
File name	DataSocket.C
Message type	DEBUG:
Message string	Closing the socket to lx1-tbw4/3037/18692

### NWRBrowser

The **NWRBrowser** is a GUI with a threefold purpose:

1. It allows the forecaster to remotely control the NWR from an AWIPS workstation.
2. It allows the forecaster to monitor product transfer from AWIPS to the NWR.
3. It provides last-minute edit capability for products that are to be sent to the NWR from AWIPS.

The **sendToNWR** Expectscript transmits voice-ready text from AWIPS to the NWR. In addition to transferring the product, copies can be kept in one of two directories:

**\$FXA\_DATA/workFiles/nwr/pending**

**\$FXA\_DATA/workFiles/nwr/sent**

When **sendToNWR** is invoked, the product is automatically copied to the **pending** directory. If successfully sent, the product is moved to the **sent** directory. The contents of each directory can be viewed in the window pane dedicated to that directory. Products not successfully transmitted will remain in the **pending** directory.

### **transferNWR**

The **transferNWR** script is responsible for transferring voice-ready products to a holding area where they will be picked up and sent to NWR. The **transferNWR** script is a command-line interface that provides the forecaster with three options:

**transferNWR -a [filename]** This option will automatically transfer the file from the source directory to the **/data/fxa/workFiles/nwr/ready** directory. The full pathname of the file must be given so that the file can first be copied into the source directory. The **transferNWR** script then monitors the **\$FXA\_DATA/workFiles/nwr/pending** directory to verify that the product has been successfully sent to CRS by the **sendToNWR** script.

**transferNWR -d [filename]** This option will also ensure that the file is copied into the source directory, but the file will not be transferred. This option is for cases where the forecaster would first like to inspect or edit the product before it is sent.

**transferNWR -n** This option sends a warning message to the local workstation that there has been a problem in transmitting the file. This message is sent at the forecaster's discretion, based upon the return and exit values issued by this script.

The **transferNWR** script is forked by a parent process, **NWRBrowser**. The **transferNWR** script returns one of the following two values to the parent process:

**Value = 0 indicates all was successful**

**Value = 1 indicates that the transfer may have failed**

Log files can be viewed from the **NWRBrowser**. The most current log is listed last. Logs can also be viewed by other text editors, such as the **vi** editor.

► **To View the Current Day's transferNWR Log**

On the workstation, as user **fxa** or your individual user account,

**TYPE:** `cd $LOG_DIR/display/<display>/<yyyymmdd>`  
 ▪ Where **<yyyymmdd>** is today's date and **<display>** is the current display variable (e.g., **lx1-mrx:0**).

**TYPE:** `ls -ltr logStreamExpect*`  
 ▪ Displays the current day's **transferNWR** logs from earliest to latest.

**TYPE:** `tail -f <logname>`  
 ▪ Displays the log as it updates with the latest messages **Log Message Format**.

An entry in the log should look like the following:

```
LOG-STATUS: Log file opened on host px1-tbw4 at Wed May 12 18:19:05 2006
18:19:05.358 TclLogStream.C EVENT: File /data/fxa/workFiles/nwr/pending/PITHWRNW1
will be automatically transferred
18:19:05.359 TclLogStream.C EVENT: /data/fxa/workFiles/nwr/pending/PITHWRNW1 has been
copied to data/fxa/workFiles/nwr/ready/PITHWRNW1 for processing by sendToNWR.
```

**NOTE:** Check the **logStreamExpect** log on PX for information about transfer of **data/fxa/workFiles/nwr/pending/PITHWRNW1** to CRS.

The log consists of the following fields:

Time stamp	18:19:05.358
File name	TclLogStream.C
Message type	EVENT:
Message string	File /data/fxa/workFiles/nwr/pending/PITHWRNW1 will be automatically transferred

### **nwrTrans.pl**

The **nwrTrans.pl** Perl script is a persistent script that looks in **/data/fxa/workFiles/nwr/ready** every couple of seconds to find files that have been placed there by either the **NWRBrowser** or **nwrEditor** GUIs when a user requests to send a product to the CRS for broadcast on the NOAA Weather Radio. This script then calls **transferNWR** for any files that were found. Previously, **transferNWR** was called directly from the **NWRBrowser** or **nwrEditorWish**. **transferNWR** is always run as user **fxa** to ease maintenance of the NWR CRS's authorized keys file on the CRS. This change was required by the move to secure shell (**ssh**) and individual user accounts.

## sendToNWR

The **sendToNWR** Expect script transmits voice-ready text is transmitted from AWIPS to the NWR. In addition, copies of the product can be kept in one of two directories:

**\$FXA\_DATA/workFiles/nwr/pending**

**\$FXA\_DATA/workFiles/nwr/sent**

The **sendToNWR** script is called from the **nwrTrans.pl** script, which is a persistent **fxa** process that checks the **/data/fxa/workFiles/nwr/ready** directory every 2 seconds for products placed there by the **transferNWR** script. When **nwrTrans.pl** finds a file, or files, in this directory, it calls **sendToNWR** for each file.

The **sendToNWR** script is responsible for transferring voice-ready products from AWIPS to the NWR. The **sendToNWR** script is a command-line interface that provides the forecaster with three options:

- |                                |                                                                                                                                                                                                                                          |
|--------------------------------|------------------------------------------------------------------------------------------------------------------------------------------------------------------------------------------------------------------------------------------|
| <b>sendToNWR -a [filename]</b> | This option will automatically transfer the file from the source directory on AWIPS to the destination directory on the CRS. The full pathname of the file must be given so that the file can first be copied into the source directory. |
| <b>sendToNWR -d [filename]</b> | This option will also ensure that the file is copied into the source directory, but the file will not be transferred. This option is for cases where the forecaster would first like to inspect or edit the product before it is sent.   |
| <b>sendToNWR -n</b>            | This option sends a warning message to the local workstation that there has been a problem in transmitting the file. This message is sent at the forecaster's discretion, based upon the return and exit values issued by this script.   |

**NOTE:** The **transferNWR** script also may continue to be used for the **-d** and **-n** options.

When **sendToNWR** is invoked, the product is automatically copied to the **pending** directory. If successfully sent, the product is moved to the **sent** directory. The contents of each directory can be viewed in the windowpane dedicated to that directory. Products not successfully transmitted will remain in the **pending** directory.

### ► To View the Current Day's sendToNWR Log

On PX1, as user **fxa** or your individual user account,

**TYPE:**            **cd \$LOG\_DIR/<yyyymmdd>**  
                       ▪        Where **<yyyymmdd>** is today's date.

- TYPE:** `ls -ltr logStreamExpect`
- Displays the current day's log.
- TYPE:** `tail -f <logname>`
- Displays the log as it updates with the latest messages **Log Message Format**.

An entry in the log should look similar to the following:

```
00:12:10.531 TclLogStream.C EVENT: telnet and ftp will be used to transfer BOSHWRNW2
00:12:10.543 TclLogStream.C EVENT: File /data/fxa/workFiles/nwr/pending/BOSHWRNW2
will be automatically transferred
00:12:10.798 TclLogStream.C EVENT: Successful ping to OMP
00:12:10.994 TclLogStream.C EVENT: Successful ping to 5MP
00:12:42.004 TclLogStream.C EVENT: Master processor is OMP
00:12:42.008 TclLogStream.C EVENT: 7 ss_ms processes running on OMP currently
00:12:42.016 TclLogStream.C EVENT: file BOSHWRNW2 will be transmitted to CRS as
BOSHWRNW2.AW

00:12:46.278 TclLogStream.C EVENT: transfer complete to OMP
00:12:46.396 TclLogStream.C EVENT: Successful transfer of BOSHWRNW2 to OMP
.
.
.
12:13:21.696 TclLogStream.C EVENT: transfer complete to OMP
12:13:21.748 TclLogStream.C EVENT: Successful transfer of BOSHWRNW3 to OMP
12:28:49.517 TclLogStream.C EVENT: File output_am_MRN.nwr will be automatically
transferred
12:28:49.597 TclLogStream.C EVENT: output_am_MRN.nwr has been copied to
/data/fxa/workFiles/nwr/ready/output_am_MRN.nwr for processing by sendToNWR. Check
logStreamExpect log on PX for information about transfer of output_am_MRN.nwr to CRS
12:28:51.559 TclLogStream.C EVENT: telnet and ftp will be used to transfer
output_am_MRN.nwr
12:28:51.570 TclLogStream.C EVENT: File
/data/fxa/workFiles/nwr/pending/output_am_MRN.nwr will be automatically
transferred
12:28:51.789 TclLogStream.C EVENT: Successful ping to OMP
12:28:51.942 TclLogStream.C EVENT: Successful ping to 5MP
12:29:22.502 TclLogStream.C EVENT: Master processor is OMP
12:29:22.504 TclLogStream.C EVENT: 7 ss_ms processes running on OMP currently
12:29:22.545 TclLogStream.C EVENT: file output_am_MRN.nwr will be transmitted to CRS
as output_am_MRNnwr.AW
```

The log consists of the following fields:

Time stamp	00:12:10.543
File name	TclLogStream.C
Message type	EVENT:
Message string	File /data/fxa/workFiles/nwr/pending/BOSHWRNW2 will be automatically transferred

The logs are purged by the **scour** script after 2 days and the empty directories are removed by the **master.purge** script.

### 9.4.3 *Setting Up the HWR NWR Application*

Before it can be used, the HWR NWR application must be set up (localized) for your site. Specify options and thresholds using the HWR NWR Setup Product options:

- Create a Station List
- Create a Broadcast Format
- Create a Default Format
- Update the Station PILs list.

**NOTE:** Setting up the HWR NWR application only needs to be done upon the initial application installation and when creating a new product identifier.

#### 9.4.3.1 *Identifying the Products to be Created*

To identify the products to be produced, press the **NWR** button in the **Product Setup** section of the HWR GUI. Either select an existing product and press **Load**, or create a new product by typing in the **Product Actions** section and press **Add**.

#### 9.4.3.2 *Selecting the HWR NWR GUI Options*

To access the HWR Editor for NWWS from the root or **applauncher** menu, select **Background WFO Apps, Hourly Weather Roundup (HWR)** from the cascading menu. This will display the **Hourly Weather Roundup** GUI shown in Exhibit 9.3.3.2-1.

- Select:** **NWR** pushbutton in the **Product Setup** section.
- The Hourly Weather Roundup Editor for the NOAA Weather Radio shown in Exhibit 9.4.3.2-1 will appear.

Once the editor for NWR has opened, you will see the following setup options:

**Products.** This pushbutton displays the list of products that may be converted to output products. Each product must contain a Station List file (via the Station Editor), at least one Broadcast and one Default Format file. New products may also be created, as discussed in the Products Actions below.

#### **Editors**

**Station** This editor pushbutton displays the Station List for review and edit.

**Broadcast** A Product may have multiple Broadcast Formats. The Broadcast Format files are numbered zero through nine. The numbered pushbutton displays the Broadcast Format file numbers for selection by the forecaster. The Editor pushbutton displays the selected Broadcast Format file for review and edit. Note that Broadcast file zero is the default format, which is accessed whenever one or more of the weather element requested in the associated station file is missing.

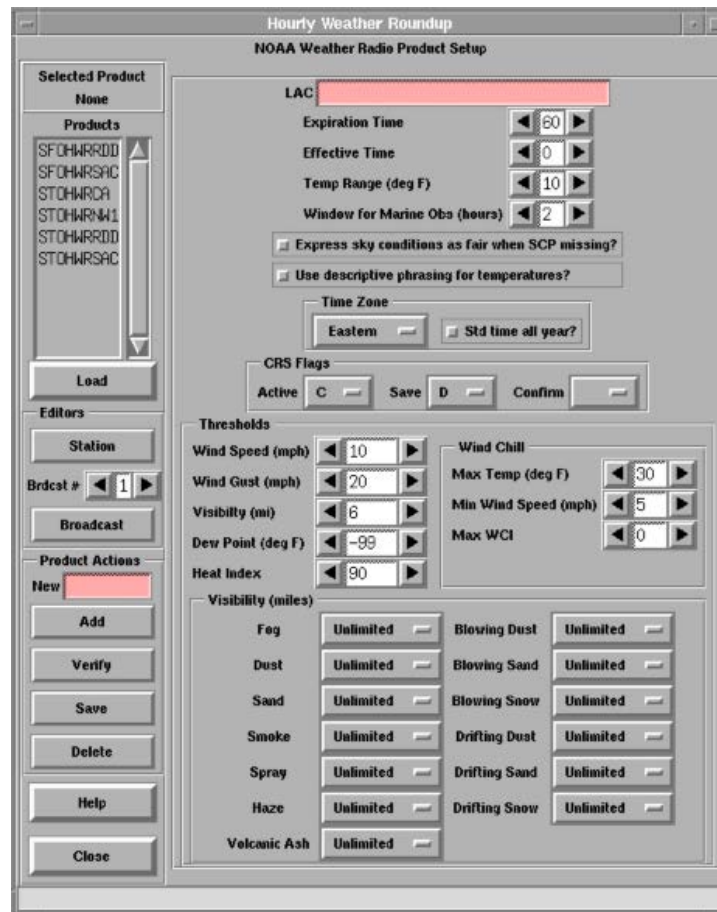

Exhibit 9.4.3.2-1. The Hourly Weather Roundup Editor for the NOAA Weather Radio

### Product Actions

- Add** Create a new product by typing the product ID in this field and pressing **Add**.
- Verify** After you have created a new product, select **Verify** to check that the required files exist for the product.
- Save** This selection saves all the setup and product data from the GUI.
- Delete** You may delete a product by selecting the product ID from the scrolled list and hitting **Delete**.
- Help** This selection displays general information about the various sections in the GUI.
- Close** Closes the GUI.

**LAC.** This is the Listening Area Code (LAC) field. Enter the zones for which the product must be transmitted. The CRS maps these zones to the correct transmitter.

**NOTE:** It is beyond the scope of this document to describe how the CRS maps the LAC text to the correct transmitters.

**Expiration Time.** The number of minutes entered into this field will be added to the nominal hour to determine the expiration time of the product.

**Effective Time.** The number of minutes entered into this field will be added to the nominal hour to determine the effective time of the product.

**Temp Range (deg F).** The number entered into this field determines the range of temperatures at or below that the temperatures for a group of stations in summary format will be summarized.

**Window for Marine Obs (hours).** By default, observations that are more than 1 hour old are considered invalid and are not used by the HWR application when preparing products. However, since many C-MAN, buoy, and ship observations are not reported every hour, you may specify a longer valid period for the Marine Observations. Marine observations, up to the number of hours entered in this window, will be considered valid and used in the product.

**Express sky conditions as fair when SCP missing?** Since ASOS METAR cloud observations do not exceed 12,000 feet, the sky/weather phrase may not be generated accurately when there is no significant weather and the ASOS cloud observation is not cloudy. Satellite cloud observations (the SCP) are used to supplement the ASOS observations under these conditions. If this option is selected, and the SCP is missing while the ASOS observation is clear or partly cloudy, the phrase "FAIR" will be expressed. Otherwise, when the SCP is missing, the sky/weather will be output as missing in the product.

**Use descriptive phrasing for temperatures?** In summary format, you can describe the temperature for a group of stations descriptively (e.g., mid 60's) numerically (63 to 65).

**Time Zone.** Specify the time zone to be used in the product.

**Std Time All Yr?** The Standard time all year option must be selected for those areas that do not switch to Daylight Savings Time.

**CRS Flag.** There are three flags used by the CRS that are user-selectable. The first flag was originally designed to permit the users to send a product to the CRS and either activate (A) its broadcast or store it (I). The C flag is used to indicate that the product is meant for the nearest version of console hardware. The second flag indicates whether the product should be deleted (D) after it expires, or saved (S). The last flag indicates whether the CRS should confirm (C) receipt of the product or not (blank).

**Thresholds.** The following threshold fields are used in conjunction with the Broadcast Format file for each product:

- **Wind Speed.** Specify the minimum wind speed at or above which a wind speed phrase is to be output.
- **Wind Gust.** Specify the minimum wind gust speed at or above which a wind gust phrase is to be output.



- **Visibility(mi).** Specify the maximum visibility at or below which a visibility phrase is to be output.
- **Dew Point.** Specify the maximum dew point at or above which a dew point phrase is to be output.
- **Heat Index.** Specify the minimum heat index value at or above which a heat index phrase is to be output.
- **Wind Chill Index.** For the wind chill index to be calculated, the observed temperature must be at or below the value entered in **Max Temp(deg F)** and the observed wind speed must be at or above the value entered in **Min Wind Speed (mph)**. The calculated wind chill index must be at or below the value entered in **Max WCI** for a wind chill index phrase is to be output.

**Visibility Thresholds.** Click on the selection box next to an obscuration in order to set the visibility threshold value for that obscuration. This results in that obscuration (e.g., fog) being output in the HWR product when the visibility is at or below the selected value. A selection of Unlimited results in the obscuration always being output no matter what the visibility is.

### 9.4.3.3 *Creating a Station List*

The Station List is created using the Station Format Editor. You must create a Station List for each product. The Station List specifies the stations that are included in the product. A station may appear in multiple Station Lists.

► **To Create a Station List**

**Access:** The HWR for NOAA Weather Radio Product Setup

**Select:** A Product

**Select:** The Station Editor button from the Editor's section.

- Displays the default HWR NWR text editor for you to type the Station List for the selected product.

An example of a Station List is shown in Exhibit 9.4.3.3-1.

The contents and format of a Station List are described below. The software delivery contains a template under the CCCHWRXXX product ID that will help you create Station Lists for your site's products.

```

# Product TDLHWRNW1
#Broadcast Format Frequency Section (optional)
!!!!BRDCST_FREQ
100
#
# Fixed Format Station section
!!!!FF_STATIONS
~These are the %TIMEZ% observations for the local area, on
~%DAY%, %DATE%.
/KDCA/KDCA/+Reagan National Airport
/KDAA//Fort Belvoir
/KBWI//*B W I Airport;/KADW/+Andrews Air Force Base
/KDCA//&Reagan National Airport
#
# Summary Format
~Here are some observations outside the metro area.
!!!!WX_CONDS
SW TF TC
!!!!SUM_STATIONS
@Throughout the region,
/KHGR//*Hagerstown; /KNHK/+Patuxent River
/KMRB//+Martinsburg
/KSEBY//+Salisbury
/KNHK//Dover
/KCHO//Charlottesville
/KADW//+Andrews Air Force Base
/KRIC//+Salisbury
#
# Marine Format
~Here are some CMAN reports.
!!!!MAR_STATIONS
/BLIA2//Bligh Reef
/TTIW1//+Tatoosh Island
/MISM1//Matinicus Isle
#
~Here are some buoy reports.
!!!!MAR_STATIONS
/46006//+Buoy 46006
/44014//Buoy 44014
/42019//Buoy 42019

```

**Exhibit 9.4.3.3-1. Sample Station List for the NWR**

### Comment Lines

The NWR HWR application interprets any line in the Station List that begins with a tilde (~) as information which will appear verbatim in the broadcast message. Such lines may appear anywhere in the Station List. Symbolic words (shown in Exhibit 9.4.3.3-2) which the HWR NWR application converts into text (according to the list discussed below), can be inserted into these lines. A comment line may contain references to two time zones. This is useful for WFOs that span two time zones. It is also useful for sites within the same time zone when one of the sites is in Arizona or Indiana, which are always on standard time. Place brackets around words that are to be output only during Daylight Savings Time to alleviate repetitive phrasing of the time zones during Standard Time.

<code>%DATE%</code>	-	the current date (e.g., August 6).
<code>%DAY%</code>	-	the current day of the week (e.g., Thursday).
<code>%TIME%</code>	-	the current hour (e.g., 9 AM).
<code>%TIMEZ%</code>	-	the current nominal hour and time zone (e.g., 9AM Pacific Daylight Time).
<code>%TIMEW%</code>	-	the product creation time in numerical format (e.g., 251908, which means 25th day of the month, 19th hour, 8th min).
<code>%HEADD%</code>	-	the NWS header date/time (e.g., 900 AM PACIFIC DAYLIGHT TIME THURSDAY AUGUST 6, 1998).
<code>%DDHMM%</code>	-	the current date of the month, nominal hour, and minute of the observation (e.g., 251900, which means 25th day of the month, 19th hour, 0th min).
<code>%EST%</code>	-	the current nominal hour and the Eastern Standard Time zone (e.g., 9 AM Eastern Standard Time).
<code>%MST%</code>	-	the current nominal hour and the Mountain Standard Time zone (e.g., 9 AM Mountain Standard Time).
<code>%EST5EDT%</code>	-	the current nominal hour and the Eastern Time zones (e.g., 9 AM Eastern Standard Time or 10 AM Eastern Daylight Time).
<code>%CST6CDT%</code>	-	the current nominal hour and the Central Time zones (e.g., 8 AM Central Standard Time or 9 AM Central Daylight Time).
<code>%MST7MDT%</code>	-	the current nominal hour and the Mountain Standard Time zone (e.g., 7 AM Mountain Standard Time or 8 AM Mountain Daylight Time).
<code>%PST8PDT%</code>	-	the current nominal hour and the Pacific Time zone (e.g., 6 AM Pacific Standard Time or 7 AM Pacific Daylight Time).
<code>%AST95ADT%</code>	-	the current nominal hour and the Alaska Time zone (e.g., 5 AM Alaska Standard Time or 6 AM Alaska Daylight Time).

**Exhibit 9.4.3.3-2. Symbolic Words for Use in Comment Lines**

Any line starting with the pound symbol “#” is interpreted as being an internal Station List comment and is not included in the HWR NWR output product.

Each Station List may contain several different sections:

- A Fixed Station Format Section identified by the **!!!!FF\_STATIONS** line.
- A Marine Format section identified by the **!!!!MAR\_STATIONS** line.
- A Summary Format section identified by the **!!!!SUM\_STATIONS** line.
- A Broadcast Frequency section identified by the **!!!!BRDCST\_FREQ** line.

The “@” may be used instead of the “~” at the beginning of the Fixed Format Station section, Marine Observations section, and Station Summary Group section of a station list. The “@” may also be used inside the Station Summary Group section of the HWR NWR as is discussed in the Station Summary Group section of this document. However, a maximum of 15 comment lines starting with either “@” or “~” may be used in a station list. When all stations are marked with a “-,” the “@” is used for all comments associated with a section, and all of the stations in the section are missing, nothing will be broadcast for this section, not even the comment line.

### Fixed Format Stations

1. Each Fixed Format Station section begins with **!!!!FF\_STATIONS**. Fixed format stations are identified by their four-character ICAO identifier (e.g., KCRW) in the order they are to be broadcast, one station per line.
2. Place a slash “/” on each side of the surface station METAR identifier.

3. Next, place the four-character ICAO identifier for the most representative SCP station followed by a slash, unless the SCP station ID is identical to the surface station ID. In such cases, it is not necessary to repeat the ID. Instead, place another "/" after the previous one.
  4. Next, place the missing station flag which is either the plus sign "+" or the minus sign "-."
- The "+" indicates that the corresponding station will always be broadcast, even if the weather elements are missing (e.g., "The report from Missoula was not available").
- The "-" indicates that the station will be ignored if all the weather elements for the station are missing.
5. Enter the fixed phrase station name after the missing station flag. As many as 30 characters may be used for the station name.

A sample Fixed Format Station section follows:

```
# Fixed Format Station section
!!!!FF_STATIONS
~These are the %TIMEZ% observations for the local area, on
~%DAY%, %DATE%.
/KDCA/KDCA/*Reagan National Airport;/KADW/+Andrews Air Force Base
/KDAA//Fort Belvoir
/KBWI//+B W I Airport
/KADW/KDCA/+Andrews Air Force Base
/KAKQ/KRIC/+Wakefield
```

**NOTE:** A Fixed Format Station section may contain a maximum of 20 station lines; however, you may have multiple Fixed Format Station sections.

### Station Substitution

If all of a station's observations are missing, another station may be used as a substitute. To specify a station substitution in the station list, place an asterisk after the first station identifier, a semicolon between the stations, and the missing station flag after the second station identifier. The "+" after the second station indicates that the first station will be output as missing if both stations are missing. A "-" after the second station indicates that both stations will be ignored if both stations are missing. For example,

```
/KDCA//*Reagan National Airport;/KADW/+ANDREWS AIR FORCE BASE
```

In the example, Reagan National Airport will normally be broadcast. If its observations are missing, the observation from Andrews Air Force Base will be broadcast. If both stations are missing, the output will state that the report from Reagan National Airport is not available.

## Marine Observations

1. Enter **!!!!MAR\_STATIONS** to identify that marine stations follow in the Station List. Marine stations are identified by their alphanumeric identifiers, which may be more than four characters (e.g., WECB, MISM1, 41002). They are listed in the order they are to be broadcast, one station per line.
2. Place one slash “/” before the identifier and two slashes after it.
3. After the second slash, place the missing station flag which is either the plus sign “+” or the minus sign “-.” For a discussion of the missing station flags, see the Fixed Format Stations subsection above.
4. Enter the marine station name after the missing station flag. As many as 30 characters may be used for the station name.

An sample Marine Observations Section follows.

```
# Marine Format
~Here are some CMAN reports.
!!!!MAR_STATIONS
/BLIA2//~Bligh Reef
/TTIW1//+Tatoosh Island
/MISML//~Matinicus Isle
/SAUF1//~St. Augustine
#
~Here are some buoy reports.
!!!!MAR_STATIONS
/46006//+Buoy 46006
/44014//~Buoy 44014
/42019//~Buoy 42019
/51003//+Buoy 51003
```

**NOTE:** A maximum of 10 stations is permitted in each **!!!!MAR\_STATIONS** section; however, you may have multiple sections.

## Station Summary Groups

Insert a tilde “~” and a comment line. This comment line will always be broadcast even if all data are missing or weather conditions are not similar and summary phrases are not created. Use the “@” instead of “~” to indicate to the program that the comment should be ignored if all stations within the summary group are missing.

1. Enter **!!!!WX\_CONDS** to identify a Station Summary group.
2. On the second line, list the weather elements to be summarized. The following weather elements may be summarized: sky/weather (element identifier SW), temperature in degrees Fahrenheit (element identifier TF), and temperatures in degrees Celsius (element identifier TC).
3. On the third line, enter **!!!!SUM\_STATIONS** to identify that the stations that follow it are to be summarized. List at least 3 but no more than 10 station identifiers, one

station per line, identified by their four-character ICAO identifier. Place a slash “/” on each side of the station identifier.

4. Next, place another four-character ICAO identifier for the closest SCP station followed by a slash, unless the station is the same as the first one on the line. In such cases, do not insert the ICAO identifier again, just place the second slash.
5. After the second slash, place the missing station flag which is either the plus sign “+” or the minus sign “-.”

The “+” indicates that the corresponding station will always be broadcast, even if the weather elements are missing. An example of the output in such cases is “**The report from Baton Rouge was not available.**”

The “-” indicates that the station will be ignored if all the weather elements for the station are missing. When using the “@” at the beginning of the comment line outside of the summary group, also use the minus sign “-” for the missing station flags for each station.

6. Enter the station name after the missing station flag. As many as 30 characters may be used for the station name.

Inside the summary group, the “@” symbol is used to indicate that a comment follows. Comments may be placed anywhere in the summary phrase group. These comments within the summary group are only broadcast when similarities of weather conditions force the creation of a summary phrase. For example,

```
# Summary Format
~Here are some observations outside the metro area.
!!!!WX_CONDS
SW TF TC
!!!!SUM_STATIONS
@Throughout the region,
/KHGR//*Hagerstown; /KNHK/+Patuxent River
/KMRB//+Martinsburg
/KSBY//+Salisbury
/KNHK//-Dover
/KCHO//-Charlottesville
/KADW//+Andrews Air Force Base
/KRIC//+Richmond
```

In this example, there’s a comment line identified by the tilde “~” outside of the summary group and a comment line inside the summary group identified by the “@.” The comment outside the group is always broadcast, whereas the comment inside the group is broadcast only when similarities of weather conditions force the creation of a summary phrase. Because the only weather elements eligible for summarizing, in this example and in this program, are sky/weather (SW), temperature in degrees Fahrenheit (TF), and temperatures in degrees Celsius (TC), there are four possible outcomes:

1. If both temperature and sky/weather conditions are uniform, the output will read one of two ways.

The first option is for the output to read as follows:

*“Here are some observations outside the metro area. Throughout the region, skies ranged from cloudy to mostly cloudy, and temperatures were in the mid and upper 30s.”*

In this example, the temperatures are phrased as a range rather than specific values. The forecaster is provided with a temperature phrasing option in the GUI. These criteria are that the temperature range is less than 5 degrees Fahrenheit and all of the temperatures are higher than 13 degrees Fahrenheit and lower than 99 degrees Fahrenheit.

The second option is for the output to read as follows:

*“Here are some observations outside the metro area. Throughout the region, skies ranged from cloudy to mostly cloudy, and temperatures were between 34 and 39 degrees.”*

In this example, the temperatures are phrased as being bounded by the specific lowest observed temperature and the specific highest observed temperature.

2. If the sky/weather conditions are uniform (sky conditions do not differ by more than one category) across the region but not the temperatures, the output will read as follows:

*“Here are some observations outside the metro area. Throughout the region, skies ranged from sunny to mostly sunny. It was 45 in Hagerstown, 58 in Martinsburg, 49 in Salisbury, and 53 in Dover. Charlottesville reported 51 degrees, Andrews Air Force Base 57, and Richmond 49.”*

**NOTE:** The HWR NWR application arranges only three to five stations in a sentence.

3. If the temperatures are uniform (within the range specified in the HWR Editor for NWS) but not the sky/weather conditions, the output will read in one of two ways.

The first option is for the output to read as follows:

*“Here are some observations outside the metro area. Throughout the region, temperatures were between 84 and 88 degrees. It was sunny at Hagerstown, Salisbury, and Andrews Air Force Base. It was mostly sunny at Martinsburg and Richmond. At Dover, it was partly sunny. At Charlottesville, it was cloudy.”*

In this example, the temperatures are worded as being bounded by the specific lowest observed temperature and the specific highest observed temperature. The forecaster is provided with a temperature phrasing option in the GUI.

The second option is for the output to read as follows:

*“Here are some observations outside the metro area. Throughout the region, temperatures were in the middle and upper 80s. It was sunny at Hagerstown, Salisbury, and Andrews Air Force Base. It was mostly sunny at Martinsburg and Richmond. At Dover, it was partly sunny. At Charlottesville, it was cloudy.”*

In this example, the temperatures are phrased as a range (e.g., temperatures were in the middle and upper 80s) rather than the specific values.

4. If neither temperatures nor sky/weather conditions are uniform, the output will read as follows:

*“Here are some observations outside the metro area. It was sunny, with a temperature of 34 at Hagerstown, 28 at Dover, and 26 at Richmond. Under mostly sunny skies, Martinsburg reported 22 degrees, and Charlottesville 35. At Salisbury, it was partly sunny, with a temperature of 36. At Andrews Air Force Base, it was cloudy with a temperature of 34.”*

**NOTE:** In the last example, the phrase “Throughout the region” was not part of the broadcast statement as that phrase is only included when there are similarities in the weather conditions.

### Broadcast Frequency Section

There is also a way to obtain additional variability from hour to hour for Fixed Phrase Format stations. Multiple broadcast records for each station list record may be created, each with a different fixed format for each station. Consequently, the probability with which each file is to be accessed must be provided in the station record. The program will randomly access the files according to the specified probability distribution. The total of the frequencies **MUST** be 100 (representing 100 percent). If only one broadcast record for a transmitter is needed, either omit the frequency from the station list record, or enter “100.” In the example below, the “10, 40, 50” values indicate that there are three broadcast records associated with this station list record. For example, assume this record is named CCCHWRNW5 (indicating that this is the file associated with the fifth output product). Also, assume the **hwrnwr** program is aware of three broadcast records, one of which will be selected this hour for product 5. **hwrnwr** will randomly generate a number to choose one of the three files. Thus, after multiple executions of the program, one would expect that broadcast record CCCHWRNW5.1 would be selected 10 percent of the time, while record CCCHWRNW5.2 would be selected 40 percent, and record CCCHWRNW5.3 would be selected 50 percent of the time. For example,

```
!!!!BRDCST_FREQ
10 40 50
# Fixed Station Format section
!!!!FF_STATIONS
~These are the %TIMEZ% observations for the local area, on %DAY%, %DATE%.
/KDCA/KDCA/+Reagan National Airport
/KDAA/--Fort Belvoir
/KBWI// *B W I Airport;/KADW/+Andrews
/KADW/KDCA/+Andrews
/KAKQ/KRIC/+Wakefield
#
# Summary Format
~Here are some observations outside the metro area.
!!!!WX_CONDS
SW TF
```



```

!!!!SUM_STATIONS
@Throughout the region,
/KMRB//+Martinsburg
/KHGR//+Hagerstown; /CDEV/+Dover
/KNHK//-Patuxent River
/KING//+Wilmington
/KSBY//+Salisbury
#
# Marine Format
~Here are some CMAN reports.
!!!!MAR_STATIONS
/BLIA2//-Bligh Reef
/TTIW1//+Tatoosh Island
/MISMI//-Matinicus Isle
/SAUF1//-St. Augustine
~Here are some buoy reports.
#
!!!!MAR_STATIONS
/46006//+Buoy 46006
/44014//-Buoy 44014
/42019//-Buoy 42019
/51003//+Buoy 51003

```

#### 9.4.3.4 *Creating a Broadcast Format File*

A Broadcast Format file (Exhibit 9.4.3.4-1) is created using the HWR NWR Broadcast Editor. Broadcast Format files contain Broadcast Format paragraphs that are used to create the broadcast text that is sent to the CRS. Broadcast Format paragraphs begin with the Station ID (enclosed in “/ /”) and end with “\$\$.” Broadcast Format paragraphs consist of verbatim text (i.e., to be broadcast verbatim) and symbolic text (i.e., to be replaced with data observations). The verbatim and symbolic text may be mixed in any manner that produces coherent broadcast text. Exhibit 9.4.3.4-2 shows the symbolic text that may be used.

You must have at least one Broadcast Format paragraph for each station (Fixed Format and Marine) in the associated Station List. Do not include Broadcast Format paragraphs for station summary groups. You will get an error message when the application runs, if the Broadcast Format file does not contain a Broadcast Format paragraph for a fixed format and Marine station in the associated Station List. Extra Broadcast Format paragraphs (that is, the station is not in the Station List, but is in the Broadcast Format file) are ignored.

**NOTE:** Broadcast Format files may contain a second Broadcast Format paragraph for some stations, refer to Section 9.4.3.6, *Providing Additional Variability for the NWR Broadcasts*.

```
##### format TDLHWRNW1
!!!!!!FF_STATIONS
/KDCA/At %ID%,{ %SW% was falling; %SW% was reported; it was %SW%; %SW% were
reported}
([V.V.], reducing the visibility to %V.V.%U).
  The temperature was %TF%U, the DEWPOINT %DF%, and the relative humidity %RR%
percent([HF], producing a heat index of %HF%).
  ([FF]The wind was %DD% at %FF%U([GG], gusting to %GG%)([WF], producing a wind
chill of %WF%). )
The pressure was %PP%U and %PT%. $$
#
/KDAA/At %ID%,{ %SW% was falling; %SW% was reported; it was %SW%; %SW% were
reported}
([V.V.], reducing the visibility to %V.V.%U).
  The temperature was %TF%U, the dewpoint %DF%, and the relative humidity %RR%
percent([HF], producing a heat index of %HF%).
  ([FF]The wind was %DD% at %FF%U([GG], gusting to %GG%)([WF], producing a wind
chill of %WF%). )
The pressure was %PP%U and %PT%. $$
#
/KBWI/At %ID%,{ %SW% was falling; %SW% was reported; it was %SW%; %SW% were
reported)
([V.V.], reducing the visibility to %V.V.%U).
  The temperature was %TF%U, the dewpoint %DF%, and the relative humidity %RR%
percent([HF], producing a heat index of %HF%).
  ([FF]The wind was %DD% at %FF%U([GG], gusting to %GG%)([WF], producing a wind
chill of %WF%). )
The pressure was %PP%U and %PT%. $$
/KDCA/Once again, at %ID% it was %TF%U {with %SW%,with %SW%;
under %SW% skies;with %SW%}. $$
#
!!!!!!MAR_STATIONS
/BLIA2/%ID% recorded winds from the %DD% at %FK%U. Sea temperature %SF%U. Air
temperature %TF%. Wave height %HW%U. Wave period %PW%U. $$
#
/TTIW1/%ID% reported a water temperature of %SF%. Air temperature %TF%. Wave
height %HW%U. Wave period %PW%U. $$
#
/MLSM1/The water temperature at %ID% was %SF%U. The air temperature %TF%. The
wave height %HW%U, and wave period %PW%U. $$
#
!!!!!!MAR_STATIONS
/46006/%ID% recorded winds from the %DD% at %FK%U. Swell height %HS%U. Swell
period %SP%. $$
#
/44014/%ID% recorded a swell height of %HS%U from the %SD%. $$
#
/42019/%ID% reported swell heights of %HS%U from the %SD%. $$
```

**Exhibit 9.4.3.4-1. Sample Broadcast Format File for NWR**

```

%ID% - Station name
%SW% - Sky/weather conditions.
%V.V.% - Visibility, if threshold specified in the GUI is met.
%TF% - Temperature (Fahrenheit).
%TC% - Temperature (Celsius).
%DF% - Dew point (Fahrenheit).
%DC% - Dew point (Celsius).
%RR% - Relative humidity.
%HF% - Heat index (Fahrenheit), if threshold specified in the GUI is met.
%HC% - Heat index (Celsius), if the threshold specified in the GUI is met.
%DD% - Wind direction (degrees)
%FF% - Wind speed (mph).
%FK% - Wind speed (kt).
%GG% - Wind gusts (mph).
%GK% - Wind gusts (kt).
%WF% - Wind chill index (Fahrenheit), if the threshold specified in the GUI is
met.
%WC% - Wind chill index (Celsius), if the threshold specified in the GUI is
met.
%PP% - Pressure (inches).
%PB% - Pressure (mb).
%PT% - Pressure tendency, if previous hour's pressure is available.
%SF% - Sea surface temperature (Fahrenheit).
%SC% - Sea surface temperature (Celsius).
%PW% - Wave period (s).
%HW% - Wave height (ft).
%SD% - Swell direction (degrees).
%HS% - Swell height (ft).
%SP% - Swell period (s).
%P1% - One hour precipitation amount (hundredths of an inch).
%P6% - Six hour precipitation amount (hundredths of an inch).

```

#### Exhibit 9.4.3.4-2. Symbolic Text for Use in Broadcast Format Files

It is very helpful to view the Station List file while editing the Broadcast Format file. This way you can easily view both files simultaneously.

For each product, multiple Broadcast Format files (1 through 9) may be created, each containing different Broadcast Format paragraphs for a given station. In this manner, when the HWR application selects different Broadcast Format files from hour to hour, there will be broadcast variation for the same station.

When initially installed, Product ID CCCHWRXXX contains a Broadcast Format template that may be used to create additional Broadcast Formats. Cut and paste as needed from the template.

#### ► To Create a Broadcast Format File

**Select:** A Product

**Select:** The Broadcast Format File number (1–9)

**Select:** **Broadcast** editor button

- The default HWR NWR text editor appears displaying the Broadcast Format File for the selected Product and Broadcast

Format File number. If no file exists, a pop-up will ask if you want to create one and will open a blank file in the text editor if you select Yes.

The following approach explains how to create Broadcast Format paragraphs from scratch.

► **To Create a Sample Hourly Weather Roundup Report**

1. Write out a sample of an Hourly Weather Roundup station report for all land and marine stations which will have a fixed format. With the land observations, start with the assumption that rain was observed, and no thresholds were met. Sentences don't need to be entirely grammatically correct, since they may be somewhat abbreviated in the normal broadcast fashion. However, commas must be inserted where a pause is required. For example,

*“ At Reagan National Airport, rain was falling. The temperature was 57 degrees, the dew point 56, and the relative humidity 97 percent. The pressure, 29.92 inches and falling.*

*The temperature was 56 degrees with rain at B W I Airport. The dew point 55, and the relative humidity 97 percent. The pressure, 29.97 inches and falling.*

*Rain was observed at Dulles Airport. The temperature 56 degrees, the dew point 56, and the relative humidity 100 percent. The pressure, 29.89 inches and steady.*

*Middle Nomad Buoy located 60 miles southeast of Norfolk recorded a south wind of 22 knots, swells 6 feet, air temperature 71 degrees, and water temperature 77 degrees.*

*Ship Discovery located at 38 degrees north latitude and 73 degrees west longitude recorded southeast winds at 15 knots, air temperature 59 degrees, water temperature 63 degrees, with 5 foot waves.”*

2. Open the desired Broadcast Format file and enter the text for the statements. Start each Broadcast Format Paragraph with the Station ID and end it with **\$\$**. See the example below.

*/KDCA/At Reagan National Airport, rain was falling. The temperature was 57 degrees, the dew point 56, and the relative humidity 97 percent. The pressure, 29.92 inches and falling.\$\$*

*#*

*/KBWI/The temperature was 56 degrees with rain at B W I Airport. The dew point 55, and the relative humidity 97 percent. The pressure, 29.97 inches and falling.\$\$*

*#*

*/KIAD/Rain was observed at Dulles Airport. The temperature 56 degrees, the dew point 56, and the relative humidity 100 percent. The pressure, 29.89 inches and steady.\$\$*

*#*

```
/BLIA2/Middle Nomad Buoy located 60 miles southeast of Norfolk recorded
a south wind 22 knots, swells 6 feet, air temperature 71 degrees, and
water temperature 77 degrees.$$
#
```

```
/WEBC/Ship Discovery located at 38 degrees north latitude and 73
degrees west longitude recorded southeast winds at 15 knots, air
temperature 59 degrees, water temperature 63 degrees, with 5 foot
waves.$$
```

This is a good time to compare the Station List with the Broadcast Format. You must have at least one Broadcast Format Paragraph for each Station (Fixed Format and Marine) in the Station List.

### ► Create Phrasing for Sky/Weather Conditions

The phrasing for the sky/weather conditions is the most complicated task. You must create four phrases that produce a coherent description of the sky/weather conditions. The HWR NWR application selects the correct format based upon the current sky/weather conditions.

1. Substitute, in turn, each of the following weather conditions in place of rain in the above examples, ensuring that the sentences still sound acceptable: sleet, snow, hail, drizzle, light snow, light rain, heavy snow, and heavy rain. If necessary, change any phrase so that all of these weather conditions, including rain, sound correct.
2. Place curly braces (**{}**) around the phrases with rain in the examples. Inside the curly braces, place a semicolon after the phrase with rain, followed by a phrase for the weather, assuming fog was reported instead of rain. For example,

```
/KDCA/At Reagan National Airport, {rain was falling; fog was reported}.
The temperature...
```

```
/KBWI/The temperature was 56 degrees {with rain; with fog} at B W I
airport...
```

```
/KIAD/{Rain was observed; Fog was observed} at Dulles Airport. The
temperature ..."
```

3. Substitute each of the following weather conditions in place of fog in the above examples, ensuring that the sentences still sound acceptable: thunder, volcanic ash, dust, sand, haze, smoke, spray, a dust devil, a squall, a thunderstorm, a thundershower, blowing snow, blowing dust, blowing sand, and blowing spray. If necessary, change the phrase so that it sounds correct with any of these weather elements. When substituting thunder for fog, you might not like the phrase, "thunder was observed" for the Dulles report. If not, change the phrase to something acceptable for all of the weather elements in this category, such as "thunder was reported."
4. Place another semicolon after the phrase with fog. Create a phrase for sunny conditions. The CFS pauses for both periods and commas, thus the

incomplete sentence in the following example will sound correct, because it connects well with the phrase that follows it. For example,

```
/KDCA/At Reagan National Airport, {rain was falling; fog was reported;
under sunny skies}. The temperature ...
```

```
/KBWI/The temperature was 56 degrees {with rain; with fog; with sunny
skies} at B W I Airport...
```

```
/KIAD/{Rain was observed; Fog was reported; It was sunny} at Dulles
Airport. The temperature ..."
```

5. Substitute each of the following sky conditions in place of sunny in the above examples to ensure that the sentences still sound acceptable: cloudy, mostly cloudy, partly cloudy, clear, partly sunny, mostly sunny, and fair. If necessary, change any phrase so that all of these sky conditions, including “sunny,” sound correct.
6. Place another semicolon after the phrase with sunny sky conditions. Create a phrase for weather conditions stated in plural form (e.g., snow showers), or for multiple weather conditions (e.g., drizzle and fog). To make the file easier to read, you may place carriage returns anywhere. However, don’t drop the necessary spaces and punctuation marks. For example,

```
/KDCA/At Reagan National Airport, {rain was falling; fog was reported;
under sunny skies; snow showers were reported}.
The temperature was 57 degrees, the dew point 56, and the relative
humidity 97 percent.
The pressure 29.92 inches and falling.$$
#
```

```
/KBWI/ The temperature was 56 degrees
{with rain; with fog; with sunny skies; with snow showers} at B W I
airport.
The dew point 55, and the relative humidity 97 percent.
The pressure 29.97 inches and falling.$$
#
```

```
/KIAD/{Rain was observed; Fog was reported; It was sunny; Snow showers
were observed} at Dulles Airport.
The temperature 56 degrees, the dew point 56, and the relative humidity
100 percent.
The pressure 29.89 inches and steady.$$
#
```

```
/BLIA2/Middle Nomad Buoy located 60 miles southeast of Norfolk recorded
a south wind 22 knots, swells 6 feet, air temperature 71 degrees, and
water temperature 77 degrees.$$
#
```

```
/WEBC/Ship Discovery located at 38 degrees north latitude and 74
degrees west longitude recorded southeast winds at 15 knots, air
temperature 59 degrees, water temperature 63 degrees, with 5 foot
waves.$$
```

7. Substitute each of the following weather conditions in place of snow showers in the above examples, ensuring that the sentences still sound acceptable: sleet showers, rain showers, and snow flurries. If necessary, change any phrase so that all of these weather conditions, including snow showers, sound correct. Also, try some combinations of multiple weather conditions to ensure that these combinations also sound acceptable (e.g., “snow and blowing snow were observed”).

► **To Add Threshold Phrases**

1. Decide which weather elements should be broadcast only if their threshold values have been met (e.g., Wind Speed, Wind Gust, Visibility, Heat Index, and Wind Chill Index).
2. Place in parentheses the phrases describing all the threshold-dependent weather elements which you are requesting, in the correct locations in the paragraph for each station. Be certain to determine if the punctuation marks and spaces belong inside or outside of the parentheses. It’s also possible to embed parentheses within parentheses. This is necessary because the entire sentence may be dependent on the threshold of a particular weather element, and if that threshold is met, another weather element may control the broadcast of a phrase within the sentence. For example,

/KDCA/At Reagan National Airport,  
 {rain was falling; fog was reported; under sunny skies; snow showers  
 were reported}

**(, which reduced the visibility to 3/4 of a mile).**

The temperature was 57 degrees,

**(, the dew point 56,)**

and the relative humidity 97 percent

**(, producing a heat index of 104 degrees).**

**(The wind northeast at 12 miles an hour [, gusting to 27])**

**[, producing a wind chill of 8 degrees].)**

The pressure 29.92 inches and falling.\$\$

#

/KBWI/The temperature was 56 degrees,

{with rain; with fog; with sunny skies; with snow showers}

**(, and a visibility of ½ mile)** at B W I Airport. The dew point 55, and  
 the relative humidity 97 percent

**(, yielding a heat index of 98).**

**(The wind [, east at 14 miles an hour], with gusts to 29 [, which makes  
 the temperature feel like 17 degrees].)**

The pressure 29.97 inches and falling.\$\$

#

/KIAD/{Rain was observed; Fog was reported; It was sunny; Snow showers  
 were observed}

**(, which reduced the visibility to 1/4 of a mile)** at Dulles Airport.

The temperature 56 degrees

**(, the dew point 56,)**

and the relative humidity 100 percent.

**(The combination of temperature and humidity feels like 97 degrees.)**

```
(Strong winds from the north [, at 11 miles an hour] [, gusting to 22],
are producing a wind chill of 23 degrees.)
The pressure 29.89 inches and steady.$$
#
/BLIA2/Middle Nomad Buoy located 60 miles southeast of Norfolk recorded
a south wind 22 knots, swells 6 feet, air temperature 71 degrees, and
water temperature 77 degrees.$$
#
/WEBC/Ship Discovery located at 38 degrees north latitude and 74
degrees west longitude recorded southeast winds at 15 knots, air
temperature 59 degrees, water temperature 63 degrees, with 5 foot
waves.$$
```

### ► To Add Symbolic Weather Elements

Replace values with symbolic words, using the key in Exhibit 9.4.3.4-2. Place a **U** (for units) after the symbolic word to indicate that both the value and the units are to be output where desired. For example, if the temperature was 53 degrees, **%TF%U** would result in **53 degrees**. On the other hand, **%TF%** would only be replaced with 53. Sky/weather, wind direction, heat index, wind chill index, swell direction, and pressure tendency have no units and should not be used with the **U** character. Also, the plural form of the unit is used whenever the value is not **1** or **-1**.

### ► To Add Substitute Stations

Create paragraphs for stations which substitute for another station, even if the format is identical. In our example, Andrews Air Force Base is a substitute station for Reagan National Airport.

```
/KDCA/At Reagan National Airport,
{%SW% was falling; %SW% was reported; under %SW% skies; %SW% were reported}
(, which reduced the visibility to %V.V.%U).
The temperature was %TF%U(, the dew point %DF%), and the relative humidity
%RR%U
(, producing a heat index of %HF%).
(The wind %DD% at %FF%U(, gusting to %GG%)(, producing a wind chill of %WF%).
)
The pressure %PP%U and %PT%. $$
#
/KADW/At Andrews Air Force Base,
{%SW% was falling; %SW% was reported; under %SW% skies; %SW% were reported}
(, which reduced the visibility to %V.V.%U).

The temperature was %TF%U(, the dew point %DF%), and the relative humidity
%RR%U
(, producing a heat index of %HF%U).

(The wind %DD% at %FF%U[, gusting to %GG%] [, producing a wind chill of
%WF%U].)
The pressure %PP%U and %PT%. $$
/KBWI/The temperature was %TF%U{ with %SW%; with %SW%; with %SW% skies; with
%SW%}
```



```
(, and a visibility of %V.V.%U) at B W I Airport. The dew point %DF%, and the
relative humidity %RR%U(, yielding a heat index of %HF%).
(The wind %DD%( at %FF%U), with gusts to %GG%(, which makes the temperature
feel like %WF%). )
The pressure %PP%U and %PT%. $$
#
/KIAD/{%SW% was observed; %SW% was reported; it was %SW%; %SW% were observed}
(, which reduced the visibility to %V.V.%U) at Dulles Airport.
The temperature %TF%U(, the dew point %DF%), and the relative humidity %RR%U.
(The combination of temperature and humidity feels like %HF%U.) (Strong winds
from the %DD%( at %FF%U)(, gusting to %GG%), are producing a wind chill of
%WF%U. )
The pressure %PP%U and %PT%. $$
#
/BLIA2/Middle Nomad Buoy located 60 miles southeast of Norfolk recorded %DD%
winds %FK%U, swells %HS%U, air temperature %TF%U, and water temperature
%SF%U. $$
#
/WEBC/Ship Discovery located at 38 degrees north latitude and 74 degrees west
longitude recorded %DD% winds at %FK%U, air temperature %TF%U, water
temperature %SF%U, with %HW% foot waves. $$
```

### ► To Choose Weather Elements to Control Threshold Phrases

At the beginning of each threshold phrase, indicate by placing into brackets, the weather element which controls the reporting of the phrase. This is necessary, because some phrases contain two elements for which there are thresholds. For example,

```
/KDCA/At Reagan National Airport,
{ %SW% was falling; %SW% was reported; under %SW% skies; %SW% were reported}
([V.V.], which reduced the visibility to %V.V.%U).
The temperature was %TF%U([DF], the dew point %DF%), and the relative humidity
%RR%U
([HF], producing a heat index of %HF%U).
([FF] The wind %DD% at %FF%U([GG], gusting to %GG%)
([WF], producing a wind chill of %WF%U). )
The pressure %PP%U and %PT%. $$
#
/KADW/At Andrews Air Force Base,
{ %SW% was falling; %SW% was reported; under %SW% skies; %SW% were reported}
([V.V.], which reduced the visibility to %V.V.%U).
The temperature was %TF%U([DF], the dew point %DF%), and the relative humidity
%RR%U
([HF], producing a heat index of %HF%U).
([FF] The wind %DD% at %FF%U([GG], gusting to %GG%)
([WF], producing a wind chill of %WF%U). )
The pressure %PP%U and %PT%. $$
#
/KBWI/The temperature was %TF%U{ with %SW%; with %SW%; with %SW% skies; with
%SW%}
([V.V.], and a visibility of %V.V.%U) at B W I Airport. The dew point %DF%,
and the relative humidity %RR%U
([HF], yielding a heat index of %HF%).
([GG] The wind %DD% ([FF]at %FF%U),
with gusts to %GG%
([WF], which makes the temperature feel like %WF%). )
```

```

The pressure %PP%U and %PT%. $$
#
/KIAD/{%SW% was observed; %SW% was reported; it was %SW%; %SW% were observed}
([V.V.], which reduced the visibility to %V.V.%U) at Dulles Airport. The
temperature was %TF%U([DF], the dew point %DF%), and the relative humidity
%RR%U.
([HF] The combination of temperature and humidity feels like %HF%U.)
([WF]strong winds from the %DD%
([FF]at %FF%U)([GG], gusting to %GG%), are producing a wind chill of %WF%U. )
The pressure %PP%U and %PT%. $$
#
/BLIA2/Middle Nomad Buoy located 60 miles southeast of Norfolk recorded %DD%
winds %FK%U, swells %HS%U, air temperature %TF%U, and water temperature
%SF%U. $$
#
/WEBC/Ship Discovery located at 38 degrees north latitude and 74 degrees west
longitude recorded %DD% winds at %FK%U, air temperature %TF%U, water
temperature %SF%U, with %HW% foot waves. $$

```

### 9.4.3.5 Creating a Default Format File

For each product, you must also create a **Default Format** file. This file appears as Brdcast #0 in the NWR GUI. The Default Format is output only when one or more weather elements are missing from a decoded station. The Default Format is needed since the Broadcast Format permits the forecaster to compose output in an almost unlimited manner, and the HWR NWR application will not necessarily be able to coherently drop missing weather elements.

Consequently, the Default Format **MUST** conform to more rigid standards. Whereas the Broadcast Format File requires an entry for each station, the Default Format requires only one Broadcast Format Paragraph for land stations and one for marine stations. An example of a Default Format file is shown in Exhibit 9.4.3.5-1.

```

# format CCCNNNXXX
#
!!!!!!FF_STATIONS
At %ID%, { %SW% was falling; %SW% was reported; it was %SW%; %SW% were reported}.
The visibility was %V.V.%U.
  The temperature was %TF%U, and the dewpoint %DF%.
  The wind was %DD%, at %FF%.
  The pressure was %PP%U, and %PT%. $$
#
!!!!!!MAR_STATIONS
At %ID%, winds were %DD%, at %FK%U. Sea temperature %SF%U.
  Air temperature %TF%U. Wave height %HW%U. Wave period %PW%U.
  Swell direction %SD%, swell height %HS%, and swell period %SP%. $$

```

**Exhibit 9.4.3.5-1. Sample Default Format File**

The initial installation of the HWR NWR included a template for the default format. You may edit this template to match your requirements, or you may wish to follow the steps described below.

#### ► To Create a Default Format File

**Select:** A Product

**Select:** The **Broadcast Editor** button, Brdcst #0

- The default HWR NWR text editor appears so that you can type in the Default Format file for the selected Product

► **To Create Sample Default Phrases for Land and Marine Observations**

1. Write out a sample HWR for a land station and one for a marine station. Make sure that the HWR is constructed so that a punctuation mark follows the expression of each weather element. For example,

*“ At Reagan National Airport, rain was reported. The temperature was 57 degrees, the dewpoint 56, and the relative humidity 97 percent. The pressure 29.92 inches, and falling.*

*Middle Nomad Buoy recorded, a south wind, 22 knots, swells 6 feet, air temperature 59 degrees, water temperature 63 degrees, with wave height 5 feet.”*

In the above example, notice that if any of the weather elements are missing, the program can skip to the next punctuation mark, and the sentence is still readable, although it may not be grammatically correct. For example, if the temperature is missing at Reagan National Airport, the following phrase will be broadcast:

*“ At Reagan National Airport, rain was reported. The dewpoint 56. The pressure 29.92 inches, and falling.”*

If the pressure is missing, the entire sentence is skipped, because the next punctuation mark is the end of the sentence.

**NOTE:** The program cannot calculate the relative humidity without the temperature or a pressure tendency without a current or previous pressure.

2. Via the Default Format Editor, enter the text to match the HWR in Step 1. Wherever the sky/weather conditions are requested, substitute phrases for obstructions to vision, sky conditions, and multiple sky/weather conditions, in an identical manner to the technique described in Section 9.3.3.4. For example,

At Reagan National Airport,  
 { rain was falling; fog was reported; under sunny skies; snow showers were reported}.

The temperature was 57 degrees(, the dewpoint 56,) and the relative humidity 97 percent.

The pressure was 29.92 inches and falling.

Middle Nomad Buoy recorded a south wind, 22 knots, swells 6 feet, air temperature 59 degrees, water temperature 63 degrees, with wave height 5 feet.

- Threshold values may be added, but be careful that the sentence will make sense if any weather element is missing.

```
At Reagan National Airport,
{ rain was falling; fog was reported; under sunny skies; snow showers
were reported}.
```

```
The temperature was 57 degrees, the dewpoint 56, and the relative
humidity 97 percent (, producing a heat index of 104 degrees).
The pressure was 29.92 inches and falling.
```

```
Middle Nomad Buoy recorded, a south wind, 22 knots, swells 6 feet, air
temperature 59 degrees Fahrenheit, water temperature 63 degrees
Fahrenheit, with wave height 5 feet.
```

- Insert symbolic words, using the key in Exhibit 9.4.3.4-2, where observation values are to be placed. Indicate the weather element that controls the reporting of the threshold phrase. Examples are as follows:

```
At %ID%,
{ %SW% was falling; %SW% was reported; under %SW% skies; %SW% were
reported}.
```

```
The temperature was %TF%U([DF], the dewpoint %DF%), and the relative
humidity %RR%U
([HF], producing a heat index of %HF% degrees).
```

```
The pressure was %PP%U and %PT%.
%ID% recorded, a %DD% wind, %FK%U, swells %HS%U, air temperature %TF%U,
water temperature %SF%U, with wave height %HW%U.
```

- Finally, add the section identifiers and end markers \$\$\$. You may also add additional comments as needed.

```
# This is the Default Format File for CCCHWRNWL
#
#Fixed Format Station Section
!!!!FF_STATIONS
At %ID%,

{ %SW% was falling; %SW% was reported; under %SW% skies; %SW% were
reported}.
The temperature was %TF%U([DF], the dewpoint %DF%), and the relative
humidity %RR%U

([HF], producing a heat index of %HF% degrees).
The pressure was %PP%U and %PT%.$$
#

#Marine Station Section
!!!!MAR_STATIONS
%ID% recorded, a %DD% wind, %FK%U, swells %HS%U, air temperature %TF%U,
water temperature %SF%U, with wave height %HW%U.$$
```

### 9.4.3.6 Providing Additional Variability for the NWR Broadcasts

The capability is also provided to modify the output in three additional ways:

1. By producing variability in the phrases for a station from hour to hour;
2. By including a station in both the fixed phrase and summary group stations; and
3. By recapping the weather conditions for one or more stations.

► **To Create Hour to Hour Variability**

There is also a way to obtain additional variability from hour to hour for the Fixed Phrase Format stations. Multiple Broadcast Format files, each with a different fixed phrase format for the stations in the Station List, may be created. To create different Broadcast Format files for a product, specify a different number before selecting the **Broadcast Format Editor** button.

When multiple **Broadcast Format** files are provided for a product, the probability with which each file is to be accessed must be provided in the Station List. To create broadcast variability, create a frequency section at the beginning of the Station List.

The first line in the section contains the frequency section indicator, **!!!!BRDCST\_FREQ**.

The next line contains the values that determine the frequency of use. The total of the frequencies **MUST** be 100 (representing 100 percent). If only one broadcast record for a transmitter is needed, either omit the frequency section from the station list record, or enter “100.”

In the example below, the “10, 40, 50” values indicate that there are three broadcast records associated with this Station List. The HWR NWR application randomly generates a number to choose one of the three files. Assuming that this is the beginning of the Station List for Product CCCWRNW5, you would expect, after multiple executions of the application that

- Broadcast Format File CCCHWRNW5.1 would be selected 10 percent of the time.
- Broadcast Format File CCCHWRNW5.2 would be selected 40 percent of the time.
- Broadcast Format File CCCHWRNW5.3 would be selected 50 percent of the time.

For example,

```
!!!!BRDCST_FREQ
10 40 50
# Fixed Station Format section
!!!!FF_STATIONS
~These are the %TIMEZ% observations for the local area, on      %DAY%,
%DATE%.
/KDCA/KDCA/+Reagan National Airport
...
```

► **To Add Stations to Both Fixed Phrase and Summary Groups**

Sometimes, when the geography warrants, it may be desirable to place a station into the fixed format section, and also to include it in a summary group. In this manner, a summary which encompasses the region in which the fixed phrase format station is a part will be more accurate. For example, if the Baltimore Washington International Airport (BWI) is in a fixed phrase broadcast format, a group of stations which constitutes Maryland would not be entirely complete without its observations. Thus, BWI should appear twice in the station list record, once as a Fixed Phrase Format station, and once within the group that comprises Maryland. Therefore, temperature and sky/weather conditions specifically for BWI will be broadcast twice when the sky/weather or temperature in degrees Fahrenheit are within the summary group thresholds. For example,

```
!!!!BRDCST_FREQ
10 40 50
# Fixed Format Station section
!!!!FF_STATIONS
~These are the %TIMEZ% observations for the local area, on
~%DAY%, %DATE%.
/KDCA/KDCA/+Reagan National Airport
/KDAA//Fort Belvoir
/KBWI//*B W I Airport;/KADW/+Andrews
/KADW/KDCA/+Andrews
/KAKQ/KRIC/+Wakefield
#
# Summary Format
~Here are some observations for Maryland.
!!!!WX_CONDS
SW TF
!!!!SUM_STATIONS
@Throughout the region,

/KBWI//+Baltimore Washington International Airport
/KHGR//+Hagerstown
/KNHK//Patuxent River
/KSBY//+Salisbury
#
# Marine Format
~Here are some CMAN reports.
!!!!MAR_STATIONS
/BLIA2//Bligh Reef
/TTIW1//+Tatoosh Island
~Here are some buoy reports.
#
!!!!MAR_STATIONS
/46006//+Buoy 46006
/44014//+Buoy 44014
#
```

► **To Recap the Weather Conditions**

At many WFOs, it is a common practice to repeat the temperature and weather for a major city or cities at the end of a roundup. To set this up in the Broadcast Format file, enter a second Broadcast Format paragraph for these stations using the Format guidelines described previously. In the associated Station List, re-enter

the stations at the end of the list, this time using a station flag of “&.” This instructs the program to search for that station’s second Broadcast Paragraph in the Broadcast Format file. If the observation is missing, that station will be treated as a “-” station and ignored. For example,

```
!!!!BRDCST_FREQ
10 40 50
# Fixed Station Format section
!!!!FF_STATIONS
/KDCA/KDCA/+Reagan National Airport
/KADW/KDCA/-Andrews Air Force Base
/KBWI//+B W I Airport
/KIAD//+Dulles
/KDCA//&Reagan National Airport
```

The corresponding Broadcast Format file needs to be modified to incorporate the second entry for this station. For example,

```
/KDCA/At Reagan National Airport,
{ %SW% was falling; %SW% was reported; under %SW% skies; %SW% were reported}
([V.V.], which reduced the visibility to %V.V.%U).
The temperature was %TF%U([DF], the dew point %DF%), and the relative humidity
%RR%U
([HF], producing a heat index of %HF%U).
([FF]The wind %DD% at %FF%U([GG], gusting to %GG%)
([WF], producing a wind chill of %WF%U). )
The pressure %PP%U and %PT%.$$

/KADW/At Andrews Air Force Base,{ %SW% was falling; %SW% was reported; under
%SW% skies; %SW% were reported}
([V.V.], which reduced the visibility to %V.V.%U).
The temperature was %TF%U([DF], the dew point %DF%), and the relative humidity
%RR%U
([HF], producing a heat index of %HF%U).
([FF]THE wind %DD% at %FF%U([GG], gusting to %GG%)
([WF], producing a wind chill of %WF%U). )
The pressure %PP%U and %PT%.$$

/KBWI/The temperature was %TF%U{ with %SW%; with %SW%; with %SW% skies; with
%SW%}
([V.V.], and a visibility of %V.V.%U) at B W I Airport. The dew point %DF%,
and the relative humidity %RR%U
([HF], yielding a heat index of %HF%).
([GG]The wind %DD% ([FF]at %FF%U)
with gusts to %GG%
([WF], which makes the temperature feel like %WF%). )
The pressure %PP%U and %PT%.$$

/KIAD/{%SW% was observed; %SW% was reported; It was %SW%; %SW% were observed}
([V.V.], which reduced the visibility to %V.V.%U) at Dulles Airport. The
temperature was %TF%U([DF], the dew point %DF%), and the relative humidity
%RR%U.
([HF]The combination of temperature and humidity feels like %HF%U.)
([WF]Strong winds from the %DD%
([FF]at %FF%U)([GG], gusting to %GG%), are producing a wind chill of %WF%U. )
The pressure %PP%U and %PT%.$$

/KDCA/Once again, at Reagan National Airport it was %TF%U {with %SW%;with
%SW%;under %SW% skies;with %SW%}.
```

### 9.4.3.7 *Treatment of Missing Data*

The HWR NWR application treats missing data in the various ways described below.

#### **For Fixed Format Station Observations**

If the entire station is missing and the station is marked in the station list record with a “+” symbol, the site is broadcast as “**not available.**”

If the entire station is missing and the station is marked with a “-” symbol, the site is dropped from the broadcast.

If the entire station is missing and the station is marked with a “\*” symbol, the second station substitutes for the first. If the second station is also missing, the FIRST station is broadcast as “**not available,**” or not broadcast at all, depending on the symbol with the second station.

If one or more non-threshold weather elements are missing, the fixed format established, in the Broadcast Format file, for that station are ignored, and the program reverts to the default format. One or more missing weather elements can be handled in conjunction with the default format. A default format is necessary because there is virtually an unlimited number of phrases that can be established by the users, and the HWR NWR application cannot realistically be programmed to structure a new sentence required by the absence of the missing weather elements.

#### **For Summary Group Stations**

Any station marked with a “+” whose observations are missing is reported as “**not available,**” and the observations for the remaining stations are grouped but not summarized.

A station marked with a “-” whose observations are missing is dropped from the broadcast, and the summary for the remaining stations is grouped, but not summarized.

If the observations for a station are missing and the station is marked with a “\*” symbol, the second station is substituted for the first. If both stations are missing, the FIRST station is reported as “**not available**” or not reported at all, depending on the symbol associated with the second station. The observations for the remaining stations are grouped but not summarized.

If only one of the two (sky/weather and temperature) weather elements is missing for any station, the missing element is not summarized for the remaining stations, but the available weather element remains eligible for summarizing.

When all stations are marked with a “-,” the “@” is used for all comment lines associated with the summary phrase, and all of the stations in the summary group are missing, nothing will be broadcast for this summary phrase, not even the comment line.



### For ASOS Stations

For ASOS stations, all of the above rules hold. However, there is an additional consideration, because low-level cloud cover observations are supplemented with satellite-derived middle- and upper-level cloud cover observations. The additional considerations are as follows:

If the ASOS cloud cover observation is missing but the SCP product, which contains information on only middle and high level cloud cover is available, the cloud cover is considered **missing**.

If the ASOS observation shows overcast conditions, the SCP product is not needed, since the sky conditions will be reported as **cloudy**.

If the ASOS observation shows broken clouds, the SCP product will be accessed to determine if the sky is overcast. If the SCP product is missing, the sky conditions will be reported as “**PARTLY SUNNY**” or “**MOSTLY CLOUDY**,” depending on the time of day.

If the ASOS observation shows clear skies or scattered clouds, the SCP product will be accessed to determine if the higher level sky conditions are cloudier. If the SCP product is missing, the sky conditions will either be considered missing, or reported as “**FAIR**,” depending on the forecaster’s preformat selection.

#### 9.4.3.8 Cautions

Some important points that should be considered while setting up the HWR NWR application follow.

1. Punctuation is very important, since the voice synthesizer will be confused by spaces preceding commas and periods. Therefore, be sure to check the printout when initially setting up and testing your files.
2. When it is desirable to repeat an observation for a station within the **same** fixed format group, be sure that the first entry contains a station flag of “+” or “-,” and that only the second entry in the station list record contains the “&” station flag.
3. There must be **four** sky/weather condition phrases for each fixed format station, even if two or more of the four sky/weather types are to be broadcast identically.
4. One or more missing or erroneous weather elements from a fixed format station’s observation cause the application to revert to a default format. This is necessary because the program is otherwise incapable of patching together the remaining phrases to form a coherent report. Check the station’s reported observation first whenever an unexpected output is encountered.
5. A maximum of 15 comment lines starting with either “@” or “~” may be used in a station list. When all stations are marked with a “-,” the “@” instead of a “~” is used at the beginning of a section, and all of the stations in the section are missing, nothing will be broadcast for this section, not even the comment line.

## 9.5 *Aviation Forecast Preparation System*

See [www.nws.noaa.gov/mdl/pgb/AvnFPS/3.2/html/index.html](http://www.nws.noaa.gov/mdl/pgb/AvnFPS/3.2/html/index.html).

### 9.5.1 *System Overview*

AvnFPS is implemented with a series of server and client processes that communicate via TCP sockets. The servers run on hosts where the data are readily available. Clients run on workstations which do not need direct access to the data. The client may be located on a non-AWIPS system and does not have to be within the same network segment. Data request servers (**avndrs**) are responsible for delivering data to clients. Data ingest servers (**avndis**) monitor data received by AWIPS and store them in a modified format in the AvnFPS database. A notification system (**avnserver**) is responsible for alerting the clients when new data are received. The AvnFPS database can be distributed among several hosts.

AvnFPS is written mostly in the Python programming language. Remote communication features are implemented with the help of Python Remote Objects (PYRO). PYRO is an advanced and powerful Distributed Object Technology system, written entirely in Python, which resembles Java's Remote Method Invocation (RMI). TAF and METAR decoders utilize Toy Parser Generator (TPG), also a Python module. Graphical interfaces are written in Tkinter. The AvnFPS distribution comes with its own version of the above tools, and is independent of AWIPS COTS.

Network Attached Storage eliminates the need for a distributed server configuration, as all the data are visible from a single host. The standard configuration is shown in Exhibit 9.5.1-1.

**NOTE:** The data flow diagram shows servers running on PX2, however, any Red Hat™ host on an AWIPS network would do. The standard installation puts the servers on PX2.

#### 9.5.1.1 *Name and Event Server*

The **avnserver** process stores the names and locations of all objects used by AvnFPS servers, and it provides these names and locations to all other AvnFPS processes. Additionally, **avnserver** other task is to provide a notification mechanism between servers and clients. Thus, **avnserver** combines PYRO's name and event servers. One and only one instance of **avnserver** should run within a WFO cluster. A client first connects to **avnserver** to get information about the locations of data request servers and to subscribe for notifications. Client processes do not have to run on hosts at the same WFO as the data servers although this feature is generally not used. An access list of valid hosts, maintained in a configuration file, is used to provide host based access control. **avnserver** must be running before any other AvnFPS servers or clients can be successfully started.

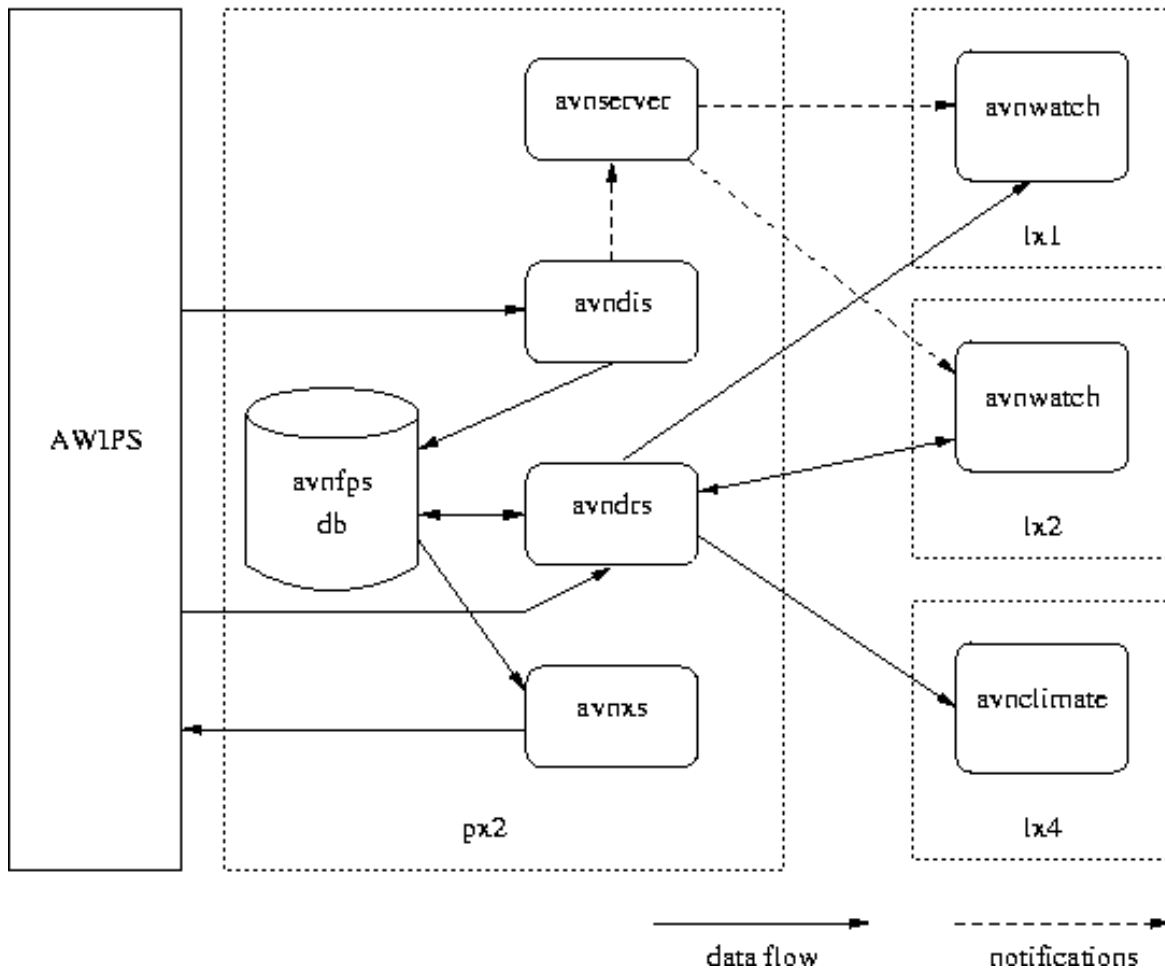

Exhibit 9.5.1-1. Data Flow Diagram

The application **avninit** is used to launch AvnFPS servers and in a certain order. Users typically do not have to be concerned about the servers. It is **avninit**'s job to ensure that all servers are running and restart them if they fail. However, command argument details for each server are provided here for their usefulness in troubleshooting, should it be necessary to start them by hand.

The **avnserver** program accepts the following command line arguments:

**TYPE:** `avnserver [-d] -n host`

- where **host** is the host name where the process will run. Obviously, this value could be retrieved from the operating system. This argument, however, is needed to properly handle failover situations. The optional flag **-d** tells the program to not detach itself from the terminal session, in other words, to run in the foreground.

### 9.5.1.2 Data Ingest Server

An instance of **avndis** monitors AWIPS data directories via **gamin** [Gamin]. **avndis** is a threaded application: for each data source, there is a dedicated thread that processes the data. Which server instance processes which data is determined by the server configuration file `etc/server.cfg`. **avndis** receives a notification from the **gamin** server when a file in a monitored directory is created or modified. The server, or parent process, then passes the file name to the appropriate thread. The thread processes the file's content, writes data to AvnFPS database and returns information back to the parent process. The parent process then sends notification to **avnserver**. A client that subscribed to the server will then receive this notification. The threads that are currently implemented are listed in Table 9.5.1.2-1.

**Table 9.5.1.2-1. avndis Threads**

Thread	Function
text	Processes text products: TAFs, METARs, TWEBs and CCFPs.
ltg	Processes lightning data.
rltg	Processes regression-based lightning forecasts data.
llws	Calculates Low Level Wind Shear value. The data sources are radar data (VWP) and METAR observations.
file	Monitors files written by an external program in a format that can be processed directly by AvnFPS clients. Currently used to process IFPS grids.
guid	Monitors directories where guidance sources arrive over the AWIPS WAN. Typically, BUFR MOS and raw model output from NCEP.

Every 30 seconds, **avndis** sends an **ALIVE** message that is used by clients to monitor the state of AvnFPS servers and alert users when something goes wrong.

The program accepts the following arguments:

- TYPE:**            **avndis** [-d] -n host
- where *host* is the host name where the process will run. The optional flag **-d** tells the program to not detach itself from the terminal session (i.e., to run in the foreground). See Section 9.5.3.1, “Starting AvnFPS Servers,” for an example of a **ps** listing.

### 9.5.1.3 Data Request Server

**avndrs** is mainly responsible for providing data to AvnFPS clients. The data source is the AvnFPS database, however, it can also directly access AWIPS files such as **netCDF** data in the `/data/fixa` tree. The other function of **avndrs** is to write forecasts prepared by the clients to a queue where they are then processed by the transmission server **avnxs**. Each instance of **avndrs** is capable of processing all data sources.

Every 30 seconds, **avndrs** sends an **ALIVE** message that is used by clients to monitor the state of the AvnFPS servers and alert users when something is wrong.

The program accepts the following arguments:

- TYPE:**        **avndrs [-d] -n host**
- where **host** is the host name where the process will run. The optional flag **-d** tells the program to not detach itself from the terminal session (i.e., to run in the foreground). See Section 9.5.3.1, “Starting AvnFPS Servers,” for an example of a **ps** listing.

#### 9.5.1.4 *Transmission Server*

The transmission server, **avnxs**, provides a bridge between AvnFPS and the AWIPS transmission system. **avnxs** supports delayed transmissions, i.e., issuing forecasts that have been prepared by the forecaster before the transmission window opens.

Forecasts prepared by the AvnFPS forecast editor are written to the directory `xmit/pending` as text files with a particular naming convention. The filename is then used to determine the disposition of the product. Files in the `xmit/pending` directory are named as follows:

**TYPE:**        **fid-ccccnnnxxx-wmoid-wfoid-yymmddhhmm-tyt-tttttttttt**

- where
  - **fid** - Forecaster ID Number
  - **ccccnnnxxx** - AWIPS id, argument to `handleOUP.pl`
  - **wmoid** - WMO Header
  - **wfoid** - WMO ID if the WFO issuing the product
  - **yymmddhhmm** - Full Timestamp, as year (modulo 100), month (Jan=1), day of the month, UTC hour and minute
  - **tyt** - Forecast Type and Version, one of the following

\_\_\_ Routine Forecast

RRx Delayed Forecast

AAx Amendment

CCx Correction

where **x** is the version: A through Z.

- **ttttttttt** - Earliest transmission time, in Unix seconds. For routine forecasts this is the start of the transmission window or an arbitrary time set by the forecaster. For other forecasts this is the time the forecaster presses the Send button.

**avnxs** monitors files in the `xmit/pending` directory to the current system clock. The requested transmission time,  $T_{\text{xmit}}$ , and the creation time,  $T_{\text{post}}$ , are retrieved from the

filename and from the OS, respectively. If the current time  $T_{\text{cur}}$  is within range:  $T_{\text{xmit}} < T_{\text{cur}} < T_{\text{post}} + N$  hours, **avnxs** will call an AWIPS program (currently **handleOUP.pl**) to send the forecast out to the WAN.  $N$ , the number of hours before a pending file is considered 'old', is now a configurable item in `etc/xmit.cfg` file. If the forecast file is too old, it will be moved to `xmit/bad` directory. The value of  $N$  (usually 3 hours) is set in transmission server configuration file. Files that do not match transmission file format are discarded. **avnxs** checks for the return code from **handleOUP.pl**. The status is written to a file `xmit/DoW`, where *DoW* is a 3-letter abbreviation for the Day Of the Week. Here is a sample entry from `xmit/DoW`:

```
SUCCESS002-KPBZTIB072-FRUS41-KPBZ-0410270100-___-1098840000
```

The first word is either SUCCESS or FAILnnn, and nnn is the error code returned by **handleOUP.pl**. If **handleOUP.pl** fails to transmit the forecast, the file will be moved to `xmit/bad`. The transmission status will be announced via **avnserver** to all client GUIs, see Section 5, “Forecast Transmission”.

The program accepts the following arguments:

**TYPE:**           **avnxs** [-d] -n host

- where *host* is the host name where the process will run. The optional flag **-d** tells the program to not detach itself from the terminal session (i.e., to run in the foreground). See Section 9.5.3.1, “Starting AvnFPS Servers,” for an example of a **ps** listing.

The transmission server also collects information on forecasts sent by the office for verification purposes. A special product is sent periodically to the Verification Branch at NWS Headquarters that contains information that identifies which forecaster is responsible for which forecast. A configuration file `etc/xmit.cfg` specifies WMO and AWIPS headers and the frequency of transmission.

### 9.5.1.5 Client Programs

**AvnWatch** is the main client application. It provides forecast preparation and monitoring functionality. **Avnclimate** is a set of GUIs accessing archived climatological data. Current functionality provides display of historical data and statistics that can help by producing a short-term forecast based on current weather conditions.

## 9.5.2 Configuring AvnFPS

This section describes directory layout, configuration files used by AvnFPS and steps needed to download climatological data. Generally, this section will only be used as an aid in troubleshooting problems with the configuration of AvnFPS. While it is possible to configure AvnFPS by editing these files directly, most people will find it much easier to use the GUIs described in Section 9.5.4, “Avnsetup”.

After successful installation of AvnFPS 3.2, the top level directory /awips/adapt/avnfps should be as follows:

```
lx2-wfo: /bin/ls -la

drwxrwxrwx  8 fxa  fxalpha 4096 Jan  8  2010 .
drwxrwxr-x 14 awips fxalpha 4096 Sep 12  2012 ..
lrwxrwxrwx  1 fxa  fxalpha   9 Aug 29  2012 bin -> OB9.2/bin
lrwxrwxrwx  1 fxa  fxalpha   9 Aug 29  2012 etc -> OB9.2/etc
drwxrwxr-x  4 fxa  fxalpha 4096 Mar 24  2009 gamin-0.1.10
drwxrwxr-x  6 fxa  fxalpha 4096 Jan 20  2006 hdf5-1.6.4
drwxr-xr-x  9 fxa  fxalpha 4096 Dec 19  2008 OB9
drwxr-xr-x  9 fxa  fxalpha 4096 Jan  8  2010 OB9.2
drwxrwxr-x  7 fxa  fxalpha 4096 Mar 24  2009 Python-2.4.1
-rwxr-xrwx  1 fxa  fxalpha  836 Sep 25  2006 .sqlcmdlog
drwxrwxr-x  5 fxa  fxalpha 4096 Jun  9  2005 tcltk8.4.5
```

The installation process does attempt to remove versions of the software older than 3.1. It is up to you to remove any remaining cruft that might be in this directory.

All configuration files are located in the directory /awips/adapt/avnfps/3.2/etc and its subdirectories. Most of the files (those with an extension .cfg) are in Windows™ ini format:

```
[section]
keyword=argument(s)
```

Lines starting with # are comments.

Files containing specifications for graphical user GUIs follow a X11 standard:

```
*pattern: value
```

where pattern is a hierarchy of one or more widget classes/names, separated by \*. These files are located in the subdirectory app-resources.

The file etc/forecasters contains forecaster IDs and names in plain ASCII text format.

### 9.5.2.1 Files in etc

**etc/forecasters.** Contains list of forecaster ids and names/initials. The numbers must be in the range 1 through 999. Lines starting with # are comments. Blank lines are allowed in the file. The format is the same as in previous releases. An example:

```
# etc/forecasters
# List of forecasters
# Format:
# number name
1 Amanda
2 Bailing
3 Belinda
```

**etc/logging.cfg.** This file configures the logging behavior of all AvnFPS programs. You should not need to modify it. Not changed since AvnFPS 3.0.

```
# logging.cfg
```

```

# configuration file for Python logging utility

[loggers]
keys=root

[handlers]
keys=hdl

[formatters]
keys=fmt

[logger_root]1
level=NOTSET
handlers=hdl

[handler_hdl]2
class=WeeklyFileHandler
args=('s/logs' % os.environ['TOP_DIR'],
os.path.basename(sys.argv[0]).split('.')[0])
formatter=fmt

[formatter_fmt]3
format=%(asctime)s %(levelname)-5s [%(process)5d:%(thread)6d] %(module)s:
%(message)s

```

**NOTES:**

1. Log level is set in the section **[logger\_root]**. Available values in decreasing order of information output are: DEBUG or NOTSET (these two are equivalent), INFO, WARNING, ERROR, CRITICAL.
2. **[handler\_hdl]** specifies output directory and file name. The class `WeeklyFileHandler` appends an abbreviated day of the week to file name.
3. **[formatter\_fmt]** specifies format of a line written to the log file. Refer to Python Documentation for details.

**etc/server.cfg.** This file specifies values used by the data ingest servers.

```

# etc/server.cfg
# server configuration file for OB7
# last update: 03/01/06

# Name servers
# Either local or ip address. Local means that broadcast is used to locate
# the server, which means the server must be on the same subnet
# The list of tafs is displayed in the startup (menu) GUI

# Data ingest servers
[dis]1
tags=text2,ltg,rltg,file,llws,guid

#[dis_text]2
#name=text
#source=/data/fxa/point/avnfps/raw
#module=TextThread
#nhours=24

```



```

[dis_text]3
name=text
source=/awips/adapt/avnfps/data/text
module=TriggerThread
nhours=24

[dis_ltg]4
name=ltg
source=/data/fxa/point/binLightning/netcdf
module=LtgThread
# distance in miles, age in minutes
distance=20
age=15

[dis_rltg]5
name=rltg
source=/data/fxa/img/SBN/netCDF/LATLON/3hr/LTG
module=RadLtgThread

[dis_llws]6
name=llws
radar=/data/fxa/radar
profiler=/data/fxa/point/profiler/netcdf
module=LLWSThread

[dis_file]7
tag=pxl
name=file
source=/awips/adapt/avnfps/data/grids,
module=FileThread

[dis_guid]8
name=guid
ngmmos=/data/fxa/point/mos/NGM/netcdf
avmmos=/data/fxa/point/mos/AVN/netcdf
gfsmos=/data/fxa/point/mos/GFS/netcdf
etamos=/data/fxa/point/mos/ETA/netcdf
eta=/data/fxa/point/model/ETA/netcdf
module=GuidanceThread
nhours=24

# access control
# hosts allowed to access data
[valid]9
hosts=XXX.XXX.58.*

```

**NOTES:**

1. Section **[dis]** specifies which ingest threads should run. For each item tag on the list there is a corresponding **[dis\_tag]** section which defines the thread. Each section comprises several items listed below. There are two ways of accessing text products. TextThread reads data files written by **acqserver**. However, the AWIPS ingest system has to be changed from baseline configuration in order to use this thread. Thus, it is commented out and TriggerThread is used in AWIPS instead.
  - name is one of predefined data sources which is specific to each module. Do not modify this value.

- source is the directory where AWIPS data files reside. This directory is monitored by **gamin** server daemon, `gam_server`. In this case, this is the directory where **avntrigger.sh** writes files extracted from text database. A special case is LLWSThread which relies on radar and profiler data. The relevant directories are specified by keywords `radar` and `profiler`.
  - module specifies Python source code file. Do not change.
  - nhours is a module specific parameter, in this case it is the number of hours of data that should be preserved in AvnFPS database.
2. Section [**dis\_text**] defines an experimental setup that bypasses AWIPS decoders and databases. TAFs, TWEBs and METARs are retrieved from files dumped by **acqserver** into a directory. This configuration is not recommended for novices.
  3. Item [**dis\_text**] defines thread processing reports retrieved from Postgres `fxatext` by **avntrigger.sh** via the trigger mechanism. This is delivered as the default technique to get text products.
  4. [**dis\_ltg**] tag controls the processing of lightning observations. The tag distance defines an area of interest. Only lightning strikes within a square centered at the TAF site of size twice the provided value (in miles) will be extracted from AWIPS data files.
  5. [**dis\_rltg**] tag is for the radar-based 3 hour cloud-to-ground lightning probability forecast which is currently available in the lower 48 states. OCONUS sites may safely remove this tag from the list in the [`dis`]section.
  6. [**dis\_llws**] controls Low Level Wind Shear setup. The directories are the base radar file location (the site id and product type VWP will be appended by the thread). The profiler tag can be a comma-delimited list of directories. This allows LDAD directories as well as AWIPS ones to be listed.
  7. The [**dis\_file**] describes a thread that reads the content of files in the directories listed on the source line. The base directory of each file is passed to the client, which can thus determine the data type. Currently this thread reads files produced by a GFE text formatter.
  8. The [**dis\_guid**], specifies guidance data: MOS and high-resolution point NAM-WRF model data. You may comment out some lines if a particular data is not available in your area. For instance, NGM MOS isn't available in Alaska and Pacific Regions, so `ngmmos` tag can be removed.
  9. The access control section [**valid**] restricts access to AvnFPS server to hosts with IP addresses matching those on the hosts line. A shell type match characters can be used: `*` matches any string, `?` matches single character

**etc/px2finit.cfg**. This file specifies which servers should be started by `avnint` and their startup order and should not be changed.

```
# px2finit.cfg
```

```
[avnserver]1
name=avnserver
order=0
wait=5
```

```
[avndrs]
name=avndrs
order=1
wait=3
```

```
[avndis]
name=avndis
order=2
wait=1
```

```
[avnxs]
name=avnxs
order=3
```

**NOTE:**

For each server there is a separate section. The tag must be unique. A section will have the following items:

- ‘name’ specifies server name
- ‘order’ determines server startup sequence. Servers with lower order start first.
- ‘wait’ is a wait time in seconds after a particular server is started (forked), before starting the next server on the list.

**etc/gui.cfg.** Specifies the values used by GUI shared by all users.

```
# etc/gui.cfg
# specifies available monitor options for avnwatch

# Name servers
# Either local or ip address. Local means that broadcast is used to locate
# the server, which means the server must be on the same subnet
# The list of tafs is displayed in the startup (menu) GUI
[ns]
tags=local,

# colors in main GUI: 7 items
[colors]1
tags=green3,greyscale,pale green,yellow,orange,red,purple

# editor tags
[editor_tags]
fatal=red
error=orange
warning=forest green

# miscellaneous features
[features]
tafeditor=1
twbeditor=1

# viewers: taf and metar must be present, taf must be first on the list
```

```
[viewers]2
tags=taf,metar,gfsmos,etamos,ngmmos,etabuf,grids

[viewer_taf]3
module=TafViewer

[viewer_metar]
module=MetarViewer
label=Metars

[viewer_gfsmos]
module=MosViewer
label=GFS-MOS
model=gfsmos

[viewer_gfslamp]
module=MosViewer
label=GFSLAMP
model=gfslamp

[viewer_ngmmos]
module=MosViewer
label=NGM-MOS
model=ngmmos

[viewer_etamos]
module=MosViewer
label=ETA-MOS
model=etamos

[viewer_etabuf]
module=EtaViewer
label=NAM-WRF-profile

[viewer_grids]
module=GridViewer
label=Grids

[viewer_avnmos]
module=MosViewer
label=AVN-MOS
model=avnmos

[menus]4
number=7

[menu_0]5
items=metar

[menu_1]
items=persistence_1hr,persistence_2hr,persistence_3hr

[menu_2]
items=ltg

[menu_3]
items=rltg

[menu_4]
items=ccfp

[menu_5]
items=grids
```

```
[menu_6]
items=llws

[monitor_metar]6
menu=METAR
module=MetarMonitor
items=tempo,vsby,wind,wx,sky
labels=tpo,vis,wnd,wx,cig

[monitor_persistence_1hr]
menu=persistence 1hr
module=PersistMonitor
nhours=17
items=vsby,wind,wx,sky
labels=vis,wnd,wx,cig

[monitor_persistence_2hr]
menu=persistence 2hr
module=PersistMonitor
nhours=2
items=vsby,wind,wx,sky
labels=vis,wnd,wx,cig

[monitor_persistence_3hr]
menu=persistence 3hr
module=PersistMonitor
nhours=3
items=vsby,wind,wx,sky
labels=vis,wnd,wx,cig

[monitor_ltg]
menu=ltg
module=LtgMonitor
items=wx
labels=ts

[monitor_rltg]
menu=rltg
module=RadLtgMonitor
items=wx
labels=ts

[monitor_ccfp]
menu=ccfp
module=CCFPMonitor
items=wx
labels=ts

[monitor_grids]
menu=grid
module=GridMonitor
from=28
to=6
items=vsby,wind,wx,sky
labels=vis,wnd,wx,sky

[monitor_llws]
menu=llws
module=LLWSMonitor
items=wind
labels=ws
```

**NOTES:**

1. Section [colors] lists colors used to indicate discrepancies between forecasts and observations/guidance, in increasing order of severity.
2. Section [viewers] lists data viewers available in the TAF Editor window. For each tag listed, there must be a [viewer\_tag] section.
3. Each viewer requires certain parameters. Module specifies a Python source code file, label defines text displayed in the window's tab. Some modules require additional values. You should not modify any of those values, with the exception of the labels.
4. Section [menus] defines data areas in the main monitoring GUI. For each area there must be a section [menu\_#] listing items that will be monitored. Count starts from 0.
5. Items is a list of comma separated tags, each of the tags must have a corresponding [monitor\_item] section. If the list consists of one item, it must be terminated by a comma. If 2 or more items are on the list, the user can select what is monitored.
6. Each monitor requires certain parameters. module specifies a Python source code file, menu defines text displayed when the popup menu is invoked. items is a list of monitored weather elements, labels determine displayed text. To keep the GUI nicely aligned, keep label names 2 or 3 characters long.
7. "nhours" is the number of hours ahead assuming the weather does not change.
8. "from, to define" interval of time the grids are monitored against the forecast.

**etc/wxplot.cfg.** This is a configuration file for the weather plot GUI.

```
# wxplot.cfg

[print]1
cmd=convert - tmp/%s.jpg

[hours]2
back=24
forward=24

[vsby]3
bot=0.125
top=10.0

[cig]
bot=100
top=8000

[viewers]4
tags=taf,metar,gfsmos,etamos,ngmmos,eta

[selected]5
tags=taf,metar

[viewer_taf]6
```

```
module=TafPlot
label=TAF
color=blue

[viewer_metar]
module=MetarPlot
label=METARs
color=red

[viewer_gfsmos]
module=MosPlot
label=GFS-MOS
color=forest green
model=avn

[viewer_etamos]
module=MosPlot
label=ETA-MOS
color=green
model=gfs

[viewer_ngmos]
module=MosPlot
label=NGM-MOS
color=dark green
model=ngm

[viewer_eta]
module=EtaPlot
label=NAM-WRF
color=brown
```

**NOTES:**

1. Command to be executed when the Print is pressed. A window dump file (xwd format) is passed via standard input stream.
2. Number of hours of data to display, counted from the current hour.
3. Ceiling and visibility plot limits.
4. This section lists data viewers available in the Weather Plot window. For each tag listed, there must be a [viewer\_tag] section.
5. Data viewer toggles selected by default.
6. Each viewer requires certain parameters. 'module' tag specifies a Python source code file, 'label' tag defines text displayed as a toggle button name. Some modules require additional values. You should not modify any of those values, with the exception of the labels.

**etc/xmit.cfg**

This configuration files is used by **avnxs** which sends forecast and verification products out for dissemination.

```
# etc/xmit.cfg
```

```

[verification]1
wmo = NXUS98 KPIT
awips = KPBZVFTPBZ
fcstid = 0
period = 6

[transmission]2
# how often checks for new files (seconds)
frequency = 15
# reject older than (hours)
old = 3

```

**NOTES:**

1. This section defines parameters used by the program to transmit the NXUS98 verification product to NWS headquarters. wmo and awips are the WMO and AWIPS headers. These headers must exist in the file /awips/fxa/data/afos2awips.txt. The transmission file name contains (reserved) forecaster id 0. This should not be changed. The verification product is transmitted every 6 hours.
2. You may want to adjust the old value. It defines the cutoff time for early transmission.

**etc/triggerTemplate.** Made by **avnsetup**. This file is processed during trigger localization on the data server. **avnsetup** also creates a file **etc/triggerTemplate.good** while updating Postgres triggers directly. The latter is not used by the localization script.

**9.5.2.2 TAF Configuration Files**

The TAF configuration files reside in directory etc/tafs. For each TAF site CCCC there is a subdirectory etc/tafs/CCCC containing template files, one per each forecast period and site info data etc/tafs/CCCC/info.cfg.

Site Info File. This file is normally created by the Taf Site Editor GUI, normally invoked from avnsetup.

```

# etc/tafs/KPIT/info.cfg

[headers]
wmo = FTUS41 KLWX
afos = WBCTAFIAD

[thresholds]1
cig = 200,600,1000,2000,3100
vsby = 0.5,1.0,2.0,3.0,6.0
radar_cutoff = 600,0
profiler_cutoff =

[sites]2
metar = KIAD
eta = KIAD
avnmos = KIAD
ngmos = KIAD

```



```

gfsmos = KIAD
gfslamp = KIAD
radars = KLWX,KDOX
profilers =

[geography]3
lat = 38.96
runway = 60,90,
lon = -77.45
elev = 98

```

**NOTES:**

1. Section [thresholds] defines ceiling and visibility categories used by the monitoring system. A new feature of AvnFPS 3.2 is the cutoff thresholds for the VWP sources. Cutoff values correspond to heights in meters below which data will be ignored. As in the example above, for the KLWX radar, any VWP data below 600 meters will be ignored. However, all VWP data from the surface up to 2000 feet from the KDOX radar will be used. This feature is useful if your VWP source(s) is (are) routinely contaminated by non-meteorological phenomenon near the site.
2. Section [sites] defines IDs used by other data sources. Some TAF sites may have more than one associated observation. In that case, separate the ids by a comma.
3. Section [geography] provides location of the airport. elev is in meters, runway directions in degrees true north are used to calculate cross winds.

**Monitoring Rules.** The default configuration files for all monitors are located in the directory etc/tafs/XXXX. Currently these are: grids.cfg, ltg.cfg, mtrs.cfg, rltg.cfg, ccfp.cfg. All can be edited with the "Monitoring Rules" GUI via avnsetup. Here is an example of rule definition file for monitoring of METARs:

```

# etc/tafs/XXXX/mtrs.cfg

[rule_11]1
severity = 5
msg = Visibility difference of 3 or more categories
unique =
type = vsby
method = VsbyCatDelta
ncat = 3
.....
[rules]2
active = 0,1,2,3,4,5,6,7,8,9,10,11
.....
[rule_1]
severity = 3
msg = Freezing precipitation in TAF and not in obs
unique = 0
type = wx
method = WxTafDelta
wx = FZRA,FZDZ,PL

```

**NOTES:**

1. Each [rule\_N] provides arguments to the monitoring function, specified by the method keyword. The following tags must exist for each rule:
  - severity: a number in the range 1 through 5 corresponding to colors defined in gui.cfg, see 1.
  - msg: message displayed by the monitoring GUI.
  - type: one of wind, vsby, wx, sky
  - unique: 0 or 1.

Each function may accept additional arguments, such as ncat. In this case ncat is the number of categories the visibilities in a TAF/METAR pair must differ for the rule to activate. Thus you may specify the same method with different arguments, ncat=2 in our case.

2. Section [rules] defines the list of rules to monitor. For each number there must be a corresponding [rule\_N] section.

If you want to have rules dependent on the TAF site, copy the relevant file to the TAF site directory and modify it there. The monitoring program first tries to find the files in the site directory, if it can't find it there, uses the one from etc/tafs/XXXX.

**Important!** There are no default hardcoded rules. The files in etc/tafs/XXXX must exist.

**Impact QC Definition File.** Impact QC is a new feature in AvnFPS3.2. The forecaster can be alerted when a prepared TAF has a significant impact on airport operations. This file is optional. Currently this file cannot be modified with avnsetup, you must use a text editor instead. Shown below is a configuration file with additional rules added that are specific to Pittsburgh International Airport, etc/tafs/KPIT/impact.cfg:

```
# impact.cfg

[conditions]1
items=cond_1,cond_2,cond_3,cond_4,cond_5

[cond_1]2
tag=FC
level=1
text=Impact: Fuel-Alternate vsby<3 or cig<2000
expr=vsby<2.95 or cig<2000

[cond_2]
tag=FC
level=2
text=Impact: LIFR conditions vsby<1 or cig<500
expr=vsby<0.95 or cig<500

[cond_3]
tag=ws
level=1
text=Wind shift vs previous group resulting in >6kt change along PIT runway
28R/10L,may affect runway config
expr=wind[0].shift and wind[0].runway>6
```

```
[cond_4]
tag=xw
level=1
text=Cross wind component >14KT on PIT runway 28R/10L
expr=wind[0].cross>14

[cond_5]
tag=xw
level=2
text=Cross wind component >24KT on PIT runway 28R/10L
expr=wind[0].cross>24
```

**NOTES:**

1. Section [conditions] defines the list of conditions to check. For each tag [cond\_N] there must be a corresponding section.
2. Each [cond\_N] provides arguments to the impact check function. The check is done for each TAF period. The following tags must exist for each rule:
  - **expr:** A Python expression to be evaluated. This expression can contain following variables: vsby, cig and wind. vsby is in miles, ceiling in feet. wind is an array that has length equal to the number of runways. Each element of this array contains 3 values: runway, cross and shift. The wind vector is represented in a Cartesian coordinates along and perpendicular to the runway. The absolute values of these components are wind[N].runway and wind[N].cross, where N is runway number, counted from 0, as listed in the site configuration file, see section: : “Site Info File”. wind[N].shift is a Boolean value, indicating that the runway component changed sign from one TAF period to another.
  - **text:** Message to be displayed when the expression evaluates to True.
  - **level:** Highlight background color, 1 - green, 2 - orange.
  - **tag:** Used to group messages, so only the message with the highest level is displayed. In this example, if visibility is 1/2SM, only the LIFR message is shown in a popup window of the TAF Editor.

**Climate QC Definition File.** The file etc/tafs/XXXX/climqc.cfg is used to define category thresholds used while creating climate QC count files. Currently this file cannot be modified with **avnsetup**, you must use a text editor. An example:

```
#etc/tafs/XXXX/climqc.cfg

[args]1
alpha=0.3
showdetails=0

[thresholds]2
vsby=0.27,1.1,2.9,6.1
cig=205,605,1005,3105,40000
ff=4.1,10.1,20.1
dd=22.5,67.5,112.5,157.5,202.5,247.5,292.5,337.5
```

**NOTES:**

1. The parameter alpha is used to determine likelihood of occurrence of a combination of weather elements in the forecast based on conditional probabilities. Alpha should be a positive number, less than one. The showdetails flag (0=no;1=yes) turns detailed statistics display, generally disliked by forecasters.
2. The thresholds determine category ranges. Each of arguments is a list of values  $v_1 < v_2 < \dots < v_n$ , with implicit  $v_1 = 0$  and  $v_{n+1} = \infty$ . Category k consists of all values  $v$  such that  $v_k \leq v < v_{k+1}$ .

The value 40 000 ft on the ceiling list serves to distinguish between limited and unlimited ceiling, which is coded as 99 998 ft.

If you want to have thresholds dependent on the TAF site, copy the file to the TAF site directory and modify it there. The program avnqcstats which creates the count files first tries to find the file in the site directory, if it can't find it there, uses the one from etc/tafs/XXXX.

**TAF Product Definition Files.** Located in etc/tafs. Normally created by the Taf Product GUI invoked from avnsetup. An example file:

```
# etc/tafs/PBZ_TAFS.cfg

# list of TAF sites
[sites]
workpil = PITWRKTAF
idents=KPIT,KAGC,KBVI,KLBE,KHLG,KMGW,KZZV,KFKL,KDUJ
```

**Default Product File.** The optional DEFAULT file contains name of the configuration file, sans the .cfg extension. That should be loaded on startup of the monitoring GUI. If not present, the first one in alphabetical order is used.

**TAF Formatter Configuration Files.** The TAF Formatter requires three configuration files. These files are located in the directory etc/tafs/XXXX. With AvnFPS3.2, flt\_cat.cfg and grp\_taf.cfg files can now be customized for each TAF site and moved to its respective etc/taf/CCCC directory.

File flt\_cat.cfg contains the threshold values of visibility and ceiling height that are used to determine aviation flight categories. The default values are identical to those provided in Directive 10-813. The thresholds can be changed to site-specific values.

```
#etc/tafs/XXXX/flt_cat.cfg
[cig]
thresholds=200,500,1000,3000,3500,4000,5000,8000,10000,12000,15000,18000,20000
[vis]
thresholds=0.5,1,3,51
```

**NOTE:**

1. These thresholds divide the spectrum of ceiling and visibility into categories with an implied 0 at the beginning and 'infinity' at the end of each list. Thus as defined here, ceiling category 1 corresponds to cloud heights from 0 to 200 feet, category 2 from 200 to 500 feet, etc. Similarly for visibility, with category 1 corresponding to visibilities LTE to 1/2 mile. Category 5 corresponds to visibility greater than 5 miles.

File `grp_taf.cfg` contains the configurable threshold values that are used to form concise TAFs. Detailed description for each category has been provided inside the file.

```
#
# This file contains thresholds that control the algorithm that converts
# numerical/tabular guidance into 'guidance' TAFs.
#
# Probabilities (POT and POP06) above which precipitation and/or
# thunderstorms will be included in the prevailing group.
#
[prev]
pop=80
tstm=80
#
# Probabilities (POT and POP06) above which the tempo group is formed
# containing precipitation and/or thunderstorms.
#
[tempo]
tstm=36
pop=36
#
# Boolean (yes/no) if PROB30 groups are wanted in guidance TAFs
[prob30]
value=yes
#
# The longest time span in hours that makes this group combinable with
# a longer, adjacent (in time) group. If the duration of a group is longer
# than this value, this group stays alone in the TAF.
#
[short_dt]
value=11
#
# The shortest time span in hours that allows its shorter duration
# neighbor to be combined with it.
#
[long_dt]2
value=15
#
# Maximum category difference between the long and the short duration groups.
# If the
# difference in flight category between the two groups is greater than this
# value,
# they are not combined.
#
# Categories are treated separately for visibility and ceilings.
#
# To see the breakpoints for the ceiling and visibility categories, see
# etc/tafs/XXXX/flt_cat.cfg (flight category) configuration file.
#
```

```

# First the visibility
#
[dc_vis]3
value=1
#
# Lowest visibility category to which the combining algorithm is applied
#
[low_c_vis]4
value=5
#
# Highest visibility category to which the combining algorithm is applied
#
[high_c_vis]5
value=5
#
# Now, the ceiling . . .
#
[dc_cig]6
value=1
#
# The lowest ceiling category to which the combining is applied
#
[low_c_cig]7
value=13
#
# Highest ceiling category to which the combining is applied
[high_c_cig]8
value=14
#
# Earliest forecast time in hrs to which the combining algorithm can be
applied
[low_p]9
value=12
#
# Maximum allowable ceiling height in hundreds of feet when thunderstorms
# are forecasted
#
[cb_hi]
value=50
#
# Maximum speed which is considered to be not a calm wind.
[wind]
calmwd=5
#
# Wind speed and direction change in wind speed above which combining will not
be applied.
value=10
delta=410

```

**NOTES:**

Items 1 through 9 control how two dissimilar (in visibility and/or ceiling) groups, one 'short', the other 'long', can be further combined.

1. The maximum duration of the smaller group that can be combined with the larger, dissimilar one. When combined, the larger group values are not adjusted by the smaller group's values.

2. The minimum length of time to be considered the 'large' group candidate for combining with smaller ones.
3. The largest visibility category difference allowed between TAF groups and still be able to combine.
4. The lowest visibility category allowed to be considered for combining. This value is related to the values assigned to the vis thresholds in flt\_cat.cfg file.
5. The highest visibility category allowed to be considered for combining. This value is related to the values assigned to the vis thresholds in flt\_cat.cfg file. Usually set to the number of visibility 'breakpoints' in vis thresholds.
6. The largest ceiling category difference allowed between TAF groups and still be able to combine.
7. The lowest ceiling category allowed to be considered for combining. This value is related to the values assigned to the cig thresholds in flt\_cat.cfg file.
8. The highest ceiling category allowed to be considered for combining. This value is related to the values assigned to the cig thresholds in flt\_cat.cfg file. Usually set to the number of ceiling 'breakpoints' in cig thresholds.
9. Number of hours when the combining algorithm will be applied to groups valid beyond the TAF's beginning valid time.
10. Maximum allowable difference in speed (knots) and direction (tens of degrees) between groups allowed to be combined.

Finally, grid\_probs.cfg contains configuration data on how the probability attributes on IFPS grids are translated into numerical probability values that will be used to form TAFs. Remember that precipitation is only included in the TAFs when certain probability threshold is exceeded. This file cannot be customized to individual TAF sites.

```
#tables used to convert prob symbols in grids to a pop value
[before9hr]
S=30
IS=30
WS=30

SC=50
O=50
C=50

D=70
WP=70
NM=70
L=70

[after9hr]
S=20
IS=20
WS=20

SC=30
O=30
C=30
```

```
D=50
WP=50
NM=50
L=50
```

### 9.5.2.3 *TWEB Configuration Files*

The TWEB configuration files reside in etc/twbs.

#### **Route Configuration Files**

For each TWEB route or synopsis there is a subdirectory etc/twbs/NNN containing template file route/synopsis info data etc/twbs/NNN/info.cfg. This file is normally created by the setup program avnsetup. An example file:

```
# etc/twbs/073/info.cfg
[headers]
wmo = FRUS41 KPBZ
afos = PITTWB073

[sites]
metars = KCLE,KYNG,KPIT,KLBE,KJST,KAOO,KMDT,KMRB,KDCA
tafs = KCLE,KYNG,KPIT,KLBE,KJST,KAOO,KMDT,KMRB,KDCA
```

Section [sites] lists TAFs and METARs that should be displayed in the TWEB Editor window.

**TWEB Product Configuration Files.** These files are located in etc/twbs. They are normally created by avnsetup. An example file:

```
# etc/twbs/PIT_TWEBS.cfg

[sites]
workpil = PITWRKTWB
idents = 072,073
```

**Default Product File.** The optional DEFAULT file contains name of the product that should appear selected in the product loader in the TWEB Editor window. If not present, the first product in alphabetical order is chosen.

### 9.5.2.4 *X Resources Configuration Files*

The default and individual resource files are located in the directory etc/app-resources. To edit the default file etc/app-resources/X you can use any text editor. Individual files have naming convention X.N, where N is the forecaster number from etc/forecasters. These files are created by a graphical editor available from the AvnWatch GUI menu.

Here is the listing of the default file etc/app-resources/X.

```
!! default X resources configuration file
!! last modified July 10, 2005
!! user editable options
```



```

!! default font
!! change 100 to 140 if you want bigger default font
*font:                                -adobe-helvetica-bold-r-normal-*-*-*100-*-*-*p-
*-iso8859-9
!! default colors
*background:                          grey70
*foreground:                           black
!! text window font
*Text.font:                            7x14
!! text window colors
*Text.background:                      #2f3f6f
*Text.foreground:                      #ffffff
!! other text window specific options
*Text.width:                           74
*Text.height:                          24
*Text.cursor:                          hand1
!! forecast editor font - may want bigger
*textEditor.font:                      8x16
!! forecast editor colors - may want different
*textEditor.background:                #1f2f6f
*textEditor.foreground:                white
*textEditor.width:                     70
*textEditor.height:                    12
!! cursor width and color
*textEditor.cursor:                    arrow
*textEditor.insertWidth:                5
*insertBackground:                     yellow
!! text viewer window options
*textViewer.width:                      74
*textViewer.height:                     12
!! forecast editor orientation: horizontal or vertical
*orientation:                          vertical
!! listbox font
*Listbox.font:                          7x14
!! entry font
*Entry.font:                            7x14
!! entry window colors
*Entry.background:                     white
*MessageBar*Entry.background:          grey85
!! balloon message (popup) font
*Balloon.Label.font:                   7x14
!! modifies behavior of dialogs
*transientDialogs:                     1
!! confirmation on closing editor
*confirmClose:                          0
!! confirmation on sending amendments/corrections
*confirmSend:                           1
!! alert options: use colors for the first level that should result in
!! notification - pale green, yellow, orange, red, purple or none
*notifyDeiconify:                       yellow
*notifyRaise:                           red
*notifyPlay:                             pale green
!! not implemented
!!*notifyTalk:                          none
*playFile:                              /awips/fxa/data/sounds/asterisk.au
!! blink on new notification
*blink:                                  1
!! warning/error level to disallow send:
!! 'always', 'warning', 'error', 'fatal'
*disallowSend:                          error
!! forecast editor options

```

```

!! use template, one of: template, merge, latest
*loadOrder:                merge
!! ask for transmission time when sending routine forecasts
*asktime:                   1
!! periodically save bulletins in a backup file
*autosave:                  1
!! update issue and valid times on QC
*updatetimes:              1
!! print forecasts on send
*autoprint:                 0
!! Insert/Overwrite
*insert:                    1
!! Word-wrap long lines: either none or word
*wrap:                      word
!! Amd, Rtd, Cor buttons on the right
*amdbuttons:               1
!! number of TAFs to display
*numTafs:                   1
!! number of hours of METARs to display
*numHours:                  6
!! show bulletin headers in the text window
*showHeaders:              1
!! show decoded METARs
*showDecoded:              1
!! show category probabilities for MOS
*showProbs:                 1
!! Format of MOS and Grids reports: raw, long or short
*showFormatted:            short
!! flight category highlights
*highlightFlightCat:       0
*lifrColor:                 #6c1916
*ifrColor:                  #5b3c2c
*mvfrColor:                 #2c484c
*vfrColor:                  #112346
!!
!! editable by knowledgeable people only
!!
!! send forecasts in a collective
*collective:                0
!! prevents line wrap in message boxes
*wrapLength:                0

```

## NOTES:

1. Lines starting with "!!" are comments. Resource names begin with a "\*" and end with ":". Anything after a ":" is a resource value. Many of the allowable values are not well documented, or cryptic. For example, valid values for cursor shape in a text window

```
*Text.cursor:                hand1
```

are defined in file `/usr/include/X11/cursorfont.h`. You have to know that the leading `XC_` in the following line:

```
#define XC_hand1 58
```

must be stripped and 58 ignored. Valid color names are in `/usr/lib/X11/rgb.txt`, but if you don't find one you like, a hexadecimal number can be used instead, such as the following:

```
*lifrColor: #6c1916
```

We suggest that you use the graphical resource editor available from in **avnsetup** before making changes to this file.

2. Climate applications introduced in AvnFPS 3.2 have their own resource files: XWindRose, XCigVisTrend and XCVMonthly. These are not user-specific.

### 9.5.2.5 *Climatological Data*

AvnFPS 3.2 introduces a new set of climatological GUIs requiring updated climatological files. The GUIs require fast, efficient access to voluminous amounts (often 30 years) of data. The existing NetCDF, delivered with AvnFPS 3.1 was determined too slow and inefficient when GUI response times needed to be in seconds. HDF5 is a file format that emphasizes storage and I/O efficiency to meet performance requirements. The AvnFPS team decided to use this format for its new climatology GUIs.

The climatological data files for all locations where the NWS prepares TAFs have been posted to a web page that is available to the World Wide Web. The Universal Resource Locator (URL) for the directory where they are posted is <http://www.mdl.nws.noaa.gov/~avnfps/data/hdf5>. File names are of the form CCCC.hdf5, where CCCC is the location identifier where the data were observed. The files are rather large but HDF5 already stores the data in compressed format, so there is no post-processing step after downloading it. The files are ready to be used at this point by the new climatological GUIs.

Although some WFOs may find this hosting solution awkward, it seemed to be the safest way to protect the AWIPS WAN from the impacts of large data transfers.

The following procedures can be used to download the data files and make them available to AvnFPS.

#### ► **To Download From an Internet Browser**

1. On a host that can access the WWW, launch a browser application and direct it to <http://www.mdl.nws.noaa.gov/~avnfps/data/hdf5>. You will see a page that lists available stations along with file modification times and sizes. The link for each station points to a binary file.
2. Find the station whose data you want to download.
3. Use the appropriate browser features to download the file for the station your site needs. On most browsers, this involves performing a right click on the station name and a feature such as **Save Link Target As...** or **Save Link As**.
4. Move this file to AvnFPS climate directory /data/adapt/avnfps/climate. Files can be moved physically via removable media, transferred through the AWIPSPUB firewall, or transferred via LDAD.

5. Once the save process is completed you may proceed for other stations using the same procedure.

► **To download using wget command on a Linux host**

1. Identify the URLs for each file you will download. They are of the form **http://www.mdl.nws.noaa.gov/~avnfps/data/hdf5/CCCC.hdf5**, where CCCC is the Station ID.
2. Identify a directory on your local system where the files can reside temporarily.
3. Use the wget to download each file.
 

```
wget --passive-ftp -nv dataURL -o output_dir/CCCC.hdf5
```

  - where dataURL is the URL from the previous step, CCCC is the site id you and output\_dir is the directory where you want to save the files.
4. Move these files to AvnFPS data directory /data/adapt/avnfps/climate. This directory is visible from all hosts. Files can be moved physically via removable media, transferred through the AWIPSPUB firewall, or transferred via LDAD.

### 9.5.3 Starting and Stopping AvnFPS

All AvnFPS processes, servers, clients and utilities are started by the **avnstart.sh** shell script. This script is responsible for setting the appropriate environmental variables required by AvnFPS. The variables are actually set in the file **bin/avnenv.sh** which is sourced by **avnstart.sh**. The first argument is process name (a Python script residing in the directory **/awips/adapt/avnfps/3.1/py** without the extension **.py**). Remaining arguments, if any, are passed to the process without modification.

► **To start avnsetup from the command line, from your individual user account:**

```
TYPE: /awips/adapt/avnfps/bin/avnstart.sh avnsetup
```

► **To start avnmenu from the command line, enter:**

```
TYPE: /awips/adapt/avnfps/bin/avnstart.sh avnmenu
```

#### 9.5.3.1 Starting AvnFPS Servers

AvnFPS requires four servers. They are:

**avnserver** Which helps client processes find the services they need (name service) and notifies clients when data are available (event service).

- avndis**      The Data Ingest Server, copies data from various AWIPS sources into the AvnFPS directory tree, reformatting as needed.
- avndrs**      The Data Request Server, answers requests for data from client processes.
- avnxs**        The Forecast Transmission Server, manages transmit queues and the interface to the AWIPS software that transmits products.

The way these servers work together requires some rules.

- The order in which the servers start is important; **avnserver** must be started first.
- There can be only one instance of **avnserver** within WFO subnet; running it on both PX1 and PX2 will lead to unexpected results.
- The **avndis** depends on **avndrs** to process Low Level Wind Shear data.
- The simplest way to avoid these problems is to not launch these servers directly. The application **avninit** searches for active instances of all four AvnFPS servers and launches the ones that are not running. This application is modeled on the UNIX SYSV **init** and the AWIPS DataControllers. Like **init** and the DataControllers, **avninit** is a persistent process.

#### NOTES:

**avninit** will attempt to restart a failed server only 10 times within an hour. When the number of restarts exceeds 10 attempts, then **avninit** must be manually restarted.

**avninit** is invoked by the AWIPS startup scripts **px2apps** and **px2apps** together with other AWIPS applications. If you have to start the servers afterwards, use the **remoteServers.sh** shell script. This script accepts the following command line arguments:

```
/awips/adapt/avnfps/bin/remoteServers.sh [start|stop|restart]
```

This script has to be run as user **fxa**. It uses **ssh** to start/stop **avninit** on **PX2**. Therefore it can be run from any workstation. It is located in the directory **/awips/adapt/avnfps/bin**.

Example usage:

```
TYPE:            /awips/adapt/avnfps/bin/remoteServers.sh start
```

- **To list avnfps processes use the ps command. As your individual user:**

```
TYPE:            ps -efw | grep avnpython
```

- Using PX2 as an example, you should see output similar to the following:

```
fxa 11280 1 11280 0 1 Mar 01 ? 00:00:00 avnpython /awips/adapt/avnfps/3.2/py/avninit.py px2f
fxa 11498 11280 11498 0 10 Mar 01 ? 00:00:00 avnpython /awips/adapt/avnfps/3.2/py/avnserver.py -d -n px2f
fxa 11500 11280 11500 0 4 Mar 01 ? 00:00:00 avnpython /awips/adapt/avnfps/3.2/py/avndrs.py -d -n px2f
```

```
fxa 11508 11280 11508 0 10 Mar 01 ? 00:00:00 avnpython /awips/adapt/avnfps/3.2/py/avnidis.py -d -n px2f
fxa 11509 11280 11509 0 1 Mar 01 ? 00:00:10 avnpython /awips/adapt/avnfps/3.2/py/avnxs.py -d -n px2f
```

- **To see all the threads in hierarchical format, add `-L` option to `ps`. Using `PX2` as an example, as your individual user:**

**TYPE:**

`ps -efL | grep avnpython`

- Using `PX2` as an example, you should see output similar to the following:

```
fxa 11280 1 11280 0 1 Mar 01 ? 00:00:00 avnpython /awips/adapt/avnfps/3.2/py/avninit.py px2f
fxa 11498 11280 11498 0 10 Mar 01 ? 00:00:00 avnpython /awips/adapt/avnfps/3.2/py/avnserver.py -d -n px2f
fxa 11498 11280 11499 0 10 Mar 01 ? 00:00:00 avnpython /awips/adapt/avnfps/3.2/py/avnserver.py -d -n px2f
fxa 11498 11280 11501 0 10 Mar 01 ? 00:00:00 avnpython /awips/adapt/avnfps/3.2/py/avnserver.py -d -n px2f
fxa 11498 11280 11502 0 10 Mar 01 ? 00:00:00 avnpython /awips/adapt/avnfps/3.2/py/avnserver.py -d -n px2f
fxa 11498 11280 11507 0 10 Mar 01 ? 00:00:03 avnpython /awips/adapt/avnfps/3.2/py/avnserver.py -d -n px2f
fxa 11498 11280 11515 0 10 Mar 01 ? 00:00:04 avnpython /awips/adapt/avnfps/3.2/py/avnserver.py -d -n px2f
fxa 11498 11280 11518 0 10 Mar 01 ? 00:00:10 avnpython /awips/adapt/avnfps/3.2/py/avnserver.py -d -n px2f
fxa 11498 11280 11519 0 10 Mar 01 ? 00:00:00 avnpython /awips/adapt/avnfps/3.2/py/avnserver.py -d -n px2f
fxa 11498 11280 11521 0 10 Mar 01 ? 00:00:40 avnpython /awips/adapt/avnfps/3.2/py/avnserver.py -d -n px2f
fxa 11498 11280 11523 0 10 Mar 01 ? 00:00:18 avnpython /awips/adapt/avnfps/3.2/py/avnserver.py -d -n px2f
fxa 11500 11280 11500 0 4 Mar 01 ? 00:00:00 avnpython /awips/adapt/avnfps/3.2/py/avndrs.py -d -n px2f
fxa 11500 11280 11504 0 4 Mar 01 ? 00:00:00 avnpython /awips/adapt/avnfps/3.2/py/avndrs.py -d -n px2f
fxa 11500 11280 11505 0 4 Mar 01 ? 00:00:00 avnpython /awips/adapt/avnfps/3.2/py/avndrs.py -d -n px2f
fxa 11500 11280 11524 0 4 Mar 01 ? 00:00:01 avnpython /awips/adapt/avnfps/3.2/py/avndrs.py -d -n px2f
fxa 11508 11280 11508 0 10 Mar 01 ? 00:00:00 avnpython /awips/adapt/avnfps/3.2/py/avnidis.py -d -n px2f
fxa 11508 11280 11511 0 10 Mar 01 ? 00:00:13 avnpython /awips/adapt/avnfps/3.2/py/avnidis.py -d -n px2f
fxa 11508 11280 11512 0 10 Mar 01 ? 00:00:15 avnpython /awips/adapt/avnfps/3.2/py/avnidis.py -d -n px2f
fxa 11508 11280 11513 0 10 Mar 01 ? 00:01:41 avnpython /awips/adapt/avnfps/3.2/py/avnidis.py -d -n px2f
fxa 11508 11280 11516 0 10 Mar 01 ? 00:00:02 avnpython /awips/adapt/avnfps/3.2/py/avnidis.py -d -n px2f
fxa 11508 11280 11517 0 10 Mar 01 ? 00:00:01 avnpython /awips/adapt/avnfps/3.2/py/avnidis.py -d -n px2f
fxa 11508 11280 11520 0 10 Mar 01 ? 00:00:00 avnpython /awips/adapt/avnfps/3.2/py/avnidis.py -d -n px2f
fxa 11508 11280 11526 0 10 Mar 01 ? 00:00:11 avnpython /awips/adapt/avnfps/3.2/py/avnidis.py -d -n px2f
fxa 11508 11280 11527 0 10 Mar 01 ? 00:00:43 avnpython /awips/adapt/avnfps/3.2/py/avnidis.py -d -n px2f
fxa 11508 11280 11532 0 10 Mar 01 ? 00:00:15 avnpython /awips/adapt/avnfps/3.2/py/avnidis.py -d -n px2f
fxa 11509 11280 11509 0 1 Mar 01 ? 00:00:10 avnpython /awips/adapt/avnfps/3.2/py/avnxs.py -d -n px2f
```

**NOTE:** Red Hat Enterprise 4™ threads are listed differently by `ps`. The `-H` (process hierarchy) option cannot be used with the thread (`m`, `L` or `T`) request.

### 9.5.3.2 Stopping AvnFPS Servers

- **To stop the AvnFPS servers, as user `fxa`, run the following command from your workstation:**

**TYPE:** `/awips/adapt/avnfps/bin/remoteServers.sh stop`

As an alternative option for stopping the AvnFPS servers, you can log on to the host(s) where the AvnFPS servers run and use the `avnkill` command located in `/awips/adapt/avnfps/bin`. The `avnkill` command first issues a **SIGTERM** signal and then waits 30 seconds for all threads to terminate gracefully. If the threads do not exit, `avnkill` issues a **SIGKILL** signal to those processes that continue to run.

Yet another option is to send a **SIGTERM** signal to `avninit`. For the sample listing above, as user `fxa` on `PX2`, the command would be: **kill 30926**

This should stop all the servers because `avninit` sends **SIGTERM** to all its child processes before quitting.

**NOTE:** When **avninit** starts, all the existing AvnFPS server processes are stopped.

Under special circumstances, (e.g., a hung server), you may want to stop and start a single AvnFPS server. Since **avninit** monitors them and starts those which are not running, you only need to kill the hung process. Bear in mind that the AvnFPS servers are threaded and only the top-level thread accepts signals.

For the **ps** listing above, the hierarchy is represented by order. For instance:

- ▶ **To restart the avndrs server, find the first occurrence of avndrs in the output above, and type:**

**TYPE:** `kill 11500`

- Result: Process 11500 and its threads are terminated. Once the **avndrs** server exits, **avninit** will try to start a new **avndrs** server instance.

#### 9.5.4 Avnsetup

The **avnsetup** is a GUI that can be used to configure most of the features of AvnFPS. Exhibit 9.5.4-1 shows the **avnsetup** main GUI.



**Exhibit 9.5.4-1. avnsetup Main GUI**

This section describes tasks that can be accomplished with this program.

**Important!** The AvnWatch GUI must be restarted in order for changes made using the following setup GUIs (except the Trigger Editor) to take effect. The reason for this is that the underlying files are read once into memory on startup.

### 9.5.4.1 Editing Monitoring Rules

From the **avnsetup** main GUI, select the **Monitoring Rules** button to launch the Monitoring Criteria Editor (Exhibit 9.5.4.1-1).

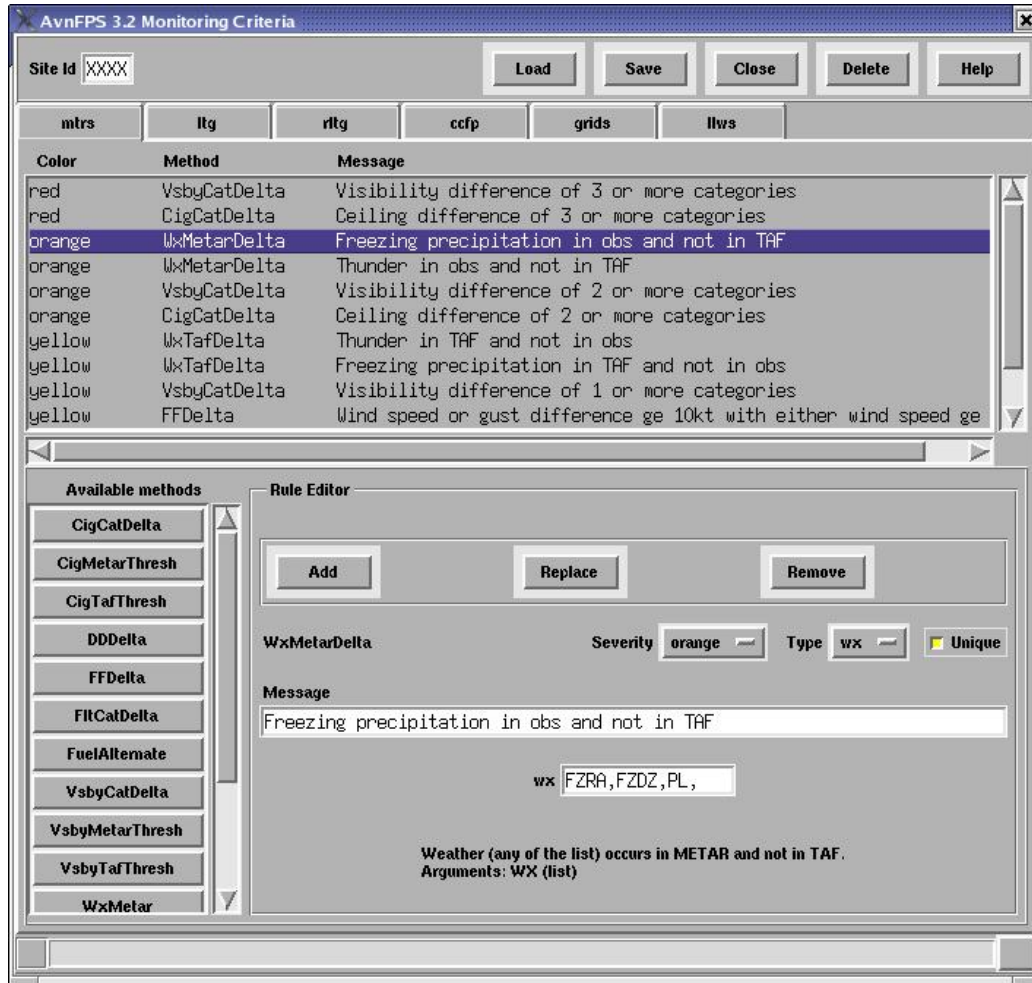

Exhibit 9.5.4.1-1. AvnFPS Monitoring Criteria Editor

The Monitoring Criteria Editor contains several pages, one for each monitored data source. Pages are selected via “recipe tabs” near the top of the menu. The tab labels refer to the following data sources:

- Rules for monitoring METAR observations (**mtrs**)
- Rules for monitoring lightning observations (**ltg**)
- Rules for monitoring lightning nowcasts (**rltg**)
- Rules for monitoring Collaborative Convective Forecast Product (**ccfp**)
- Rules for monitoring forecast grids (**grids**)
- Rules for monitoring low level wind shear (**llws**).



Each page has an identical layout. The top part lists currently defined rules, the bottom part contains a list of all available methods and the area where you can view, modify, add or delete a rule.

AvnFPS supports site-specific monitoring rules as well as a set of default rules. When the rule editor is started, the default rules are loaded. This is indicated by XXXX in the **Site Id** entry field.

- ▶ **To load the default set of rules**
  1. Enter 'XXXX' into the box labeled **Site Id**.
  2. Press **Enter** or select the **Load** button.
  
- ▶ **To load the specific rules for a site**
  1. Enter the Station ID into the box labeled **Site Id**.
  2. Press **Enter** or select the **Load** button.
  
- ▶ **To create a new set of site-specific rules**
  1. Modify the rules using the instructions below.
  2. Enter the applicable Station ID into the box labeled **Site Id**.
  3. Select the **Save** button.
  
- ▶ **To remove site-specific rules**
  1. Enter the Station ID into the box labeled **Site Id**.
  2. Select the "recipe tab" for the data source for which you want to remove the rules.
  3. Select the **Delete** button.

The lower half of the Monitoring Criteria Editor allows you to view and modify each of the monitoring rules. The current set of rules is listed by color and message in a selectable list. The **Rule Editor** at the bottom of the menu shows details of the rule that is currently selected. To the left to the Rule Editor is a list of **Available methods**. These methods are software techniques that compare the current forecast to the latest values received from the data source. Each method has its own set of arguments that configure its behavior.

- ▶ **To view the details of an existing rule**
  1. Select the rule from the list.
  
- ▶ **To modify an existing rule**
  1. Select the rule you want to modify from the list.
  2. Use the **Rule Editor** to make the necessary changes.

3. Select **Replace**.
4. Select **Save** to write changes to the configuration file.

▶ **To remove a rule**

1. Select the rule you want to remove from the list.
2. Select **Remove**.
3. Select **Save** to write changes to the configuration file.

▶ **To add a new rule**

1. Select a method from the “Available Methods” list. The **Rule Editor** will update with the appropriate fields. You can see method details by pointing the cursor to the respective button on the list.
2. Use the **Rule Editor** to **Modify** arguments as needed. You must enter a message.
3. Select **Add**.
4. Select **Save** to write changes to the configuration file.

**NOTE:** Changes made in the Monitoring Criteria Editor will not affect the TAF Monitor until it is restarted.

#### 9.5.4.2 *Editing AvnFPS TAF Site Information*

From the **avnsetup** main GUI, select the **TAF SiteInfo** button to display the TAF Site Info Editor, as shown in Exhibit 9.5.4.2-1. The fields in the editor are described in Table 9.5.4.2-1.

Exhibit 9.5.4.2-1. AvnFPS TAF Site Info Editor

Table 9.5.4.2-1. AvnFPS TAF Site Info Editor Fields and Descriptions

Site Id	TAF Site ID
TAF WMO	WMO header used to transmit forecast
TAF AFOS	PIL used during transmission
XTF WMO	WMO header used to transmit extended forecast (experimental)
XTF AFOS	PIL used during transmission
Visibility	A comma-separated list of visibilities in miles that define the categories used by the monitoring modules. Given the list $0 < V_1 < V_2 < \dots < V_n$ , the category <b>k</b> consists of visibilities <b>V</b> such that $V_{k-1} \leq V < V_k, k = 1, \dots, n+1$ and $V_0 = 0, V_{n+1} = \infty$
Ceiling	A comma-separated list of ceilings, in feet, defining the categories used by the monitoring modules. These categories are defined in the same way as visibilities, shown above.
Radar Cutoff	A comma separated list of heights in meters defining lowest height to be used in computing LLWS using this radar. The length of the cutoff list must be equal to the number of radars listed in the 'Radar' text field below.
Profiler Cutoff	A comma separated list of heights in meters defining lowest height to be used in computing LLWS using this profiler. The length of list must be equal to the number of profilers listed in the 'Profiler' text field below.
Latitude	Site latitude, in degrees north
Longitude	Site longitude, in degrees east
Elevation	Site elevation, in meters

Site Id	TAF Site ID
Runway(s)	A comma-separated list of runway directions in degrees. Used to calculate crosswind.
METAR	The METAR site ID associated with the TAF, most likely the same as TAF. If more than one site is needed, separate entries by a comma.
ETA	The closest site ID found in ETA BUFR message associated with the TAF.
NGMMOS	The closest site ID found in NGM MOS message associated with the TAF.
AVNMOS	The closest site ID found in AVN MOS message associated with the TAF.
ETAMOS	The closest site id found in ETA MOS message associated with the TAF.
GFSLAMP	The closest site id found in LAMP message associated with the TAF. This list is not yet available.
Radars	A comma-separated list of radars associated with the TAF. This list can be empty.
Profilers	A comma-separated list of profilers associated with the TAF. This list can be empty.

► **To add TAF site data**

1. Enter the Station ID into the box labeled **Site Id**.
2. Select the **Update** button. Most of the fields will be filled in. Headers are read from the **afos2awips.txt** file. Latitude, longitude and elevation come from the **metarStationInfo.txt** file. Other values are built-in defaults.
3. Modify displayed entries as needed. Only the **METAR** entry is mandatory, all of the others are optional. A simple validation test is performed when you type. The program will not allow you to enter obviously incorrect values. Incomplete values are indicated by a pink background.
4. Select the **Save** button.
5. Create templates as described in the next section.

► **To modify TAF site data**

1. Enter the Station ID into the box labeled **Site Id**.
2. Select the **Load** button.
3. Modify the displayed entries as needed.
4. Select the **Save** button.

### 9.5.4.3 *Editing AvnFPS TAF Site Templates*

The bottom part of TAF Site Editor provides tools to create and edit template files that can be used to initialize forecasts. There is a separate template for each forecast issue time to allow users to enter issue specific phrases such as AMD NOT SKED AFT....

► **To create TAF templates**

1. Enter the Station ID into the box labeled **Site Id**.

2. Select the **Make** button. This will create all four templates containing Station ID, issue and valid times. For example, a 06Z template for KPIT would be KPIT DD0520Z DD0606 =

► **To modify TAF template**

1. Enter the Station ID into the box labeled **Site Id**.
2. Select issue time from **Issue** menu and press the **Edit** to invoke a text editor. *Do not* press the **Make** button, as this will overwrite your current templates.

#### 9.5.4.4 Editing AvnFPS TAF Product Definition

From the **avnsetup** main GUI, select **TAF Products** button. TAF Product Configuration Editor will display (see Exhibit 9.5.4.4-1).

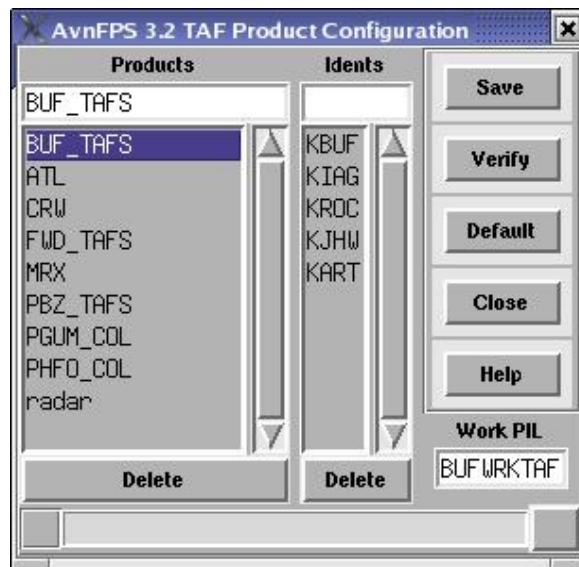

Exhibit 9.5.4.4-1. AvnFPS TAF Product Configuration Editor

The existing products will be displayed in alphabetical order, with the default (if defined) on the top of the list. The **Idents** window displays list of all TAF sites in the product.

► **To add a product**

1. Type the product name in the text window under the **Products** label and press **Enter**. An error message will be displayed that the product cannot be loaded, this is OK.
2. Enter Site ID in the window under the **Idents** label. Hit **Enter** after each site.
3. When finished, press **Save**. A new product definition file will be created.
4. Select the **Verify** button to check whether all necessary files exist. Site info and templates must exist for all Site IDs listed in the product definition.

- ▶ **To modify an existing product**
  1. Select the product on the **Products** list.
  2. To add a new TAF site, type the ID in the window under the **Idents** label and hit **Enter**.
  3. To delete a site, select it on the **Idents** list and press the **Delete** button.
  4. Press **Save** to update product definition file.
  
- ▶ **To delete a product**
  1. Select the product on the **Products** list.
  2. Press **Delete**. A confirmation dialog will be displayed. Select **OK**; this will delete product definition file. TAF site files (info and templates) will not be removed.
  
- ▶ **To mark a product as the default**
  1. Select the product on the **Products** list.
  2. Press the **Default**. This will designate the selected product as default product.

#### 9.5.4.5 Editing TWEB Route Information using AvnFPS

From the **avnsetup** main GUI, select **TWEB Route Info** button. An empty **TWEB Route Info Editor** will display (see Exhibit 9.5.4.5-1).

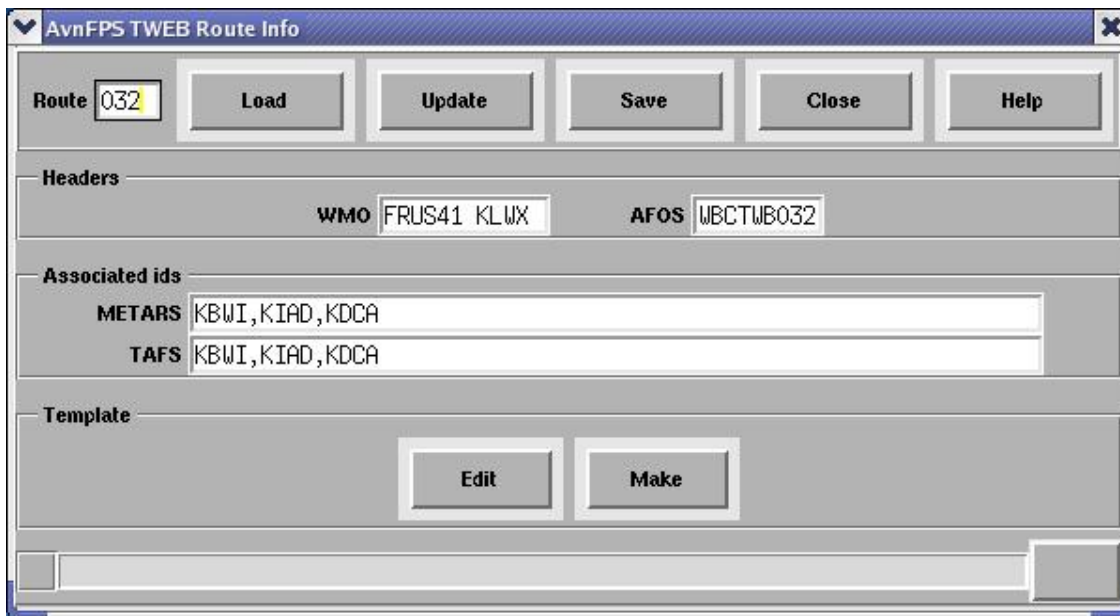

Exhibit 9.5.4.5-1. AvnFPS TWEB Route Info Editor

The TWEB Route Info Editor is an entry form for data specific for a particular route or synopsis. You must enter data for all routes before creating a product definition (that is, a “collective”). See Table 9.5.4.5-1.

**Table 9.5.4.5-1. AvnFPS TWEB Route Info Editor Fields and Descriptions**

Route	TWEB Route Number
WMO	WMO header used to transmit forecast
AFOS	The PIL used during transmission
METARS	A comma-separated list of METAR site IDs that should be displayed in the viewer window of the TWEB Editor.
TAFS	A comma-separated list of TAF site IDs that should be displayed in the viewer window of the TWEB Editor.

► **To add TWEB route data**

1. Enter the route number into the **Route** box.
2. Select the **Update** to initialize WMO and AFOS headers from the **afos2awips.txt** file.
3. Enter the METAR and TAF site IDs you want to see in the TWEB Editor in the **Associated ids** area. If you prepare TWEB products comprising more than one route, assure that the values you enter in those two fields are the same for each route listed in the product.
4. Press **Save**.
5. Select the **Make** button in the **Templates** area to create the basic template file.
6. If you want to customize the template, select **Edit** to invoke a text editor.

► **To modify TWEB route data**

1. Enter the Route Number into the box labeled **Route**.
2. Modify displayed entries as needed.
3. Select the **Save** button.

### 9.5.4.6 *Editing the AvnFPS TWEB Route Template*

The bottom part of TAF Site Editor provides tools to create and edit template files that can be used to initialize forecasts.

► **To create a TWEB template using AvnFPS**

1. Enter the Route Number into the box labeled **Route**.
2. Select the **Make** button to create a template file containing phrase:

```

NNN TWEB DDHHMM . ALL HGTS AGL EXC TOPS .
-       Where NNN is the route number.

```

► **To modify TWEB template**

1. Enter the Route Number into the box labeled Route.
2. Select Edit to invoke a text editor. *Do not* press the Make button, as this will overwrite your current template.

#### 9.5.4.7 Editing TWEB Product Definition using AvnFPS

From the **avnsetup** main GUI, select **TWEB Products** button to launch the TWEB Product Configuration Editor (see Exhibit 9.5.4.7-1).

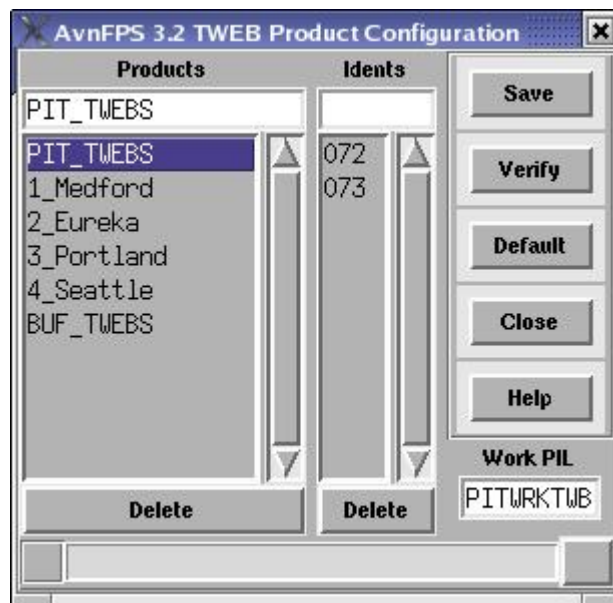

Exhibit 9.5.4.7-1. TWEB Product Configuration Editor

Existing products are displayed in the alphabetical order, with the default (if defined) on the top of the list. The **Idents** window displays list of all TWEB routes in the product.

► **To add a product**

1. Type the product name in the text window under the **Products** label and hit **Enter**. An error message will be displayed that the product cannot be loaded, this is ok.
2. Enter the site ID in the window under the **Idents** label. Hit **Enter** after each site.
3. When finished, press **Save**. A new product definition file will be created.
4. Select the **Verify** button to check whether all necessary files exist. Route info and the template must exist for all routes listed in the product definition.



- ▶ **To modify an existing product**
  1. Select the product on the **Products** list.
  2. Select the product on the list. To add a new TWEB route, type the route number in the window under the **Idents** label and hit **Enter**.
  3. To delete a route, select it on the **Idents** list and select **Delete**.
  4. Select **Save** to update product definition file.
  
- ▶ **To delete a product**
  1. Select the product on the **Products** list.
  2. Press **Delete**. A confirmation dialog will be displayed.
  3. Select **OK**; this will delete the product definition file. The TWEB route files (info and template) will not be removed.
  
- ▶ **To mark a product as the default**
  1. Select the product on the **Products** list.
  2. Select **Default**. This will designate the selected product as default product.

#### 9.5.4.8 *Creating AvnFPS Database Triggers*

AvnFPS obtains TAFs, TWEBs, and METAR observations from the **fxatext** database. As new versions of these products arrive, **fxatext** (actually, the underlying relational database engine, Postgres) can trigger the launch of an application program. AvnFPS uses this trigger feature to retrieve TAF, TWEB and METAR products for monitoring as soon as they arrive in the database. The Trigger Editor manages the configuration of the **textdb** triggers needed to support AvnFPS. The current version creates the trigger template to be processed by localization and simultaneously updates the **watchwarn** table in the **fxatext** database holding the Postgres trigger scripts. So you do not have to rerun localization after creating the template file. However the file is still necessary, as the localization process drops **watchwarn** and re-creates it from templates.

- ▶ **To start the Trigger Editor, select the Triggers button. The Trigger Editor will display.**

On startup, the Trigger Editor (see Exhibit 9.5.4.8-1) searches the AvnFPS configuration files for all TAF sites, METAR sites, and TWEB routes that have been configured for the AWIPS site. (These are files stored in the etc/tafs, etc/mtrs, and etc/twbs directories.) The three columns in the Trigger Editor, TAF, METAR and TWB, list those sites and routes. If there is a template file, etc/triggerTemplate, its entries are used to fill the corresponding PIL boxes. If the trigger template does not have an entry for an ID, then the relevant box will remain blank with a pink background. The column XTF contains entries for

extended (30 hour) TAFs. Unless your office issues such forecasts, it will be empty. Column CCFP should always have entries as shown above. Those text products are not site-specific.

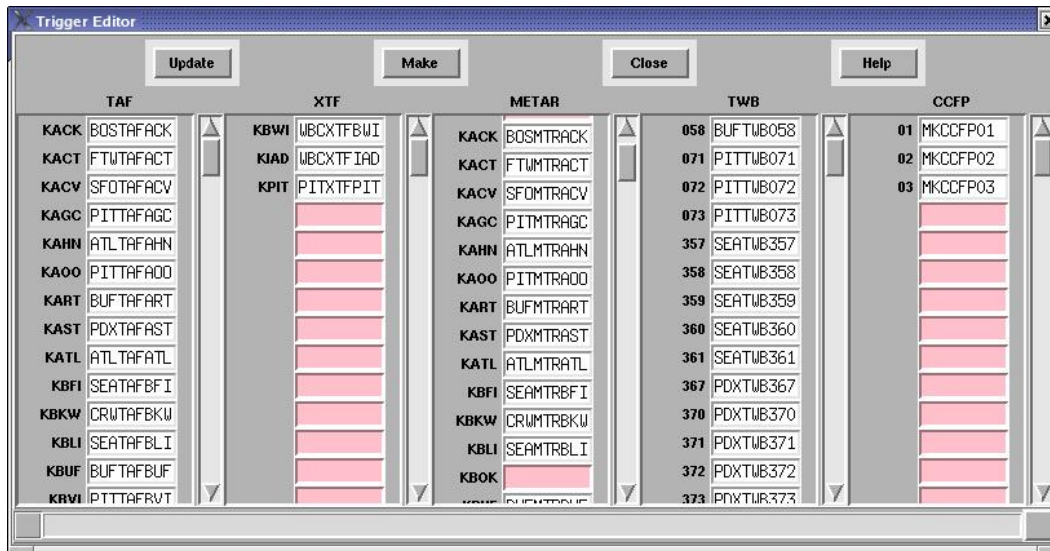

Exhibit 9.5.4.8-1. AvnFPS Trigger Editor

► **To create AvnFPS triggers**

1. Select the **Update**. The program will try to determine missing PILs for TAFs and TWEBs from the file **afos2awips.txt**. METAR PILs are created from corresponding TAF PILs by replacing TAF by MTR.

**NOTE:** The existing values will not be overwritten.

2. Correct the entries and fill in empty fields.
3. Press **Make** when finished. Empty (pink) entries will be skipped. If you have an invalid entry, an error message will display.

#### 9.5.4.9 Using the AvnFPS Text Editor

Use the text editor in AvnFPS to edit the remaining configuration files: **forecasters**, **logging.cfg**, **server.cfg**, **gui.cfg**, **ids.cfg**, **flt\_cat.cfg**, and **grp\_tag.cfg**. It is invoked by selecting **Text Edit**.

► **To edit configuration files using the AvnFPS Setup Editor**

1. From the avnsetup Main GUI, select Text Editor. The Setup Editor will display. (See Exhibit 9.5.4.9-1.)

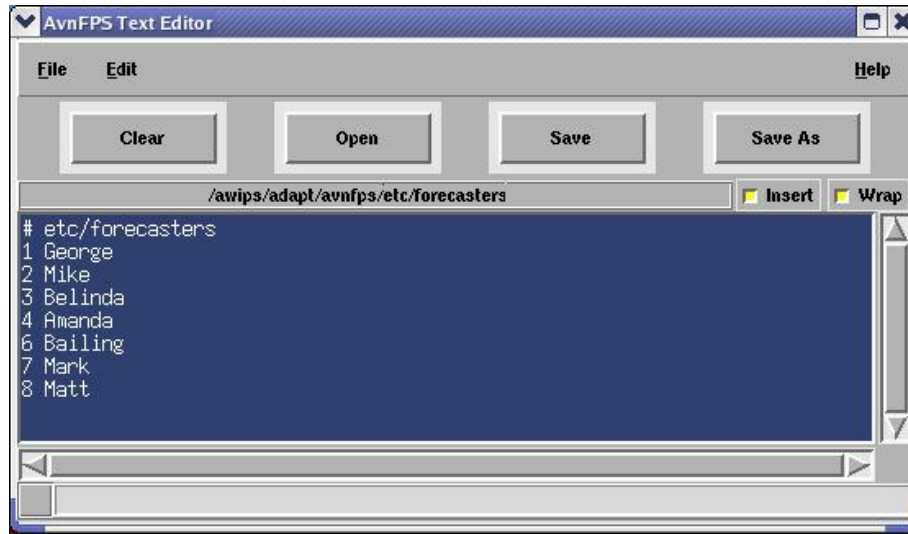

Exhibit 9.5.4.9-1. AvnFPS Setup Editor

2. Select **Open**. A file selection dialog listing the contents of directory /etc will display. (See Exhibit 9.5.4.9-2.)

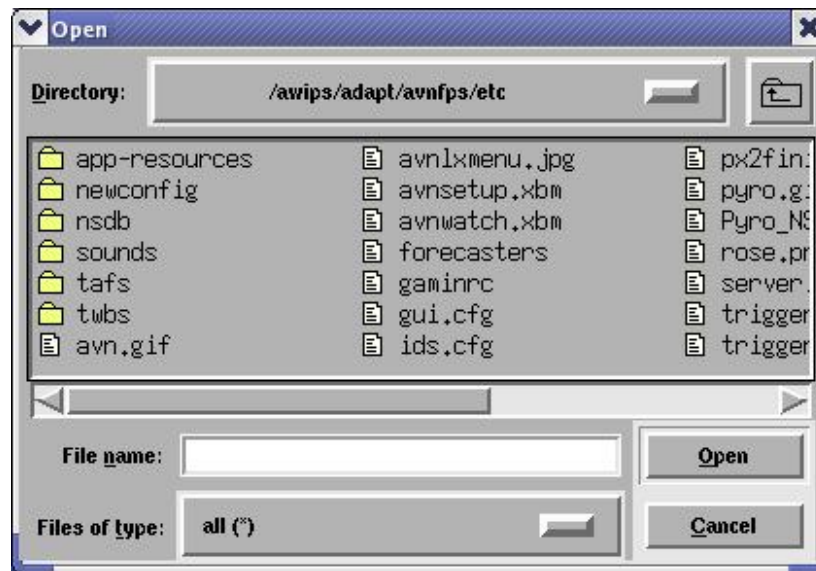

Exhibit 9.5.4.9-2. AvnFPS Text Editor Dialog

3. In this dialog, select a file to edit, then select **Open**.
4. Select **Save** when finished. If you want to create a file, simply type in its content in the text window, then select **Save As**.

You can also use the text editor to edit X resource configuration file. However it is suggested that you only modify the system-wide file that is used as an initial selection when a forecaster modifies his own resources through the graphical editor available in **AvnWatch**. Proceed as above, in the file selection dialog select first, directory **app-resources**, then the file **X**. You may edit files for individual forecasters (those with names

X.N), however any comments you enter will be stripped by the graphical editor each time the forecaster modifies the resources from **AvnWatch**.

**NOTE:** Font and color names may be cryptic. You may want to use the graphical editor in **AvnWatch** first to display color codes and available fonts.

### 9.5.5 *Configuring IFPS to Send Gridded Data to AvnFPS*

The GFE text formatter (IFPS2AvnFPS.py) was created to do the job of accessing IFPS gridded database and writing the information to the **/data/adapt/avnfps/grids** directory. **IFPS2AvnFPS.py** is run at 10 times an hour via cron on the px2f machine.

**NOTE:** The only requirement for the new text formatter to run is that all TAFs must have a GFE edit area defined in the ifpServer database. This restriction should be removed in a later build. Offices that have configured IFPS to send gridded data to AvnFPS are likely to have already satisfied this requirement.

### 9.5.6 *Logging*

AvnFPS has an extensive logging system; it is similar to collective logging in AWIPS. The amount of information written to log files and its format are configurable.

Each program has its own log file, one for each day of the week. File naming uses the scheme **progname\_DayOfWeek**, so **avndis** will produce files named **avndis\_Mon** through **avndis\_Sun**. Files are broken (old ones are closed and new ones are opened) at the first write attempt of each new day.

The file **etc/logging.cfg** controls the location, format and log level for the log files. The format and log level is the same for all programs.

**NOTE:** The log directory is local to each server/workstation. The **/awips/adapt/avnfps/3.2/logs** directory points to **/data/logs/adapt/avnfps**, which resides on the local partition. This is consistent with the AWIPS standard.

For example:

**TYPE:**        **ll /awips/adapt/avnfps/3.2/logs**

- Your output should look similar to the following:

```
lrwxrwxrwx 1 fxa falpha 23 Oct 8 16:41 /awips/adapt/avnfps/3.2/logs ->
/data/logs/adapt/avnfps
```

Here is an example listing of a log file for **avndis**:

```
Log rollover at 00:00:01
2006-03-01 00:00:01,280 DEBUG [10517:126217136] TriggerThread: Processing PHLMTRMDT
2006-03-01 00:00:01,647 INFO [10517:126217136] TextThreadP: Processed KMDT from
SAUS70 KMDT 080000
```

```

2006-03-01 00:00:01,647 DEBUG [10517:126217136] TriggerThread: Done PHLMTRMDT
2006-03-01 00:00:01,649 DEBUG [10517:126217136] TriggerThread: Processing PIIMTRDUJ
2006-03-01 00:00:01,656 DEBUG [10517:27261872] DataIngestServ: Msg: {'src': 'mtrs',
'ident': 'KMDT'}
2006-03-01 00:00:01,754 INFO [10517:126217136] TextThreadP: Processed KDUJ from
SAUS70 KDUJ 080000
2006-03-01 00:00:01,755 DEBUG [10517:126217136] TriggerThread: Done PIIMTRDUJ
2006-03-01 00:00:01,756 DEBUG [10517:126217136] TriggerThread: Processing BUFMTRART
2006-03-01 00:00:01,981 DEBUG [10517:27261872] DataIngestServ: Msg: {'src': 'mtrs',
'ident': 'KDUJ'}
2006-03-01 00:00:01,989 INFO [10517:126217136] TextThreadP: Processed KART from
SAUS70 KART 080000
2006-03-01 00:00:01,990 DEBUG [10517:126217136] TriggerThread: Done BUFMTRART
2006-03-01 00:00:01,993 DEBUG [10517:27261872] DataIngestServ: Msg: {'src': 'mtrs',
'ident': 'KART'}
2006-03-01 00:00:05,289 DEBUG [10517:126217136] TriggerThread: Processing HFOMTRHNY
2006-03-01 00:00:05,576 INFO [10517:101030832] LtgThread: Processing file
/data/fxa/point/binLightning/netcdf/20060228_2300
2006-03-01 00:00:05,629 INFO [10517:126217136] TextThreadP: Processed PHNY from
SAUS80 PHNY 080000
2006-03-01 00:00:05,631 DEBUG [10517:126217136] TriggerThread: Done HFOMTRHNY
2006-03-01 00:00:05,633 DEBUG [10517:126217136] TriggerThread: Processing BUFMTRROC
2006-03-01 00:00:06,020 DEBUG [10517:27261872] DataIngestServ: Msg: {'src': 'mtrs',
'ident': 'PHNY'}

```

Each line contains the following fields:

- Date and time of the event
- Severity level (in caps)
- Process and thread number (in square brackets)
- Python module name which generated the message
- Actual message content.

Some typical errors may include:

```

2005-07-08 02:00:48,843 INFO [10517:84941744] MosData: Retrieved ngm data for BUF
2005-07-08 02:00:48,851 ERROR [10517:84941744] MosData: BVI not in
/data/fxa/point/mos/NGM/netcdf/20050708_0000*
2005-07-08 02:00:48,882 INFO [10517:84941744] MosData: Retrieved ngm data for CHA

2005-07-08 05:32:52,556 DEBUG [10517:126217136] TriggerThread: Done MEMTAFTRI
2005-07-08 05:32:52,558 WARNING [10517:74451888] util: Daemon ** Exception during
processing of request from TCPConnection with ('xxx.xxx.xxx.xxx', 45051)
connected=1 type thread.error**
--- traceback of this exception follows:
-----
<thread.error> RAISED : can't start new thread

Extended Stacktrace follows (most recent call last)
-----
File "/awips/adapt/avnfps/Python-2.4.1/lib/python2.4/site-packages/Pyro/protocol.py",
line (922), in Daemon::connectionHandler
Source code:
    self.handleInvocation(conn)
File "/awips/adapt/avnfps/Python-2.4.1/lib/python2.4/site-packages/Pyro/core.py",
line (695), in Daemon::handleInvocation
Source code:

```

**Notes:**

- \* This message indicates problem with TAF Site Info configuration file: data for KBVI is not distributed for NGM MOS product. This does not cause any harm, but one can either select another site which is close enough, or leave the NGM MOS site id empty.
- \*\* Some messages provide detailed traceback to point out to the exact location of the code where the error occurred. In this case, the error comes from Pyro code and it is relatively serious. The data ingest server hit the threshold of allowable memory consumption. avndis has this threshold set programmatically to avoid clogging the whole operating system. In a situation like this one should restart avndis to avoid data loss. If the problem reoccurs, further investigation is required. (Note: This example is contrived; the threshold was set too low during development.)

**9.5.7 AvnFPS Troubleshooting**

Techniques for troubleshooting various aspects of AvnFPS are addressed in the Government AvnFPS system manager’s manual. This section covers some of the more likely fault scenarios and troubleshooting techniques.

**9.5.7.1 Overall AvnFPS Server Health**

A number of server processes keep AvnFPS running. A series of status lights on the TAF Monitor GUI reports the status of most of these processes. “Keep Alive” messages are sent among the servers every 30 seconds to set the colors of these status lights. Section 9.5.1, “System Overview” contains a detailed description of each server and the host on which it should be running. Server hosting can vary between AWIPS releases.

**9.5.7.1.1 Diagnostic Tools**

► **If all the server status lights are red, check for**

- A failed name/event server (**avnserver**)
- A network failure.

► **To list the AvnFPS server processes**

The command `ps` command is used to list server processes and any component threads. In the example below, the process is run on PX2 and the operating system is Red Hat Enterprise 4. The indented text in the rightmost column indicates hierarchy.

```

TYPE:          ps -efwH | grep avnpython
  ■              Your output should be similar to the following:

fxa 18615      1 0 Mar06 ? 00:00:00 avnpython /awips/adapt/avnfps/3.2/py/avninit.py px2f
fxa 18713 18615 0 Mar06 ? 00:00:33 avnpython /awips/adapt/avnfps/3.2/py/avnserver.py -d -n
px2f
fxa 18718 18615 0 Mar06 ? 00:00:01 avnpython /awips/adapt/avnfps/3.2/py/avndrs.py -d -n px2f
fxa 18730 18615 0 Mar06 ? 00:01:08 avnpython /awips/adapt/avnfps/3.2/py/avndis.py -d -n px2f
fxa 18735 18615 0 Mar06 ? 00:00:14 avnpython /awips/adapt/avnfps/3.2/py/avnxs.py -d -n px2f

ncfuser:853$

```

► **To list the threads spawned by AvnFPS server processes**

**TYPE:** `ps -efL | grep avnpython`

**NOTES:** Some comments follow:

PID	Comments	“Kill”-able?
18615	avninit daemon	Yes
18713	avnserver process	Yes
18718	Data Request Server (avndrs) process	Yes
18730	Data Ingest (avndis) process	Yes
18735	Transmit Server (avnxs) process	Yes

Threads of a process will not accept signals from a kill command. You must identify the process that owns the thread and kill that top-level process. Once a parent process terminates, all of its threads will terminate as well.

► **To diagnose connections among various AvnFPS servers**

The command `netstat -a | grep 9090` can be used to diagnose connections among the various AvnFPS servers. The name/event server uses port 9090 to disseminate information about the various servers that are up and running.

On PX2

**TYPE:** `netstat -a | grep 9090`

- Your output should be similar to the following:

```
tcp      0      0 px2f-wfo:9090          px2f-wfo:55812        ESTABLISHED
tcp      0      0 px2f-wfo:9090          px2f-wfo:55819        ESTABLISHED
tcp      0      0 px2f-wfo:55819         px2f-wfo:9090         ESTABLISHED
tcp      0      0 px2f-wfo:55812         px2f-wfo:9090         ESTABLISHED
tcp      0      0 px2f-wfo:9090          lx3-wfo:40638         ESTABLISHED
```

**NOTES:**

1. The columns are Protocol, Receive Queue, Send Queue, Local Address, Foreign Address, and State.
2. Six connections to and from the name/event server can be seen in the px2 listing.
  - The first four established connections show connections between the servers on px2 and the name/event server.
  - There is an additional connection to a process on lx3. Most likely, this is an instance of the AvnWatch GUI.

### 9.5.7.2 Log Files

Log files for AvnFPS3.2 server processes are stored in the directory tree `/data/logs/adapt/avnfps`, local to the host computer. The names of the logs files are

formed by the name of the application and the current day of the week (e. g., avnmenu\_Thu and avndis\_Fri). All applications use collective logging which means that log file entries from different instances of an application can be found, interleaved, in a single log file. The following screen capture shows sample directory listings:

### GUI logs on a workstation

```
avnclimate_Fri  avnmenu_Mon  avnmenu_Thu  avnqcstats_Tue  avnsetup_Thu  avnwatch_Mon
avnwatch_Thu
avnclimate_Wed  avnmenu_Sat  avnmenu_Tue  avnsetup_Mon    avnsetup_Tue  avnwatch_Sat
avnwatch_Tue
avnmenu_Fri     avnmenu_Sun  avnmenu_Wed  avnsetup_Sun    avnwatch_Fri  avnwatch_Sun
avnwatch_Wed
```

### Server logs on px1/px2 ...

```
avndrs_Fri  avndrs_Sun  avndrs_Wed  avninit_Sun  avninit_Wed  avnserver_Sat  avnserver_Tue
avndrs_Mon  avndrs_Thu  avninit_Fri  avninit_Thu  avnserver_Fri  avnserver_Sun  avnserver_Wed
avndrs_Sat  avndrs_Tue  avninit_Sat  avninit_Tue  avnserver_Mon  avnserver_Thu
```

It is possible for certain unexpected errors to go undetected in log files. One way to test against this possibility is to launch a GUI process from the command line and watch the standard error and standard output streams.

► **To launch the AvnFPS startup menu from the command line**

**TYPE:**            `/awips/adapt/avnfps/bin/avnstart.sh avnmenu`

### 9.5.7.3 Data Ingest

The AvnFPS Data Ingest Servers (instances of **avndis**) monitor events in AWIPS and decode various data as they become available. For some data types, the term “decode” means little more than copying a file. Once **avndis** has put the data into the AvnFPS directory tree, the AvnFPS Data Request Servers (instances of **avndrs**) serve the data to the various GUIs.

#### 9.5.7.3.1 Data Ingest Troubleshooting

The log files for **avndrs** show data being delivered to GUIs as well as data access problems. See if the GUIs are connecting to **avndrs** successfully and receiving data.

Log files for **avndis** show data arriving and being decoded. Errors are rather easy to spot in these files.

#### 9.5.7.3.2 Specific Hints for Specific Data Types

<b>Text (TAFs, METAR observations)</b>	AvnFPS database triggers deliver products to the <b>/awips/adapt/avnfps/data/text</b> directory. As an alternative to triggers, the AWIPS acquisition server can be configured to copy
----------------------------------------	----------------------------------------------------------------------------------------------------------------------------------------------------------------------------------------



	arriving text products into <b>/awips/adapt/avnfps/data/raw</b> which can be processed by <b>avndis</b>
<b>Text (TAFs, METAR observations)</b>	As an alternative to triggers, the AWIPS acquisition server can be configured to copy arriving text products into <b>/data/fxa/point/avnfps/raw</b> which can be processed by <b>avndis</b> .
<b>Lightning Observations</b>	The <b>/data/fxa/point/binLightning/netcdf</b> directory is monitored for new and updated files.
<b>Lightning Probability:</b>	The <b>/data/fxa/img/SBN/netCDF/LATLON/3hr/LTG</b> directory is monitored for new and updated files.
<b>Low-Level Wind Shear</b>	The following directories are monitored for new files: <b>/data/fxa/point/profiler/netcdf</b> <b>/data/fxa/LDAD/profiler/netCDF,</b> <b>/data/fxa/radar/CCCC/VWP,</b> where <b>CCCC</b> is the radar ID
<b>IFPS Grids</b>	IFPS controls the process that exports the data to <b>/awips/adapt/avnfps/data/grids</b> where it is monitored.

#### 9.5.7.4 Product Transmission

Product transmission is covered in depth in Section 9.5.1.4, Transmission Server.” Check the log file for **avnxs**. If a forecast prepared by AvnFPS was written to the **pending** queue, **/awips/adapt/avnfps/3.2/xmit/pending**, and the transmission server attempted to access the file, then there should be a corresponding entry, starting with the word **SUCCESS** or **FAILNNN**, where **NNN** is the code returned by the system call to **handleOUP.pl**.

If **avnxs** indicates there was a **handleOUP.pl** failure, then investigate the **handleOUP** log file, **/data/logs/fxa/<yyyymmdd>/handleOUP**.

## 9.6 NOAA Weather Radio Editor

The NOAA Weather Radio (NWR) Editor (NWRE) provides the manual Voice-Ready Product (VRP) creation and dissemination functionality on AWIPS. It consists of four basic operations:

- VRP creation from values stored in the AWIPS **fxatext** and **ifps\_<xxx>** databases, where **<xxx>** is the AWIPS site ID, all in lowercase (e.g., **sto**)
- VRP creation from a previously stored/distributed VRP stored on disk
- Creation/management of VRP default message attributes stored in the **ifps\_<xxx>** database

- Dissemination of a properly formatted VRP from AWIPS to the NWR Console Replacement System (CRS).

**NOTE:** Knowledge of proper VRP message attribute/synopsis creation and use is assumed at this point. This chapter is not meant to serve as a tutorial on proper Voice-Ready Product creation/use.

### 9.6.1 NWR Editor Setup and Configuration

In order to accomplish the NWRE's four basic tasks, the **FXA\_TEXT** and **DB\_ICWF** system environment variables must be set at the sites.

Also, one configuration data file must exist for the NWRE to execute correctly. This file is used by the **transferNWR** process to determine the proper line configuration and **CRS login** needed for successful VRP dissemination. This file must exist on each workstation used for manual VRP creation and dissemination, along with the **transferNWR** script, the **nwrEditor** script, and the **nwrEditorWish** (TclTk interpreter); the **sendToNWR** process must exist on the Data Server.

#### Configuration Files

The NWRE requires that prior to startup the following configuration files exist on each workstation that will run the NWRE. All of the files reside on the workstations in **/awips/fxa/bin** unless otherwise noted.

- **nwrEditor**. A TclTk script providing GUI access to a library of NWR-specific functionality.
- **nwrEditorWish**. A TclTk interpreter that has been extended to include NWR application-specific commands.
- **transferNWR**. An Expect script used to move voice ready products to the **/data/fxa/workFiles/nwr/ready** directory.
- **nwr.cfg**. A configuration file containing AWIPS/NWRCRS line configuration, NWRCRS login, and a line of dummy text as placeholder (this will be the NWRCRS password until CRS Build 10 is released).

The **nwr.cfg** file is located in the **\$FXA\_DATA/workFiles/nwr** directory. It is needed by the **transferNWR** and **sendToNWR** processes, and therefore the NWRE will be installed with sample entries. The system administrator will need to populate the file with site-specific line configuration, CRS login, and placeholder text. Table 9.6.1-1 shows the file format.

**Table 9.6.1-1. File Format for the nwr.cfg File**

File Name	File Line #	File Format	BNF
nwr.cfg	1. CRS login2. "placeholder text" 3. AWIPS--CRS line	0mp '\n' XXXXLAN '\n'	CRS_LOGIN><new line character><PLACEHOLDER>[new_line_character ><EOF> <LINE_CONFIG><new line character>

**NOTE:** If the file contains any information besides that shown above, the results will be undefined.

## Environment Variables

The environment variables used in discussing the NWRE are shown in Table 9.6.1-2.

**Table 9.6.1-2. Environment Variables for the NWR Editor**

Environment Variable Name	Environment Variable Definition
FXA_TEXT	The <b>fxatext</b> database
DISPLAY	Your workstation display (e.g., xt1-sto:0.0)
DB_ICWF	AWIPS site ID (e.g., sto)
LOG_PREF	/awips/fxa/data/ingestLogPref

Use the **echo** command to verify that the environment variables were set correctly during installation:

**TYPE:**        **echo \$FXA\_TEXT**

**TYPE:**        **echo \$DISPLAY**

**TYPE:**        **echo \$DB\_ICWF**

**NOTE:** The installation process should set these variables to the proper values for each workstation.

### 9.6.2 NWR Editor Event Logging

NWRE log files are generated and maintained in a log file directory on each workstation. Users can inspect pertinent log files for errors. On a workstation, log data are written to the **/data/logs/fxa/display/\$DISPLAY/<yyyymmdd>** file, where **<yyyymmdd>** is the current date in year-month-day format and **\$DISPLAY** is the display environment variable, as previously defined.

**NOTE:** Remember that the workstation logs are local to the machine from which NWRE is being run. For example, if you log in from lx5-sto to lx2-sto and set **\$DISPLAY** to lx5-sto:0.0, you will find a directory on lx2-sto named **/data/logs/fxa/lx5-sto:0.0/<yyyymmdd>** (where **<yyyymmdd>** is the current date) if you use the NWRE to send a VRP to the CRS.

**NOTE:** The full display variable is also used for the X-terms (e.g., xt1-sto:0.0) for **\$DISPLAY** and the log file pathname when the NWRE is run on an X-term. However, if you run the NWRE on a workstation, the path to the logs would be **/data/logs/fxa/display/:0/<yyyymmdd>** or **/data/logs/fxa/display/:0.0/<yyyymmdd>**.

All NWRE logs have the following naming convention:

```
nwrEditorWish<processId><server><hhmmss>
```

**Example:** nwrEditorWish1869091x2-nhda171016

NWRE log files contain minimal logging when the process runs successfully; normally only problems are logged. To see all logging from process startup to process shutdown, the **\$LOG\_PREF** file must contain an entry for the **nwrEditorWish** with debug turned on. Use of logStream's **logPreferences** configuration file is outside the scope of this discussion. The standard FSL-developed "logStream" logging mechanism is used and the formats for the logs are as documented by the logStream foundation class.

Exhibit 9.6.2-1 shows a sample NWR Editor **nwrEditorWish** log file with **\$LOG\_PREF debug=on** for the NWRE process, which would constitute normal process startup.

```
LOG-STATUS: Log file opened on host bdl-napo at Wed May 12 17:10:17 2006
17:10:16.962 VRPMessageAttributes.C DEBUG: default VRPMessageAttributes constructor called
default VRPMessageAttributes set
17:10:17.029 VRPSynopsis.C DEBUG: default constructor VRPSynopsis() called
17:10:17.029 VRPSynopsis.C DEBUG: default _vrpSynopsis = "SYNOPSISITEST"
17:10:17.030 VoiceReadyProduct.C DEBUG: VoiceReadyProduct default constructor called
17:10:17.030 VoiceReadyProduct.C DEBUG: preparing to get voice ready product in four part
structure
17:10:17.030 VRPMessageAttributes.C DEBUG: getting vrp message attributes
17:10:17.041 VRPMessageAttributes.C DEBUG: moving everything toupper() except eolac
17:10:17.042 VRPMessageAttributes.C DEBUG: returning vrp message attributes...
T_ENGCCCNXXXX04051217100004261710      AD  c0405121710
17:10:17.042 VoiceReadyProduct.C DEBUG: esca/msg attributes/ newline:
[aT_ENGCCCNXXXX04051217100405121710      AD  c0405121710
17:10:17.043 VRPSynopsis.C DEBUG: returning vrp synopsis:
SYNOPSISITEST
17:10:17.043 VoiceReadyProduct.C DEBUG: synopsis/newline/escb/endl:
SYNOPSISITEST
[b
17:10:17.044 VoiceReadyProduct.C DEBUG: successfully retrieved Voice Ready Product in four
part structure
17:10:17.044 VoiceReadyProduct.C DEBUG: vrp data is: [aT_ENGCCCNXXXX04051217100405121710
AD  c0405121710
SYNOPSISITEST
[b
```

**Exhibit 9.6.2-1. Sample NWR Editor nwrWish Log File Where debug=on**

As previously noted, the default is for the NWRE log file to record only problems with the NWRE process. In addition, a unique log file for each call to **transferNWR** can be

found in the same logging directory as the NWRE process in a file given a name with the following format:

```
logStreamExpect
```

**Example:** logStreamExpect

A more detailed log of the actual VRP transfer from AWIPS to the CRS via **sendToNWR** can be found on the PX1 in **\$LOG\_DIR/<yyyymmdd>** in a file given a name with the following format:

### logStreamExpect

During one NWRE session, a user will have:

- One log file nwrEditorwish<processid><server><hhmmss>,
- One sendToNWR logStreamExpect log file, and
- Perhaps many transferNWR logStreamExpect log files.

This ratio depends on the number of “send to CRS” sessions invoked by the user from the NWRE. Exhibit 9.6.2-2 displays a sample **sendToNWR logStreamExpect** log file.

```
LOG-STATUS: Log file opened on host px1-nhda at Wed May 12 18:48:06 2006
18:48:06.177 TclLogStream.C EVENT: File CCCNNNXXX will be automatically transferred
18:48:06.586 TclLogStream.C EVENT: Successful ping to OMP
18:48:06.809 TclLogStream.C EVENT: Successful ping to 5MP
18:48:09.265 TclLogStream.C EVENT: Master processor is OMP
18:48:09.266 TclLogStream.C EVENT: 7 ss_ms processes running on OMP currently
18:48:11.012 TclLogStream.C EVENT: transfer complete to OMP
18:48:11.228 TclLogStream.C EVENT: Successful transfer of CCCNNNXXX to OMP
```

**Exhibit 9.6.2-2. Sample sendToNWR logStreamExpect Log File**

### 9.6.3 The NWR Editor GUI

There are three ways that the NWRE process can be started:

- By selecting it from the AWIPS D2D System Control (root) menu
- The NWR Browser **Edit** button
- The Text Workstation Text Window Display **NWR Editor** button.

The Government-furnished Exhibit 9.6.3-1 shows these three ways. The NWRE is shut down by using the **File -> Close** menu selections on the **NWR Editor GUI**.

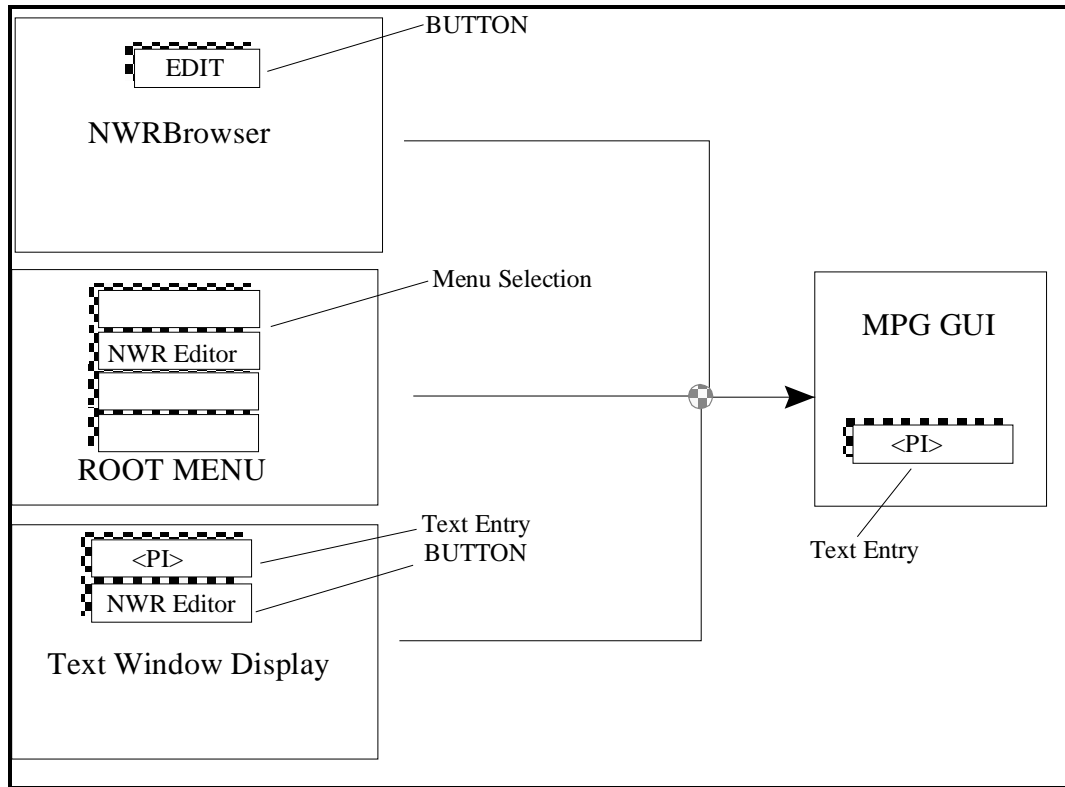

**Exhibit 9.6.3-1. NWR Editor GUI Access**

The **NWRE GUI** allows users to communicate with the **ifps\_<xxx>** database to create and manage default message attributes. Using previously stored values in the **ifps\_<xxx>** and **fxatext** databases, or by supplying the proper values, users can manually create a properly formatted VRP for public dissemination over the NWR Console Replacement System (NWR CRS).

The **NWRE GUI** was designed to emulate basic NWR CRS functionality and to include some additional features. Current NWR CRS capabilities rely on speech synthesis, tower transmission, and other features that are not present within the **NWRE GUI**. The NWRE is not meant to replace NWR CRS functionality; instead it is meant to allow an AWIPS user to access to specific NWR CRS functionality in an easy to understand and accessible manner.

To a large extent, users familiar with the NWR CRS can readily apply their working knowledge to navigate and interact with the NWRE. It is recommended that users who are unfamiliar with basic VRP generation and dissemination read the NWR CRS user's manual section dealing with a VRP's four-part structure, paying special attention to the creation of listening area codes and message reference descriptors. There are certain restrictions on the information that may be put into the NWRE's text fields. For further information on the legal values for these fields, please refer to Government NWR CRS manuals.

The **NWRE GUI** provides access to VRP generation via three routes:

- The concatenation of default message attributes stored in the **ifps\_<xxx>** database and the synopsis created from text products stored in the **fxatext** database
- The retrieval of a previously formatted and disk-stored (flat file) VRP
- The provision of required values (message attributes and synopsis) for a new VRP.

The **NWRE GUI** provides the user with the following options:

- Default message attribute creation/management
- VRP dissemination
- VRP request from stored values
- Disk/database storage of part or whole VRPs.

The **NWRE GUI** is displayed in Exhibit 9.6.3-2.

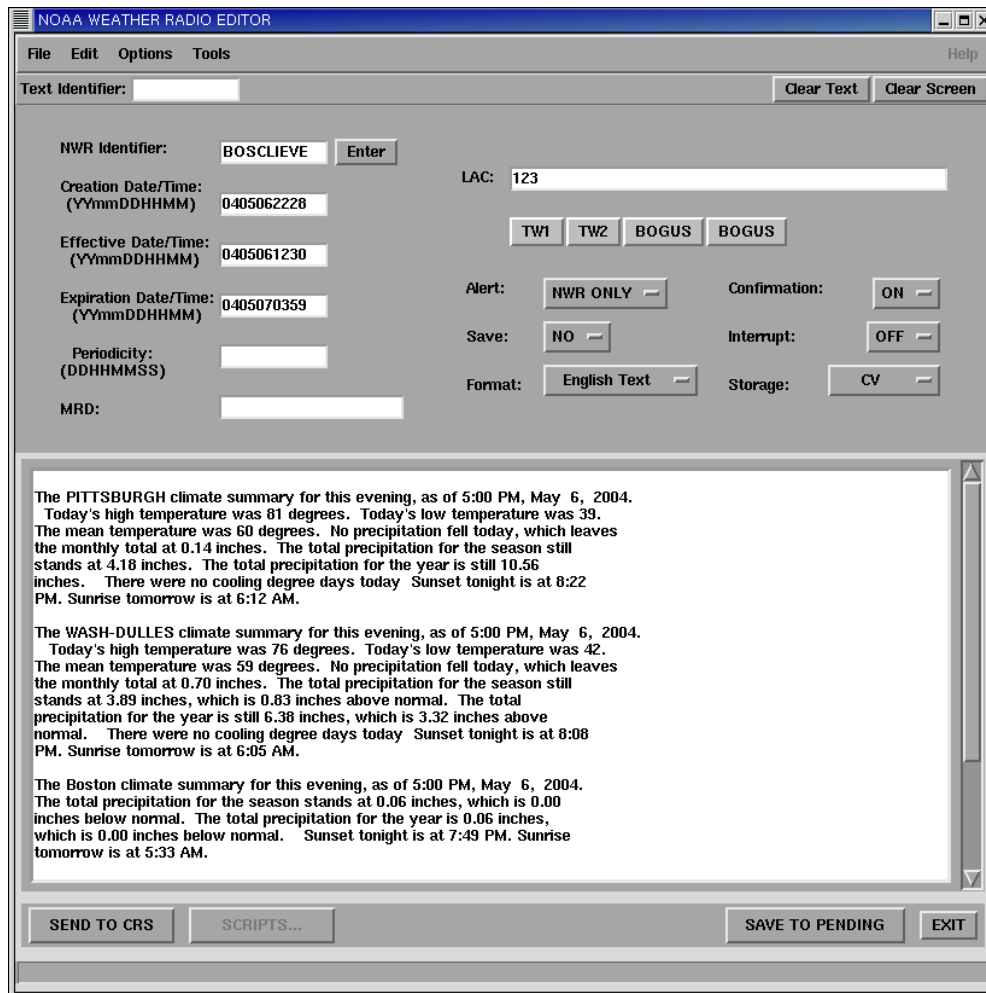

**Exhibit 9.6.3-2. The NWR EditorGUI**

The upper-half of the GUI is used to configure the following message attributes:

- Text identifier - Loads a product from the database into the Editor

- NWR identifier - AFOS ID (CCCNXX), where
    - CCC is the AFOS node origination site.
    - NNN is the AFOS-based product category.
    - X ([X] | [XX]) is the AFOS-based specific product category.
- Creation date and time
- Effective date and time
- Expiration date and time
- Periodicity
- Listening area codes (LAC)
- Message reference descriptor (MRD)
- Alert
- Save
- Format
- Confirmation
- Interrupt
- Storage

The lower half of the **NWRE GUI** is concerned with the configuration of the message contents, also known as the **Synopsis**, and is a free text area.

The very bottom of the **NWRE GUI** displays quick buttons for product dissemination and saving to disk and a status bar to keep the user informed.

#### 9.6.4 *NWR Editor Application Design Overview*

The **NWRE GUI** layer is a thin layer that sits on **nwrEditorWish**, a Tcl/Tk interpreter that has been extended to incorporate NWR application-specific commands. The GUI is a facade to the underlying NWR functionality. This was accomplished by decoupling the GUI from the interpreter. By creating an NWR-specific interpreter, applications needing application-specific commands are easily and efficiently expanded using the underlying C++ classes. This allows for the overhead incurred from scripts to be minimized to the small amount needed for display of the GUI. The GUI is responsible for sending events to the interpreter where, upon notification from the event handler, the interpreter processes the GUI's request.

All requests to the underlying functionality are broken into two types of events, **Get()** and **Set()**, based on the facade and command patterns.



Exhibit 9.6.4-1 presents a Government-furnished high-level design with the NWR Editor (Tcl script) layer on top of the VRP Generator. C/C++ function calls are shown as thin arrows and Tcl command calls are shown as thick arrows.

- The Tcl C library implements the interpreter and the core Tcl commands such as **set**, **while**, **proc**, **open**, and **socket**.
- Application-specific Tcl commands are implemented in C++ and registered as commands in the interpreter.
- The interface to all Tcl commands is the same.
- The interpreter calls these com procedures when the script uses a Tcl command.
- The application-specific command procedures are thin layers over existing functionality in extensions that implement suites of Tcl commands in the compiled code.
- In the exhibit, the large arrow represents calls from the VRP Generator back to the **MPG GUI** script layer. The application can call out to the script layer at any point, even inside command procedures.

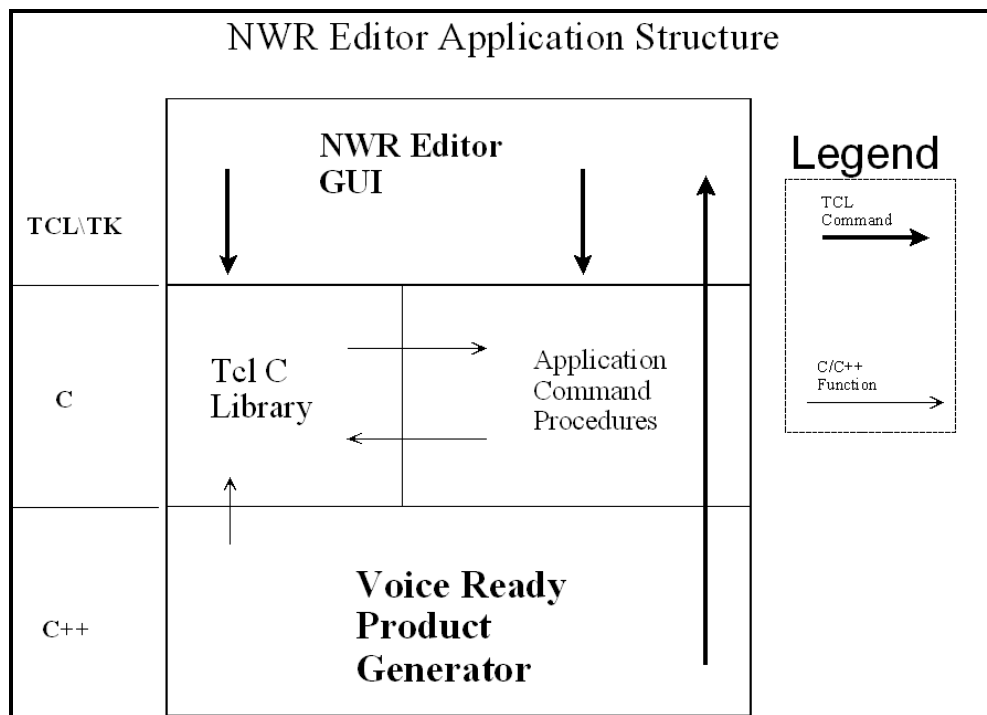

**Exhibit 9.6.4-1. NWR Editor Application Structure High-Level Design Overview**

Exhibit 9.6.4-2 presents a Government-furnished system-level view of the application.

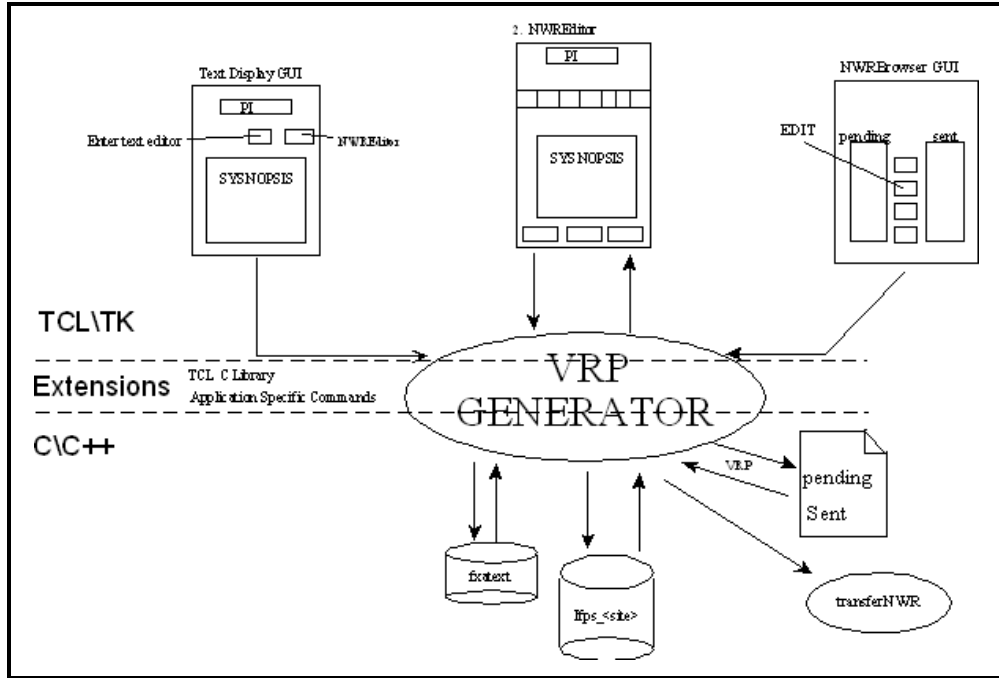

Exhibit 9.6.4-2. NWR Editor Application Structure – System View

# **Chapter 10**

## **Asynchronous Product Scheduler**

## Chapter 10. Asynchronous Product Scheduler

### Table of Contents

	<i>Page</i>
10.1 Configuration Files and Environment Variables .....	2
10.2 Processes .....	3
10.3 Additional Notes .....	6

### List of Exhibits

Exhibit 10.2-1. Acquire and Ingest of Asynchronous Products .....	4
-------------------------------------------------------------------	---

The Asynchronous Product Scheduler (APS) product distribution allows text products to be routed to/from external PCs configured on an AWIPS communications port. APS supports text product dissemination from the PC to the Console Replacement System (CRS) and the NOAA Weather Wire Service (NWWS) as well as storage of text products to the AWIPS text database.

APS runs on Linux pre-processors. It consists of eight executables that run together as a daemon to:

- Receive newly arrived text database products in real time
- Receive newly arrived text products in real time
- Ingest locally generated text products into AWIPS
- Send requests for text products
- Send requests for text database products.

The executables are located in */awips/fxa/bin*, and are described as follows.

- The *asyncScheduler* spawns *asyncLine*, one per *aps\_line.tbl* entry and *asyncExec* to route incoming products.
- The *asyncLine* is a persistent process that is spawned by *asyncScheduler* to handle serial port I/O.
- The *asyncExec* is spawned by *asyncScheduler* to route incoming products (to the Network Control Facility (NCF) and NWWS and/or CRS, depending on the product's entry in *aps\_pil.tbl*).
- The *asyncPilMsgServer* is a persistent process. It receives the notification messages from *asyncPilNotify* process.
- The *asyncPilNotify* is called by the *asyncPollData.pl* persistent process when a user-subscribed product arrives.
- The *asyncPollData.pl* is a persistent process. It constantly scouts the products arriving at the */\${EDEX\_FXA\_HOME}/workFiles/asyncScheduler/incoming* directory.
- The *asyncWatchDog.sh* is a persistent cron process. It monitors the existence of the *asyncPollData.pl* process every second. If it does not exist, it automatically starts it up.
- The *asyncPilTrigger.sh* is a process invoked by the *asyncScheduler* process to subscribe the user-defined products to the metadata database during *asyncScheduler* startup. It also instructs the EDEX textdb server where to deposit the incoming product.

## 10.1 Configuration Files and Environment Variables

Three configuration files tell the APS what products to process and how to process them. These files are located in **\$FXA\_DATA/workFiles/asyncProdScheduler**, which is NFS-mounted from the NAS.

- **aps\_line.tbl.** This file is the comms line configuration file for **asyncScheduler**, which provides line configuration settings on initial startup. It has the following format:

```

0 | test1 | 1 | /dev/tty1a | 9600 | 8 | NONE | 1 |
0 | test2 | 1 | /dev/tty1b | 9600 | 8 | NONE | 1 |
# 0 | fema | 1 | /dev/tty1b | 9600 | 7 | EVEN | 1 |
# 3 | tty1c | 1 | /dev/tty1c | 9600 | 8 | NONE | 1 | NONE
# 4 | tty1d | 1 | /dev/tty1d | 9600 | 8 | NONE | 1 | SW
# 5 | tty1e | 1 | /dev/tty1e | 1200 | 8 | NONE | 1 | HW
# 6 | tty1f | 1 | /dev/tty1f | 9600 | 8 | NONE | 1 |
# 7 | tty1g | 1 | /dev/tty1g | 9600 | 8 | NONE | 1 |
# 8 | | | | | | | | |

```

# . first line ignored for backwards compatibility

# . delimit fields with '|'

# . spaces and tabs are ignored

- A child process is spawned for each line entry.
- *Line Name:* The string of characters in the second field.
- *Status:* Legal values are "0" (not activated) and "1"(activated).
- *Device Name:* Use the full path. or the 8-port board from Digi, it will look something like /dev/tty1a
- *Baud:* Device speed, in bps. Use only well known values (2400, 4800, 9600, etc.).
- *Data Bits:* Character size. It must be 5, 6, 7, or 8.
- *Parity:* Must be "NONE", "ODD", or "EVEN"
- *Stop Bits:* 1 or 2
- *Flow Control:* Optional. Use "SW", "HW", or "NONE" (the default).

SW = xon/xoff

HW = rts/cts

This file provides a data field to specify a device file associated with a port. Great care must be taken to ensure that the device file specified for each line is correct; otherwise, the results are undefined.

- **aps\_pil.tbl.** This file is the *asyncScheduler*'s routing table. The *asyncScheduler* routes products in two directions:
  - From the text database to one or more async mux ports.
  - From one or more async mux ports to the text database. Additionally, products received in this way (i.e., from **commsLine** clients via the mux) are routed to the NCF, and may also be routed to either or both CRS and NWWS. CRS/NWWS routing is controlled by the 4th field, "Routing."

Example:

```
PID   |Line #|Priority|Routing
-----|-----|-----|-----
AAABBBCCC | 0   | 2     | CRS, NWWS
AAABABCCC | 0   | 3     |
```

**Note:** ID, Line #, and Priority fields are required. The Routing field is optional.

- Line # should have a corresponding entry in *aps\_line.tbl*. This is enforced at runtime.
  - Priority can be 1 (highest), 2, or 3 (lowest)
  - Legal Routing field entries are "CRS" and "NWWS"
    - When product AAABBBCCC enters the text database, it will be retrieved by the *asyncScheduler* and sent to line 0 (defined in **aps\_line.tbl**) with priority 2.
    - When product AAABABCCC enters the text database, it will be retrieved by the *asyncScheduler* and sent to line 0 with priority 3.
    - When product AAABBBCCC is received from the **commsLine** client connected to line 0, it is written to the text database, sent to the NCF, and then sent to CRS and NWWS.
    - When product AAABABCCC is received from the **commsLine** client connected to line 0, it is written to the text database and sent to the NCF. It is not sent to CRS or to NWWS because the fourth field is blank.
- **aps\_route.tbl.** This file lists valid APS routing keywords (e.g., NWWS, CRS).

## 10.2 Processes

Exhibit 10.2-1 describes the Asynchronous Product Scheduler data flow.

Config Files:

\$FXA\_DATA/workFile/asyncProdScheduler/aps\_line.tlb  
 \$FXA\_DATA/workFiles/asyncProdScheduler/aps\_pil.tbl  
 \$FXA\_DATA/workFiles/asyncProdScheduler/aps\_route.tbl

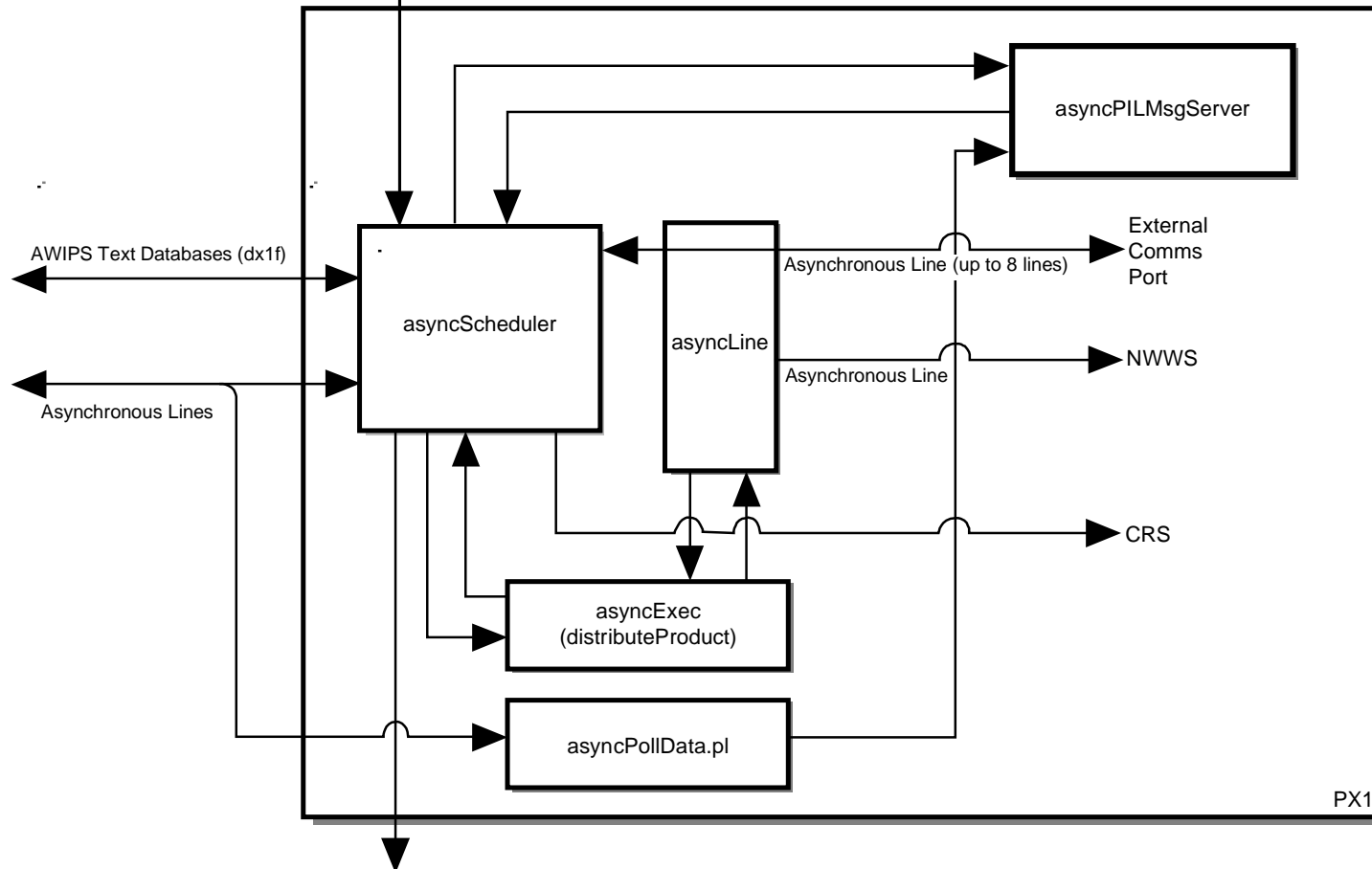

Log Files:

\$LOG\_DIR/<yyyymmdd>/asyncScheduler<logid>

Data Files:

Databases:

SMM 01/21/12

**Exhibit 10.2-1. Acquire and Ingest of Asynchronous Products**



AsyncScheduler is the parent process, responsible for transferring products from the text database to **commsLine** clients, and from **commsLine** clients to the text database, the NCF, and possibly CRS and/or NWS (depending on the product entry's "route" field in **aps\_pil.tbl**). At startup, it subscribes user-defined products in **aps\_pil.tbl** to the subscription table in the metadata database during system startup. In the meantime, it spawns one persistent port-controlling child process for each entry in **aps\_line.tbl**. It then waits for input notification from either the **asyncPilMsgServer** or any one of up to eight child processes (one per **aps\_line.tbl** entry). Each notification is checked against the list of PILs in **aps\_pil.tbl** (**aps\_pil.tbl** entries are sorted in a Standard Template Library (STL) map, keyed by PIL for quick searches). With each match, a command line *textdb* call to **EDEX textdb server** is made for the product, which is then appropriately formatted and sent to the child **commsLine**-controlling process of each matched line.

When a product matches a user-subscribed product, the EDEX trigger will call `asyncPilTrigger.sh` to copy the incoming product PIL into `#{FXA_DATA}/workFiles/asyncProdScheduler/incoming` directory.

When the **asyncPollData.pl** detects a product's PIL has arrived at `#{FXA_DATA}/workFiles/asyncProdScheduler/incoming`, it invokes the `asyncPilNotify` process to send the PIL to **asyncPilMsgServer**.

The **asyncPilMsgServer** sends the PIL to **APSPilMsgClient**, which then sends the PIL to **asyncScheduler**.

AsyncScheduler uses the `'textdb -r'` command line to read the product from the `fxatext` database and routes the data to the user via AsyncScheduler's `CommsLines/ports`.

When a user sends a text product, via AsyncScheduler's `CommsLines/ports`, from an application to the AsyncScheduler for storage to the text database, AsyncScheduler writes the text products into a temporary filename in `PIL_timeStamp` format to `#{EDEX_FXA_HOME}/workFiles/asyncProdScheduler` directory and calls `'textdb -w'` command line to store it into the `fxatext` database. AsyncScheduler removes the temporary file after successful storage to the `fxatext` database.

The **asyncLine** is the **commsLine** controlling process, spawned by *asyncScheduler*. There will be one process running for each entry in **aps\_line.tbl**. The *asyncLine* is responsible for passing products from *asyncScheduler* to the comms port, and from the comms port to *asyncScheduler*.

**Note:** Even though this executable's name is *asyncLine*, it is spawned by *asyncScheduler* with its `argv[0]` set to the second ("Line Name") field of its entry in **aps\_line.tbl**. For example, if **aps\_line.tbl** contained the single entry

```
#Line #|Line Name|Status|Device Name|Baud|DataBits|Parity|StopBits|FlowControl
#-----
   1  |bubble   |1      |/dev/ttyl1a|1200|8      |NONE  |1      |HW
```

Then the *asyncScheduler* would spawn one child *asyncLine* process and name it "bubble." The child would log to the file `bubble<pid><hostname><hhmmss>`.

Products from **commsLine** clients (i.e., products received from the serial port) are truncated precisely on the “ZCZC”/”NNN” boundary before being sent to the parent (the parent only sees the complete products from *asyncLine*). Products received from the parent are put into a priority queue, as specified by that product’s priority setting in **aps\_pil.tbl**. Products in the queue are then written out to the port as the port becomes available, highest priority first. Each line currently maintains 3 priority queues, “1”–“3”, “1” being the highest priority. An **aps\_pil.tbl** entry with an out-of-range value set to “0” will be assigned the highest priority. All other out-of-range values will be reassigned the lowest priority, “3.” Each line enforces a maximum queue size, currently set to 1,000 products. If a product is received from the parent (*asyncScheduler*) when there are already 1,000 products queued, it will be dropped. No special attempt is made to re-order the queue according to priority (i.e., a newly received Priority One product does not bump a Priority Three product from a full queue – the Priority One product is dropped).

The **asyncExec** spawns **distributeProduct** for products received from **commsLine** clients. It is not persistent (i.e., it returns with **distributeProduct**’s return value).

### 10.3 Additional Notes

- AWIPS II AsyncScheduler still assumes the 'textdb' executable is placed under the \$FXA\_HOME/bin directory (it is wrapped to CLI/bin directory).
- The AsyncScheduler trigger log file is placed in the \$EDEX\_HOME/logs/apsPilTrigger.log on the primary EDEX server.
- The AsyncScheduler trigger script, asyncPilTrigger.sh, is placed in the \$EDEX\_HOME/bin.
- The current AsyncScheduler subscription command is implemented as: textdb -ldad -a <pil> \$EDEX\_HOME/bin/asyncPilTrigger.sh.
- Legacy logging for the asyncScheduler still exists; therefore, the logs for the process itself will go to /data/logs/fxa/YYYYMMDD on px1.
- The legacy startIngest.px1 changes the modifications of the device files for the dgnc. Because this is not run under AWIPS II at this time, ensure that the /dev/tty\* are 666 modifications to allow proper functionality.

# **Chapter 11**

## **Crons and Purging**

## Chapter 11. Crons and Purging

### Table of Contents

	Page
11.1 Crons .....	1
11.1.1 Site Local Crons .....	1
11.1.1.1 How to Modify Site Standard Crons .....	2
11.1.1.2 How to Modify Site HA Crons .....	4
11.1.2 Workstation Crons .....	7
11.1.3 DX Crons .....	9
11.1.3.1 WFO DX Standard Crons .....	9
11.1.3.2 WFO dx1f HA Crons .....	11
11.1.3.3 WFO dx2f HA Crons .....	13
11.1.4 PX Crons .....	13
11.1.4.1 WFO PX Standard Crons .....	13
11.1.4.2 WFO px1f HA Crons .....	14
11.1.4.3 WFO px2f HA Crons .....	16
11.1.5 WFO LS Crons .....	17
11.1.5.1 WFO LS Standard Crons .....	17
11.1.5.2 WFO LS HA Crons .....	17
11.1.6 WFO CSPBN Crons .....	18
11.1.7 WFO AX Crons .....	18
11.1.8 Archiver Crons .....	19
11.2 quartz .....	20
11.3 EDEX Log File Purging .....	22
11.4 Verifying WFO Raw Data Storage and Archive Purging .....	23
11.5 Verifying RFC and NC Raw Data Storage Purging .....	31
11.6 Processed Data Storage Purging .....	33
11.7 Verifying Processed Data Storage Purging .....	36
11.8 Locating a Script .....	39
11.9 Hydro Cron Control Application Tokens .....	40
11.6.1 Configuration .....	40
11.6.2 Site-Specific Configurations .....	41

11.6.3 Logging .....43

### List of Tables

Table 11.1.1-1. Site Standard crons ..... 1  
 Table 11.1.1-2. Site HA crons ..... 2  
 Table 11.1.1.1-1. Modifying Site Standard crons..... 3  
 Table 11.1.2-1. WFO Workstation crons..... 8  
 Table 11.1.3.1-1. WFO DX Standard crons..... 10  
 Table 11.1.3.2-1. WFO dx1f HA crons ..... 11  
 Table 11.1.3.3-1. WFO dx2f HA crons ..... 13  
 Table 11.1.4.1-1. WFO PX Standard crons ..... 13  
 Table 11.1.4.2-1. WFO px1f HA crons ..... 15  
 Table 11.1.4.3-1. WFO px2f HA crons ..... 17  
 Table 11.1.5.1-1. WFO LS Standard Crons..... 17  
 Table 11.1.5.2-1. WFO LS HA Crons ..... 18  
 Table 11.1.6-1. WFO CPSBN crons..... 18  
 Table 11.1.7-1. WFO AX Crons..... 19  
 Table 11.2-1. Crons Jobs and Associated Schedules for AWIPS II ..... 21  
 Table 11.5-1. Cron Locations ..... 40

## 11.1 Crons

Each hardware device (server, processor, and workstation) contains baseline crons that perform system checks, purges, and backups. Sites are also provided cron files for local use.

AWIPS crons are maintained and executed in one of 3 ways:

- **Standard Linux cron.** These crons are updated and executed according to **man 8 cron**, **man 1 crontab**, and **man 5 crontab**. Both workstations and servers have standard crons running.
- **Linux High Availability (HA) crons.** These crons are part of the failover heartbeat and are maintained in the `/etc/ha.d/cron.d/` directories on the px1/px2, dx1/dx2 and ls2/ls3 HA clusters. Editing the copied version in `/etc/cron.d/` without copying the changes to `/etc/ha.d/cron.d/` will result in the loss of your changes the next time the cron is activated from its maintained location.
- **Quartz.** These time-based jobs are compiled into EDEX running on dx3/dx4. Quartz jobs can execute outside of cron or they can be loaded into cron with a java call.

**Note:** AWIPS II makes minimal use of Linux cron jobs for data processing. Instead, operations such as data purging, SmartInit, and other periodic data processing operations are triggered using quartz timer events. The quartz timer is a time-based event generator that is part of the Camel SOA infrastructure underlying the EDEX processes. The quartz timer mechanism allows EDEX services to run at specified times.

AWIPS II uses heartbeat-managed cron jobs on the PX1/2 cluster and the DX1/2 cluster. The crons are staged in `/etc/ha.d/cron.d` and are installed into `/etc/cron.d` when activated. The file names of the AWIPS II crons begin with “a2” – a2px1cron, a2px2cron, a2dx1cron, and a2dx2cron.

### 11.1.1 Site Local Crons

Sites can configure local crons in two ways:

- Standard crons on a workstation or sever
- HA crons on a failover pair

Sites should be careful to avoid conflicts between local crons and existing baseline crons. Sites should not modify baseline cron files as this may have a negative impact on system performance, and baseline files may be overwritten with the next software upgrade.

Table 11.1.1-1 identifies site standard crons; Table 11.1.1-2 identifies HA crons.

**Table 11.1.1-1. Site Standard crons**

Directory
<code>/var/spool/cron/&lt;username&gt;</code>

/etc/cron.d/
/etc/cron.hourly/ /etc/cron.daily/ /etc/cron.weekly/ /etc/cron.monthly/

**Table 11.1.1-2. Site HA crons**

Server	Site cron File	Directory
dx1f	a2SITEdx1cron	/etc/ha.d/cron.d (and /etc.cron.d on the active server)
dx2f	a2SITEdx2cron	/etc/ha.d/cron.d (and /etc.cron.d on the active server)
px1f	a2SITEpx1cron	/etc/ha.d/cron.d (and /etc.cron.d on the active server)
px2f	a2SITEpx2cron	/etc/ha.d/cron.d (and /etc.cron.d on the active server)
ls	SITElscron	/etc/ha.d/cron.d (and /etc.cron.d on the active server)

Sites that configure HA crons must keep the crons in sync across servers and between the /etc/cron.d and /etc/ha.d/cron.d directories on the active server.

**NOTE:** ALL cron files in the /etc/cron.d directory are active. Do not place ANY backup files (e.g., SITEpx1cron.bak) in the /etc/cron.d directory because crond does not discriminate and will run every job in every file in the directory. Save them in a directory reserved for SITE use that will not be overwritten by a software upgrade (e.g., /awips/dev/SITE\_crons, /home/SAlocal/SITE\_crons).

**NOTE:** Standard BOIVerify crons have been delivered as part of the local site a2SITEpx2cron. Sites should modify the existing a2SITEpx2cron for their BOIVerify and other related local app needs.

### 11.1.1.1 How to Modify Site Standard Crons

Sites can create cron files in directories managed by crond. These crons will be available when the machine is up; they are not part of the HA failover crons.

The cron daemon checks the /etc/crontab file, the /etc/cron.d/ directory, and the /var/spool/cron/ directory every minute for changes. Any changes found are loaded into memory. crontab does not need to be restarted. See Table 11.1.1.1-1.

**Table 11.1.1.1-1. Modifying Site Standard crons**

Directory	Format
/var/spool/cron/<username>	<p>Cron files here have names that match usernames in /etc/passwd. These files are executed using the permissions of the username. Users can create files here as their account name using crontab -e, if permission is granted in /etc/cron.allow and/or /etc/cron.deny. Entries are similar to /etc/crontab:</p> <pre> minute hour day month dayofweek command       field          allowed values ----- Minute             0-59 hour               0-23 day of month       1-31 month              1-12 day of week        0-7 (0 or 7 is Sun) </pre>
/etc/cron.d/	The files in these directories are in the same format as /etc/crontab.
<p><b>/etc/cron.hourly/</b>  inn-cron-nntpsend  inn-cron-rnews  <b>/etc/cron.daily/</b>  00webalizer  certwatch  logrotate  prelink  tmpwatch  0anacron  cups  makewhatis.cron rpm  0logwatch  inn-cron-expire  mlocate.cron  tetex.cron  <b>/etc/cron.weekly/</b>  0anacron  99-raid-check  makewhatis.cron  <b>/etc/cron.monthly/</b>  0anacron</p>	The files in these directories are shell scripts executed by the run-parts script entries in /etc/crontab.

The following example shows a user-created cron in /var/spool/cron that runs with the permissions of the user. **Note:** Output files are created with permissions of the user, this is a consideration when using these type of crons operationally.

```
lx4-ntcd{rschup}118: crontab -e
```

```
* * * * * echo "test" > ~rschup/test_cron
```

```
:wq
```

```
"/tmp/crontab.XXXXQ1St1T" 1L, 42C written
```

```
crontab: installing new crontab
```



```

lx4-ntcd{rschup}111: crontab -l
* * * * * echo "test" > ~rschup/test_cron

lx4-ntcd{rschup}114: date
Mon Mar 14 18:36:20 GMT 2011

lx4-ntcd{rschup}117: ls -l test_cron
-rw-r--r-- 1 rschup fxalpha 5 Mar 14 18:37 test_cron

lx4-ntcd{rschup}118: crontab -r
no crontab for rschup

lx4-ntcd{rschup}119: crontab -l
no crontab for rschup

```

### 11.1.1.2 How to Modify Site HA Crons

Modification and activation of site HA crons requires the following steps:

1. Login to the active server for the HA package
2. Modify /etc/ha.d/cron.d/a2SITE<host>cron with local changes
3. Copy /etc/ha.d/cron.d/a2SITE<host>cron to the failover pair
4. Copy /etc/ha.d/cron.d/a2SITE<host>cron to the active server /etc/cron.d/

**NOTE:** Do not leave backup files in /etc/ha.d/cron.d. They could affect the swap process. Ensure that /etc/ha.d/cron.d contains only the files expected to be there.

#### Modifying DX a2SITE Crons

In the following example, the `hb_stat` command shows the `dx1f` package is running on `dx1` and the HA cronfiles are `a2dx1cron`, `a2SITEdx1cron`. The local site `a2SITEdx1cron` will be copied from the site created backup directory `/home/SAlocal/d.CRONS/` into the `/etc/ha.d/cron.d/` directory on each failover pair and into `/etc/cron.d/` on the active `dx1f` server. The `crond` daemon checks `/etc/cron.d/` for changes every minute, so the running `crond` does not have to be restarted. The output from the cron is checked in `/awips/dev/`, then the test is removed from the system. Modifying the `dx2f` cron `a2SITEdx2cron` follows the same procedure.

```

root@dx1f's password:
[root@dx1-ntcb ~]# hb_stat
Heartbeat Status Monitor
Mar 29 16:44:03

```

```

===== Member Status =====

```

Member	Status	IP address
dx1-ntcb	Up	165.92.107.131
dx2-ntcb	Up	165.92.107.132

```

===== Service Status =====

```

Service	IPaddr	Cronfile	Owner	Start Time
a2dx1apps	165.92.107.195	a2dx1cron,a2SIT	dx1-ntcb	2011-03-23 21:32:03
a2dx2apps	165.92.107.196	a2dx2cron,a2SIT	dx2-ntcb	2011-03-14 16:11:12

```

[root@dx1-ntcb cron.d]# cd /etc/ha.d/cron.d

```

```

[root@dx1-ntcb cron.d]# ls -l a2SITE*

```

```

-rw-r--r-- 1 root root 0 Mar 14 19:14 a2SITEdx1cron
-rw-r--r-- 1 root root 0 Mar 14 16:01 a2SITEdx2cron

```

```

[root@dx1-ntcb cron.d]# cat /home/SAlocal/d.CRONS/a2SITEdx1cron
* * * * * fxa echo "test" > /awips/dev/test_cron

```

```

[root@dx1-ntcb cron.d]# cp /home/SAlocal/d.CRONS/a2SITEdx1cron .
cp: overwrite `./a2SITEdx1cron'? y

```

```

[root@dx1-ntcb cron.d]# ls -l a2SITE*
-rw-r--r-- 1 root root 50 Mar 29 16:55 a2SITEdx1cron
-rw-r--r-- 1 root root 0 Mar 14 16:01 a2SITEdx2cron

```

```

[root@dx1-ntcb cron.d]# scp -p a2SITEdx1cron dx2:/etc/ha.d/cron.d/
a2SITEdx1cron

```

```

100% 50 0.1KB/s 00:00

```

```

[root@dx1-ntcb cron.d]# cp a2SITEdx1cron /etc/cron.d
cp: overwrite `/etc/cron.d/a2SITEdx1cron'? y

```

```

[root@dx1-ntcb cron.d]# ls -l /awips/dev/test_cron
-rw-r--r-- 1 fxa fxalpha 5 Mar 29 18:33 /awips/dev/test_cron

```

```

[root@dx1-ntcb cron.d]# cat /dev/null > a2SITEdx1cron

```

```

[root@dx1-ntcb cron.d]# ls -l a2SITEdx1cron
-rw-r--r-- 1 root root 0 Mar 29 18:36 a2SITEdx1cron

```

```

[root@dx1-ntcb cron.d]# scp a2SITEdx1cron dx2:/etc/ha.d/cron.d/

```

```
a2SITEdx1cron 100% 0 0.0KB/s 00:00
```

```
[root@dx1-ntcb cron.d]# cp a2SITEdx1cron /etc/cron.d/
cp: overwrite `/etc/cron.d/a2SITEdx1cron'? Y
```

```
[root@dx1-ntcb cron.d]# rm /awips/dev/test_cron
rm: remove regular file `/awips/dev/test_cron'? y
```

### Modifying PX a2SITE Crons

The following example shows the normal px1f/px2f configuration. Site crons are synchronized across px1/px2 and /etc/ha.d/cron.d. Modifying px1f/px2f a2SITE crons follows the same procedure as described for dx1f/dx2f

```
[root@px1-ntcb ~]# hb_stat
```

```
Heartbeat Status Monitor
```

```
Mar 14 15:35:21
```

```
===== Member Status =====
```

Member	Status	IP address
px1-ntcb	Up	165.92.107.137
px2-ntcb	Up	165.92.107.138

```
===== Service Status =====
```

Service	IPaddr	Cronfile	Owner	Start Time
a2px1apps	165.92.107.193	a2px1cron,a2SIT	px1-ntcb	2011-02-22 19:44:12
a2px2apps	165.92.107.194	a2px2cron,a2SIT	px2-ntcb	2011-03-01 21:38:50

```
[root@px1-ntcb ~]# ls -l /etc/cron.d/a2SITE*
```

```
-rw-r--r-- 1 root root 256 Feb 22 19:44 /etc/cron.d/a2SITEpx1cron
```

```
[root@px1-ntcb ~]# ls -l /etc/ha.d/cron.d/a2SITE*
```

```
-rw-r--r-- 1 root root 256 Feb 22 19:41 /etc/ha.d/cron.d/a2SITEpx1cron
```

```
-rw-r--r-- 1 root root 0 Feb 22 19:41 /etc/ha.d/cron.d/a2SITEpx2cron
```

```
[root@px1-ntcb ~]# ssh px2 "ls -l /etc/cron.d/a2SITE*"
```

```
-rw-r--r-- 1 root root 0 Mar 1 21:38 /etc/cron.d/a2SITEpx2cron
```

```
[root@dx1-ntcb cron.d]# ls -ld /etc/cron.d
```

```
drwxr-xr-x 2 root root 4096 Mar 23 21:32 /etc/cron.d
```

```
[root@dx1-ntcb cron.d]# touch /etc/cron.d
```

```
[root@dx1-ntcb cron.d]# ls -ld /etc/cron.d
```

```
drwxr-xr-x 2 root root 4096 Mar 29 17:05 /etc/cron.d
```

```
[root@px1-ntcb ~]# ssh px2 "ls -l /etc/ha.d/cron.d/a2SITE*"
```

```
-rw-r--r-- 1 root root 256 Feb 22 19:41 /etc/ha.d/cron.d/a2SITEpx1cron
```

```
-rw-r--r-- 1 root root 0 Feb 22 19:41 /etc/ha.d/cron.d/a2SITEpx2cron
```

## Modifying LS SITEs Crons

The following example shows the normal LS configuration. Because only one LS is active at any time, there is only one site cron, "SITEscron." The cron is synchronized between `ls2/ls3 /etc/ha.d/cron.d/` and copied to `/etc/cron.d` on the active server.

```
[root@ls2-ntcb ~]# hb_stat
```

```
Heartbeat Status Monitor
```

```
Mar 14 15:49:33
```

```
===== M e m b e r   S t a t u s =====
```

Member	Status	IP address
ls2-ntcb	Up	192.168.1.11
ls3-ntcb	Up	192.168.1.12

```
===== R e s o u r c e   S t a t u s =====
```

Resource	Parameters	Owner	Status	Start Time
IPaddr2	192.168.1.10/24/eth0	ls2-ntcb	Running OK	2011-01-14 19:32:05
LS1IPSRCaddr		ls2-ntcb	OK	2011-01-14 19:32:05
apache		ls2-ntcb	Running OK	2011-01-14 19:32:07
csportd		ls2-ntcb	CSPORTD	2011-01-14 19:32:17
Xinetd	wu_ftp	ls2-ntcb	Running OK	2011-01-14 19:32:18
hylafax		ls2-ntcb	OK	2011-01-14 19:32:18
ldad		ls2-ntcb	Starting	2011-01-14 19:32:19
dserver		ls2-ntcb	OK	2011-01-14 19:32:51
LDM		ls2-ntcb	OK	2011-01-14 19:33:08
Crontab	SITEscron	ls2-ntcb	OK	2011-01-14 19:33:18
Crontab	lscron	ls2-ntcb	OK	2011-01-14 19:33:19
SITEprocesses		ls2-ntcb	OK	2011-01-14 19:33:20

HylaFAX Details:

HylaFAX client-server protocol server: hfaxd (pid 3620) is running...

HylaFAX queue manager process: faxq (pid 3617) is running...

```
[root@ls2-ntcb ~]# ls -l /etc/ha.d/cron.d/SITE*
```

```
-rw----- 1 root root 330 Nov  9 2007 /etc/ha.d/cron.d/SITEscron
```

```
[root@ls2-ntcb ~]# ls -l /etc/cron.d/SITE*
```

```
-rw----- 1 root root 330 Nov  9 2007 /etc/cron.d/SITEscron
```

```
[root@ls2-ntcb ~]# ssh ls3 "ls -l /etc/ha.d/cron.d/SITE*"
```

```
-rw----- 1 root root 330 Nov  9 2007 /etc/ha.d/cron.d/SITEscron
```

```
-rwxr-xr-x 1 root root 330 Nov  9 2007 /etc/ha.d/cron.d/SITEscron.200801221903
```

### 11.1.2 Workstation Crons

AWIPS LX and XT workstations run standard linux crons from `/var/spool/cron/` and `/etc/`. See **man 8 cron**, **man 1 crontab**, and **man 5 crontab** for more information.

Crons in `/etc/daily`, `/etc/hourly`, `/etc/weekly`, and `/etc/monthly` are identical on all

AWIPS Linux workstations and servers. The /var/spool/cron/root crontab is identical across all AWIPS workstations and servers. See Table 11.1.2-1.

**Table 11.1.2-1. WFO Workstation crons**

Cron File	Cron Entry	What It Does	Frequency (Z time)	Cron Time (min, hour, day of month, month, day of week)
/var/spool/cron/fxa	startCtrlCpu.sh	Starts CPU monitor if it is not running	Every 10 minutes	0,10,20,30,40,50 * * * *
	diskUsage.pl	Creates a data page on disk usage for the FX Data Monitor	Every 10 minutes	0,10,20,30,40,50 * * * *
	cd \${LOG_DIR}/display; find . -mtime +1	Cleans out any display logs that are more than one day old twice a day (at 0047Z and 1247Z).	2 times/day 00:47 12:47	47 0,12 * * *
	breakLogDisplay	Breaks display logs daily	1 time/day 00:00	0 0 * * *
	breakLogCtrlCpu	Breaks ctrlCpu log daily	1 time/day 00:00	0 0 * * *
/var/spool/cron/ifps	clean_up.sh	Removes old IFPS logfiles and diagnostic output from programs	1 time/day 00:16	16 00 * * *
/var/spool/cron/root	logAndRemoveCoreFile.ksh	Removes core files	1 time/day 10:00	0 10 * * *
	/usr/bin/find /tmp \( ! -path '/tmp/lost+found/*' \) -xdev -type f \( -mtime +30 -o -ctime +30 \) -exec rm {} \;	Does cleanup – first day of the month	1 time/month 1 <sup>st</sup> day of the month 05:01	01 5 1 * * *
	/usr/bin/find /var/tmp -xdev -type f \( -mtime +30 -o -ctime +30 \) -exec rm {} \;	Does cleanup – first day of the month	1 time/month 1 <sup>st</sup> day of the month 05:02	02 5 1 * * *
	/usr/bin/find /var/tmp -xdev -type f -group fxalpha -mtime +1   xargs rm -f	Cleans up /var/tmp	1 time/day 07:20	20 7 * * *
	/usr/bin/find /tmp -xdev -type f -name "FXA*" -mtime +1   xargs rm -f	Cleans up /tmp FXA.* bundles	1 time/day 07:10	10 7 * * *
	/usr/bin/find /tmp -xdev -type f -name "*.PNG" -mtime +1   xargs rm -f	Cleans up /tmp *.PNG files	1 time/day 07:15	15 7 * * *
	boxktp	Gathers performance and system metrics	1 time/day 23:59	59 23 * * *
	boxstats_cleanlogs	Cleans up data logs created from boxstats performance gathering scripts	1 time/day 00:00	00 0 * * *
/var/spool/cron/root	boxallstats	Generates sar and top statistics	1 time/day 00:01	01 0 * * *
	reset-faillog.sh	--	Every minute	* * * * *

Cron File	Cron Entry	What It Does	Frequency (Z time)	Cron Time (min, hour, day of month, month, day of week)
/etc/cron.d/sysstat	root /usr/lib/sa/sa1 1 1	Runs system activity accounting tool	every 10 minutes	* / 10 * * * *
	root /usr/lib/sa/sa2 -A	Provides daily summary of process accounting	1 time/day 23:53	53 23 * * *
/etc/cron.daily (run from entry in /etc/crontab)	0logwatch	Parses system logs and creates output in /var/log	1 time/day 04:20	02 4 * * *
	logrotate	Rotates log files /var/log/wtmp /var/log/btmp	1 time/day 04:20	02 4 * * *
	makewhatis.cron	Reads all man pages and updates the whatis database	1 time/day 04:20	02 4 * * *
	mlocate.cron	Creates or updates a database of file names used by the locate command	1 time/day 04:20	02 4 * * *
	prelink	Modifies ELF shared libraries and ELF dynamically linked binaries to reduce the time needed for the dynamic linker to perform relocations at startup	1 time/day 04:20	02 4 * * *
	rpm	Creates list of rpm packages in /var/log/rpmpkgs	1 time/day 04:20	02 4 * * *
	Tmpwatch	Recursively removes files that have not been accessed for a given number of hours.	1 time/day 04:20	02 4 * * *
/etc/cron.weekly (run from entry in /etc/crontab)	makewhatis.cron	Reads all man pages and writes a line in the whatis database1 time/day 04:20 consisting of the name of the man page and a short description	1 time/week on Sunday at 04:22	22 4 * * 0

### 11.1.3 DX Crons

The DX servers run standard crons on all servers but only dx1 and dx2 run HA crons. The dx3 and dx4 are edex clusters (not failover clusters) that use quartz to run time based jobs compiled into edex.

#### 11.1.3.1 WFO DX Standard Crons

The DX standard crons run when the machine is up and are not part of the HA failover packages or the EDEX cluster quartz schedule. The dx1 is the NIS master and runs ypmake 2 times an hour to keep the /etc/passwd file on dx1 in synch with the NIS

password file. This is the only entry in `dx1 /var/spool/cron/root` that is different from the AWIPS workstations and servers. See Table 11.1.3.1-1.

**Table 11.1.3.1-1. WFO DX Standard crons**

Cron File	Cron Entry	What It Does	Frequency (Ztime)	Cron Time (min, hour, day of month, month, day of week)
/var/spool/cron/root (DX1 only)	/var/yp/ypmake	Remakes NIS maps if needed and push to NIS client servers	2 times/day 08:00, 20:00	0 8,20 * * *
	/bin/cp -f /var/yp/ypmake.log /var/yp/ypmake.log.old; /bin/cp -f /dev/null /var/yp/ypmake.log	Copies current ypmake.log to ypmake.old then zero out current ypmake.log	1 time/day 07:00	0 7 * * *
/var/spool/cron/root (DX1 and DX2)	logAndRemoveCoreFile.ksh	Removes core files	1 time/day 10:00	0 10 * * *
	/usr/bin/find /tmp \( ! -path '/tmp/lost+found/*' \) -xdev -type f \( -mtime +30 -o -ctime +30 \) -exec rm {} \;	Does cleanup – first day of the month	1 time/month 1 <sup>st</sup> day of the month 05:01	01 5 1 * *
	/usr/bin/find /var/tmp -xdev -type f \( -mtime +30 -o -ctime +30 \) -exec rm {} \;	Does cleanup – first day of the month	1 time/month 1 <sup>st</sup> day of the month 05:02	02 5 1 * *
	/usr/bin/find /var/tmp -xdev -type f -group fxalpha -mtime +1   xargs rm -f	Cleans up /var/tmp	1 time/day 07:20	20 7 * * *
	/usr/bin/find /tmp -xdev -type f -name "FXA*" -mtime +1   xargs rm -f	Cleans up /tmp FXA.* bundles	1 time/day 07:10	10 7 * * *
	/usr/bin/find /tmp -xdev -type f -name "*.PNG" -mtime +1   xargs rm -f	Cleans up /tmp *.PNG files	1 time/day 07:15	15 7 * * *
/var/spool/cron/root (DX1 and DX2)	boxktp	Gathers performance and system metrics	1 time/day 23:59	59 23 * * *
	boxstats_cleanlogs	Cleans up data logs created from boxstats performance gathering scripts	1 time/day 00:00	00 0 * * *
	boxallstats	Generates sar and top statistics	1 time/day 00:01	01 0 * * *
	removeArchives	Compress and purge old logs: /awips/ops/logs -r 7>> /awips/ops/logs/removeArchives.log 2>&1	29 mins past the hour	9 0 * * *
/etc/cron.d/sysstat/	root /usr/lib/sa/sa1 1 1	Runs system activity accounting tool	every 10 minutes	*/10 * * * *
	root /usr/lib/sa/sa2 -A	Generates daily summary of	1 time/day	53 23 * * *

Cron File	Cron Entry	What It Does	Frequency (Ztime)	Cron Time (min, hour, day of month, month, day of week)
		process accounting	23:53	
/etc/cron.daily (run from entry in /etc/crontab)	0logwatch	Parses system logs and creates output in /var/log	1 time/day 04:20	02 4 * * *
	logrotate	Rotates log files /var/log/wtmp /var/log/btmp	1 time/day 04:20	02 4 * * *
	makewhatis.cron	Reads all man pages and updates the whatis database	1 time/day 04:20	02 4 * * *
	mlocate.cron	Creates or updates a database of file names used by the locate command	1 time/day 04:20	02 4 * * *
	prelink	Modifies ELF shared libraries and ELF dynamically linked binaries to reduce time needed for dynamic linker to perform relocations at startup	1 time/day 04:20	02 4 * * *
	rpm	Creates list of rpm packages in /var/log/rpmpkgs	1 time/day 04:20	02 4 * * *
	tmpwatch	Recursively removes files that have not been accessed for a given number of hours.	1 time/day 04:20	02 4 * * *
/etc/cron.weekly (run from entry in /etc/crontab)	makewhatis.cron	Reads all man pages and writes a line in the whatis database consisting of the name of the man page and a short description	1 time/week on Sunday at 04:22	22 4 * * 0

### 11.1.3.2 WFO dx1f HA Crons

Two cronfiles are active in /etc/cron.d/ when the dx2f a2dx2apps package is running. One cronfile – a2SITEdx2cron – is for site-specific crons; the other – a2dx2cron – is for the baseline-delivered crons. See Table 11.1.3.2-1.

**Table 11.1.3.2-1. WFO dx1f HA crons**

Cron File	Cron Entry	What It Does	Frequency (Z time)	Cron Time (min, hour, day of month, month, day of week)
a2SITEdx1cron	Site specific	Site specific	N/A	N/A
a2dx1cron (root entries)	backup_pgdb_a2 -a	Performs daily pg_dump backup of databases	1 time/day 22:50	05 22 * * *
	backup_pgdb_a2 -d metadata	More frequent backups of metadata	Every 4 hours, skipping 22z	10 1,5,9,13,17 * * *
	nas_backup_daily	Makes full tar backups of certain files/directories	1 time/day 02:10	10 2 * * *
	/usr/bin/find /home/*/ .gnome -type f -name ".gnome-smproxy*" -mtime	Removes user gnome files older than 30 days every	1 time/week Every Sunday at	35 2 * * 0



Cron File	Cron Entry	What It Does	Frequency (Z time)	Cron Time (min, hour, day of month, month, day of week)
	+30 -exec rm -f {} \;	Sunday	02:35	
	/usr/bin/find home/*/ .sawfish/sessions -type f -mtime +30 -exec rm -f {} \;	Removes user sawfish files older than 30 days every Sunday	1 time/week Every Sunday at 02:40	40 2 * * 0
	msg_cleanup	Performs MHS Purge/Cleanup	1 time/day 07:20	2 7 * * *
	arch_cleanup_mhs	Cleans up archive MHS files	Every 30 minutes	30 * * * *
	purge_old_files	Purges old files from /var/spool/mqueue	Every 30 minutes	30 * * * *
	/awips/wdv/wdv --mode=control	Warning Dissemination Verification system monitors warning products disseminated from a site, and cross-references what is received from the SBN downlink within a reasonable period of time to ensure the product was uplinked.	Every 5 minutes	00,05,10,15,20,25,30,35,40,45,50,55 * * * *
(fxa entries)	NWWSKeepAliveMsg	Tests uplink status	4 times/hour :13, :28, :43, :58	13,28,43,58 * * * *
	startScour	Scours daily to clean up log files and a few items not hit by master.purge	1 time/day 00:30	30 0 * * *
	breakLogIngest	Breaks ingest logs daily	1 time/day 00:00	0 0 * * *
	nwrWatchDog.sh	Restarts nwrTrans.pl if necessary	Every minute	* * * * *
	NWRWAVESpurge.sh	Cleans DEBUG LOGS OUTPUT INPUT and TEST Directories	1 time/day 00:45	45 0 * * *
(fxa entries)	removeExpiredNWR.sh	Removes any expired or corrupt files from pending and sent side of NWRWAVESBrowser	2 times/hour :20, :40	20,40 * * * *
	updateSUMMARY.csh	Updates the summary message four times an hour	4 times/hour :00, :15, :30, :45	00,15,30,45 * * * *
	pendingDirCheck	Checks for old messages in the pending directory every ten minutes	Every 10 minutes	00,10,20,30,40,50 * * * *
	legalArchiver.sh	Archives Observations and Official User Products text files; purges obs product files older than 7 days, and OUP files older than 31 days	1 time/hour :55	55 * * * *

Cron File	Cron Entry	What It Does	Frequency (Z time)	Cron Time (min, hour, day of month, month, day of week)
(oper entries)	run_hg_history	Generates XML file containing crests, low-water events, and impacts	1 time/day 01:01	1 1 * * *

### 11.1.3.3 WFO dx2f HA Crons

Two cronfiles are active in /etc/cron.d/ when the dx2f a2dx2apps package is running: a2SITEdx2cron is for site-specific crons; and a2dx2cron is for the baseline-delivered crons. See Table 11.1.3.3-1.

**Table 11.1.3.3-1. WFO dx2f HA crons**

Cron File	Cron Entry	What It Does	Frequency (Z time)	Cron Time (min, hour, day of month, month, day of week)
a2SITEdx1cron	Site specific	Site specific	N/A	N/A

### 11.1.4 PX Crons

The PX servers run crons for standard Linux and for HA clusters. The px1f and px2f crons are maintained in /etc/ha.d/cron.d on both px1 and px2. When the HA packages start up, the appropriate crons are copied to /etc/cron.d and activated.

#### 11.1.4.1 WFO PX Standard Crons

The PX standard crons run when the machine is up (running) and are not part of the HA failover packages. The PX standard crons are different from the workstations and the DX. See Table 11.1.4.1-1.

**Table 11.1.4.1-1. WFO PX Standard crons**

Cron File	Cron Entry	What It Does	Frequency (Z time)	Cron Time (min, hour, day of month, month, day of week)
/var/spool/cron/root	logAndRemoveCoreFile.ksh	Removes core files	1 time/day 10:00	0 10 * * *
	boxktp	Gathers performance and system metrics	1 time/day 23:59	59 23 * * *
	boxstats_cleanlogs	Cleans up data logs created from boxstats performance gathering scripts	1 time/day 00:00	00 0 * * *
	boxallstats	Generates sar and top statistics	1 time/day 00:01	1 0 * * *

Cron File	Cron Entry	What It Does	Frequency (Z time)	Cron Time (min, hour, day of month, month, day of week)
/etc/cron.d/sysstat	root /usr/lib/sa/sa1 1 1	Runs system activity accounting tool	Every 10 minutes	* / 10 * * * *
	root /usr/lib/sa/sa2 -A	Provides daily summary of process accounting	1 time/day 23:53	53 23 * * *
/etc/cron.daily (run from entry in /etc/crontab)	0logwatch	Parses system logs and creates output in /var/log	1 time/day 04:20	02 4 * * *
	logrotate	Rotates log files /var/log/wtmp /var/log/btmp	1 time/day 04:20	02 4 * * *
	makewhatis.cron	Reads all man pages and updates the whatis database	1 time/day 04:20	02 4 * * *
	mlocate.cron	Creates or updates a database of file names used by the locate command	1 time/day 04:20	02 4 * * *
	prelink	Modifies ELF shared libraries and ELF dynamically linked binaries to reduce the time needed for the dynamic linker to perform relocations at startup	1 time/day 04:20	02 4 * * *
/etc/cron.daily (run from entry in /etc/crontab)	rpm	Creates list of rpm packages in /var/log/rpmpkgs	1 time/day 04:20	02 4 * * *
	tmpwatch	Recursively removes files which haven't been accessed for a given number of hours	1 time/day 04:20	02 4 * * *
/etc/cron.weekly (run from entry in /etc/crontab)	makewhatis.cron	Reads all man pages and writes a line in the whatis database consisting of the name of the man page and a short description	1 time/week on Sunday at 04:22	22 4 * * 0

#### 11.1.4.2 WFO px1f HA Crons

Two cronfiles are active in /etc/cron.d/ when the px1f a2px1apps package is running: a2SITEpx1cron is for site-specific crons; and a2px1cron is for the baseline-delivered crons. See Table 11.1.4.2-1.

Table 11.1.4.2-1. WFO px1f HA crons

Cron File	Cron Entry	What It Does	Frequency (Z time)	Cron Time (min, hour, day of month, month, day of week)
a2SITEpx1cron	Site specific	Site specific	--	--
a2px1cron (fxa entries)	breakLogIngest	Breaks ingest logs daily	1 time/day 00:00	0 0 * * *
	breakAnnouncementFiles	Breaks announcer files daily	1 time/day 00:00	0 0 * * *
	master.purge	Performs master purger daily, to clean out old log directories	1 time/day 01:30	30 1 * * *
	startScour	Scours daily to clean up log files and a few items not hit by master.purge	1 time/day 00:30	30 0 * * *
	climate.sh auto am	Morning Climate (MDL)	1 time/day 12:25	25 12 * * *
	climate.sh auto pm	Evening Climate (MDL)	1 time/day 22:25	25 22 * * *
a2px1cron (fxa entries)	launch_AEV.csh Mtr_scd_dvr	Controls the MTR decoder feeding Climate (MDL)	Every hour at :07	7 * * * *
	clean_FSS_tables.sh	Purges the MTR decoder tables about once a week (MDL)	1 time/week every week at 03:40	40 3 1,8,15,22 * *
	hwrnwr -t	NOAA Weather Radio HWR	Every hour at :10	10 * * * *
	hwrnwws -t	NWWS HWR	Every hour at :10	10 * * * *
	awips2_radarIngest.pl	LAPS Ingest radar	Roughly every 5 minutes	05,10,15,19,25,30,35,40,45,50,55 * * * *
	awips2_satIngest.pl	LAPS Ingest satellite	Every 15 minutes	12,17,42,57 * * * *
	sched.pl	LAPS – runs LAPS analyses	Every hour at :20	20 * * * *
	startPurgeProcess	Keeps purgeProcess running	Every 10 minutes	*/10 * * * *
	WFOA_MSAS_Sfcnmc.run	MSAS Ingest the NCEP surface grids every 6 hours	Every 6 hours at :35	35 5,11,17,23 * * *
	WFOA_MSAS_Surface.run	MSAS Run the surface cycle 4 times an hour	4 times/hour at :11, :26, :41, :56	11,26,41,56 * * * *
	WFOA_MSAS_Asos.run	MSAS Compile the daily surface QC stats	1 time/day 00:05	5 0 * * *
	WFOA_MSAS_QCstage1_2.run	QCMS stage 1 & 2 QC on current hour's data	12 times/hour	1,6,11,16,21,26,31,36,41,46,51,56 * * * *
	WFOA_MSAS_QCstage1_2_late.run	QCMS stage 1 & 2 QC on previous hour's data	12 times/hour	1,6,11,16,21,26,31,36,41,46,51,56 * * * *
	WFOA_MSAS_QCday.run	QCMS yesterday's QC stage 1, 2 & 3 daily summaries	1 time/day at 01:15	15 1 * * *

Cron File	Cron Entry	What It Does	Frequency (Z time)	Cron Time (min, hour, day of month, month, day of week)
(oper entries)	purge_files	Purges WHFS UNIX files	Every 4 hours at :01	01 1,5,9,13,17,21 * * *
	purge_mpe_files	Purges WHFS mpe files	1 time/day at 12:01	01 12 * * *
	run_floodseq	Updates flood history for hydro database	1 time/day at 06:30	30 6 * * *
	run_mpe_whfs	Set of programs that completes mpe analysis	1 time/hour at :24	24 * * * *
	process_qpe_mosaic	WFOs only - grib encodes the RFC QPE mosaics and sends them to awips for display	4 times/hour at :05, :20, :35, :50	05,20,35,50 * * * *
	purge_hpe_files	Purges HPE files according to retention period	Every 30 minutes	8,38 * * * *
	run_SSHP_HP_N_preprocess	SSHP HPN Preprocessor	1 time/hour at :06	06 * * * *
	run_SSHP_var	Variational Data Assimilation for SAC-SMA model in SSHP [Note: Uncomment this cron entry line if your office is using VAR within SSHP.]	1 time/hour at :30 (if uncommented)	#30 * * * *
	run_SSHP_SAC_state_update	Runs SSHP in background for RiverMonitor's SSHP fest columns.	1 time/hour at :36 (if uncommented)	#36 * * * *
	run_hg_genXML	Creates XML hydrograph data files for use by web applications	4 times/hour :09, :24, :39, :54	9,24,39,54 * * * *
(root entries)	VIRtest	Performs VIR test 3 times/day	3 times/day 02:15, 10:15, 18:15	15 2,10,18 * * *
	startPurgeProcess	Starts purgeProcess if it is not running	Every 10 min	*/10 * * * *

### 11.1.4.3 WFO px2f HA Crons

Two cronfiles are active in /etc/cron.d/ when the px2f a2px2apps package is running: a2SITEpx2cron is for site-specific crons; and a2px2cron is the baseline delivered crons. See Table 11.1.4.3-1. Note: The Localization cron is added back to px2f archiver cron. It launches Localization.tcl once a day at 7z.

**Table 11.1.4.3-1. WFO px2f HA crons**

Cron File	Cron Entry	What It Does	Frequency (Z time)	Cron Time (min, hour, day of month, month, day of week)
a2SITEpx2cron	BOIVerify and Site specific	BOIVerify and Site specific	N/A	N/A
a2px2cron (fxa entries)	startScour	Scours daily to clean up log files and a few items not hit by master.purge	1 time/day 00:30	30 0 * * *
	breakLogIngest	Breaks ingest logs daily	1 time/day 00:00	0 0 * * *
(ldad entry)	breakLogLDAD.px2	Breaks ingest and decoder logs daily at 00Z	1 time/day 00:00	0 0 * * *
(root entries)	gatherLogs.pl	Collects system log files from several hosts	1 time/day 07:23	23 7 * * *
	/usr/local/bin/scp -q ls1:/home/securityLogs/* /home/securityLogs	Copies the Security Logs from ls1 to px2	1 time/day 07:34	34 7 * * *
	logAndRemoveCoreFile. Ksh	Removes core file from /home on an hourly basis at 10 past the hour	Every 10 minutes	10 * * * *

### 11.1.5 WFO LS Crons

The LS servers run crons for both standard Linux and for the LS HA cluster. The LS crons are maintained in /etc/ha.d/cron.d on both ls2 and ls3. When the HA package is up, the appropriate crons are copied to /etc/cron.d and activated.

#### 11.1.5.1 WFO LS Standard Crons

The LS standard crons run when the machine is up; they are not part of the HA failover package. See Table 11.1.5.1-1.

**Table 11.1.5.1-1. WFO LS Standard Crons**

Cron File	Cron Entry	What It Does	Frequency (Z time)	Cron Time (min, hour, day of month, month, day of week)
/var/spool/cron/root	No entries	Site Specific	N/A	N/A
/var/spool/cron/ldad	startScour.sh	Runs scour daily to clean up log files	1 time/day 00:30	30 0 * * *
/etc/cron.d/sysstat	root /usr/lib/sa/sa1 1 1	Runs system activity accounting tool	Every 10 minutes	*/10 * * * *
	root /usr/lib/sa/sa2 -A	Runs daily summary of process accounting	1 time/day 23:53	53 23 * * *

#### 11.1.5.2 WFO LS HA Crons

Two cronfiles are active when the LS HA package is running: SITElscron is for site-specific crons; and lscron is the baseline delivered crons. See Table 11.1.5.2-1.

**Table 11.1.5.2-1. WFO LS HA Crons**

Cron File	Cron Entry	What It Does	Frequency (Z time)	Cron Time (min, hour, day of month, month, day of week)
SITElscron	Site specific	Site specific	N/A	N/A
lscron (ldad entry)	breakLogLDAD.ls	Breaks LDAD logs daily at 00Z	1 time/day 00:00	0 0 * * *
(root entries)	rsync_cron.sh data_ldad	sync /data/ldad directory	1 time/hour at :10	10 * * * *
	rsync_cron.sh ldm	sync /usr/local/ldm/data/ directory	2 times/day 06:20, 12:20	20 6,12 * * *
	rsync_cron.sh home	sync /home directory	1 time/day 23:01	01 23 * * *

### 11.1.6 WFO CSPBN Crons

The CPSBN servers run standard crons. See Table 11.1.6-1.

**Table 11.1.6-1. WFO CPSBN crons**

Cron File	Cron Entry	What It Does	Frequency (Z time)	Cron Time (min, hour, day of month, month, day of week)
/var/spool/cron/root	removeArchives	Removes old monitor and control archives	1 time/day 00:09	9 0 * * *
/etc/cron.d/sysstat	root /usr/lib/sa/sa1 1 1	Runs system activity accounting tool	Every 10 minutes	*/10 * * * *
	root /usr/lib/sa/sa2 -A	Runs a daily summary of process accounting	1 time/day 23:53	53 23 * * *
a2cp1cron (ldm entries)	ldmadmin scour	Scours data directories	Every 3 hours at :00	0 */3 * * *
	ldmadmin newlog	Rotates log file	1 time/day 00:00	0 0 * * *

A qpid monitoring script takes snapshots of qpid status and other system-level statistics in order to monitor their health related to qpid in the event that issues arise related to qpid. The cron runs every 10 minutes on cp1f (it is part of a2cp1cron). The script collects qpid information and stores it in /data/fxa/qpid. It keeps one week's worth of data.

```
*/10 * * * * root sh -lc "/awips2/python/bin/monitor_qpid_host.sh"
```

### 11.1.7 WFO AX Crons

The AX server runs standard crons. See Table 11.1.7-1.

**Table 11.1.7-1. WFO AX Crons**

Cron File	Cron Entry	What It Does	Frequency (Z time)	Cron Time (min, hour, day of month, month, day of week)
/var/spool/cron/root	logAndRemoveCoreFile.ksh	Removes core files	1 time/day 10:00	0 10 * * *
	boxktp	Gathers performance and system metrics	1 time/day 23:59	59 23 * * *
	boxstats_cleanlogs	Cleans up data logs created from boxstats performance gathering scripts	1 time/day 00:00	00 0 * * *
	boxallstats	Generates sar and top statistics	1 time/day 00:01	1 0 * * *
	nas_backup_weekly	Backs up all volumes on the NAS on a weekly basis	1 time/week (every Monday at 03:10)	10 3 * * 1
/var/spool/cron/fxa	startCtrlCpu.sh	Starts CPU monitor if it is not running	Every 10 minutes	0,10,20,30,40,50 * * * *
	startScour	Runs scour daily to clean up log files and a few items not hit by other purgers	1 time/day 00:30	30 0 * * *
	breakLogCtrlCpu	Breaks ctrlCpu log daily	1 time/day 00:00	0 0 * * *
/etc/cron.d/sysstat	root /usr/lib/sa/sa1 1 1	Runs system activity accounting tool	Every 10 minutes	*/10 * * * *
	root /usr/lib/sa/sa2 -A	Runs daily summary of process accounting	1 time/day 23:53	53 23 * * *

### 11.1.8 Archiver Crons

Archiver Retention is the management of data deletion (purging) from the file system. It is defined by configuration files stored in the EDEX Localization subsystem. The configurations can be edited through the Archive Retention Dialog, accessible through the menu CAVE > Archive Retention..., or manually (not recommended) by editing the XML configuration file through the CAVE Localization Perspective.

The Archive Purger is run by a quartz cron timer. This timer is a configurable property in the /awips2/edex/conf/resources/com.raytheon.uf.edex.archive.cron.properties file,

**archive.purge.cron=0+5+0/3+\*+\*+?**

This is the delivered baseline value, which configures it to run once every three hours at 5 minutes after the hour, starting at midnight.

Data copied to the archive folder is quartz cron timer configurable property,

**archive.cron=0+40+\*+\*+\*+?**

This is the delivered baseline value, which configures it to run once every hour at 40 minutes after the hour. Copying the data to the archive folder can be disabled by changing the property,



**archive.enable=true**

**Note 1:** EDEX will need to be restarted before any change in property values in the `com.raytheon.uf.edex.archive.cron.properties` file will take effect.

**Note 2: Note:** `cron.properties` and `architecture.properties` have been broken out in to the individual plugins that need the properties in `/awips2/edex/conf/resources`. Previously changes to these files would be blown away at install time and there was no way for site to override. Sites may now override any properties by creating a `.properties` file in `/awips2/edex/conf/resources/site/XXX` on both dx3 and dx4. Files are incrementally overridden.

**11.2 quartz**

EDEX essentially consists of a collection of components that execute in response to events. A “quartz”-driven event is one type of event available in EDEX. quartz provides a cron-like facility inside EDEX.

- quartz is part of EDEX, and is only used as part of EDEX. This means that quartz is only used on DX3/4, and that quartz-controlled jobs execute only while EDEX is running. EDEX does coordinate between DX3 and DX4, however. This means quartz-controlled jobs will run as long as EDEX is running on at least one of DX3 and DX4.
- quartz does not log to `/var/log/cron`. quartz errors will log to the appropriate EDEX process log. Jobs controlled by quartz may provide their own logging.
- quartz entries are compiled into EDEX; sites are not able to modify or view quartz entries.

Quartz jobs are scheduled to run when a given Trigger occurs. Triggers can be created with nearly any combination of the following directives:

- At a certain time of day (to the millisecond)
- On certain days of the week
- On certain days of the month
- On certain days of the year
- Not on certain days listed within a registered Calendar (such as business holidays)
- Repeated a specific number of times
- Repeated until a specific time/date
- Repeated indefinitely
- Repeated with a delay interval.

When quartz “fires,” an event is sent to the EDEX component. A quartz event can be configured to fire using the same basic expression as cron.

For example, EDEX uses a quartz trigger to run a periodic data purge. In the descriptor for the purge service, the Uri for the event source is

**"quartz://purge/purge Scheduled/?cron=0+15+\*+\*+\*+?"**.

This is equivalent to a cron expression of 15 \* \* \* \* — that is, quartz fires 15 minutes after every hour. AWIPS II EDEX contains a number of quartz event components that must perform periodic tasks like this.

As a result, many of the crons that are used in AWIPS I have become quartz event-driven EDEX components in AWIPS II.

A list of cron jobs and associated schedules for AWIPS II is provided in Table 11.2-1.

**Table 11.2-1. Crons Jobs and Associated Schedules for AWIPS II**

Plug-In	Cron	Fires	Configuration	Comment
com.raytheon.edex.autobldsrv	0+*+*+*+*+?	Every minute	Subscription table in DB	Runs cron-based script runner
com.raytheon.edex.plugin.gfe	0+15+*+*+*+?	15 mins. after each hour	Normal localization	--
	0+10+*+*+*+?	10 mins. after each hour	Normal install/localization	Part of service backup
com.raytheon.edex.rpgenvdata	0+0+*+*+*+?	On the hour, every hour	Normal localization	--
	0+26,46+*+*+*+?	26 and 46 mins. after each hour	Normal localization	--
com.raytheon.uf.edex.distribution	0/5+*+*+*+*+?	Every 5 seconds	Distribution files	Refreshes data distribution rules
com.raytheon.uf.edex.metartohmdbsrv	0+14+*+*+*+?	At 14 mins. after each hour	Non configurable	Runs the HMDB purge
com.raytheon.uf.edex.ohd	0+7,17,27,37,47,57+*+*+*+?	7, 17, 27, 37, 47, and 57 mins. after each hour	Normal localization	Runs the WHFS alarms service
	0+20+0,6,12,18+*+*+*+?	At 0:20, 6:20, 12:20 18:20 daily	Normal localization	Runs DQC pre processor
	0+30+6+*+*+*+?	At 6:30 each day	Normal localization	Runs flood sequence service
	0+45+7+*+*+*+?	At 7:45 each day	Normal localization	Runs the IHFS database purge
	0+1+1,5,9,13,17,21+*+*+*+?	At 1:01, 5:01, 9:01, 13:01, 17:01, 21:01daily	Normal localization	runs scheduled log file purger
	0+25+*+*+*+*+?	25 minutes after each hour	Normal localization	Runs the hourly MPE
	0+1+12+*+*+*+?	At 12:01 daily	Normal localization	Runs the HPE file purger
	0+2,17,32,47+*+*+*+*+?	2, 17, 32, and 47 mins. after each hour	Normal localization	Runs the WHFS services
com.raytheon.uf.edex.plugin.acarssounding	0+10,30,50+*+*+*+*+?	10, 30, and 50 mins. after every hour	Normal localization	Runs acars sound processing
com.raytheon.uf.edex.purgesrv	0+15+*+*+*+*+?	At 15 mins. after each hour	Purge times in DB	Runs the basic data store purge

### 11.3 EDEX Log File Purging

Log purging is designed to reduce the space required for EDEX logs. In operation it will:

- Zip any log files that are more than 7 days old into a date stamped log file.
  - Only files that match the “standard” log naming pattern are zipped.
    - File name pattern is “`^(.*)(\d{4}\d{2}\d{2})(.*)\.log$`”.
    - Name contains an 8 digit number and ends in “.log”.
    - Although not required, the 8 digits represent YYYYMMDD.
  - The files that have been zipped are removed from the logs directory.
- Remove any zip files that are more than one month old.
  - File name pattern is “`^(d{4}\d{2}\d{2})\.zip$`”.
  - Name is 8 digit followed by “.zip”.
    - Although not required, the 8 digits represent YYYYMMDD.

#### Purge timing:

The log purge fires at 00:30 each day.

#### Configuration:

The log purge can be rescheduled by modifying its *quartz* timer trigger value in `project.properties`. `project.properties` is located in `/awips2/edex/conf/spring`. The token value to change is “`purge.logs.cron`”. The default setting for this token is

```
purge.logs.cron=0+30+0+*+*+*+?
```

This specifies that the log purge will fire at 00:30 every day.

#### Event logging:

Log purging events are logged to both the EDEX Ingest and EDEX Ingest Purge logs.

#### Purge events:

```
PurgeLogger: EDEX: EDEX - -----START LOG PURGE-----
PurgeLogger: EDEX: EDEX - Removed 0 old files
PurgeLogger: EDEX: EDEX - Archived 0 files
PurgeLogger: EDEX: EDEX - Skipped processing 0 files
PurgeLogger: EDEX: EDEX - -----END LOG PURGE-----
```

#### Comments:

This is a somewhat generic zipper/purger and can handle logs other than the standard EDEX logs. The main catch is that the log name must contain an embedded 8-digit number and end “.log”. Files not matching this pattern are simply ignored.

The caveat: File name patterns and retention times are coded in and cannot be changed.

### 11.4 Verifying WFO Raw Data Storage and Archive Purging

Purging of raw data (/data\_store), hdf5 data (dx2f: /awips2/edex/data/hdf5/), and archive data for WES2 case generation (/archive) is performed through EDEX quartz entries on timed and triggered events. EDEX purge actions are logged to **/awips2/edex/logs/edex-ingest-purge-<YYYYMMDD>.log**.

Raw data	The <b>/awips2/edex/conf/resources/com.raytheon.uf.edex.archive.cron.properties</b> file controls values for purging raw data in data_store.
Archive data	The <b>/awips2/edex/conf/resources/com.raytheon.uf.edex.archive.cron.properties</b> file contains values for turning purging on/off and moving data to /archive and for the archive purge.
HDF5 data	The <b>/awips2/edex/conf/spring/cron.properties</b> file contains values for purging data in the hdf5 data store. The purge xml files in <b>/awips2/edex/data/utility/common_static/base/purge</b> and <b>/awips2/edex/data/utility/common_static/site/&lt;SITE&gt;/purge</b> control the number of versions of a product to keep.
Log data	The <b>/awips2/edex/conf/spring/cron.properties</b> file contains values for purging EDEX log files.

Scheduled purge events:

:00	Regular purge of hdf5 and metadata database.
:05	Archive purge of /archive and /data_store (every 2 hours). Replaces LDM scour.
:20	h5repack – internally compress point hdf files
:40	dbArchiver – populates archive stage for any file created or updated in the previous hour.

#### 1. Verify purging of raw data (/data\_store).

Purging of the AWIPS II Raw Data Store is no longer managed by the LDM scour process. Raw Data Store purging is now managed by a quartz job on the dx3/dx4 edex cluster. The xml file for this purge can be viewed from the Localization perspective of CAVE under the Archive – RAW\_DATA.xml tabs.

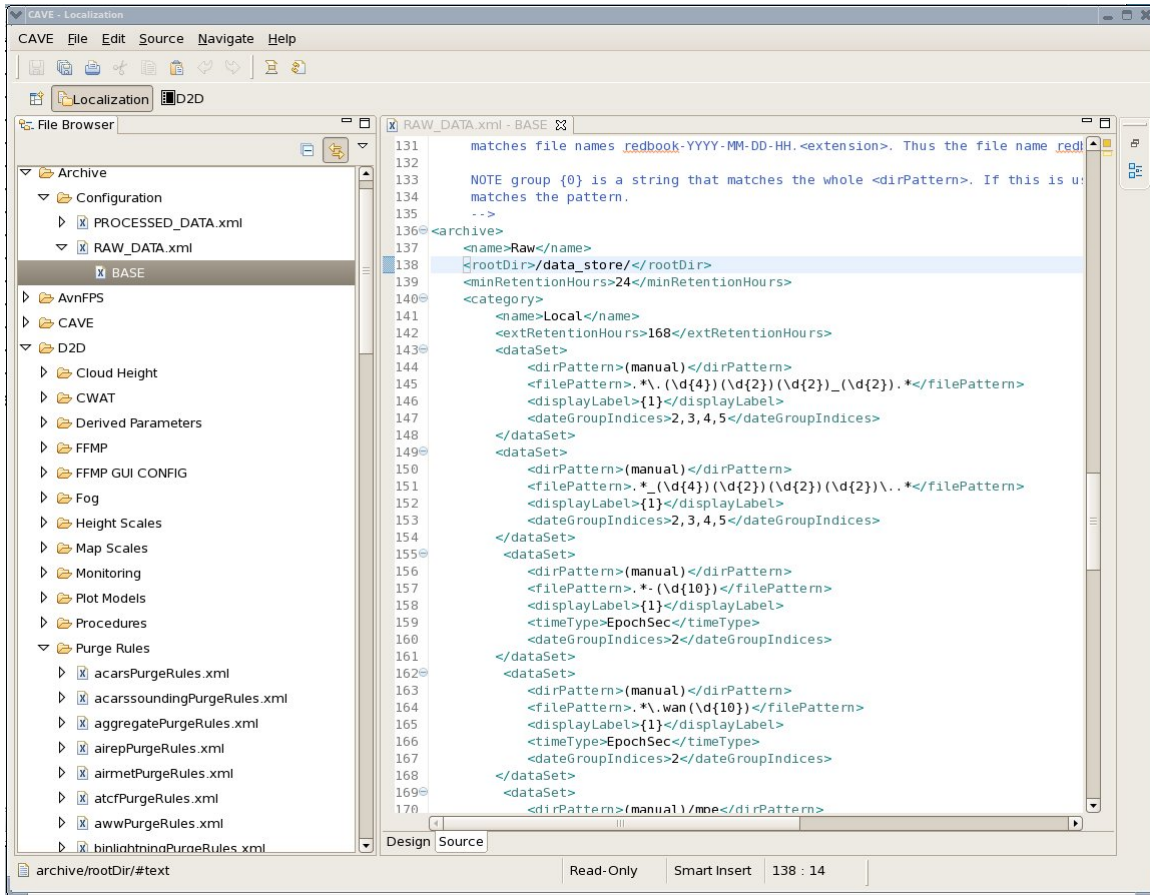

This file can be viewed from the command line, but modifications should occur through the Localization Perspective using a SITE copy override of the BASE xml file.

```
ssh dx3
cd /awips2/edex/data/utility/common_static/base/archiver/purger
ls
```

```
dx1-ntca{rschup}108: ssh dx3

dx3-ntca{rschup}108: cd
/awips2/edex/data/utility/common_static/base/archiver/purger

dx3-ntca{rschup}109: ls
PROCESSED_DATA.xml PROCESSED_DATA.xml.md5 RAW_DATA.xml
RAW_DATA.xml.md5
```

EDEX quartz entries for purge of raw data are contained in  
/awips2/edex/conf/resources/com.raytheon.uf.edex.archive.cron.properties.

```
cat /awips2/edex/conf/resources/com.raytheon.uf.edex.archive.cron.properties
```

```
dx3-ntca{rschup}110:cat
/awips2/edex/conf/resources/com.raytheon.uf.edex.archive.cron.properties
# enable archive
archive.enable=true
# runs database and hdf5 archive for archive server to pull data from
archive.cron=0+40+*+*+*+?
# path to store processed archive data
archive.path=/archive

# enable archive purge
archive.purge.enable=true
# when to purge archives
archive.purge.cron=0+5+0/2+*+*+?
# compress database records
archive.compression.enable=false

# to disable a specific archive, use property
archive.disable=pluginName,pluginName...
#archive.disable=grid,text,acars
```

EDEX quartz purge actions of raw data are logged in `/awips2/edex/logs/edex-ingest-purge-<YYYYMMDD>.log`.

```
cd /awips2/edex/logs
```

```
grep "Purging directory:" edex-ingest-purge-<YYYYMMDD>.log
```

```
ssh dx4 "cd /awips2/edex/logs ; grep \"Purging directory:\" edex-ingest-purge-20140320.log"
```

```
[rschup@dx3-ntca logs]$ cd /awips2/edex/logs

[rschup@dx3-ntca logs]$ grep "Purging directory:" edex-ingest-purge-20140320.log
INFO 2014-03-20 00:05:00,272 [Purge-Archive] ArchiveConfigManager: EDEX - Purging directory:
"/archive".
INFO 2014-03-20 00:07:19,216 [Purge-Archive] ArchiveConfigManager: EDEX - Purging directory:
"/data_store".
INFO 2014-03-20 04:05:00,050 [Purge-Archive] ArchiveConfigManager: EDEX - Purging directory:
"/archive".
INFO 2014-03-20 04:05:24,036 [Purge-Archive] ArchiveConfigManager: EDEX - Purging directory:
"/data_store".
INFO 2014-03-20 08:05:00,052 [Purge-Archive] ArchiveConfigManager: EDEX - Purging directory:
"/archive".
INFO 2014-03-20 08:05:18,470 [Purge-Archive] ArchiveConfigManager: EDEX - Purging directory:
"/data_store".
INFO 2014-03-20 12:05:00,083 [Purge-Archive] ArchiveConfigManager: EDEX - Purging directory:
"/archive".
INFO 2014-03-20 12:07:02,898 [Purge-Archive] ArchiveConfigManager: EDEX - Purging directory:
"/data_store".
INFO 2014-03-20 16:05:00,088 [Purge-Archive] ArchiveConfigManager: EDEX - Purging directory:
"/archive".
INFO 2014-03-20 16:05:13,451 [Purge-Archive] ArchiveConfigManager: EDEX - Purging directory:
"/data_store".
[rschup@dx3-ntca logs]$

[rschup@dx3-ntca logs]$ ssh dx4 "cd /awips2/edex/logs ; grep \"Purging
directory:\" edex-ingest-purge-20140320.log"
INFO 2014-03-20 02:05:00,122 [Purge-Archive] ArchiveConfigManager: EDEX - Purging directory:
"/archive".
INFO 2014-03-20 02:05:18,364 [Purge-Archive] ArchiveConfigManager: EDEX - Purging directory:
"/data_store".
INFO 2014-03-20 06:05:00,048 [Purge-Archive] ArchiveConfigManager: EDEX - Purging directory:
"/archive".
INFO 2014-03-20 06:06:37,710 [Purge-Archive] ArchiveConfigManager: EDEX - Purging directory:
"/data_store".
INFO 2014-03-20 10:05:00,155 [Purge-Archive] ArchiveConfigManager: EDEX - Purging directory:
"/archive".
INFO 2014-03-20 10:05:34,515 [Purge-Archive] ArchiveConfigManager: EDEX - Purging directory:
"/data_store".
INFO 2014-03-20 14:05:00,237 [Purge-Archive] ArchiveConfigManager: EDEX - Purging directory:
"/archive".
INFO 2014-03-20 14:05:25,059 [Purge-Archive] ArchiveConfigManager: EDEX - Purging directory:
"/data_store".
```

Purging of a specific data type is logged in the purge log.

```
grep -i satellite edex-ingest-purge-20140320.log | grep data_store | tail -2
```

```
[rschup@dx3-ntca logs]$ grep -i satellite edex-ingest-purge-  
20140320.log | grep data_store | tail -2  
INFO 2014-03-20 16:06:19,327 [Purge-Archive] ArchiveConfigManager: EDEX - Start purge of  
category Raw - Satellite, directory "/data_store/sat".  
INFO 2014-03-20 16:06:20,762 [Purge-Archive] ArchiveConfigManager: EDEX - End purge of category  
Raw - Satellite, directory "/data_store/sat", deleted 449 files and directories.  
[rschup@dx3-ntca logs]$
```



## 2. Verify purging of WFO archive data (/archive).

Purging of archive data (/archive/) is managed by a quartz job on the dx3/dx4 edex cluster. The xml file for this purge can be viewed from the Localization perspective of CAVE under the Archive – PROCESSED\_DATA.xml tabs.

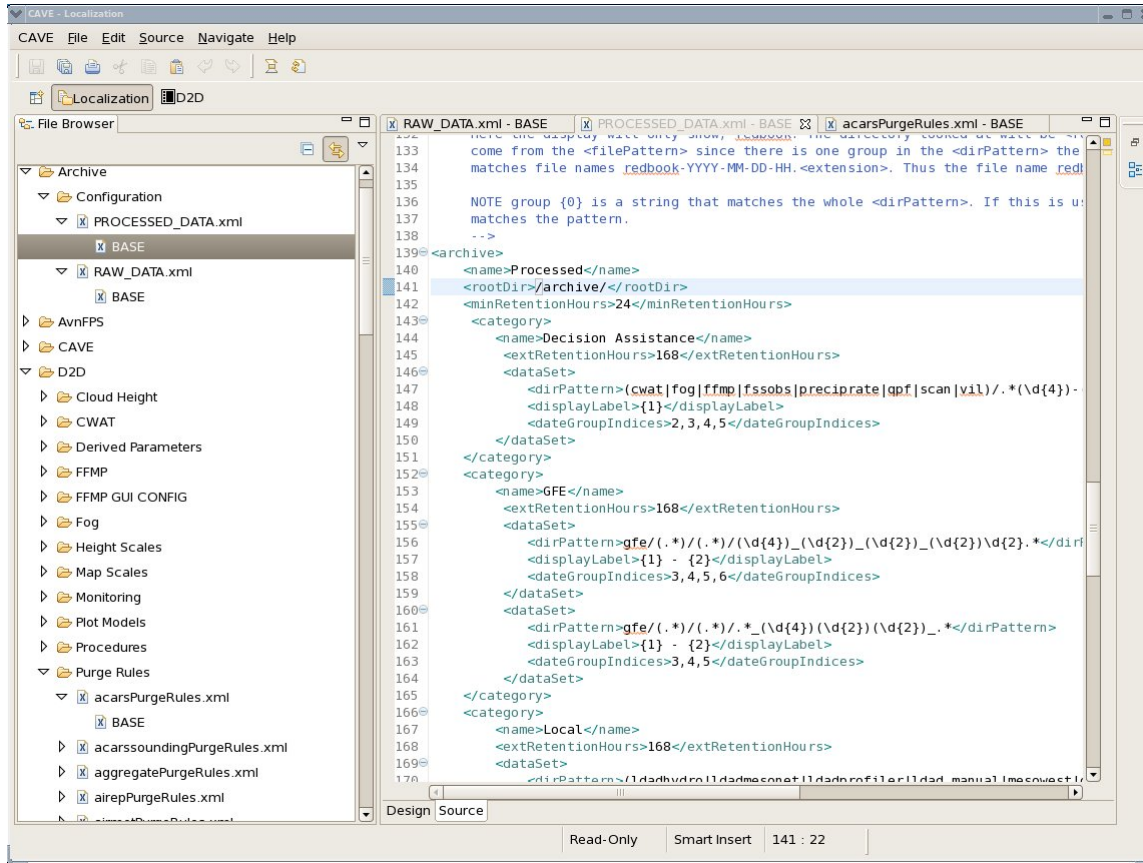

This file can be viewed from the command line, but modifications should occur through the Localization Perspective using a SITE copy override of the BASE xml file.

```
cd /awips2/edex/data/utility/common_static/base/archiver/purger
ls
```

```
dx3-ntca{rschup}108: cd
/awips2/edex/data/utility/common_static/base/archiver/purger

dx3-ntca{rschup}109: ls
PROCESSED_DATA.xml PROCESSED_DATA.xml.md5 RAW_DATA.xml
RAW_DATA.xml.md5
```

EDEX quartz entries for purge of /archive data are contained in  
**/awips2/edex/conf/resources/com.raytheon.uf.edex.archive.cron.properties.**

```
cat /awips2/edex/conf/resources/com.raytheon.uf.edex.archive.cron.properties
```

```
dx3-ntca{rschup}110: cat
/awips2/edex/conf/resources/com.raytheon.uf.edex.archive.cron.properties
# enable archive
archive.enable=true
# runs database and hdf5 archive for archive server to pull data from
archive.cron=0+40+*+*+*+*+?
# path to store processed archive data
archive.path=/archive

# enable archive purge
archive.purge.enable=true
# when to purge archives
archive.purge.cron=0+5+0/2+*+*+*+?
# compress database records
archive.compression.enable=false

# to disable a specific archive, use property
archive.disable=pluginName,pluginName...
#archive.disable=grid,text,acars
```

EDEX quartz purge actions of /archive data are logged in **/awips2/edex/logs/edex-ingest-purge-<YYMMDD>.log**.

```
cd /awips2/edex/logs
```

```
grep "Purging directory:" edex-ingest-purge-20140320.log
```

```
ssh dx4 "cd /awips2/edex/logs ; grep \"Purging directory:\" edex-ingest-purge-20140320.log"
```

```
[rschup@dx3-ntca logs]$ cd /awips2/edex/logs

[rschup@dx3-ntca logs]$ grep "Purging directory:" edex-ingest-purge-20140320.log
INFO 2014-03-20 00:05:00,272 [Purge-Archive] ArchiveConfigManager: EDEX - Purging directory:
"/archive".
INFO 2014-03-20 00:07:19,216 [Purge-Archive] ArchiveConfigManager: EDEX - Purging directory:
"/data_store".
INFO 2014-03-20 04:05:00,050 [Purge-Archive] ArchiveConfigManager: EDEX - Purging directory:
"/archive".
INFO 2014-03-20 04:05:24,036 [Purge-Archive] ArchiveConfigManager: EDEX - Purging directory:
"/data_store".
INFO 2014-03-20 08:05:00,052 [Purge-Archive] ArchiveConfigManager: EDEX - Purging directory:
"/archive".
INFO 2014-03-20 08:05:18,470 [Purge-Archive] ArchiveConfigManager: EDEX - Purging directory:
"/data_store".
INFO 2014-03-20 12:05:00,083 [Purge-Archive] ArchiveConfigManager: EDEX - Purging directory:
"/archive".
INFO 2014-03-20 12:07:02,898 [Purge-Archive] ArchiveConfigManager: EDEX - Purging directory:
"/data_store".
INFO 2014-03-20 16:05:00,088 [Purge-Archive] ArchiveConfigManager: EDEX - Purging directory:
"/archive".
INFO 2014-03-20 16:05:13,451 [Purge-Archive] ArchiveConfigManager: EDEX - Purging directory:
"/data_store".
[rschup@dx3-ntca logs]$

[rschup@dx3-ntca logs]$ ssh dx4 "cd /awips2/edex/logs ; grep \"Purging
directory:\" edex-ingest-purge-20140320.log"
INFO 2014-03-20 02:05:00,122 [Purge-Archive] ArchiveConfigManager: EDEX - Purging directory:
"/archive".
INFO 2014-03-20 02:05:18,364 [Purge-Archive] ArchiveConfigManager: EDEX - Purging directory:
"/data_store".
INFO 2014-03-20 06:05:00,048 [Purge-Archive] ArchiveConfigManager: EDEX - Purging directory:
"/archive".
INFO 2014-03-20 06:06:37,710 [Purge-Archive] ArchiveConfigManager: EDEX - Purging directory:
"/data_store".
INFO 2014-03-20 10:05:00,155 [Purge-Archive] ArchiveConfigManager: EDEX - Purging directory:
"/archive".
INFO 2014-03-20 10:05:34,515 [Purge-Archive] ArchiveConfigManager: EDEX - Purging directory:
"/data_store".
INFO 2014-03-20 14:05:00,237 [Purge-Archive] ArchiveConfigManager: EDEX - Purging directory:
"/archive".
INFO 2014-03-20 14:05:25,059 [Purge-Archive] ArchiveConfigManager: EDEX - Purging directory:
"/data_store".
```

Purging of a specific data type is logged in the purge log.

**grep -i satellite edex-ingest-purge-20140320.log | grep archive| tail -2**

```
[rschup@dx3-ntca logs]$ grep -i satellite edex-ingest-purge-
20140320.log | grep archive| tail -2
INFO 2014-03-20 16:05:13,362 [Purge-Archive] ArchiveConfigManager: EDEX - Start purge of
category Processed - Satellite, directory "/archive/viirs".
INFO 2014-03-20 16:05:13,413 [Purge-Archive] ArchiveConfigManager: EDEX - End purge of category
Processed - Satellite, directory "/archive/viirs", deleted 9 files and directories.
[rschup@dx3-ntca logs]$
```

### 11.5 Verifying RFC and NC Raw Data Storage Purging

Purging of data from Raw Data Storage is performed using the *scour* process which is part of LDM. The Raw Data Purge is controlled by the cron file *a2cp1cron*, which is part of the *a2cp1apps* high-availability package.

The *ldm scour* cron job is defined in the *a2cp1cron* file, which is staged in */etc/ha.d/cron.d* on CP1 and CP2 and can be found in */etc/cron.d* on the server running *a2cp1apps*. The cron job is executed as the *ldm* user. The directories and retention times for Raw Data Storage are controlled by *scour.conf*, which is located in the *etc* subdirectory of the *ldm* user home directory *cp1f*.

Each row in *scour.conf* contains either two or three entries. The first entry is the directory to manage; the second entry is the retention time of the directory contents in days. When present, the third entry specifies a file name pattern that is used to determine which files to delete; if no pattern is specified, all visible files are deleted. Files are deleted from the specified directory and all subdirectories.

**Note:** *scour* may retain files that are older than the configured retention times. This will occur when the directory containing the files has not been modified (by writing a new file to the directory or its subdirectories) since the last execution of *scour*.

Verify the LDM cron entries in */etc/cron.d/a2cp1cron*.

```
[rschup@cpsbn1-ntca ~]$ grep ldm /etc/cron.d/a2cp1cron
0 0 * * * ldm ~/bin/ldmadmin newlog
0 */3 * * * ldm ~/bin/ldmadmin scour >& ~/logs/scour.log && find
/data_store -depth -type d -empty ! -name fsi -exec rmdir {} \;
```

Check the time and date of the *~ldm/logs/scour* log.

```
[rschup@cpsbn1-ntca ~]$ ll ~ldm/logs/scour.log
-rw-r--r-- 1 ldm fxalpha 0 Jul 17 12:00 scour.log
```

Check the `/var/log/cron` log for current scour entries.

```
[rschup@cpsbn1-ntca ~]$ grep scour /var/log/cron | tail -5
Jul 17 00:00:01 cpsbn1-ntca crond[30317]: (ldm) CMD (~bin/ldmadmin scour >& ~/logs/scour.log &&
find /data_store -depth -type d -empty ! -name fsi -exec rmdir {} \;)
Jul 17 03:00:01 cpsbn1-ntca crond[18665]: (ldm) CMD (~bin/ldmadmin scour >& ~/logs/scour.log &&
find /data_store -depth -type d -empty ! -name fsi -exec rmdir {} \;)
Jul 17 06:00:01 cpsbn1-ntca crond[3929]: (ldm) CMD (~bin/ldmadmin scour >& ~/logs/scour.log &&
find /data_store -depth -type d -empty ! -name fsi -exec rmdir {} \;)
Jul 17 09:00:01 cpsbn1-ntca crond[1588]: (ldm) CMD (~bin/ldmadmin scour >& ~/logs/scour.log &&
find /data_store -depth -type d -empty ! -name fsi -exec rmdir {} \;)
Jul 17 12:00:01 cpsbn1-ntca crond[20291]: (ldm) CMD (~bin/ldmadmin scour >& ~/logs/scour.log &&
find /data_store -depth -type d -empty ! -name fsi -exec rmdir {} \;)
```

Examine the `~ldm/etc/scour.conf` file to determine data retention times.

```
[rschup@cpsbn1-ntca ~]$ cat ~ldm/etc/scour.conf
# Configuration file for "scour" utility, to delete all files older than a
# specified number of days from specified directories and all their
# subdirectories. Scour should be invoked periodically by cron(8).
#
# Each line consists of a directory, a retention time (in days), and
# (optionally) a shell filename pattern for files to be deleted. If no
# filename pattern is specified, "*" representing all files not beginning
# with "." is assumed.
#
# A hash in column one indicates a comment line.

# Directory                Days-old                Optional-filename-pattern
#~ldm/data/dir1           2
#~ldm/data/dir2           2                        *.foo
~ldm/logs                 2                        *.stats
/data_store               1
```

Check the number of files in `/data_store` older than the configured retention time.

```
[rschup@cpsbn1-ntca ~]$ cd /data_store

[rschup@cpsbn1-ntca data_store]$ find . -mtime +1 -type f | wc -l
find: ./lost+found: Permission denied
0
```

## 11.6 Processed Data Storage Purging

Data purging is performed based on purging strategies defined for each data decoder in EDEX. A default, time-based purge strategy is provided for decoders that do not provide a purging strategy.

Time-based purging is based on the reference time of the data. Determination of the reference time is decoder based. In the default purge strategy, all data more than 24 hours old at the time of the purge is deleted.

Purging rules are defined in XML files in the Localization Store on DX3/4. The purge rule files are located in the /awips2/edex/data/utility/common\_static file tree and follow the base/site localization pattern. The base purge rule files are located in base/purge under common\_static; the site purge rule files are located in site/XXX/purge under common\_static, where XXX is the site identifier, e.g., OAX.

The order of precedence for the purge rules is site – base – default; that is, site rules override base rules, which override default rules. When modifying a purge rule, the correct process is to use the Localization Perspective and copy the base file to the site purge rules folder and modify that copy.

Note that the purge rules folder is shared between DX3 and DX4 so the modification is performed on either DX3 or DX4 – not both.

If a plug-in's xml is missing from base/site, then the defaultPurgeRules.xml file is used.

```
[root@dx3-ntca purge]# pwd
/awips2/edex/data/utility/common_static/base/purge

[root@dx3-ntca purge]# ls default*
defaultPurgeRules.xml  defaultPurgeRules.xml.md5

[root@dx3-ntca purge]# cat defaultPurgeRules.xml
<?xml version="1.0" encoding="UTF-8" standalone="yes"?>
<purgeRuleSet>
  <defaultRule>
    <period>01-00:00:00</period>
  </defaultRule>
</purgeRuleSet>
```

Purge rules are accessible from the CAVE localization perspective as shown below.

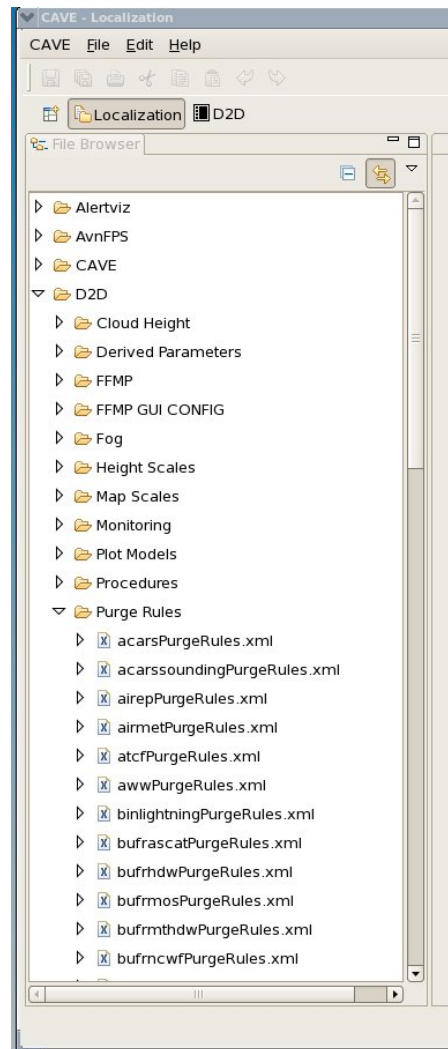

EDEX launches purge once an hour (at 30 minutes after the hour) via quartz. Each time it launches it rereads the xml files, so no EDEX restart is necessary for purge changes.

To see a list of the data plug-ins that have purge rules, perform the following:

Enter: **ssh dx3**

Enter: **cd /awips2/edex/data/utility**

Enter: **find . | grep -i purge**

```

na2-ntca{rschup}106: ssh dx3

dx3-ntca{rschup}102: cd /awips2/edex/data/utility

dx3-ntca{rschup}103: find . | grep -i purge | sort
./common_static/base/purge
./common_static/base/purge/acarsPurgeRules.xml
./common_static/base/purge/acarsPurgeRules.xml.md5
./common_static/base/purge/acarssoundingPurgeRules.xml
./common_static/base/purge/acarssoundingPurgeRules.xml.md5
./common_static/base/purge/airepPurgeRules.xml
./common_static/base/purge/airepPurgeRules.xml.md5
./common_static/base/purge/airmetPurgeRules.xml
./common_static/base/purge/airmetPurgeRules.xml.md5
./common_static/base/purge/atcfPurgeRules.xml
./common_static/base/purge/atcfPurgeRules.xml.md5
./common_static/base/purge/awwPurgeRules.xml
./common_static/base/purge/awwPurgeRules.xml.md5
...

```

To see a list of default purge rules, perform the following (output has been truncated):

```

[root@dx3-ntca purge]# pwd
/awips2/edex/data/utility/common_static/base/purge

[root@dx3-ntca purge]# grep -A3 -B1 '<default' * | less
acarsPurgeRules.xml-<purgeRuleSet>
acarsPurgeRules.xml:      <defaultRule>
acarsPurgeRules.xml-      <versionsToKeep>24</versionsToKeep>
acarsPurgeRules.xml-      <delta>=00-01:00:00</delta>
acarsPurgeRules.xml-      <round>00-01:00:00</round>
--
acarssoundingPurgeRules.xml-<purgeRuleSet>
acarssoundingPurgeRules.xml:      <defaultRule>
acarssoundingPurgeRules.xml-      <versionsToKeep>24</versionsToKeep>
acarssoundingPurgeRules.xml-      <delta>=00-01:00:00</delta>
acarssoundingPurgeRules.xml-      <round>00-01:00:00</round>
--
aggregatePurgeRules.xml-<purgeRuleSet>
aggregatePurgeRules.xml:      <defaultRule>
aggregatePurgeRules.xml-      <period>30-00:00:00</period>
aggregatePurgeRules.xml-      </defaultRule>
aggregatePurgeRules.xml-</purgeRuleSet>
--
....

```



### 11.7 Verifying Processed Data Storage Purging

The EDEX purge service runs as part of the EDEX Ingest process on DX3 and DX4. Purge events are logged to the Ingest Purge log, `edex-ingest-purge-yyyymmdd.log`, located in `/awips2/edex/logs` on both DX3 and DX4. In normal operation, you should see a “START PURGE” message at 30 minutes after each hour on either DX3 or DX4. Problems with the purge will also be in this log file.

The PyPIES process is responsible for deleting data from the HDF5 directory.

#### Verifying EDEX quartz purge process:

EDEX uses a cluster locking mechanism that prevents both EDEX Ingest processes from performing the purge, although the purge may occur on either EDEX server. As a result, the EDEX Ingest logs on both DX3 and DX4 must be examined to verify purging and/or to identify purging problems.

List the current purge log on dx3 and dx4

```
dx3-ntca{rschup}102: ls -ltr /awips2/edex/logs/edex-ingest-purge*.log | tail -1
-rw-rw-rw- 1 awips fxalpha      627701 Mar 26 12:35 edex-ingest-purge-20120326.log

dx3-ntca{rschup}103: ssh dx4

dx4-ntca{rschup}113: ls -ltr /awips2/edex/logs/edex-ingest-purge*.log | tail -1
-rw-rw-rw- 1 awips fxalpha      399108 Mar 26 12:22 edex-ingest-purge-20120326.log
```

Display “START PURGE” and “END PURGE” events.

Enter: **egrep “(START|END)” edex-ingest-purge-\$(date +%Y%m%d).log**

**Note:** Since the purge can occur on either DX3 or DX4, it is possible that no purge events will be logged on DX3. Check the DX4 logs also. Note that the START/END purge events

```

dx3-ntca{randys}116: egrep "(START|END)" edex-ingest-purge-20120918.log
INFO 2012-09-18 00:30:00,003 [DefaultQuartzScheduler_Worker-1] PurgeLogger: EDEX -
PURGE LOGS::-----START LOG PURGE-----
INFO 2012-09-18 00:34:16,762 [DefaultQuartzScheduler_Worker-1] PurgeLogger: EDEX -
PURGE LOGS::-----END LOG PURGE-----
INFO 2012-09-18 03:30:00,004 [DefaultQuartzScheduler_Worker-2] PurgeLogger: EDEX -
PURGE OUTGOING::-----START OUTGOING PURGE-----
INFO 2012-09-18 03:30:00,004 [DefaultQuartzScheduler_Worker-2] PurgeLogger: EDEX -
PURGE OUTGOING::-----END OUTGOING PURGE-----
INFO 2012-09-18 04:30:00,003 [DefaultQuartzScheduler_Worker-1] PurgeLogger: EDEX -
PURGE OUTGOING::-----START OUTGOING PURGE-----
INFO 2012-09-18 04:30:00,003 [DefaultQuartzScheduler_Worker-1] PurgeLogger: EDEX -
PURGE OUTGOING::-----END OUTGOING PURGE-----

```

```

dx3-ntca{rschup}119: ssh dx4

```

```

dx4-ntca{randys}104: egrep "(START|END)" edex-ingest-purge-20120918.log
INFO 2012-09-18 00:30:00,003 [DefaultQuartzScheduler_Worker-7] PurgeLogger: EDEX -
PURGE OUTGOING::-----START OUTGOING PURGE-----
INFO 2012-09-18 00:30:00,003 [DefaultQuartzScheduler_Worker-2] PurgeLogger: EDEX -
PURGE LOGS::-----START LOG PURGE-----
INFO 2012-09-18 00:30:00,004 [DefaultQuartzScheduler_Worker-7] PurgeLogger: EDEX -
PURGE OUTGOING::-----END OUTGOING PURGE-----
INFO 2012-09-18 00:35:29,554 [DefaultQuartzScheduler_Worker-2] PurgeLogger: EDEX -
PURGE LOGS::-----END LOG PURGE-----
INFO 2012-09-18 01:30:00,003 [DefaultQuartzScheduler_Worker-1] PurgeLogger: EDEX -
PURGE OUTGOING::-----START OUTGOING PURGE-----
INFO 2012-09-18 01:30:00,004 [DefaultQuartzScheduler_Worker-1] PurgeLogger: EDEX -
PURGE OUTGOING::-----END OUTGOING PURGE-----
INFO 2012-09-18 02:30:00,006 [DefaultQuartzScheduler_Worker-5] PurgeLogger: EDEX -
PURGE OUTGOING::-----START OUTGOING PURGE-----
INFO 2012-09-18 02:30:00,006 [DefaultQuartzScheduler_Worker-5] PurgeLogger: EDEX -
PURGE OUTGOING::-----END OUTGOING PURGE-----

```

**Verifying PyPies purge:**

The PyPies process runs as part of the dx2f apps package.

List current pypies log.

```
ssh dx2f
cd /awips2/pypies/logs
ls
grep -i delete pypies.log | tail -5
```

```
lx1-ntca{rschup}105: ssh dx2f

dx2-ntca{rschup}101: cd /awips2/pypies/logs

dx2-ntca{rschup}102: ls
pypiesHourlyStats.log pypies.log pypiesMinuteStats.log
pypiesHourlyStats.log.2012-11-13 pypies.log.2013-02-14 pypiesMinuteStats.log.2013-02-14
pypiesHourlyStats.log.2013-01-02 pypies.log.2013-02-21 pypiesMinuteStats.log.2013-02-21
pypiesHourlyStats.log.2013-02-14 pypies.log.2013-02-22 pypiesMinuteStats.log.2013-02-22
pypiesHourlyStats.log.2013-02-21 pypies.log.2013-04-01 pypiesMinuteStats.log.2013-04-01
pypiesHourlyStats.log.2013-02-22 pypies.log.2013-04-17 pypiesMinuteStats.log.2013-04-17
pypiesHourlyStats.log.2013-04-01 pypies.log.2013-06-20 pypiesMinuteStats.log.2013-06-20
pypiesHourlyStats.log.2013-07-16 pypies.log.2013-07-16 pypiesMinuteStats.log.2013-07-16

dx2-ntca{rschup}103: grep -i delete pypies.log | tail -5
WARNING 2013-07-17 13:22:01,038 Unable to find uri [FogW/SFC/2013_07_17_01--2013_07_17_01] in
file [/awips2/edex/data/hdf5/gfe/EAX/SAT/EAX_GRID__SAT_20130717_FogW_SFC.h5] to delete: Traceback
(most recent call last):
File "/awips2/python/lib/python2.7/site-packages/pypies/impl/H5pyDataStore.py", line 351, in
delete
INFO 2013-07-17 14:05:01,322 Processed DeleteFilesRequest on
/awips2/edex/data/hdf5/satellite/East CONUS/Imager Visible/satellite-2013-07-16-18.h5. Timing
entries in seconds: total 0.591, deserialize 0.000, getLock 0.000, releaseLock 0.000, serialize
0.000
INFO 2013-07-17 14:11:00,784 Processed DeleteFilesRequest on
/awips2/edex/data/hdf5/viirs/Alaska/Imagery/11.45/BT/viirs-2013-07-16-13.h5. Timing entries in
seconds: total 0.428, deserialize 0.000, getLock 0.000, releaseLock 0.000, serialize 0.000
INFO 2013-07-17 14:11:01,150 Processed DeleteFilesRequest on
/awips2/edex/data/hdf5/viirs/Alaska/Imagery/3.74/BT/viirs-2013-07-16-13.h5. Timing entries in
seconds: total 0.365, deserialize 0.000, getLock 0.005, releaseLock 0.000, serialize 0.000

dx2-ntca{rschup}102: exit
```

**Verifying data purge:**

To verify the data purge, you need to look at the size of two directory structures on dx1f: the hdf5 data structure in /awips2/edex/data/hdf5; and the PostgreSQL table spaces in /awips2/data.

```
[root@dx1-ntca ~]# du /awips2/data -sh
15G      /awips2/data

[root@dx1-ntca ~]# ssh dx2

[root@dx2-ntca ~]# du /awips2/edex/data/hdf5 -sh
54G      /awips2/edex/data/hdf5
```

These commands can be set up in a cron job to track the space used in these two directory trees and write the results to a log file. This file can be examined periodically and should show generally stable disk usage over time. A simple script to perform this function:

```
#!/bin/bash
SPACE_DB=$(du /awips2/data -sh)
SPACE_HDF=$(du /awips2/edex/data/hdf5 -sh)
TIME_NOW=$(date "+%D %T")
echo "${TIME_NOW} DB: ${SPACE_DB} HDF5: ${SPACE_HDF}" >>
/var/tmp/space_usage.log
```

This script can be run approximately every 10 minutes to provide a good picture of disk space usage for Processed Data Storage. Note that it must be run by the *awips* user on the server running the a2dx1apps high-availability package.

**11.8 Locating a Script**

In order to locate a script:

Log into DX3/DX4

**Type:**        `cd /awips2`

**Type:**        `find . | grep -i <filename>`

An example follows:

**Type:**        `find . | grep -i purge_files`

```
./edex/data/share/hydroapps/whfs/bin/purge_files
./edex/data/share/hydroapps/whfs/local/data/log/misc/purge_files
.log
```

Table 11.5-1 illustrates the various CRONS and their respective locations.

**Table 11.5-1. Cron Locations**

CRON Name	Description	Location
logfilepurger.cron	Runs the purge_files script	/awips2/edex/data/share/hydroapps/whfs/bin/purge_files
ihfsdbpurge.cron	Runs the run_db_purge script to purge the IHFS database	/awips2/edex/data/share/hydroapps/whfs/bin/run_db_purge
floodarchiver.cron	Runs the run_floodseq script	/awips2/edex/data/share/hydroapps/whfs/bin/run_floodseq
mpehpefilepurge.cron	Runs the purge_mpe_files and purge_hpe_files scripts	/awips2/edex/data/share/hydroapps/precip_proc/bin/purge_mpe_files & /awips2/edex/data/share/hydroapps/precip_proc/bin/purge_hpe_files
mpefieldgen.cron	Starts the MPE fieldGen process. This is the runHourlyMpe method in the class.com.raytheon.uf.edex.ohd.pproc.MpeFieldGenSrv	/awips2/edex/data/share/hydroapps/precip_proc/bin/run_mpe_fieldgen
pointdataretrieval.cron	Runs the run_pdc_pp script	/awips2/edex/data/share/hydroapps/whfs/bin/run_pdc_pp
alarmwhfs.cron	Runs the run_alarm_whfs script	/awips2/edex/data/share/hydroapps/whfs/bin/run_alarm_whfs

## 11.9 Hydro Cron Control Application Tokens

Tokens in the Apps\_Defaults configuration allow for execution control of Hydro Cron tasks. Site-specific configuration files allow sites to override the base-deployed configuration with their own configuration.

### 11.6.1 Configuration

Two files (not including the site override files) control the Hydro Cron applications: a configuration file for the quartz cron timers; and a configuration file to set the application ON/OFF tokens.

**Token Configuration:** The Hydro Cron tokens are defined in the base Apps\_Defaults file, which is managed by EDEX Localization. This file is accessible through the localization perspective of CAVE. It is not recommended that this file be edited because base updates will write over this file. See section 11.6.2, **Site-Specific Configurations**, for site customization. Please note that they default to ON.

/awips2/edex/data/utility/common\_static/base/hydro/Apps\_defaults

The delivered Hydro Cron tokens in the Apps\_Defaults file are:

```

#===== Apps/Script Execution Tokens =====
WhfsSrv : ON
WhfsSrv.purge_files : ON
WhfsSrv.run_db_purge : ON
WhfsSrv.run_floodseq : ON
PprocSrv : ON
PprocSrv.purge_mpe_files : ON
PprocSrv.purge_hpe_file : ON
MpeFieldGenSrv.run_mpe_fieldgen : ON
WhfsSrv.run_pdc_pp : ON
WhfsSrv.run_alarm_whfs : ON
WhfsSrv.run_alarm_whfs.run_roc_checker : ON
WhfsSrv.run_alarm_whfs.run_report_alarm : ON
WhfsSrv.run_alarm_whfs.run_report_alarm.textdb : ON
ArealQpeGenSrv : ON
DqcPreProcSrv : ON
DqcPreProcSrv.run_dqc_preprocessor : ON
MpeRUCFreezingLevel : ON
MpeLightningSrv : ON
#=====

```

**Timer Configuration:** The cron timer properties are found in the base `com.raytheon.uf.ohd.properties` file. It is not recommended that this file be edited because base updates will write over this file. In addition, any changes made to this file will not take effect until EDEX is restarted. See section 11.6.2, **Site-Specific Configurations**, for site customization.

```
/awips2/edex/conf/resources/com.raytheon.uf.edex.ohd.properties
```

**Cron Timer Properties:** The cron timing properties look like this:

```

logfilepurger.cron=0+1+1,5,9,13,17,21+***+?
ihfsdbpurge.cron=0+45+7+***+?
floodarchiver.cron=0+30+6+***+?
mpehpefilepurge.cron=0+1+12+***+?
mpefieldgen.cron=0+25+***+?
pointdataretrieval.cron=0+2,17,32,47+***+?
alarmwhfs.cron=0+7,17,27,37,47,57+***+?
arealqpegen.cron=0+10,25,40,55+***+?
dqcpreprocessor.cron=0+20+0,6,12,18+***+?
mpelightningsrv.cron=0+0/30+***+?
freezingLevel.cron=0+5+2,8,14,20+***+?

```

## 11.6.2 Site-Specific Configurations

**Site Token Configuration:** The site-specific tokens can be set in an `Apps_Defaults` file in the `site/***` subdirectory (where `***` is the site; for example, `OAX`). If a token is not defined in the site file, but is defined in the base file, then the base token will be used. This means that only those tokens that a site needs to change from the base token values

need to be in the site file. This file will not be overwritten by base updates. This file should be created and edited through the CAVE Localization perspective.

```
/awips2/edex/data/utility/common_static/site/OAX/hydro/Apps_defaults
```

**NOTE:** The token structure of the form A.b, such as WhfsSrv.purge\_files, works when set within the Apps\_defaults files. However, in the korn and bash shells, command line overrides, which allow temporary token value assignment via something like “export WhfsSrv=OFF,” will not work for any of the above tokens where “.” occurs, as neither of those shells allows a simple variable assignment of the form a.b=x. The get\_apps\_defaults system looks for tokens defined as env’t vars as overrides. However, for purposes of these tokens, to control cron executions, the need for a command line override, e.g., within a script, is unlikely.

**Site Timer Configuration:** Site-specific cron timing properties can be defined in the site subdirectory, site/\*\*\*. These properties are not managed by localization. These properties will override the base properties defined above. If a property is not defined in the site file, but is defined in the base file, then the base property will be used. This means that only those properties that a site needs to change from the base properties need to be in the site file. These properties will be preserved when updates are deployed. For changes to this file to take effect, EDEX must be restarted. The following example is for an EDEX running with OAX site settings.

```
/awips2/edex/conf/resources/site/OAX/com.raytheon.uf.edex.ohd.properties
```

If the site directory path does not exist, you will need to create it. This is how it works:

Hydro Cron application control works by using a property, APP\_CONTEXT, to contain the application context for the currently running Java code or shell script.

The property is managed by utility methods in AppsDefaults.java for Java code and the utility script check\_app\_context for scripts.

In Java, it is a system property; in scripts, it is an environment variable. The environment variable is passed to any scripts that the java code starts.

Java code started by the crons set and check APP\_CONTEXT by calling AppDefaults.setAppContext (Object). If the method returns true, the code continues; otherwise it exits. The AppDefaults methods log will reveal whether the code was executed or not.

MainMethod.java sets up the ProcessBuilder environment for scripts started by java code. MainMethod uses AppsDefaults.setAppContext(processBuilder) to set the APP\_CONTEXT environment variable for the script. Scripts source the utility script, check\_app\_context, to set and check the environment variable APP\_CONTEXT.

The utility script, `check_app_context`, will default to true if no `APP_CONTEXT` variable or token is found, so scripts that call this method can still be used from the command line.

A step-by-step example follows. For this example, the Java code, `WhfsSrv`, executes the script `run_alarms_whfs`, which executes the script `run_roc_checker`.

The Site App tokens used in this example are:

<code>WhfsSrv</code>	ON
<code>WhfsSrv.run_alarms_whfs</code>	ON
<code>WhfsSrv.run_alarms_whfs.run_roc_checker</code>	OFF

1. When `WhfsSrv` is run, it calls `AppsDefaults.setAppContext(Object)`.
2. There will not be a value set for the `APP_CONTEXT` at this time. It will set the `APP_CONTEXT` to “`WhfsSrv`”. Then this value is used to retrieve the App token. In the example App tokens above, “`WhfsSrv`” is set to ON. `AppsDefaults.setAppContext(Object)` will return true.
3. `WhfsSrv` will continue execution and run the script `run_alarms_whfs`.
4. `run_alarms_whfs` will source `check_app_context`, which will add `run_alarms_whfs` to the `APP_CONTEXT` (which will then be “`WhfsSrv.run_alarms_whfs`”) and use that value to check for the App token. In the example App tokens above, “`WhfsSrv.run_alarms_whfs`” is set to ON. `check_app_context` will log this, and `run_alarms_whfs` will continue execution and run the script `run_roc_checker`.

`run_roc_checker` will source `check_app_context`, which will add `run_roc_checker` to the `APP_CONTEXT` (which will then be “`WhfsSrv.run_alarms_whfs.run_roc_checker`”) and use that value to check for the App token. In the preceding example App tokens, “`WhfsSrv.run_alarms_whfs.run_roc_checker`” is set to OFF. `check_app_context` will log this and exit the script `run_roc_checker`. `run_alarms_whfs` will then continue from the point after it ran `run_roc_checker`.

### 11.6.3 Logging

Hydro Cron logging is in the EDEX ingest log:

```
/awips2/edex/logs/edex-ingest-YYYYMMDD.log
```

where YYYY is the year, MM the month, and DD the day of the month.

Note that, even when scripts are turned off, these messages will still be logged.

- For Java output, look for:  
App Execution Token for App Context <Java context> is  
<true|false>



- For script output, look for:  
App Execution Token for script <script name> with App  
Context <script context> is <ON|OFF>

Scripts that are not executed also log this message

Script <script name> will exit and not run.

# **Chapter 12**

## **Database Management**

## Chapter 12. Database Management

### Table of Contents

	<i>Page</i>
12.1 AWIPS II Database Management.....	1
12.1.1 Rehosted Databases .....	1
12.2 Text DB Overview .....	2
12.3 Other PostgreSQL Databases .....	5
12.4 PostgreSQL Database Environment Variables.....	5
12.5 PostgreSQL Database Archiving.....	6
12.6 PostgreSQL Database Sparring.....	6
12.7 PostgreSQL Logs.....	6
12.8 Checking System Processes.....	7
12.9 Monitoring PostgreSQL-Dependent Applications .....	7
12.10 PostgreSQL Cron.....	8
12.11 Stopping/Starting Database Engine Dependent Applications .....	9
12.12 PostgreSQL Vacuum Operations.....	9
12.13 Verifying AWIPS II Data Purging.....	10
12.13.1 Verify Purging of Data from the AWIPS II Raw Data Store .....	10
12.13.2 Verify Execution of the EDEX Purge Service on DX3 and DX4.....	11
12.13.3 Verify Purging of Data from the AWIPS II HDF5 Processed Data Store .....	16
12.14 Triggers.....	17
12.14.1 Environmental Variables .....	18
12.14.1.1 Logging.....	19
12.14.1.2 Migrating AWIPS I to AWIPS II.....	19
12.14.1.3 Viewing Current Triggers in AWIPS II.....	19
12.14.1.4 Updating Triggers in AWIPS II.....	19
12.15 Text Triggers .....	20
12.15.1 Configuring Text Triggers .....	20
12.15.1.1 ADAPT Text Triggers .....	21
12.15.1.2 LDAD Text Triggers .....	22
12.15.1.3 Installing a New Idad Trigger .....	24
12.15.1.4 Facsimile (fax) Text Triggers .....	26
12.15.1.5 Local Site Text Triggers .....	26

### List of Tables

Table 12.1.1-1. Databases Reused from AWIPS I.....	1
Table 12.4-1. PostgreSQL Environmental Variables.....	5
Table 12.9-1. WFO/RFC PostgreSQL-Dependent Databases .....	7
Table 12.9-2. Linux Commands for Monitoring Processes that Impact the PostgreSQL Database7	7

Table 12.15.1-1. Text Trigger Template Files ..... 21  
Table 12.15.1.2-1. LDAD Trigger Template File Directives..... 23

PostgreSQL is the official database for AWIPS. For AWIPS II, the PostgreSQL database is hosted on the database cluster (DX 1/2). AWIPS II utilizes several of the existing AWIPS databases, although they are re-hosted into a new PostgreSQL instance. AWIPS II also adds additional databases to support the new ingest and display paradigms used by AWIPS II.

### 12.1 AWIPS II Database Management

AWIPS II uses the Dam Catalog (DAMCAT), Text (FXATEXT), hydrology (HYDRO), and climatology (HMDB) databases from AWIPS I. FXATEXT has some changes, the most visible change being that it is not using the watchwarn table. (Triggers have been moved into the subscriptions table in the fxatext database.)

AWIPS II has introduced two databases to the mix: *maps* and *metadata*. *maps* contains definitions of shapes for the various maps used in CAVE and is generally static. *metadata* contains all other AWIPS II-specific data used by CAVE and EDEX. This data is generally dynamic, but some tables are static. The *awips* schema includes tables containing product metadata, some of which are static. It also includes the VTEC active table and the practice active table, which are used by WarnGen and GFE. Both of these schemas and their tables are created when the database is installed.

AWIPS II handles database (and data store) purges via a quartz-triggered component of EDEX; as a result, there are no cron jobs related to AWIPS II data purging.

In AWIPS II, PostgreSQL is started and stopped using a script called **edex\_postgres**, which is located in `/etc/init.d` on the database server.

There are two `dx1f` crons for postgres, **backup\_pgdb\_a2 -a** and **backup\_pgdb\_a2 -d metadata**. They are used for backing up the database (metadata gets backed up more often to have a more recent snapshot of ingested data).

#### 12.1.1 Rehomed Databases

AWIPS II reuses several databases from AWIPS I; they are listed in Table 12.1.1-1.

**Table 12.1.1-1. Databases Reused from AWIPS I**

Table	Comment
hd_ob92xxx	hydrology database, replace <b>xxx</b> with site ID
dc_ob7xxx	Dam Catalog, replace <b>xxx</b> with site ID
hmdb	historical meteorological database
ob7_histdata	(RFC only) Historical river data

All databases that AWIPS II reuses are imported into the AWIPS II database at initial system installation.

AWIPS II uses a modified version of the Text database (fxatext). See section 12.2 for additional details on the fxatext database.

## 12.2 Text DB Overview

Decoded text products are stored in a PostgreSQL database on the Direct Attached Storage (DAS). The partition where the database resides is mounted to dx1f. The database works on a circular buffer basis storing the newest version of each product over the oldest. The number of versions of each product or category of products is specified in the versionstokeep field of the textproductinfo table.

Note that setting versionsToKeep to 0 will disable purging of the product, while setting versionsToKeep to -1 is not supported.

The **fxatext** database consists of seven tables:

1. afoslookup
2. afos\_to\_awips
3. autofaxrecord
4. statematch
5. stdtextproducts
6. practicestdtextproducts
7. textproductinfo
8. watchwarn
9. subscriptions

### afoslookup

This table contains a mapping of AFOS CCC codes to WMO sites. It has two columns: **ccc** and **origin**. An example follows.

<u>ccc</u>	<u>origin</u>
WBC	K7VM
BHM	KAAF
PHL	KABE
LBB	KABI
ABQ	KABQ
FSD	KABR
ABQ	KABX
FTW	KACT
PHL	KACY
ARB	KADG

**afos\_to\_awips**

This table stores the WMO identifier and WMO ttaaii code for each AFOS PIL (afosid). It has three columns: **afosid**, **wmocccc**, and **wmottaaii**. An example follows.

<u>afosid</u>	<u>wmocccc</u>	<u>wmottaaii</u>
ABQABVABQ	KABQ	UFUS45
ABQADAABQ	KABQ	NOUS75
ABQADMABQ	KABQ	NOUS75
ABQADMZAB	KABQ	NOUS75
ABQADRABQ	KABQ	NOUS45
ABQADRABQ	KABQ	WOUS45
ABQADRNM	KABQ	WOUS45
ABQAFDABQ	KABQ	FXUS65
ABQAFMABQ	KABQ	FOUS55
ABQAFPABQ	KABQ	FLUS45

**statematch**

This table contains a listing of all **xxx** and **ccc** ID combinations for a state. It has three columns: **state**, **xxx**, and **ccc**. An example follows.

<u>state</u>	<u>ccc</u>	<u>xxx</u>
MO	UNO	STL
MO	VIH	STL
MS	137	JAN
MS	138	JAN
MS	139	JAN
MS	140	JAN
MS	BIX	JAN
MS	BKS	JAN
MS	CBM	JAN
MS	GLH	JAN
MS	GPT	JAN
MS	GTR	JAN
MS	GWO	JAN
MS	HBG	JAN

**stdtextproducts**

This table stores standard text products such as TAFs and METAR observations. It includes information on the version and creation time for standard products stored in the database. The product is also displayed. The table has 10 columns: **cccid**, **datacrc**, **hdrtime**, **nnnid**, **site**, **wmoid**, **xxxid**, **bbbid**, **createtime**, and **product**. Two examples follow.

```

Cccid      FTW
Datacrc    3901128814
Hdrtime    050800
Nnnid      MTR
Site       KPRX
Wmoid      SAUS70
Xxxid      PRX
Bbbid      RRN
Createtime 1280994984898
Product
SAUS70 KPRX 050800 RRN
KPRX 050755Z 22005KT 10SM CLR 27/23 A2989 RMK 01

```

```

Cccid      CHI
Datacrc    1130462633
Hdrtime    051157
Nnnid      RR2
Site       KDVN
Wmoid      SRUS53
Xxxid      DVN
Bbbid
Createtime 1281009462718
Product
SRUS53 KDVN 051157
RR2DVN
IVROCS
.A MTCI2 0805 C DH0745/TX 84/TN 64/TA 70/PP 0.02/AD 01/
.A DNNI4 0805 C DH07/TX 87/TN 70/TA 70/PP T/AD 09/

```

### **practicestdtextproducts**

This table stores text products such as TAFs and METAR observations issued when CAVE/Text WS is in practice mode. It has the same structure as the stdtextproducts table.

### **textproductinfo**

This table stores version information for each product in the database. It has four columns: **cccid**, **nnnid**, **xxxid**, and **versionstokeep**. An example follows.

<u>Cccid</u>	<u>Nnnid</u>	<u>Xxxid</u>	<u>versionstokeep</u>
WSR	UAM	BBX	2
LBB	MTR	ELP	6
MSP	RR2	MSR	2
NYC	MTR	JFK	6
PHL	MTR	ABE	6
PWM	MTR	MWN	6
BIS	RRZ	LDA	2
BOI	MTR	SNT	26
PWM	MTR	CON	6
PWM	MTR	PWM	6
NCF	WTS	NCF	2
ARB	MTR	P58	6



MKE	MTR	MKE	6
BOS	MTR	PVD	6

### watchwarn

The watchwarn table is no longer in use and should be empty. It has been replaced by the subscription table.

## 12.3 Other PostgreSQL Databases

The PostgreSQL database engine is also utilized by hydrology applications and interactive forecast applications. Descriptions of their PostgreSQL use may be found in the Government's application-specific documentation.

## 12.4 PostgreSQL Database Environment Variables

The PostgreSQL database engine runs on the Linux data server where the dx1f floating heartbeat address resides (either DX1 or DX2). The following chart lists the environment variables set for DX1 and DX2. These variables (DXs) need to be established (using the **setenv** or **export** commands) before executing the PostgreSQL commands listed on the following pages. Table 12.4-1 lists the environment variables.

**NOTE:** AWIPS II uses a different paradigm for setting the runtime environment required by AWIPS II applications. In this paradigm, the environment is set in the application startup script. As a result, these environment variables are not required for running AWIPS II applications. They are retained here for compatibility with AWIPS I scripts.

**Table 12.4-1. PostgreSQL Environmental Variables**

Environment Variables	Description	DX1 and DX2
PGDATA	Directory (or partition) for cluster data and default data base data	/data/db/pgdata
PGDATA_IHFS	Partition for IHFS and DAMCREST	/data/db/ihfs
PGDATA_FXATEXT	Partition for FXATEXT	/data/db/fxatext
PGDATA_HMDB	Partition for HMDB	/data/db/hmdb
PGDATA_IFPS	Partition for IFPS and WWA	/data/db/ifps
PGHOST	PostgreSQL host device	dx1f
PG_INSTALL	Installation directory	/usr
PGDATA_TOP	Top of the data directory tree	/data/db
PGPORT	Port definition	5432
PGUSER	Non-administrative user	Postgres
PATH	Path to PostgreSQL	Includes /usr/include/pgsql
TERM	Terminal setting	vt100
PGDATA_LOCAL	Partition for local RFC databases	/data/db/dblocalrfc
<b>Note:</b> For the PXs and LXs, \$PGDATA is defined as /var/lib/pgsql/data.		

## 12.5 PostgreSQL Database Archiving

The entire PostgreSQL database is backed up daily at about 2205Z by running a cron that executes a backup of each individual database. The log files created from this backup are stored using the following naming convention:

backup\_<db>\_<date>

Where <db> is the database - in AWIPS it is **pgdb** (PostgreSQL database), and <date> is the month and day in MMDD format.

Example for 27 Oct 2011: **backup\_pgdb\_1027**. This file is located in **/data/logs/fxa** on dx1.

An example of the backup file for **backup\_pgdb\_1027** is as follows:

```
Oct 27 01:10:02 BEGIN pg_dump metadata
Oct 27 01:14:51 END pg_dump metadata EXIT_CODE=0
Oct 27 05:10:01 BEGIN pg_dump metadata
Oct 27 05:14:33 END pg_dump metadata EXIT_CODE=0
Oct 27 09:10:01 BEGIN pg_dump metadata
Oct 27 09:14:48 END pg_dump metadata EXIT_CODE=0
Oct 27 13:10:02 BEGIN pg_dump metadata
Oct 27 13:15:25 END pg_dump metadata EXIT_CODE=0
```

**Note:** For manual backup, the cron entry is

```
05 22 * * * root /awips/ops/bin/backup_pgdb_a2 -
```

The log file is **/data/logs/fxa/backup\_pgdb\_<MMDD>**

**Note:** The database backups are in **/data/fxa/DAILY\_BACKUP/postgres/<Day>dc\_ob70ax, fxatext, globals, hd\_ob830ax, hd\_ob92eax, hb\_ob92ntc, hmdb, ifps\_eax, lsldata, maps, metadata, postgres**

## 12.6 PostgreSQL Database Sparing

If the primary Linux Data Server (DX1) fails, PostgreSQL operations move to the DX2. The database itself is on the Network Appliance (NetApp) FAS2020C DAS, attached to the DX so it is not affected if the DX1 fails.

## 12.7 PostgreSQL Logs

PostgreSQL logs its actions in **/awips2/data/pg\_log**. It also has logs for its database backups (see section 12.5) and vacuum operations (see section 12.12). These logs reside in the **/data/logs/fxa** directory on nas1-<siteID>.

## 12.8 Checking System Processes

To check the system processes on the PostgreSQL Database:

**TYPE:**

`ps -wef | grep postgres`

- You should see output similar to the following:

```
postgres 19792      1      0 Mar21 ?    00:00:15 /usr/bin/postgres -D /data/db/pgdata
postgres 20002 19792      0 Mar21 ?    00:00:18 postgres: writer process
postgres 20003 19792      0 Mar21 ?    00:00:00 postgres: stats collector process
postgres 20308 19792      0 Mar21 ?    00:00:25 postgres: pguser fxatext 165.92.29.195(36485)
idle
postgres 20318 19792      1 Mar21 ?    01:31:21 postgres: pguser fxatext 165.92.29.195(36492)
idle
postgres 23407 19792      0 Mar21 ?    00:00:09 postgres: pguser hd_ob83sto
165.92.29.195(36740) idle
postgres 30667 19792      0 Mar25 ?    00:01:09 postgres: pguser hmdb 165.92.29.133(39860) idle
```

## 12.9 Monitoring PostgreSQL-Dependent Applications

AWIPS II PostgreSQL-dependent databases are listed in Table 12.9-1.

**Table 12.9-1. WFO/RFC PostgreSQL-Dependent Databases**

WFO	RFC
fxatext	fxatext
dc_obx<site>	hd_obx<site>
hd_obx<site>	dc_obx<site>
ifps_<site>	
wwa_<site>	
hmdb	
lsrdata	

**NOTE:** The ifps\_<site>, wwa\_<site> and lsrdata are not used by AWIPS II software.

► **To Check Processes Executing on the Active DX**

The following process must be executing at all times on the active Linux data server:

- `postgres <database>` as root or postgres

To check the processes executing on the active data server, use the **grep** command for the process you want to monitor (see Table 12.9-2).

**Table 12.9-2. Linux Commands for Monitoring Processes that Impact the PostgreSQL Database**

Use	UNIX Command	User
-----	--------------	------

**Table 12.9-2. Linux Commands for Monitoring Processes that Impact the PostgreSQL Database**

Use	UNIX Command	User
Monitor whether PostgreSQL is running	<code>ps -wef   grep postgres</code>	root or postgres

► **To Check Interaction between the PostgreSQL Database and the TextDB Server**

Log in remotely to either server in the EDEX cluster (DX3 or DX4). As user **fxa** or your individual user account, execute any of the following commands for checking the **fxatext** database:

**NOTE:** AFOS commands are case sensitive.

- TYPE:** `textdb -r <AFOS_PIL>`
- Performs a standard AFOS read, for example  
`textdb -r PITAFDPIT`
- TYPE:** `textdb -w <productID> or <AFOS_PIL>`
- Writes the product to the database, for example  
`textdb -w PITAFDPIT`
- TYPE:** `textdb -t <productID> or <AFOS_PIL>`
- Retrieves create time for products, for example  
`textdb -t PITAFDPIT`
- TYPE:** `textdb -A <productID> or <AFOS_PIL>`
- Retrieves all times for a product, for example  
`textdb -A BOSMTRBOS`

### 12.10 PostgreSQL Cron

The PostgreSQL *vacuum/analyze* cron executes frequently to maintain a fairly level steady-state usage of disk space. PostgreSQL's *vacuum* command must be run on a regular basis for several reasons:

- To recover disk space occupied by updated or deleted rows. This disk space must be reclaimed for reuse by new rows to avoid infinite growth of disk space requirements.
- To update data statistics used by the PostgreSQL query planner to run better database queries. This information is gathered via the *analyze* command, which can be run as an option by *vacuum* and is set up to run as part of the cron.
- To protect against the loss of very old data due to transaction ID wraparounds that can occur if more than two billion database transactions occur before the *vacuum* command is run for that database.

### 12.11 Stopping/Starting Database Engine Dependent Applications

If the PostgreSQL database engine must be stopped and restarted manually, the **EDEX processes on DX3 and DX4** must also be stopped and restarted manually in a specific sequence.

As user **root** on both DX3 and DX4, perform the following steps.

1. On DX3, stop the EDEX processes  
**TYPE:           service edex\_camel stop**
2. On DX4, stop the EDEX processes  
**TYPE:           service edex\_camel stop**
3. On DX3, verify these processes have all stopped. As any user  
**TYPE:           service edex\_camel status**
4. On DX4, verify these processes have all stopped. As any user  
**TYPE:           service edex\_camel status**

When the database engine is backed up, you will need to restart all of these processes. First, verify that they are down by rerunning the status command (steps 3 and 4 above), and then restart the processes if they are down.

As user **root** on DX3, restart the **EDEX processes**.

**TYPE:           service edex\_camel start**

Still as user **root**, but on DX4, restart the **EDEX processes**

**TYPE:           service edex\_camel start**

### 12.12 PostgreSQL Vacuum Operations

PostgreSQL **vacuum** operations occur every 4 hours for the **hdob<version><site>** database, twice a day for **hmdb** and **fxatext**, and once a day for the other databases. The log files created from this operation are located in **/data/logs/fxa/**.

Database logging for AWIPS applications continues as previously done. Log files for some AWIPS applications are still found in the **/data/logs/fxa** directory (e.g., **ingProcMon.log**), and the logs for the other AWIPS applications still reside in the **/data/logs/fxa/<YYYYMMDD>** directory (e.g., **/data/logs/fxa/20111017** for 17 October 2011).

### 12.13 Verifying AWIPS II Data Purging

Data purging is the process of deleting outdated data from the data storage systems. In AWIPS II, data purging involves the following: purging data from the AWIPS II Raw Data Store; verifying the execution of the EDEX purge service on DX3 and DX4; and purging data from the AWIPS II HDF5 Processed Data Store.

Validation of purging will be somewhat different for each area, but the general strategy is:

1. Determine the retention strategy used for the purge.
2. Verify that the purge is scheduled.
3. Examine the appropriate process logs to determine if the purge has taken place.
4. Examine the data to verify that the purge has taken place.

The strategy for verifying that data has been purged is somewhat different for a database than for a file system, but, essentially, you compare a count of “all” data against the count of “old” data. The count of old data should be zero or significantly less than the count of all data. Note that counting data by age can be rather time consuming.

The AWIPS II Processed Data Storage purge is managed by the EDEX Ingest processes running on the DX3/4 cluster. Purge events are logged to the `edex-ingest-purge-yyyymmdd.log` file in `/awips2/edex/logs`. This file is located on both DX3 and DX4, although EDEX uses a locking mechanism between DX3 and DX4 to ensure that only one purge executes at any one time. The purge log lists the number of items purged for each purge rule every time a purge is run. Because the log is maintained on both EDEX servers, both servers need to be checked to verify purge execution.

Descriptions of the three areas of AWIPS II data purging identified in this section follow.

#### 12.13.1 Verify Purging of Data from the AWIPS II Raw Data Store

A quartz cron job on the EDEX ingest server manages purging of the AWIPS II Raw Data Store. The Raw Data Store is purged using a time-based retention strategy, which is configured using Archive Retention.

**Note:** Archiver purging of raw data is only for WFOs. The ldm raw data purge continues for NCEP and RFC platforms.

The steps follow.

1. Open a terminal window on your workstation.
2. Log into the EDEX ingest server.

**Enter:**     `ssh awips@dx3`

3. Change directory to the EDEX logs.

**Enter:**     `cd /awips2/edex/config/resources`

- Verify that the Archive purge is enabled and that it has a valid quartz cron entry.

```
Enter:    grep archive.purge
           com.raytheon.uf.edex.archive.cron.properties
           archive.purge.enable=true
           archive.purge.cron=0+5+0/3+*+*+?
```

- Change directory to the EDEX log directory.

```
Enter:    cd /awips2/edex/logs
```

- Verify that the Archive Purge is firing.

```
INFO 2014-01-17 00:07:23,410 [Purge-Archive]
ArchivePurger: EDEX - Processed::Archive Purged 33345 files
in 2m22s.

INFO 2014-01-17 00:07:23,410 [Purge-Archive]
ArchiveConfigManager: EDEX - Purging directory:
"/data_store".

INFO 2014-01-17 00:07:23,421 [Purge-Archive]
ArchiveConfigManager: EDEX - Start purge of directory:
"/data_store/mhs".

INFO 2014-01-17 00:07:23,457 [Purge-Archive]
ArchiveConfigManager: EDEX - End purge of directory:
"/data_store/mhs", deleted 0 files and directories.

INFO 2014-01-17 00:07:23,457 [Purge-Archive]
ArchiveConfigManager: EDEX - Start purge of category Raw -
radar, directory "/data_store/radar".

INFO 2014-01-17 00:07:56,463 [Purge-Archive]
ArchiveConfigManager: EDEX - End purge of category Raw -
radar, directory "/data_store/radar", deleted 15797 files
and directories.
```

- Exit the shell.

### 12.13.2 Verify Execution of the EDEX Purge Service on DX3 and DX4

The EDEX purge service runs as part of the EDEX Ingest process on DX3 and DX4. *Purge* events are logged to the Ingest Purge log, *edex-ingest-purge-yyyymmdd.log*, located in */awips2/edex/logs* on both DX3 and DX4. In normal operation, you should see a “START PURGE” message at 30 minutes after each hour on either DX3 or DX4. Problems with the purge will also be in this log file.

The steps follow.

- Open a terminal window on your workstation.
- Log into DX3 as the *root* user.

```
Enter:    ssh root@dx3
```

3. Switch to the bash shell.

**Enter:** `bash`

4. Change directory to the EDEX log directory.

**Enter:** `cd /awips2/edex/logs`

5. List the current purge log.

**Enter:** `ls edex-ingest-purge-$(date +%Y%m%d).log`

**Note:** Because the purge can occur on either DX3 or DX4, it is possible that there will be no purge log on DX3. In that case you may skip the next step.

```
edex-ingest-purge-20130212.log
```

6. Display “START PURGE” and “END PURGE” events.

**Enter:** `egrep -A2 "(START|END) PURGE" edex-ingest-purge-$(date +%Y%m%d).log`

**Note:** Because the purge can occur on either DX3 or DX4, it is possible that no purge events will be logged on DX3.

7. Terminate the bash shell.

**Enter:** `exit`

8. Log off DX3.

**Enter:** `exit`

9. Log into DX4 as the *root* user.

**Enter:** `ssh root@dx4`

10. Switch to the bash shell.

**Enter:** `bash`

11. Change directory to the EDEX log directory.

**Enter:** `cd /awips2/edex/logs`

12. List the current purge log.

**Enter:** `ls edex-ingest-purge-$(date +%Y%m%d).log`

**Note:** Because the purge can occur on either DX3 or DX4, it is possible that there will be no purge log on DX4. In that case, you may skip the next step.

```
edex-ingest-purge-20141023.log
```

13. Display “START PURGE” and “END PURGE” events.

**Enter:** `egrep -A2 "(START|END) PURGE" edex-ingest-purge-$(date +%Y%m%d).log`



**Note:** Because the purge can occur on either DX3 or DX4, it is possible that no purge events will be logged on DX4.

```
EDEX - PURGE LOGS:-----START LOG PURGE-----
INFO 2014-10-23 00:30:00,000 [DefaultQuartzScheduler-
clusteredpurgeContext_Worker-6] PurgeLogger: EDEX - PURGE
OUTGOING:-----START OUTGOING PURGE-----
INFO 2014-10-23 00:30:00,008 [DefaultQuartzScheduler-
purgeLogsContext_Worker-10] PurgeLogger: EDEX - PURGE
LOGS::Skipped unknown file: edex-ingestDat-
20140910.log.1.lck
INFO 2014-10-23 00:30:00,008 [DefaultQuartzScheduler-
purgeLogsContext_Worker-10] PurgeLogger: EDEX - PURGE
LOGS::Skipped file with invalid fileName:
apsPilTrigger.log
INFO 2014-10-23 00:30:00,008 [DefaultQuartzScheduler-
purgeLogsContext_Worker-10] PurgeLogger: EDEX - PURGE
LOGS::Skipped unknown file: edex-request-20141023.log.lck
INFO 2014-10-23 00:30:00,008 [DefaultQuartzScheduler-
purgeLogsContext_Worker-10] PurgeLogger: EDEX - PURGE
LOGS::Skipped unknown file: edex-request-
20140910.log.1.lck
INFO 2014-10-23 00:30:00,008 [DefaultQuartzScheduler-
purgeLogsContext_Worker-10] PurgeLogger: EDEX - PURGE
LOGS::Skipped unknown file: edex-ingestGrib-
20140801.log.1
INFO 2014-10-23 00:30:00,008 [DefaultQuartzScheduler-
purgeLogsContext_Worker-10] PurgeLogger: EDEX - PURGE
LOGS::Skipped unknown file: edex-ingestGrib-
20141023.log.lck
INFO 2014-10-23 00:30:00,008 [DefaultQuartzScheduler-
purgeLogsContext_Worker-10] PurgeLogger: EDEX - PURGE
LOGS::Skipped unknown file: edex-request-20140910.log.1
INFO 2014-10-23 00:30:00,009 [DefaultQuartzScheduler-
purgeLogsContext_Worker-10] PurgeLogger: EDEX - PURGE
LOGS::Skipped unknown file: edex-ingestDat-
20141023.log.lck
INFO 2014-10-23 00:30:00,009 [DefaultQuartzScheduler-
purgeLogsContext_Worker-10] PurgeLogger: EDEX - PURGE
LOGS::Skipped unknown file: edex-ingest-20140812.log
INFO 2014-10-23 00:30:00,009 [DefaultQuartzScheduler-
purgeLogsContext_Worker-10] PurgeLogger: EDEX - PURGE
LOGS::Skipped unknown file: edex-ingestDat-
20141023.log.lck
INFO 2014-10-23 00:30:00,009 [DefaultQuartzScheduler-
purgeLogsContext_Worker-10] PurgeLogger: EDEX - PURGE
LOGS::Skipped unknown file: edex-ingest-20140812.log.1
INFO 2014-10-23 00:30:00,009 [DefaultQuartzScheduler-
purgeLogsContext_Worker-10] PurgeLogger: EDEX - PURGE
LOGS::Skipped unknown file: edex-ingestDat-20140910.log.1
INFO 2014-10-23 00:30:00,009 [DefaultQuartzScheduler-
purgeLogsContext_Worker-10] PurgeLogger: EDEX - PURGE
LOGS::Skipped unknown file: edex-ingest-
20140812.log.1.lck
INFO 2014-10-23 00:30:00,009 [DefaultQuartzScheduler-
```

```

purgeLogsContext_Worker-10] PurgeLogger: EDEX - PURGE
LOGS::Skipped unknown file: edex-request-20140625.log.1

INFO 2014-10-23 00:30:00,009 [DefaultQuartzScheduler-
purgeLogsContext_Worker-10] PurgeLogger: EDEX - PURGE
LOGS::Skipped unknown file: edex-request-
20140625.log.1.lck

INFO 2014-10-23 00:30:00,009 [DefaultQuartzScheduler-
purgeLogsContext_Worker-10] PurgeLogger: EDEX - PURGE
LOGS::Skipped unknown file: edex-ingestGrib-
20140731.log.lck

INFO 2014-10-23 00:30:00,009 [DefaultQuartzScheduler-
purgeLogsContext_Worker-10] PurgeLogger: EDEX - PURGE
LOGS::Skipped unknown file: edex-request-20140718.log.lck

INFO 2014-10-23 00:30:00,009 [DefaultQuartzScheduler-
purgeLogsContext_Worker-10] PurgeLogger: EDEX - PURGE
LOGS::Skipped unknown file: edex-ingest-20141023.log.lck

INFO 2014-10-23 00:30:00,009 [DefaultQuartzScheduler-
purgeLogsContext_Worker-10] PurgeLogger: EDEX - PURGE
LOGS::Skipped unknown file: edex-ingest-20140731.log.lck

INFO 2014-10-23 00:30:00,009 [DefaultQuartzScheduler-
purgeLogsContext_Worker-10] PurgeLogger: EDEX - PURGE
LOGS::Skipped unknown file: edex-ingestDat-
20140731.log.lck

INFO 2014-10-23 00:30:00,009 [DefaultQuartzScheduler-
purgeLogsContext_Worker-10] PurgeLogger: EDEX - PURGE
LOGS::Removed 1 old files

INFO 2014-10-23 00:30:00,029 [DefaultQuartzScheduler-
clusteredpurgeContext_Worker-6] PurgeLogger: EDEX - PURGE
OUTGOING::Skipped file with unexpected fileName:
447_test.doc

INFO 2014-10-23 00:30:00,029 [DefaultQuartzScheduler-
clusteredpurgeContext_Worker-6] PurgeLogger: EDEX - PURGE
OUTGOING::Removed 0 files

INFO 2014-10-23 00:30:00,029 [DefaultQuartzScheduler-
clusteredpurgeContext_Worker-6] PurgeLogger: EDEX - PURGE
OUTGOING::-----END OUTGOING PURGE-----

```

14. Terminate the bash shell.

**Enter:** `exit`

15. Log off DX4.

**Enter:** `exit`

16. Expected results: If the EDEX Purge service is firing correctly, you should see paired “START PURGE” and “END PURGE” events at about 30 minutes after each hour. **Note:** If this procedure is executed shortly after 30 minutes after the hour, the final “START PURGE” event will not have a paired “END PURGE” event. Compare the results of the *egrep* commands in steps (f) and (m); there should be log entries covering all hours of the current day.

17. Error results: Any missing “START PURGE” messages should be investigated. EDEX uses a database table (*awips.cluster\_task* in the *metadata* database) to manage process locking between DX3 and DX4. As a result, any database-related errors in the purge log should be investigated. An example follows.

```
INFO 2013-02-12 00:49:00,138 [Purge-TAF-Thread] PurgeLogger:
EDEX - TAF::Purging expired data...
```

```
FATAL 2013-02-12 00:49:02,565 [DefaultQuartzScheduler_Worker-
2] PurgeLogger: EDEX - TEXT::Purger running time has exceeded
timeout duration of 20 minutes. Current running time: 21
minutes
```

```
ERROR 2013-02-12 00:49:02,586 [DefaultQuartzScheduler_Worker-
2] PurgeLogger: EDEX - TEXT::Stack trace for Purge Job
Thread:
```

```
Thread ID: 16619 Thread state: RUNNABLE
```

```
java.net.SocketInputStream.socketRead0(Native Method)
```

```
java.net.SocketInputStream.read(SocketInputStream.java:129)
```

```
org.postgresql.core.VisibleBufferedInputStream.readMore(Visib
leBufferedInputStream.java:135)
```

```
org.postgresql.core.VisibleBufferedInputStream.ensureBytes(Vi
sibleBufferedInputStream.java:104)
```

```
org.postgresql.core.VisibleBufferedInputStream.read(VisibleBu
fferedInputStream.java:73)
```

### 12.13.3 Verify Purging of Data from the AWIPS II HDF5 Processed Data Store

The HDF5 Data Store is located in `/awips2/edex/data/hdf5` on dx2f. A “quick and dirty” method of determining data purge is to count the number of files of specific ages in this directory structure. Unlike the LDM-managed AWIPS II Raw Data Store, the AWIPS II HDF5 Processed Data Store is managed primarily via version-based purging. That is, the number of products of a specific data type, rather than the age of the data, is the primary purge mechanism. As a result, there is no way to determine the age of the oldest HDF5 file that we should expect to find. As a quick check, we can find the number of files of various ages; that count should decrease as the age increased.

The steps follow.

1. Open a terminal window on your workstation.
2. Log into dx2f as the *root* user.
 

```
Enter:      ssh root@dx2f
```
3. Change directory to the AWIPS II HDF5 Data Store.
 

```
Enter:      cd /awips2/edex/data/hdf5
```
4. Determine the number of files in the AWIPS II HDF5 Data Store.

**Enter:** `find . -type f | wc -l`

Note that this command may take several minutes to execute.

```
37474
```

5. Determine the number of files in the AWIPS II HDF5 Data Store that are more than one, two, three, and four days old.

**Enter:** `find . -mtime +1 -type f | wc -l`

```
8930
```

**Enter:** `find . -mtime +2 -type f | wc -l`

```
8591
```

**Enter:** `find . -mtime +3 -type f | wc -l`

```
8124
```

**Enter:** `find . -mtime +4 -type f | wc -l`

```
7686
```

**Note:** Each command may take several minutes to execute.

6. Log off dx2f.

**Enter:** `exit`

7. Expected results: If the purge of the AWIPS II HDF5 Data Store is set up and executing, each `find | wc -l` command should show fewer files.

### 12.14 Triggers

Triggers are maintained in AWIPS II basically in the same way they are maintained in AWIPS I – through the `/data/fxa/siteConfig/textApps/siteTrigger.template` file. The structure of this file has not changed from AWIPS I.

1. Triggers run as user *awips* from within edex on dx3 and dx4.
2. The product files are written to `/awips2/edex/data/fxa/trigger`; therefore, most triggers scripts will have to be changed for this new directory. This directory is only available on dx3, dx4, px1, and px2.
3. Use the `config_awips2.sh` script to invoke changes to the `siteTrigger.template` file. Refer to the *AWIPS II Site Migration Guide* for instructions on running `config_awips2.sh`.

4. siteTrigger.template file will likely be a symbolic link to an AWIPS I/II-specific file. Make sure you are changing the appropriate file for AWIPS I/II use.
5. The location of your trigger script on the system has changed from AWIPS I. All local application programs and scripts are recommended to be in /localapps/runtime. This is a long-term goal. At present, it is not a hard requirement when initially switching to running AWIPS II operationally. All AWIPS I directories such as /data/local and /awips/dev remain unchanged when running AWIPS II.
6. When porting AWIPS I trigger scripts, it is like that there will be no need to set environment variable FXA\_HOME or source readenv.(c)sh. These should be removed from the scripts.

Triggers in AWIPS II are run as edex [Subscriptions](#) and not as postgres database triggers. The subscription command should not be used to add or delete triggers. Use siteTrigger.template and config\_awips2.sh.

### 12.14.1 Environmental Variables

Trigger scripts will likely inherit a limited environment; therefore, trigger scripts must explicitly set what the script will need. Most of the environment settings that are needed to run AWIPS-specific programs are defined in /etc/profile.d. You can examine them to determine what your application needs are and source accordingly. Otherwise, to get the default environment for the user the script is running as, add the "-l" (lower case L) option to the shell invocation on the first line of the script:

```
#!/bin/sh -l
```

or for csh:

```
#!/bin/csh -l
```

This forces reading system wide settings in /etc/profile.d and user settings in \$HOME/.bashrc, .cshrc, .login, etc.

**Note:** For user fxa, the default shell is csh, so a user who is running a bash script will not get .cshrc settings in /awips/fxa/.cshrc. The user might have to create a .bashrc file to further set up the environment.

Use the -l option only as a last resort if you cannot find the specific environment variables you need.

For cron or trigger scripts that run perl, python, tcl, etc. directly, you might have to wrap in a shell script and have the shell script set up the environment:

```
#!/bin/sh -l
export TZ=EST5EDT
exec /localapps/runtime/bin/myApp.tcl > myLogFile 2>&1
```

Baseline programs such as textdb, gfeclient, runProcedure, etc. should set up the necessary environment they need to run. If you have problems running these from cron or triggers due to environment problems, open a ticket. Note that the path setting to these programs may still need to be set:

```
textdb -r PIL - might not work because of PATH setting
/awips/fxa/bin/textdb -r PIL - should always work.
```

### 12.14.1.1 Logging

To send output of a trigger script to a log file, use a wrapper script like the one in the example above. This will capture errors in the script as well as any normal output.

It is recommended that sh (bash) scripts be used instead of csh. If using an sh script, you can redirect stdout and stderr to a log file directly within the script using the “exec” statement.

### 12.14.1.2 Migrating AWIPS I to AWIPS II

Follow the steps in section 5, Automation Tool (config\_awips2), in the *AWIPS II Site Migration Guide*.

### 12.14.1.3 Viewing Current Triggers in AWIPS II

You can view your current AWIPS II triggers/subscriptions via the following command:

```
/awips2/fxa/bin/subscription -o read -p pil
```

**Note:** The subscription does have other commands as well.

### 12.14.1.4 Updating Triggers in AWIPS II

As root, ssh to DX1

- Update dx1:/data/fxa/siteConfig/textApps/siteTrigger.template
  - Remove any triggers that are no longer relevant.
  - Update any script locations which may have changed.
- cd /data/fxa/sdc (as root on DX1)
- ./config\_awips2.sh -f triggers XXX (where XXX is your 3-letter site ID in CAPS)

**Note:** The -f will purge and repopulate the triggers with national triggers as well as your siteTrigger.

- Once the script is completed, you will need to bounce the asyncScheduler on px1 to append the asyncScheduler triggers. To do this:

- As user fxa on PX1f
  - stopAsyncScheduler
  - startAsyncScheduler
- When done, an output copy of the triggers is located in dx1:/var/tmp/awipsTriggersSetup.txt

### 12.15 Text Triggers

The Text Triggers utility monitors the text data stream and matches a set of predefined product PILs based on the old AFOS PILs, against the data being inserted into the **fxatext** database. A template contains the PILs to be detected; it is refined using configuration files that contain text-product strings. Text Triggers allow processing of the data by processes that are not monitoring the raw data input stream and that may desire locally generated text products (which may or may not be distributed outside of the local office) in addition to products from the Satellite Broadcast Network.

Text Triggers can be invoked for processing by the following AWIPS functional areas:

- LDAD (for the site, and for site backup)
- ADAPT
- Fax
- Local triggers

The LDAD triggers are generated using a site-specific configuration file in conjunction with a template file.

Fax triggers are set by the text workstation user, and local-products triggers are created from site-generated files.

In all cases, the PIL is passed as the last argument to the script.

The following environmental variables and their corresponding definitions are used in this section.

\$FXA_DATA	/data/fxa
\$FXA_HOME	/awips/fxa
\$FXA_CUSTOM_FILES	/data/fxa/customFiles
\$FXA_LOCALIZATION_SCRIPTS	/awips/fxa/data/localization/scripts

#### 12.15.1 Configuring Text Triggers

Text Trigger templates provide a list of products and formats for sites to follow and build upon in setting up their own sites' triggers. These templates are usually found in the **\$FXA\_DATA/nationalData** directory, with the notable exceptions of the facsimile (fax)



and local site triggers. Table 12.15.1-1 lists some of these template types and the paths to their respective files. These template types are discussed in the following subsections.

**Note:** The Hydro Triggers in AWIPS I has been re-engineered into AWIPS II.

**Table 12.15.1-1. Text Trigger Template Files**

Trigger Template Type	Trigger Template Full Path and File Name
ADAPT	\$FXA_DATA/nationalData/adaptTrigger.template \$FXA_DATA/nationalData/adaptTriggerAll.template
LDAD	\$FXA_DATA/nationalData/ldadTrigger.template
LDAD Site Backup	\$FXA_DATA/nationalData/ldadSiteBackupTrigger.template
Facsimile (Fax)	\$FXA_DATA/workFiles/fax/<LLL>-faxTrigger.template
Local Site Text Triggers	\$FXA_DATA/siteConfig/textApps/siteTrigger.template

### 12.15.1.1 ADAPT Text Triggers

The Meteorological Development Laboratory uses Text Triggers for ADAPT. ADAPT ingests all the SAW and SEV products stored in the database for display within WWA and the ZFP, DSM, and CCF products for designated WFOs.

Messages to be detected are defined in the file

**\$FXA\_HOME/data/localization/<LLL>/<LLL>-adaptSiteConfig.txt**, where <LLL> is the site's localization ID, usually the same as the site ID. Each distinct entry is a single line with the following format:

**www <old\_AFOS\_ID>**

Where

**www** is a literal string, and

**<old\_AFOS\_ID>** is a variable three-letter string that identifies the old AFOS ID of the WFO whose messages are to be detected.

You can edit the **<LLL>-adaptSiteConfig.txt** file to add as many entries as you like. The following is an example of an **<LLL>-adaptSiteConfig.txt** file with four distinct entries:

```
www   WBC
www   PHL
www   CRW
www   PIT
```

The Text Triggers utility reads **<LLL>-adaptSiteConfig.txt** and automatically constructs the AFOS PILs to be detected.

These products are brought in via **fxaTextTriggerActions** entries copied from the file **/data/fxa/nationalData/adaptTriggerAll.template**:

```
CCCSAWXXX | | | /awips/adapt/ifps/bin/linux/ingest_saw-lx.bat |
CCCSSEVXXX | | | /awips/adapt/ifps/bin/linux/ingest_sev-lx.bat |
```

```

CCCWCLXXX | | | /awips/adapt/ifps/bin/linux/ingest_wcl-lx.bat |
CCCWOUXXX | | | /awips/adapt/ifps/bin/linux/ingest_wou-lx.bat |
CCCTCVXXX | | | /awips/adapt/ifps/bin/linux/ingest_tpc-lx.bat |

```

ZFP products are used to create the Surface Area Forecast (SAF) read on the NOAA Weather Radio, and the local ASOS summary messages are used by the Climate program; all of these products are brought in via the `~nationalData/adaptTrigger.template` file, which contains the following entries:

```

wwwDSMXXX | | | /awips/adapt/climate/bin/LINUX/ASOS_smDecoder.sh |
wwwMSMXXX | | | /awips/adapt/climate/bin/LINUX/ASOS_smDecoder.sh |

```

where the `www` directive(s) are set in the `<LLL>-adaptSiteConfig.txt` file and `<LLL>` represents the localization ID, which is usually the same as the site ID. Both `CCC` and `XXX` are wildcards.

The contents of the `$FXA_LOCAL_SITE-wsoTrigger.template` file, if one exists, are also added to the `$FXA_HOME/postgres/fxatextTriggerActions.txt` file. This addition provides access to non-AWIPS NWS sites' (Alaska Region) products in the WWA monitor. An example of the added products follows.

```

JNUWSWANN | | | /awips/adapt/ifps/bin/linux/ingest_wso_lx.bat |
JNUWSWYAK | | | /awips/adapt/ifps/bin/linux/ingest_wso_lx.bat |
ANCWSWADQ | | | /awips/adapt/ifps/bin/linux/ingest_wso_lx.bat |
ANCWSWAKN | | | /awips/adapt/ifps/bin/linux/ingest_wso_lx.bat |
FAIWSWOME | | | /awips/adapt/ifps/bin/linux/ingest_wso_lx.bat |
FAIWSWOTZ | | | /awips/adapt/ifps/bin/linux/ingest_wso_lx.bat |
JNUNPWANN | | | /awips/adapt/ifps/bin/linux/ingest_wso_lx.bat |
JNUNPWYAK | | | /awips/adapt/ifps/bin/linux/ingest_wso_lx.bat |
ANCNPWBET | | | /awips/adapt/ifps/bin/linux/ingest_wso_lx.bat |
ANCNPWCDB | | | /awips/adapt/ifps/bin/linux/ingest_wso_lx.bat |
ANCSPSADQ | | | /awips/adapt/ifps/bin/linux/ingest_wso_lx.bat |
ANCSPSAKN | | | /awips/adapt/ifps/bin/linux/ingest_wso_lx.bat |
FAISPSOME | | | /awips/adapt/ifps/bin/linux/ingest_wso_lx.bat |

```

### 12.15.1.2 LDAD Text Triggers

The `$FXA_HOME/postgres/fxatextTrigger.sh` script sets up the LDAD Text Triggers in the text database to send specified text data to the LDAD system. The script reads a data file containing the required product IDs (AFOS PILs) and associated actions. This file is created by the localization routine `fxatextTriggerConfig.sh` and is found in `$FXA_HOME/postgres/fxatextTriggerActions.txt`.

An example of the **\$FXA\_HOME/postgres/fxatextTriggerActions.txt** output is

```
SFORVISTO | | | /awips/fxa/ldad/bin/textdbNotify.pl statement |
SFOSHPSTO | | | /awips/fxa/ldad/bin/textdbNotify.pl report |
SFOSHISTO | | | /awips/fxa/ldad/bin/textdbNotify.pl report |
SFOSMASTO | | | /awips/fxa/ldad/bin/textdbNotify.pl warning |
SFOSPFSTO | | | /awips/fxa/ldad/bin/textdbNotify.pl forecast |
SFOSWOSTO | | | /awips/fxa/ldad/bin/textdbNotify.pl outlook |
```

The **\$FXA\_DATA/nationalData/ldadTrigger.template** file contains the LDAD actions, and includes entries like

```
wwwSPSww1 | | | /awips/fxa/ldad/bin/textdbNotify.pl statement |
wwwTORww1 | | | /awips/fxa/ldad/bin/textdbNotify.pl warning |
wwwSVRww1 | | | /awips/fxa/ldad/bin/textdbNotify.pl warning |
wwwFFAww1 | | | /awips/fxa/ldad/bin/textdbNotify.pl watch |
wwwSTPsss | | | /awips/fxa/ldad/bin/textdbNotify.pl report |
rrrFFGsss | | | /awips/fxa/ldad/bin/textdbNotify.pl outlook |
wwwSMAww1 | | | /awips/fxa/ldad/bin/textdbNotify.pl forecast |
```

The **www**, **ww1**, **sss**, and **rrr** placeholders included in the template are replaced by site-specific locations defined in the

**\$FXA\_HOME/data/localization/<LLL>/<LLL>-ldadSiteConfig.txt** file, where **<LLL>** represents the localization ID, usually the same as the site ID. The file consists of at least four lines, defining each of the directives, as shown in Table 12.15.1.2-1.

**Table 12.15.1.2-1. LDAD Trigger Template File Directives**

Term 1	Term 2	Description of Terms
www	wfo	<b>www</b> is a literal string and <b>&lt;wfo&gt;</b> is a variable three-letter string that identifies the CCC of an AFOS PIL (i.e., the AFOS node, like SFO for site STO).
ww1	wfo	<b>ww1</b> is a literal string and <b>&lt;wfo&gt;</b> is a variable three-letter string that identifies the XXX of an AFOS PIL (i.e., the AWIPS site ID, like STO). It is possible to have the same string as the <b>www</b> or to have a different site identifier for <b>ww1</b> *.
sss	state ID	<b>sss</b> is a literal string and <b>&lt;state ID&gt;</b> is a variable two-letter string that identifies a state (i.e., the state's 2-letter USPS designation, like CA for California).
rrr	rfc	<b>rrr</b> is a literal string and <b>&lt;rfc&gt;</b> is a variable three-letter string that identifies a River Forecast Center.
*The default <b>&lt;LLL&gt;-ldadSiteConfig.txt</b> files do not include a <b>ww1</b> directive. One is added during triggers processing using the value of the <b>FXA_LOCAL_SITE</b> environment variable. If a different <b>ww1</b> is needed, it can be included in a copy of the <b>&lt;LLL&gt;-ldadSiteConfig.txt</b> file placed in <b>\$FXA_CUSTOM_FILES</b> .		

Some sites need to consider products from only one WFO, state, and RFC while others require multiple states and RFCs. Two examples are shown below. One for Tucson [TWC] and one for Pittsburg [PBZ]

```
TWC-ldadSiteConfig.txt
```

```
www PHX
```

```
ww1 TWC
```

```
sss AZ
```

```
rrr SLC
```

```
PBZ-ldadSiteConfig.txt
```

```
www PIT
```

```
ww1 PBZ
```

```
sss PA
```

```
sss OH
```

```
sss MD
```

```
sss WV
```

```
rrr PIT
```

```
rrr CRW
```

It is acceptable for more than one WFO to appear in the `ldadSiteConfig.txt` file, although none of the default files has more than one.

The LDAD site backup trigger capability is identical to the main LDAD trigger configuration except that the backup configuration file is named `<LLL>-ldadSiteBackupConfig.txt` and the template is `$FXA_DATA/nationalData/ldadSiteBackupTrigger.template`.

Actions associated with the backup files are included in the `TriggerActions` file. Even if the current site backup template lacks RFC information, an entry for `rrr` must be present.

**Note:** Individual site backup configuration files are not delivered as part of the AWIPS installation and must be created locally by each site.

### 12.15.1.3 Installing a New *ldad* Trigger

The following steps are needed to install a new `ldadTrigger`

1. Install the trigger in the **`ldadTrigger.template`** file. On DX1 as user **`root`**,

```
TYPE:      cd /data/fxa/sdc
```

```
TYPE      ./config_awips2.sh -f triggers LLL
```

**Note:** `<LLL>` is the localization identifier and `XXX` is your 3-letter site ID in caps. Both of these IDs are usually the same as the site's 3-letter AWIPS ID.

2. Verify DB installation. On DX1, as user **root**,

**TYPE:**        `psql -U awips fxatext`

**TYPE:**        `select trigger, filepath from subscriptions;`

3. The results should look similar to the following:

productid	script
ANCHWOAFC	/awips/fxa/ldad/bin/textdbNotify.pl statement
ANCSVSAFC	/awips/fxa/ldad/bin/textdbNotify.pl statement
ANCTORAFC	/awips/fxa/ldad/bin/textdbNotify.pl warning
ANCSVRAFC	/awips/fxa/ldad/bin/textdbNotify.pl warning
ANCFFAAFC	/awips/fxa/ldad/bin/textdbNotify.pl watch
ANCFFWAFC	/awips/fxa/ldad/bin/textdbNotify.pl warning
ANCFESAFC	/awips/fxa/ldad/bin/textdbNotify.pl statement
ANCRFWAFC	/awips/fxa/ldad/bin/textdbNotify.pl warning
ANCFLSAFC	/awips/fxa/ldad/bin/textdbNotify.pl statement
ANCFLWAFC	/awips/fxa/ldad/bin/textdbNotify.pl warning
ANCWSWAFC	/awips/fxa/ldad/bin/textdbNotify.pl warning
ANCNPWAFC	/awips/fxa/ldad/bin/textdbNotify.pl forecast
ANCLFPAFC	/awips/fxa/ldad/bin/textdbNotify.pl forecast
ANCSFPAK	/awips/fxa/ldad/bin/textdbNotify.pl forecast
ANCFZPAK	/awips/fxa/ldad/bin/textdbNotify.pl forecast
ANCFR1AFC	/awips/fxa/ldad/bin/textdbNotify.pl report

4. Exit the database.

**TYPE:**        `\q`

**Result:** The user should see a prompt similar to the following that lets the user know that he/she exited the database:

**[root@dx1-tbw4 bin]\$**

5. Look in the `/awips/fxa/postgres/fxatextTriggerActions.txt` file for the HWO product line, which should look similar to the following:

WBCHWOLWX | | | /awips/fxa/ldad/bin/textdbNotify.pl statement |

6. Using the product that you see in the `fxatextTriggerActions.txt` file, create an entry in the `fxatext` database. The following is an example:

**TYPE:**        `textdb -w WBCHWOLWX`

**TYPE:**        `This is a test`

**TYPE:** [Ctrl-d]

- To check that the product has been triggered, grep for the product in the edex-ingest-  
<date>.log file on all EDEX servers

```
grep WBCHWOLWX /awips2/edex/logs/edex-ingest-<date>.log
```

You should see entries with “LdadMicroEngine:” indicating that EDEX has spawned the script for that trigger.

#### 12.15.1.4 Facsimile (fax) Text Triggers

Text Triggers can be configured to transmit a facsimile automatically when an AFOS PIL is detected. Using the **Configure Auto Fax** interface on the text workstation, a user can set up a list of products that are to be sent by fax upon receipt. This list of products is stored in `$FXA_DATA/workFiles/fax/<LLL>-faxTrigger.template` and is inserted directly in the `fxatextTriggerActions.txt` file after being modified to fit the `TriggerActions` file’s format.

#### 12.15.1.5 Local Site Text Triggers

Local site text triggers should be placed in the file `$FXA_DATA/siteConfig/textApps/siteTrigger.template`. These triggers are handled in the same way as the fax triggers – simply expanded to fit the `TriggerActions` format. Each entry consists of a single line listing the product PIL and the full path name of an executable to be invoked when the product is stored. You can create `siteTrigger.template` and add as many entries as you would like.

The following is an example of the `siteTrigger.template` file:

```
NMCRRMWY      /data/fxa/siteConfig/textApps/snotel/decodeSNOTEL.csh
DENFWCTAD     /data/fxa/siteConfig/textApps/tempfcst/tempfcst.csh
DENAFDDEN     /data/fxa/siteConfig/textApps/collector/collectafd.csh
DENALGDEN     /data/fxa/siteConfig/textApps/collector/collectalg.csh
DENTAPDEN     /data/fxa/siteConfig/textApps/collector/collecttap.csh
DENRR3DEN     /home/andersen/scripts/decodeRR3s.pl DENRR3DEN
DENRR3GJT     /home/andersen/scripts/decodeRR3s.pl DENRR3GJT
DENRR3PUB     /home/andersen/scripts/decodeRR3s.pl DENRR3PUB
DENRR1GJT     /home/andersen/scripts/decodeRR3s.pl DENRR1GJT
DENRR2DEN     /home/andersen/scripts/decodeRR3s.pl DENRR2DEN
DENRR2ALS     /home/andersen/scripts/decodeRR3s.pl DENRR2ALS
TOPRR3GLD     /home/andersen/scripts/decodeRR3s.pl TOPRR3GLD
DENSTPCO      /home/andersen/scripts/decodeRR3s.pl DENSTPCO
SLCSTPUT      /home/andersen/scripts/decodeRR3s.pl SLCSTPCO
```

```
DENSPSDEN /data/fxa/siteConfig/textApps/sigwx/sigwx.pl
```

```
DENWRKRR1 /home/andersen/scripts/decodeMtnstates.pl
```

**Note:** Any script that is created for the local triggers should take the AFOS PIL of the product as the final argument.

## **Chapter 13**

### **Event Notification**



## Chapter 13. Event Notification

### Table of Contents

	<i>Page</i>
13.1 Description of Text Alarm/Alert Capability.....	1

### List of Exhibits

Exhibit 13-1. Text Workstation User Interface.....	1
Exhibit 13.1-1. default.xml Alarm/Alert and Proximity Alarm Products GUI .....	2
Exhibit 13.1-2. default.xml Alarm/Alert and Proximity Alarm Product GUI Error Message.....	4

The text workstation can be configured to monitor the **fxatext** database for arrival of certain products, for specific content of selected products, or for products whose valid area intersects a defined area of interest. The Text Alarm/Alert capability is accessed through the text workstation user interface, as shown in Exhibit 13-1 (refer to Section 5.4 of the *AWIPS CAVE-D2D User's Manual* for guidance on working with Alarm/Alert features).



**Exhibit 13-1. Text Workstation User Interface**

The Text Alarm/Alert capability allows the user to select text products to be alarmed (sound) or alerted (no sound). A flashing bell at the upper left corner of the screen appears when a product of interest is received, optionally accompanied by a sound. A click on the bell silences the alarm (if on) and opens a dialog containing the product name(s). The user can display the product by clicking on it with the mouse.

### **13.1 Description of Text Alarm/Alert Capability**

The list of text products to monitor is built from four files; two of them are controlled by the system manager and the other two can be defined and edited by any AWIPS user. In each case, one file is for the Alarm/Alert function, and the other is for the new Proximity Alarm capability. The list of Text Alarm/Alert products and Proximity Alarm products is presented to the user in a combined user interface (UI), as shown in Exhibit 13.1-1.

To display the Alarm/Alert and Proximity Alarm Products GUI, as shown in Exhibit

13.1-1:

1. Click on the Alarm Alert button in the Text Workstation GUI.
2. Click on the Product List button in the Current Alarm Queue GUI.

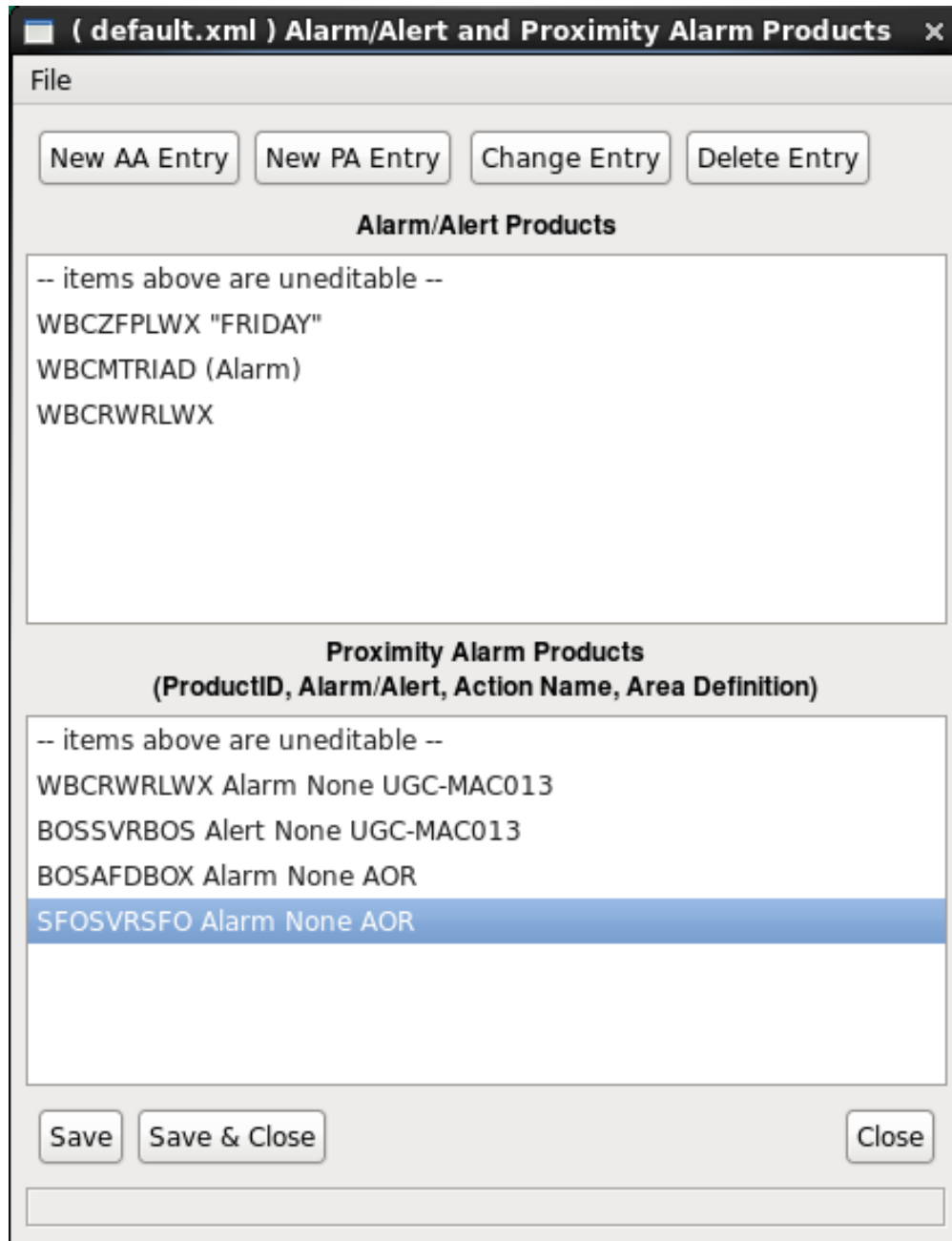

**Exhibit 13.1-1. default.xml Alarm/Alert and Proximity Alarm Products GUI**

- In Exhibit 13.1-1, if any products (currently not shown) are available in the **default.xml** window (the upper window of the UI), above the line that reads “*--items above are uneditable--*,” are defined by the system manager and cannot be modified. [Note: The alarm files should be maintained through the Localization Perspective,

where a **DefaultSiteAlarms.xml** file can be established on a site, per-workstation, or per-user basis.]

- Any products listed in the **default.xml** window of the UI below the line that reads “*--items above are uneditable--*” are user-defined and user-editable using the Text Alarm/Alert UI. This product list resides in the **/awips2/edex/data/utility/common\_static/user/<uname>/alarms/default.xml** file, where **<uname>** is the user’s login name. Note that the file is maintained on the EDEX cluster (DX 3/4) and is copied to **/home/<uname>/common/user/<uname>/alarms**.
- In Exhibit 13.1-1, if any products (currently not shown) are available in the Alarm/Alert and **Proximity Alarm Products** window displayed (the lower window of the UI) above the line that reads “*--items above are uneditable--*,” are defined by the system manager and cannot be modified via the Text Alarm/Alert UI. [**Note:** The alarm files should be maintained through the Localization Perspective, where a **DefaultSiteAlarms.xml** file can be established on a site, per-workstation, or per-user basis.]
- If any products are listed in the **Proximity Alarm Products** window of the UI below the line that reads “*--items above are uneditable--*,” these products are user-defined and user-editable using the Text Alarm/Alert UI. This product list resides in the **/awips2/edex/data/utility/common\_static/user/<uname>/alarms/default.xml** file, where **<uname>** is the user’s login name. Note that the file is maintained on the EDEX cluster (DX 3/4) and is copied to **/home/<uname>/caveData/common/user/<uname>/alarms**

If the user attempts to select any of the entries in the system manager-controlled list, an error message stating that it is not allowed is displayed at the bottom of the window, as shown in Exhibit 13.1-2.

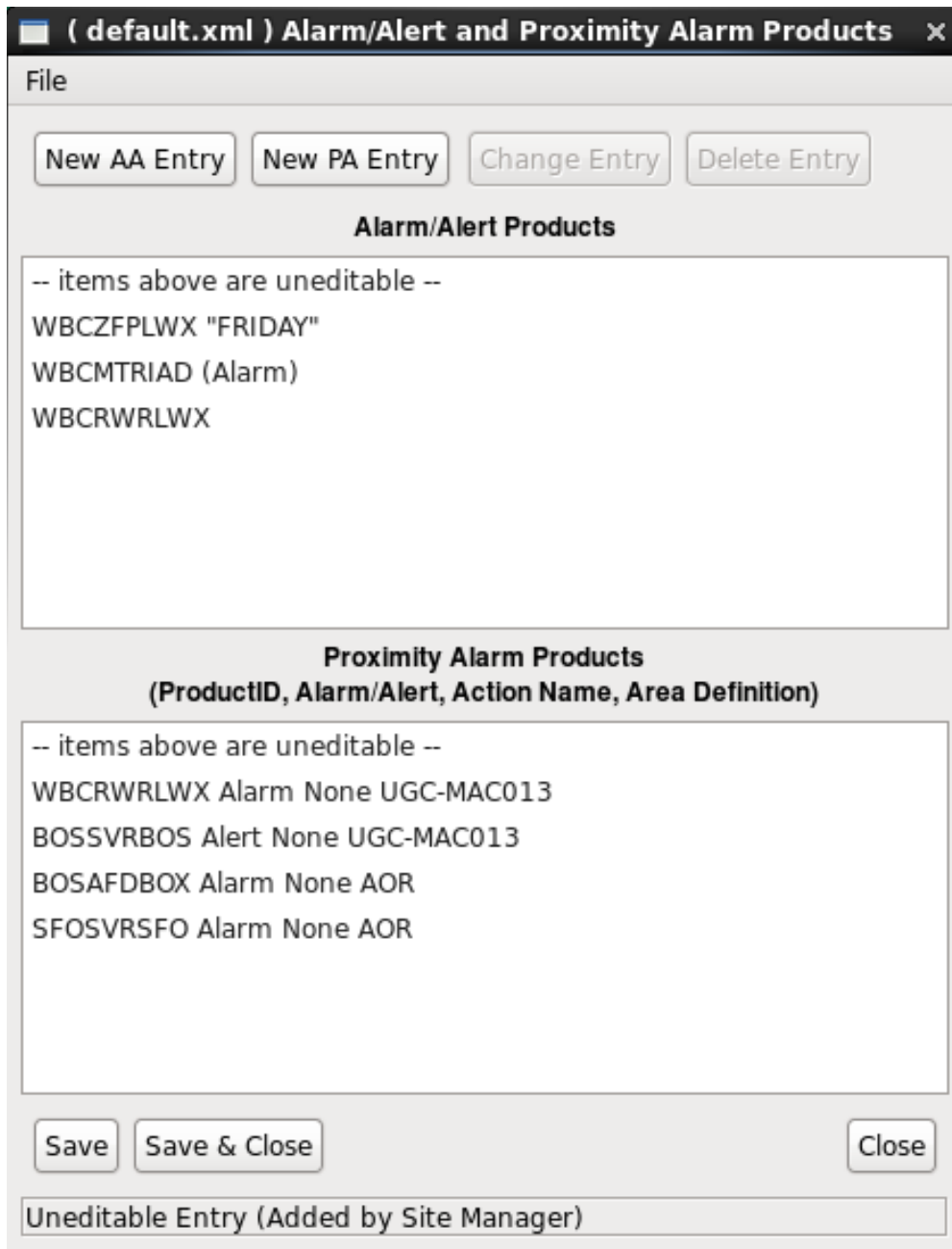

**Exhibit 13.1-2. default.xml Alarm/Alert and Proximity Alarm Product GUI Error Message**

Users can elect to save their list of user-controlled Alarm/Alert products for later recall; the file is saved on the EDEX cluster in **\$EDEX\_HOME/data/utility/common\_static/user/<uname>/alarms/default.xml**. The user-defined file name will appear in the window title bar (i.e., referring to Exhibits 13.1-1 and 13.1-2); “init” in the window title bar would be replaced by the user-defined file name, if any. This way, users and system managers know what file is controlling the alarm/alert function.

# **Chapter 14**

## **Message Handling System**

## Chapter 14. Message Handling System

### Table of Contents

		<i>Page</i>
14.1	SBN Retransmission .....	1
14.2	Administrative Message Handling System .....	2
	14.2.1 MHS Environment Variables, Directories, and Configuration Files .....	2
	14.2.1.1 MHS Environment Variables and Values (on all DX1 as user fxa) .....	2
	14.2.1.2 MHS Administrative Directories .....	3
	14.2.1.3 MHS Configuration Files .....	3
14.3	MHS Receiver Processing .....	3
14.4	Address Expansion .....	5
	14.4.1 NCF Administrative Messages .....	6
	14.4.1.1 Troubleshooting and Monitoring Commands .....	7
	14.4.1.1.1 Troubleshooting .....	7
	14.4.1.1.2 Monitoring Commands .....	8
14.5	Site Level Illustration .....	8

### List of Exhibits

	Exhibit 14.5-1. Receive Distributed Product and Send Acknowledgment .....	9
	Exhibit 14.5-2. Distribute Product and Receive Acknowledgement .....	10

### List of Tables

	Table 14.3-1. Message Handlers .....	4
	Table 14.3-2. Key Words in Handling Specifications .....	4

The deployment of an SMTP protocol enables users to distribute text, grid, and radar imagery products efficiently and accurately among the AWIPS sites, via the terrestrial WAN.

To verify that the SMTP Message Handling System (MHS) processes are running, on DX1:

**TYPE:** `ps -wef|grep smtp`

- You should see output similar to the following:

```
root      29944      1  0 Jul11 ?          00:00:06 mdp_daemon -k 7789 -f
/awips/ops/data/mhs/mdp-smtp.cfg

awipsmhs 29945 29944  0 Jul11 ?          00:18:26 smtp_send -eb -cz -k7789
-n0 -p/tmp/smtp0_send_fifo

awipsmhs 29971      1  0 Jul11 ?          00:00:10 smtp_recv -n0 -m0 -
o/data/mhs/smtp_recv/output - b/var/spool/mail/awipsmhs
```

### 14.1 SBN Retransmission

SBN Retransmission provides the capability for a site to automatically request retransmission of missed NWS Telecommunications Gateway (NWSTG) products from the Network Control Facility (NCF). Retransmission is intended to handle short-term data loss situations; it is not intended to provide data replenishment for long-term outages.

SBN Retransmission is enabled by default. In addition, CPSBN reboots re-enable retransmission. **Note:** All channels except GOES support automatic retransmission. GOES does not because the NCF software does not support it.

When the site's CPSBN1 determines that an interruption in NWSTG product receipt has occurred, a retransmission request is automatically transmitted over the WAN to the NCF. The CPSBN determines if an interruption has occurred by detecting gaps in the NCF-assigned product sequence numbers. For example, if product number 870 follows 865, a retransmission request for products 866, 867, 868, and 869 is automatically issued.

Once the NCF receives the retransmission request, the requested range of missing NWSTG data will be retransmitted over the SBN to every site. The site responsible for the retransmission request ingests the products as "RETRANS." Sites that already have these products will discard them as duplicates. There will be occasions, however, when products will arrive at a nonrequesting site and be processed as first-time products. This duplicate processing may occur if a communications processor (CP) has recently been restored or spared over. To avoid excessive WAN traffic, retransmission requests from a single site are sent at a minimum interval of 30 seconds.

The number of products retransmitted by the NCF depends on two items: the number of products requested; and the number of product requests already in the site's outstanding product retransmit request table. Currently, the default is 10,000 products for a single request and at most 15,000 products queued for a site. As requested products are retransmitted, the associated outstanding product request is deleted from the request table.



This default configuration can be increased manually to accommodate increased product volumes during the anticipated 15- to 20-minute solar outage periods (i.e., 20,000 products for a single request and at most 20,000 products queued). Site requests that exceed these maximum values are normally logged at the NCF but discarded. An alarm is generated to notify NCF operators that site replenishment may be required.

**NOTE:** Data collected thus far indicate that sites typically request fewer than 2,000 products, so large requests (over 5,000 products) do not occur frequently. Retransmission requests are not issued for problems such as power failures or reboots.

## 14.2 *Administrative Message Handling System*

The AWIPS WAN provides the full connectivity AWIPS sites required to exchange data.

Use of the text workstation to produce, send, and display received administrative messages is described in the AWIPS CAVE-D2D User's Manual.

All products sent to the default NCF address may be disseminated over the Satellite Broadcast Network (SBN), the National Digital Forecast Database (NDFD), NWSTG, the National Weather Wire Service (NWWS), ALL (via WAN), and/or the Radar Multicast, depending on the product. The default address table at the NCF determines what products are forwarded where, based on the WMO header. Currently, all warning products from the NWSTG are transmitted on the SBN, NWWS and the WAN.

In the event of an SBN failure, a selected set of products, defined by NWS Headquarters, will be transmitted via the WAN until the SBN is back up. The current set of products is provided in Appendix H.

### 14.2.1 *MHS Environment Variables, Directories, and Configuration Files*

The MHS data is configured and installed as part of the AWIPS install (or upgrade) procedure.

#### 14.2.1.1 *MHS Environment Variables and Values (on all DX1 as user fxa)*

<b>Variable</b>	<b>Value</b>
\$PROJECT	/awips/ops
\$PATH	/awips/ops/bin:\$PATH
\$SHLIB_PATH	/awips/ops/sharedlib
\$FXA_DATA	/data/fxa

### 14.2.1.2 MHS Administrative Directories

```
$FXA_DATA/mhs  
$FXA_DATA/mhs/enclosures/outfiles
```

The **outfiles** directory is the only directory actively used, and it is the location for user-created attachments (enclosures) for outgoing administrative messages. Users may either create attachments or copy existing attachments here in this directory.

The **enclosures** directory is scoured once a day by the fxa crontab removing products that are more than 30 days old.

### 14.2.1.3 MHS Configuration Files

Several configuration files dictate how a received message will be processed. These files are located in **/awips/ops/data/mhs**, on the server that hosts MHS (dx1f for field sites, mh[1-6] at ANCF and BNCF). These files are:

- ack\_handler.tbl
- addr\_handler.tbl
- all\_sites.data
- default\_addr.data
- dfltaddr.\*
- nack\_handler.tbl
- rcv\_handler.tbl

## 14.3 MHS Receiver Processing

When a message is received by MHS, the first action taken is to attempt to resolve the destination. For messages sent to the AWIPS field sites, the specified destination address will always match the site ID of the recipient. This is rarely the case for messages received by the NCF, so additional steps must be taken to determine how to process these messages. If the destination is the same as the current site ID, then no additional resolution is needed and the message can be processed using the receive handler table (**/awips/ops/data/mhs/rcv\_handler.tbl**). This file tells MHS how to process an incoming message based on the message code provided by the sender. The message code is specified using the “-c” option to message send. With the Java API, it is provided either as a parameter to the MhsMessage class constructor, or by using the setActionCode method. It is important to note that the sender must provide all message details as defined in the receive handler table, or the message may be discarded or processed incorrectly by recipients.

For each message code, the receive handler table defines the destination directory for any attachments, a handler, and the handler specification. If DEFAULT is specified as the

queue directory, enclosures will be stored in the /data/x400/msg/inbox/%MSGTYPE directory, where %MSGTYPE is the sender-passed message type string (“routine” by default). The four valid handlers and their descriptions are described in Table 14.3-1.

**Table 14.3-1. Message Handlers**

Handler	Description
DEFAULT	Save attachment(s) in the specified queue directory. Any file handling specification is ignored.
NULL	Discard attachments and ignore any handling specification.
SYS	Save attachment(s) in the specified queue directory and execute a system call as specified in the handling specification.
PIPE (pipename)	Save attachment(s) in the specified queue directory and write a message using the handling specification to the specified named pipe.

The handling specification can contain the following key words prefixed with the ‘%’ character that are taken from the MHS message as shown in Table 14.3-2.

**Table 14.3-2. Key Words in Handling Specifications**

Key Word	Description
MSGID	The MHS message ID
MSGTYPE	Sender-assigned message type (msg_send -t option)
MSGCODE	Sender-assigned message code (msg_send -c option)
SUBJECT	Sender-assigned message subject (msg_send -s option)
SENDERS	Sending site ID code (e.g. - Miami’s site code is MFL)
PRIORITY	Sender-assigned message priority (msg_send -p option)
BODY	Path to a file containing the contents of the message body (msg_send -b option)
ENCLIST	Comma-separated list of file paths for message enclosures (msg_send -e option)
ENCLOSE(N)	Path to file containing the Nth enclosure
TOTENC	Total number of enclosures
X400DOC	Path to X.400 document file

The following is an example entry in the receive handler table.

```
42 /data/fxa/workFiles/nwws/rcvq
PIPE(/data/fxa/workFiles/nwws/nwws_mhs_pipe) \
%SUBJECT %ENCLOSE(1)
```

This line is for processing a message assigned code 42, which is for weather wire (NWWs) products at field sites that have NWWs uplink systems.

MHS will save attachments to /data/fxa/workFiles/nwws/rcvq. The attachments will have a file name matching the MHS message ID assigned by the originating site when it was submitted and an extension of a three-digit numeric string representing the attachment number in the order specified. So the first attachment for message ABQ-123456 would be

named ABQ-123456.001 and would be stored in /data/fxa/workFiles/nwws/rcvq. The PIPE handler indicates that a message will be written to the named pipe /data/fxa/workFiles/nwws/nwws\_mhs\_pipe containing the string that was passed as a subject and the path to the first enclosure. For this to function properly, a separate application must be reading from the specified pipe; if it is not, the operation will fail. The user can also see that a message subject and a single attachment must be provided by the sender.

#### 14.4 Address Expansion

When the specified destination address does not match the current site ID, MHS will attempt to perform address expansion to translate the address, or it will forward the entire message to a different location using the following rules. First, MHS tries to match the specified address with a special address listed in the address handler table (addr\_handler.tbl). For each special address, this file specifies a site ID, a queue directory, a handler, and a handling specification. The handler and the handling specification are the same as described in section 14.3 for the receive handler table. The site ID replaces the special address. The queue directory is a relative path under /data/mhs. Some of the configuration lines in the address handler table are complex and require additional explanation. The special address DEFAULTNCF has the following specification:

```
DEFAULTNCF ANCF DEFAULT FORWARD( DEFAULT )
```

This means that a message addressed to DEFAULTNCF will have its address temporarily changed to ANCF. The message and any attachments will be written to the default directory for the message type (/data/mhs/inbox) and named using the original message ID. The “FORWARD(DEFAULT)” specification indicates that the address expansion will be performed with the default address table (default\_addr.data) using the product ID assigned by the sender. MHS compares every line in the file with the product ID. Address expansion is cumulative. For instance, a product ID of WOUS99 matches the following expressions in the default address table:

```
W* | ALL
* | NWSTG , SBN
```

The result is that the destination address is expanded to “ALL,NWSTG,SBN”.

A product ID of SDUS75 matches:

```
* | NWSTG , SBN
SDUS7? * | INET , !NWSTG
```

A ‘!’ in front of a destination removes it. The !NWSTG address in the second line negates the NWSTG in the first. The resulting expanded address becomes “SBN,INET”.

The addresses like ALL, SBN, NWSTG, and INET are resolved by passing each expanded address through the address handler table a second time. The special addresses SBN, NWSTG, INET, and NDFD all result in message data getting written to special

named pipes for final processing. Each of these pipes is monitored by a separate instance of the `dissem_dist` daemon, which will disseminate the message according to rules in its associated configuration files (`dfltaddr.*`).

The NWWS special address results in the program “`process_nwws`” being executed to send the product to the weather wire interface.

ALL is a special symbol that is remapped to ALLNCF for resolution in the address handler table. It represents a distribution list defined in the file `all_sites.data` and results in the message being transmitted by the message request daemon (`msgreq_svr`) to every site in the list except for the originating site, which is removed from the list automatically.

One unusually complex rule to note is the one used for service backup. These messages are addressed to DEFAULTNCF with message code 21 and have a product ID of SVCBKPIFP. Using the rules already defined in this section, the default address table rule for DEFAULTNCF forces address expansion of SVCBKPIFP, resulting in a final address of ANCF. Because the address matches the site ID, the message code 21 specification in the receive handler table is used to process the message.

#### 14.4.1 NCF Administrative Messages

The NCF sends administrative messages to notify sites about outages, late model runs, or other important information. Sites should have at least one workstation alarmed for these messages. AWIPS administrative messages may be sent as either urgent messages or routine messages. Messages may be set to alarm using the old AFOS PIL.

- ADA: URGENT administrative messages have the following WMO header and message ID:
  - WMO header: NOUS71 KNCF
  - Message ID for Alarm: NCFADANCF
- ADM: Routine administrative messages have the following WMO header and message ID:
  - WMO header: NOUS72 KNCF
  - Message ID for Alarm: NCFADMNCF

Whenever possible, the NCF will advise all or specific sites, NWSTG, and NCEP in advance of activities that might affect service or communications. When the NCF becomes aware of problems that could have an adverse impact on data receipt or site operations, it will transmit advisories to affected sites, including NWS NRS sites, as well as commercial and private entities that have NRS-like capability.

The NCF may send an AWIPS administrative message for outages like the following:

- Circuits to or from the NCF
- MGS
- GINI

- NWSTG
- NCEP model execution
- Point-to-Point network
- Specific NCF functions
- GOES Eclipse periods
- GOES Maneuver

### 14.4.1.1 Troubleshooting and Monitoring Commands

#### 14.4.1.1.1 Troubleshooting

Log files are generally the first things to check when you want to see if the system is functioning properly. The log files are useful for two reasons:

- You can tell if the MHS processes are currently sending and receiving messages. The processes all write information to their log files about the messages they handle. If the log files have been updated recently, then you know that the system is still running.
- You can tell if any of the processes are having problems, because the MHS processes will write error messages to their log files.

Please check the *msgreq\_svr.log* (located at *awips/ops/logs/dx1-<site>/msgreq\_svr.log* and the *msgrcv\_svr.log* (located at *awips/ops/logs/dx1-<site>/msgrcv\_svr.log* with the new transactions and the *MhsServerRequest* log located in */data/logs/fxa/<current day>* folder for updates. E.g.: *MhsRequestServer2032dx1-tbw3000509*

Examples for the above log files follow.

#### **msgrcv\_svr.log**

```
TBW3-5026: NTXX98 KTBW 221013 (/data/mhs/smtp_rcv/output/m000006.doc)
Wed Sep 22 12:28:54 2010 <msgrcv_svr: 9658> Discard OK
  TBW3-5024: Routine to=TBW3, from=TBW3, pri=0 code=42 enc=1 len=69 dly=(0+9952+0)s
  TBW3-5024: NTXX98 KTBW 220943 (/data/mhs/smtp_rcv/output/m000007.doc)
Wed Sep 22 12:28:54 2010 <msgrcv_svr: 9658> Discard OK
  TBW3-5023: Routine to=TBW3, from=TBW3, pri=0 code=42 enc=1 len=69 dly=(0+10853+0)s
```

#### **msgreq\_svr.log**

```
Wed Sep 22 03:43:02 2010 <msgreq_svr:11236> OK request
  TBW3-4992: Routine to=TBW3, from=TBW3, pri=0 code=42 enc=1 len=69
  TBW3-4992: NTXX98 KTBW 220343 (/data/mhs/msgtbl/TBW3-4992.msg)
Wed Sep 22 03:52:18 2010 <msgreq_svr:11253> OK request
  TBW3-4993: Retransmit Request to=RETRANS, from=TBW3, pri=0 code=0 enc=1 len=373
  TBW3-4993: <no_prodid> (/data/mhs/msgtbl/TBW3-4993.msg)
```

### 14.4.1.1.2 Monitoring Commands

- **msg\_stats**

**TYPE:** cd /awips/ops/bin

**TYPE:** msg\_stats

This program displays general information on the status of the processes, and updates the display every few seconds.

The display is divided into three sections: Message Item Information; Process Information; and detailed information on the first and last messages in each of the three queues.

```
MSG STATS v6: HOST dx1-tbw3 SHMRGN 0 SITE=TBW3 Mon Feb 2 14:48:31 2015

=====Message Item Info=====UNLOCKED
SeqNum Total Avail Inuse SendQ RcvQ TimerQ Sents TmOut #Retry
816042 3964 3961 3 0 0 0 0 3
300 0
=====Process Statistics (Outgoing Messages)=====
MHS Process PID QLen State Last MsgID Count Start_Up Last_Msg
msgreq_svr: 11922 0 WAIT MSG TBW3-816041 902590 12/08/14 14:48:03
mdp_daemon: 11918 0 I WAIT MSG TBW3-816041 902587 12/08/14 14:48:03
smtp_send : 11920 0 I WAIT MSG TBW3-816041 902587 12/08/14 14:48:03
sendmail: : 4515 0 I UP 01/27/15
=====Process Statistics (Incoming Messages)=====
MHS Process PID QLen State Last MsgID Count Start_Up Last_Msg
sendmail: : 4507 0 I UP 01/27/15
smtp_recv : 12023 0 I WAIT MSG TBW3-815989 5775 12/08/14 14:43:05
mhd_daemon: 12021 0 I WAIT MSG TBW3-815989 5426 12/08/14 14:43:05
msgrcv_svr: 12013 0 WAIT MSG TBW3-815989 5425 12/08/14 14:43:05
=====
mtd_daemon: 12025 0 I SLEEP 0 12/08/14 --:--:--
=====Throughput Statistics=====
msg/sec (B/sec) current average maximum cum. total
outgoing: 0 ( 0) 0.0 ( 0) 0 ( 0) 0 ( 0)
incoming: 0 ( 0) 0.0 ( 0) 0 ( 0) 0 ( 0)
processed: 0 ( 0) 0.0 ( 0) 0 ( 0) 0 ( 0)
=====Ack/Nack Statistics=====
```

## 14.5 Site Level Illustration

Site Level data flow diagrams for MHS products are presented in Exhibits 14.5-1 and 14.5-2. Descriptions of the various steps in the flows follow each exhibit.

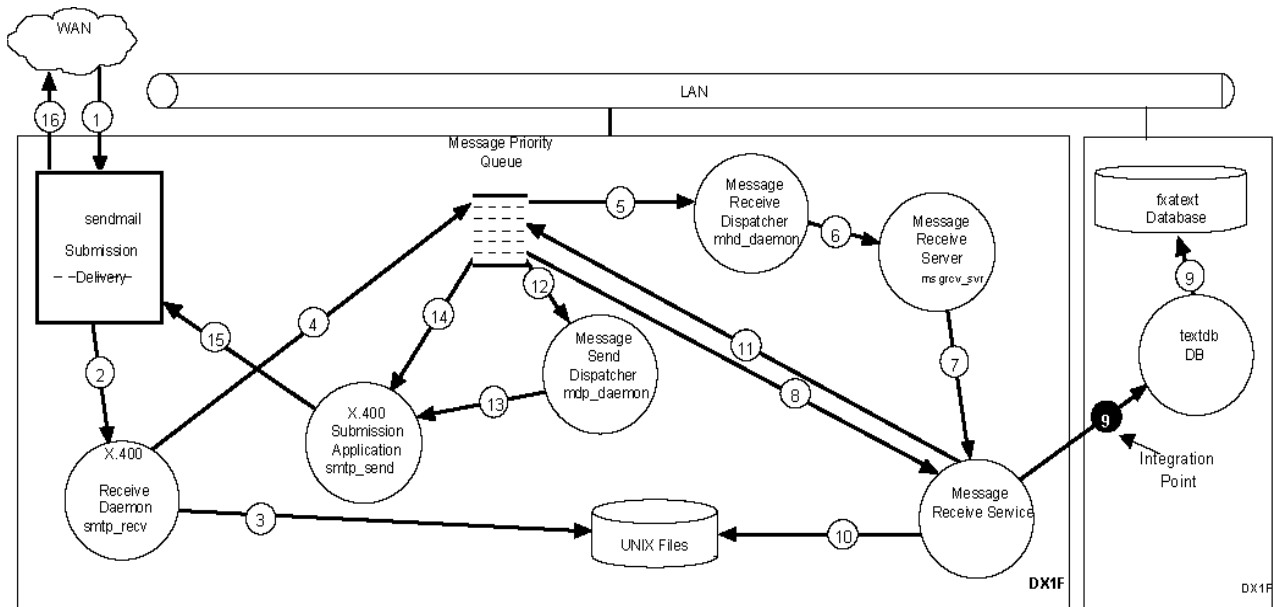

SMM\_07\_18\_11

**Exhibit 14.5-1. Receive Distributed Product and Send Acknowledgment**

As shown in Exhibit 14.5-1,

1. An SMTP session completes between *sendmail* instances at a remote location and the local site. A mail message is written to the *awipsmhs* mailbox file in */var/spool/mail*.
2. The SMTP Receive Daemon (*smtp\_recv*) retrieves the message from the *awipsmhs* mailbox, strips off the SMTP envelope, and extracts the message.
3. The SMTP Receive Daemon stores the message to the local disk.
4. The SMTP Receive Daemon places the message handle and type of message in the Message Priority Queue Shared Memory.
5. The Message Receive Dispatcher (*mhd\_daemon*) retrieves the message handle and message type from the Message Priority Queue Shared Memory.
6. The Message Receive Dispatcher determines that it is a product message and sends a transaction to the Message Receive Server (*msgrcv\_svr*) to process the product message.
7. The Message Receive Server creates a Message Receive Service to handle the message.
8. The Message Receive Service reads the message header information from the Message Priority Queue Share Memory to determine the message type, filename(s), sending site, and whether an acknowledgment is required.
9. The Message Receive Service performs the action specified in the receive handler table (*rcv\_handler.tbl*) by the message code.
10. If requested by the sender, the Message Receive Service queues an acknowledgment to the Message Priority Queue Shared Memory for processing.



11. The Message Send Dispatcher (*mdp\_daemon*) dequeues a message handler from the Message Priority Queue Shared Memory for processing.
12. The Message Send Dispatcher sends the message handle to the SMTP Submission Application (*smtp\_send*).
13. The SMTP Submission Application uses the message handle to access the message header information in the Message Priority Queue Shared Memory.
14. The SMTP Submission Application submits the SMTP message to *sendmail*.
15. The *sendmail* application establishes an SMTP session with all required remote mail servers.
16. The *sendmail* application transmits the message across the WAN.

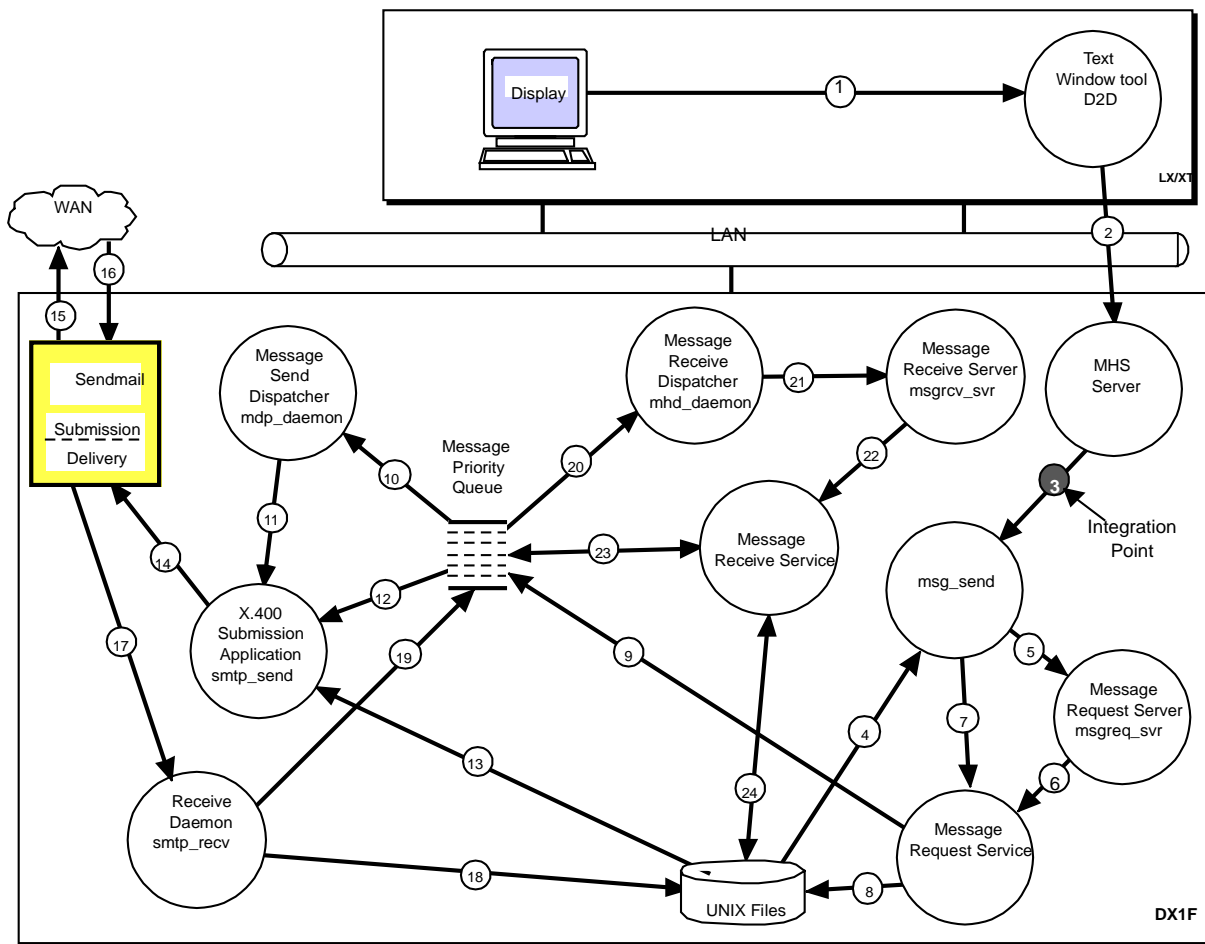

**Exhibit 14.5-2. Distribute Product and Receive Acknowledgement**

As shown in Exhibit 14.5-2,

1. The user selects a message to be sent over MHS via D2D through the Text Window Tool user interface from an XT or LX workstation.
2. The Text Window Tool queues the message for the MHS Server (*MhsServer*).

3. The MHS Server forks and executes a `msg_send` command with all required parameters to queue the message for MHS.
4. The `msg_send` application retrieves the product data from any specified disk files.
5. The `msg_send` application accepts the product distribution request parameters from the user and sends them to the Message Request Server (`msgreq_svr`) as a transaction.
6. The Message Request Server creates a Message Request Service to handle the request.
7. The `msg_send` application writes the product data across the socket to the Message Request Service.
8. The Message Request Service stores the message data into disk files in a predefined directory.
9. The Message Request Service writes the request handle to the Message Priority Queue Shared Memory, along with message header information such as the message type.
10. The Message Send Dispatcher (`mdp_daemon`) determines the message handle of the next message to be dispatched from the Message Priority Queue Shared Memory.
11. The Message Send Dispatcher sends the message handle to the SMTP submission application (`smtp_send`).
12. The SMTP Submission Application uses the message handle to obtain the message header information from the Message Priority Queue Shared Memory.
13. The SMTP Submission Application retrieves the message data contained in the local disk files and builds an SMTP mail message.
14. The SMTP Submission Application submits the SMTP message to sendmail.
15. The local sendmail application establishes remote SMTP sessions to route the message across the WAN.
16. When the SMTP message is successfully delivered to the remote site, an SMTP message containing the acknowledgment is returned to the local `sendmail` and is written to the `awipsmhs` user's mailbox in `/var/spool/mail`.
17. The SMTP Receive Daemon (`smtp_rcv`) reads the message from the `awipsmhs` mailbox, strips off the envelope, and extracts the acknowledgment message.
18. The SMTP Receive Daemon stores the acknowledgment message to disk.
19. The SMTP Receive Daemon places the message request handle and its type in the Message Priority Queue Shared Memory.
20. The Message Receive Dispatcher (`mhd_daemon`) retrieves the message request handle and message type of the next incoming message to be processed from the Message Priority Queue Shared Memory.
21. The Message Receive Dispatcher sends a transaction to the Message Receive Server (`msgrcv_svr`) to process the newly arrived message.

22. The Message Receive Server creates a Message Receive Service to handle the message.
23. The Message Receive Service reads the message header information from the Message Priority Queue Shared Memory to determine which message is being acknowledged. The message being acknowledged is marked as having been acknowledged by the site that sent the acknowledgment. If all sites required to acknowledge the message have acknowledged, then the message entry is deleted from the Message Priority Queue Shared Memory.
24. The Message Receive Service moves the message files to the acknowledgment message inbox directory. If an acknowledgment for the message has been received, the message data files that were written by the Message Receive Service are removed.

# **Chapter 15**

## **Localization**

## Chapter 15. Localization<sup>1</sup>

### Table of Contents

	<i>Page</i>
15.1 <i>Conventions Applied to This Chapter</i> .....	2
15.1.1 General Conventions .....	2
15.1.2 Variable Conventions .....	2
15.2 <i>Radar Localization</i> .....	3
15.2.1 Changing Radar Menus .....	3
15.2.2 Adding or Removing an RPG (Access Configuration Files) .....	6
15.2.2.1 RCM config.xml File .....	6
15.3 <i>WarnGen Localization</i> .....	10
15.3.1 Modifying Default WarnGen GUI Configuration.....	10
15.3.2 Product Templates for WarnGen.....	13
15.3.3 WarnGen Templates .....	15
15.3.3.1 Auxiliary WarnGen Template Files .....	17
15.3.4 Configuration.....	18
15.3.4.1 Configuration Files (.xml).....	18
15.3.4.1.1 Velocity Templates .....	26
15.4 <i>Other Menu Localizations</i> .....	30
15.4.1 Upper Air Menus.....	30
15.5 <i>Baseline Shapefiles</i> .....	31
15.6 <i>Modifying Shapefiles + Areas</i> .....	33
15.7 <i>How to Download Shapefile Data</i> .....	34
15.8 <i>Load and Activate the New Data on AWIPS</i> .....	36
15.9 <i>Downloading Local Shapefiles</i> .....	36
15.10 <i>National Data Management (NDM) Files</i> .....	39

### List of Exhibits

<i>Exhibit 15-1. Localization in AWIPS II</i> .....	1
<i>Exhibit 15.3-1. WarnGen Flow Chart</i> .....	10

### List of Tables

Table 15.1.2-1. Document Variable Conventions .....	3
Table 15.2.1-1. Sections of the radarsInUse.txt File.....	5

---

<sup>1</sup> This chapter is a work in progress.

Table 15.2.2-1. RPG Access Configuration Files.....	6
Table 15.2.2.1-1. Elements of the config.xml File .....	6
Table 15.3.1-1. Localization Fields .....	12
Table 15.3.3-1. WarnGen Severe Weather Product Templates .....	15
Table 15.3.3-2. WarnGen Marine Weather Product Templates .....	15
Table 15.3.3-3. WarnGen Hydrologic Product Templates .....	15
Table 15.3.3-4. WarnGen Non-Warning Product Templates* .....	16
Table 15.3.4.1-1. Field Values.....	18
Table 15.5-1. Shapefiles .....	32
Table 15.6-2. Zone Attributes.....	34
Table 15.7-1. Shapefile Download Commands .....	35
Table 15.10-1. NDM Files Supported by AWIPS II ndm Endpoint.....	39

Localization adapts (i.e., configures) the AWIPS national baseline software to the unique data and display requirements of the site. AWIPS II performs localization dynamically at system startup using data from the localization data environment.

This chapter serves as a guide to changing specific files in the localization environment to configure an EDEX installation to a specific site, and as a guide to adding localization files needed for launching and running client applications such as CAVE and AlertViz. It focuses on a SERVER-CLIENT localization paradigm, much like that which exists on AWIPS I. The steps taken should be sufficient to guide a person familiar with AWIPS I systems through the creation of a usable AWIPS II localization for an EDEX and CAVE instance.

Localization in AWIPS II is done by the EDEX process itself, as opposed to a script (mainScript.csh) from AWIPS I. Based on specific configuration files, the EDEX process produces output files, which are transferred, or downloaded, to the CAVE client when CAVE starts and whenever a change to a file has been detected. Exhibit 15-1 describes the flow of configuration on the left, the localization engine (EDEX) in yellow (center), the output of that localization in orange (top right), and the usage of those localization files via download to a user's caveData directory on a workstation in red (bottom right).

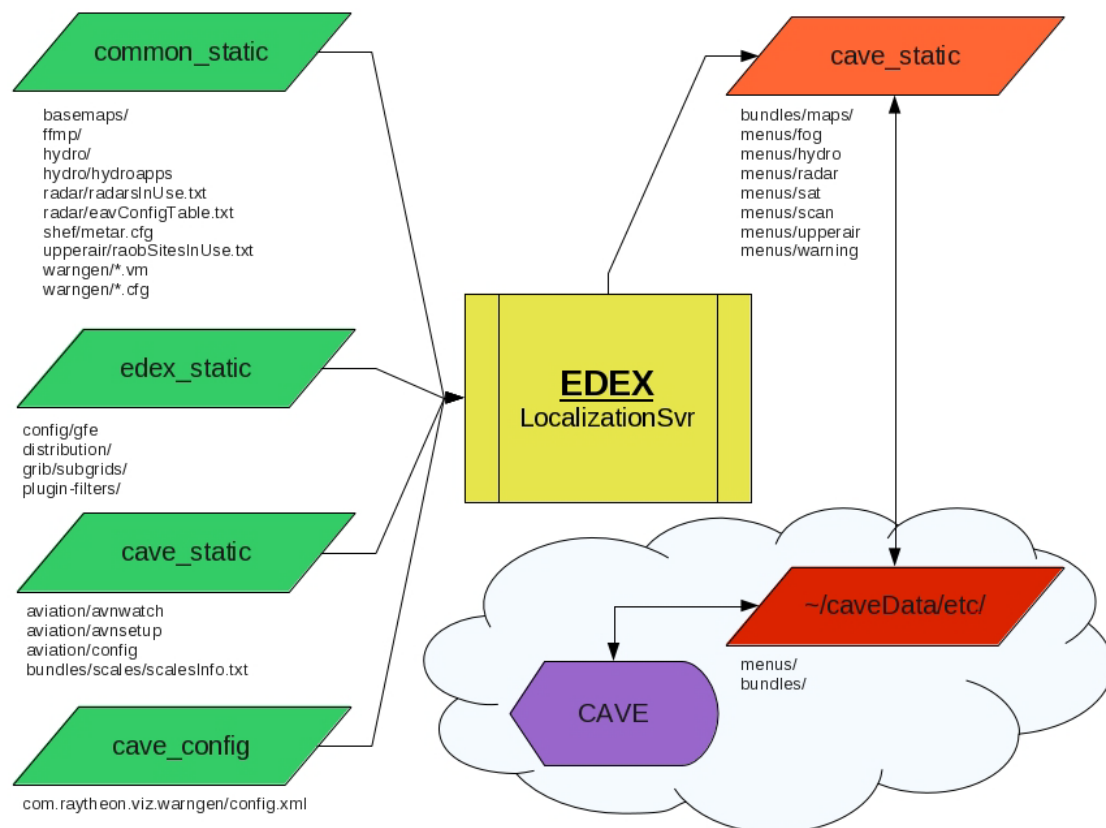

Exhibit 15-1. Localization in AWIPS II

This chapter focuses on creating the configuration files necessary for EDEX to correctly create the output files needed for proper baseline operations.

**General Note:** Never edit files that are in a base directory tree. Although there are a few exceptions as of the date of this document's creation, anything beneath a directory named base in the configuration tree should never be edited. This is analogous to the nationalData directory in AWIPS I.

## 15.1 Conventions Applied to This Chapter

### 15.1.1 General Conventions

When specific commands are being displayed to type, the following will be used as the convention. The user should type on the screen everything following the # symbol.

For example:

```
# ssh dx1
```

This indicates the user should secure shell into dx1 (*ssh dx1*).

At points in this chapter, it is necessary to reference a command that could be used for multiple iterations to achieve the same effect. The double bracket will enclose a description of what the user is to input in place of the notated reference.

For example:

```
[ [ database name ] ]
```

This indicates the user should run the command for as many iterations of database name as needed to complete the desired configuration.

When a substitution needs to be made in a command that is to be interpreted by the user, the following syntax will be used:

```
<< Site ID >>
```

This indicates that the user should interpret the correct site identifier to put into the command.

When specific paths are shown, they will be given a background shade (as in the example that follows):

```
/awips2/edex
```

### 15.1.2 Variable Conventions

Table 15.1.2-1 defines a list of variables referenced in this chapter, provides a description of each variable, and identifies the current location of each variable as of the date of this publication. Wherever a variable occurs in this chapter, the actual value should be substituted when typing the commands on an AWIPS system. *These are not environment*



*variables at this point in time, so manual substitution should be made when typing commands that contain references to these variables.*

**Table 15.1.2-1. Document Variable Conventions**

Environment Variable	Description	Default Location
\$CAVE	The hostname of a CAVE workstation.	lx1, lx2, lx3, etc....
\$DB_SERVER	The hostname of the server running the Postgres database engine.	dx1f
\$EDEX1	The primary EDEX servers.	dx3
\$EDEX_CONFIG	The location in which the configuration files on the EDEX servers reside.	/awips2/edex/data/utility
\$EDEX_DB_HOME	The location of the database files that control the functionality of the PostgreSQL engine, as well as the physical storage for the data held within the tables.	/awips2/data [DX1 and DX2]
\$EDEX_HOME	The home location for the EDEX JVM.	/awips2/edex
\$LDM_DOWNSTREAM	The hostname of the server running the downstream LDM client.	dx2f
\$LDM_HOST	The hostname of the server running the upstream/feeder LDM host.	cpsbn1/cpsbn2
\$RCM_INSTALL_DIR	The location in which the AWIPS II RadarServer is installed.	/awips2/rcm
\$RCM_SERVER	The hostname of the server running the AWIPS II RadarServer.	dx1f

**Note:** As of the date this chapter was produced, there is no plan to have these be system environment variables on an AWIPS or ADAM system. The location should be known to the user following the steps outlined here. Normally the value under the expected location is that to which an AWIPS site or ADAM platform would adhere, with the exception of the server and cave platforms. Those, for an ADAM platform only, would all be adam1.

## 15.2 Radar Localization

EDEX dynamically creates the files needed for the CAVE Radar, from specific input files in the common utility configuration directory tree.

### 15.2.1 Changing Radar Menus

During site migration, the config\_awips2.sh took information from AWIPS I input files and created a file that used by EDEX to localize the radar menus in CAVE. This file is named **radarsInUse.txt** and it resides in the following location:

**/awips2/edex/data/utility/common\_static/site/LLL/radar**

(where LLL is the AWIPS ID of your localization site)

This location is accessible on your EDEX servers (dx3, dx4 for WFOs, dx3, dx4, dx5, and dx6 for NCEP).

An example of the file follows:

```
# DO NOT EDIT LINES BEGINNING WITH '#'
# LOCAL_RADARS (including terminal) - MUST HAVE THIS LINE
kfdx
ktxl
kvnx
tokc
koun

# DIAL_RADARS - MUST HAVE THIS LINE
kinx
kddc
kict
ksrx
kfws
kdyx
klbb
kama
xcyr
xrsp
xlwe
xsao

# ASR_RADARS - MUST HAVE THIS LINE

# ARSR_RADARS - MUST HAVE THIS LINE

# MOSAIC_RADARS - MUST HAVE THIS LINE
ktxl
kvnx
kfdx
kddc
kict
kinx
kdyx
kfws
kama
```

As noted, the lines beginning with '#' are necessary, as the code uses these to parse through the file.

Table 15.2.1-1 describes the sections of the radarsInUse.txt file.

**Table 15.2.1-1. Sections of the radarsInUse.txt File**

Section Divider	Description
LOCAL_RADARS (including terminal) - MUST HAVE THIS LINE	For each radar this divider finds after this line, and before the next section divider, it creates a contribution to the CAVE menu which shows that radar on the main CAVE menu across the top of the D2D perspective.
DIAL_RADARS - MUST HAVE THIS LINE	For each radar this divider finds after this line, and before the next section divider, it creates a contribution to the CAVE menu under the Radar --> Dial Radars submenu structure. There will be a submenu for each radar.
ASR_RADARS - MUST HAVE THIS LINE	For each radar this divider finds after this line, and before the next section divider, it creates a contribution to the CAVE menu under the Radar --> ASR-11 Radar submenu structure. There will be a submenu for each radar.
ARSR_RADARS - MUST HAVE THIS LINE	For each radar this divider finds after this line, and before the next section divider, it creates a contribution to the CAVE menu under the Radar --> ARSR-4 Radar submenu structure. There will be a submenu for each radar.
MOSAIC_RADARS - MUST HAVE THIS LINE	For each radar this divider finds after this line, and before the end of the file, it will include the radar in the default mosaic when selecting a product under the ---- Mosaic ---- selections in the Radar menu of the D2D perspective in CAVE.

This file is not available via the localization perspective and must be edited from an EDEX server. This means that the maintainer must have root access in order to gain access to user awips.

To make a change to the radar menus, perform the following steps:

1. Log in to an EDEX server (dx3 or dx4 at a WFO/RFC, dx3-dx6 at NCEP) as user root.

```
ssh root@dx3
```

2. Switch to user awips.

```
su - awips
```

3. Navigate to the site-level radar directory for the CAVE localization you are attempting to affect. In the example below, it is noted as LLL. Replace LLL with the appropriate AWIPS ID when typing.

```
cd /awips2/edex/data/utility/common_static/LLL/radar
```

4. Add or remove radars to the appropriate section using Table 15.2.1-1 as a guide as to how to affect the menus.

```
vi radarsInUse.txt
```

5. Save and close the file.

```
:wq!
```

6. Launch a new CAVE.

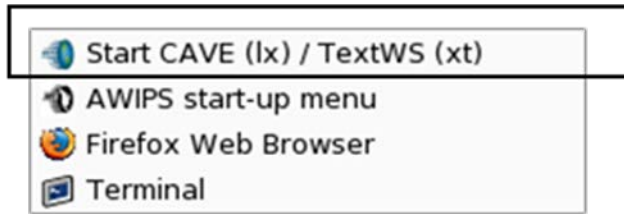

### 15.2.2 Adding or Removing an RPG (Access Configuration Files)

Configuration files that control which RPGs are usable by the active site are now in /awips2/rcm on dx1 and dx2 where the RPG Configuration Manager (RCM) JVM will run along with the a2dx1apps package. When adding data to these files, the site should make sure that the Radar Operations Center (ROC) is aware of these additions so that there is no RPG contention, especially during severe weather. When deleting from these files, please be aware that you may be completely disabling that radar from your ingest (SBN, dial, and dedicated).

See Table 15.2.2-1 for brief descriptions of the of the RPG access configuration files.

**Table 15.2.2-1. RPG Access Configuration Files**

Location	Description
/awips2/rcm/data/config/drop-ins	Directory for RPS lists, both configured and baseline rps-RPGOP* files. Also holds prodList.txt, and wmoSiteInfo.txt
/awips2/rcm/data/config/persist	Directory for configuration files that affect how RCM runs. These include ActiveMultipleRequests.xml and config.xml

#### 15.2.2.1 RCM config.xml File

The AWIPS II RCM config.xml file is the main configuration file for how the RCM process runs. Initially, it is created with the importAwips1 script, which parses the multiple AWIPS I files and creates the one config.xml for AWIPS II. There should be no need to edit this file manually. However, if there is need, a text editor (like vi) must be used. Table 15.2.2.1.1 describes portions of the config.xml for information purposes only.

**Table 15.2.2.1-1. Elements of the config.xml File**

Element	Sub-Elements	Description
<config></config>	<pupID> <regionCode> <wmoSiteID> <collectionEnabled> <tdwrCollectionLimited> <decompressProducts> <edexEndPoint> <endPointConfig> <radars>	Main configuration element in the xml file.

Element	Sub-Elements	Description
<pupID></pupID>		Valid pupID assigned by the ROC and should not be randomly assigned or changed.
<regionCode>		
<wmoSiteID>		Valid AWIPS site ID for WMO header on radar products sent via WAN for SBN uplink.
<collectionEnabled>		Master enable token that indicates whether this site is a national reporter for any configured radar and the products should be sent out over the WAN.  Also affects related behavior like adding the national RPS list to the local RPS list.
<tdwrCollectionLimited>		
<decompressProducts>		
<edexEndpoint>		This tag is no longer utilized.
<endPointConfig>	<archiveRoot> <connectionURL> <topic>	Configured end point for data delivery within the AWIPS II system architecture.
<archiveRoot>		Directory where products are written after processing from RPG. Default: /data_store/radar
<connectionURL>		Connection URL for qpidd running on the site. Should not be changed.
<topic>		QPID topic to populate once raw file is written to disk. Default: radarserver.dropbox
<radars>	<radar>	High level element which holds individual <radar> elements that configure specific connections.
<radar>	<radarID> <nexradID> <enabled> <dedicated> <collectionEnabled> <sendEnvironmentalData> <linkType> <links> <productAvailabilityFieldUsable>	Beginning of element which defines a specific RPG connection using the sub-tags defined in the previous column.
<radarID>		Four letter alpha character identifier for the radar (e.g., klwx).

Element	Sub-Elements	Description
<nexradID>		The unique nexrad ID of the radar. Assigned by the ROC.
<enabled>		Whether the link is enabled or disabled. Values are <b>true</b> or <b>false</b> .
<dedicated>		Is this a dedicated connection, or used just for OTR? Values are <b>true</b> or <b>false</b> .
<collectionEnabled>		Indicates whether products collected from this radar ID should be sent out over the WAN.  Also affects related behavior like adding the national RPS list to the local RPS list.
<sendEnvironmentalData>		Whether or not to send environmental data to the RPG.
<linkType>		Should always be TCP_WAN.
<links>	<link>	Starts a set of connections for this radar.
<link>	<dedicated> <linkAddress> <linkIndex> <linkType> <maxRpsListSize> <portPassword> <tcpPassword> <userPassword>	
<dedicated>		True or false.  Dedicated or Dial.
<linkAddress>		IP address including port for the link, e.g., 165.92.109.75:4489.
<linkIndex>		Link index for the connection, e.g., 25.
<linkType>		Should always be TCP_WAN.
<maxRpsListSize>		Maximum number of products to send in an RPS list to the radar.
<portPassword>		Password for the link.
<tcpPassword>		TCM access password for the link.
<userPassword>		Class 2 user password.
<productAvailabilityField Usable>		<b>True or False.</b>  Configures whether or not the RCM is to pay attention to the status flag sent by the RPG as to product availability.  Should always be false for non-live RPG feeds.

**Example config.xml**

```

<?xml version="1.0" encoding="UTF-8" standalone="yes"?>
<config>
  <pupID>999</pupID>
  <regionCode>3</regionCode>
  <wmoSiteID>KXXX</wmoSiteID>
  <collectionEnabled>true</collectionEnabled>
  <tdwrCollectionLimited>true</tdwrCollectionLimited>
  <decompressProducts>true</decompressProducts>
  <edexEndpoint>/awips2/edex/data/sbn/radar</edexEndpoint>
  <endpointConfig>
    <archiveRoot>/data_store/radar</archiveRoot>
    <connectionURL>amqp://guest:guest@edex?brokerlist='tcp://cplf:5672'</connectionURL>
    <topic>radarserver.dropbox</topic>
  </endpointConfig>
  <radars>
    <radar>
      <radarID>kxxx</radarID>
      <nexradID>519</nexradID>
      <enabled>true</enabled>
      <dedicated>true</dedicated>
      <collectionEnabled>true</collectionEnabled>
      <sendEnvironmentalData>true</sendEnvironmentalData>
      <linkType>TCP_WAN</linkType>
      <links>
        <link>
          <dedicated>true</dedicated>
          <linkAddress>165.92.999.99:4489</linkAddress>
          <linkIndex>25</linkIndex>
          <linkType>TCP_WAN</linkType>
          <maxRpsListSize>150</maxRpsListSize>
          <portPassword>TCPG</portPassword>
          <tcmPassword>passwd</tcmPassword>
          <userPassword>XXXWIP</userPassword>
        </link>
      </links>
    </radar>
  </radars>
</config>

```

```

<productAvailabilityFieldUsable>>false</productAvailabilityFieldUsable>
  </radar>
</radars>
</config>

```

### 15.3 WarnGen Localization

This section provides information relating to WarnGen localization activities. Like other areas of the software, WarnGen is localized by using configuration files on the EDEX server. These files affect the look and functionality of the application when run through CAVE. Exhibit 15.3-1 illustrates the Flow Chart for WarnGen.

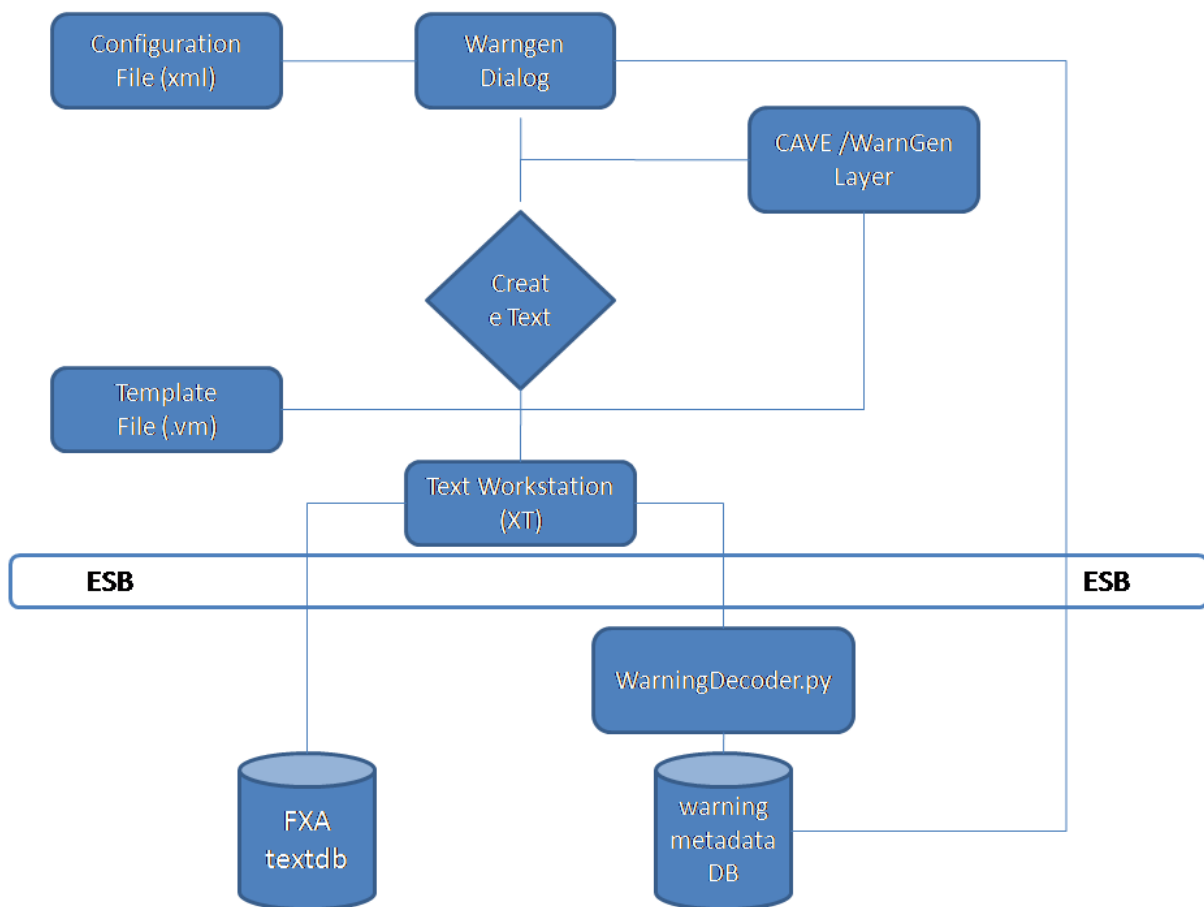

Exhibit 15.3-1. WarnGen Flow Chart

#### 15.3.1 Modifying Default WarnGen GUI Configuration

The default WarnGen configuration file was originally configured using the config\_awips2.sh wg option during site migration. It took values from the wwaConfig.txt in AWIPS I to create the entries in the AWIPS II config.xml file. It now can be modified



from the Localization Perspective within CAVE. Users who should have permission to modify this file should be granted the proper permissions in the roles.xml file, which resides in /awips2/edex/data/utility/edex\_static/site/LLL/roles

```
<role
roleId="com.raytheon.localization.site/common_static/warngen/config.xml">

    <user id="kevinj"/>

</role>
```

With this role setup, those users with permissions can open the SITE-level config.xml in the following location in the localization perspective.

### D2D → Warngen → config.xml

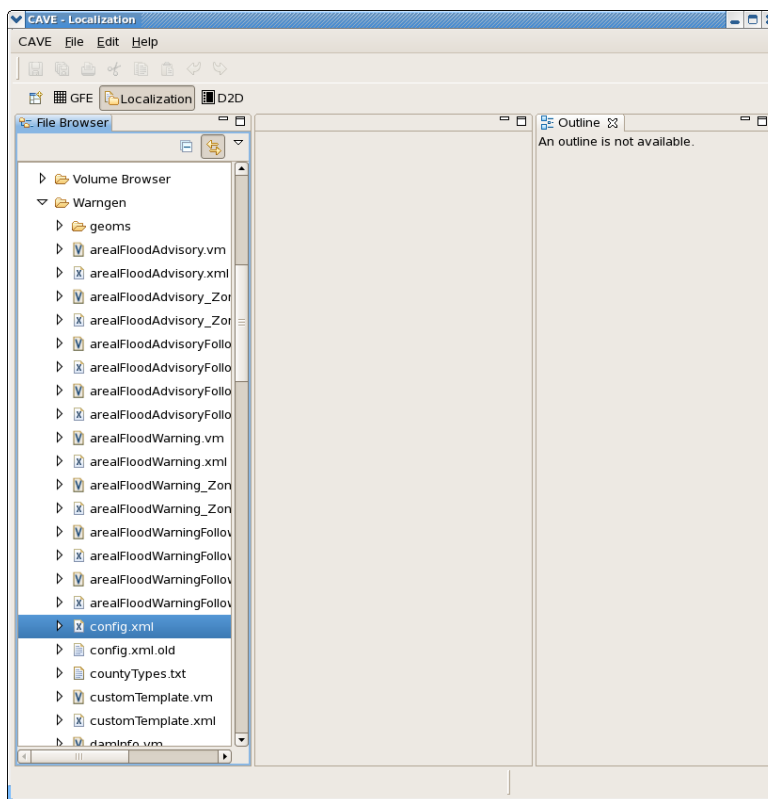

From this point, locate the file config.xml and expand it by clicking in the ►

Double click on the SITE (LLL) entry to enter the editor.

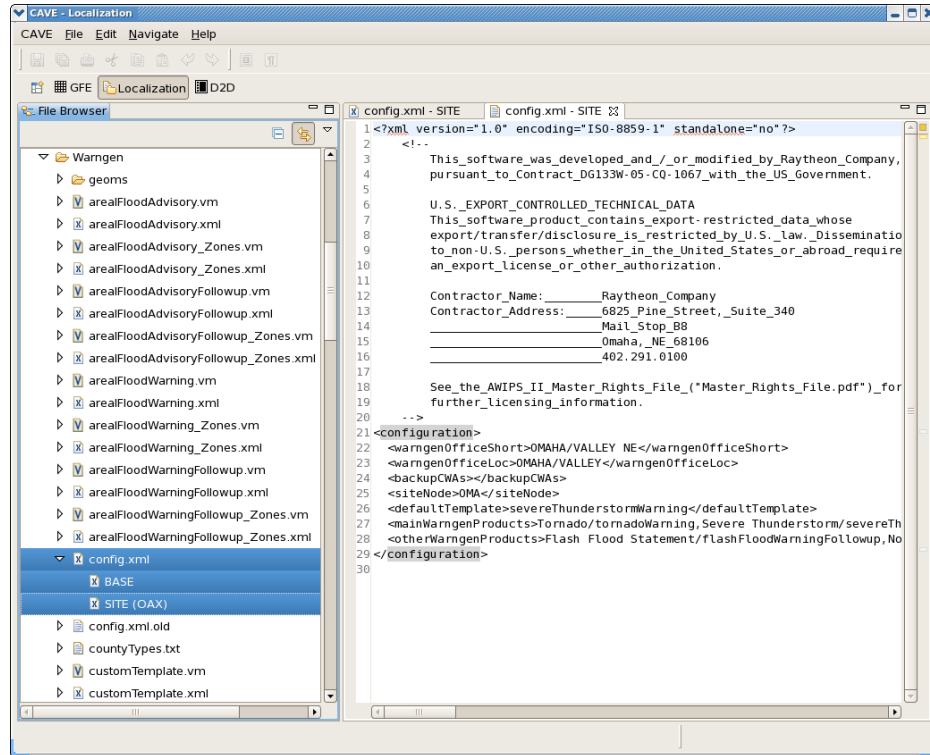

Use Table 15.3.1-1 to find the field that needs to be localized and change the value.

**Table 15.3.1-1. Localization Fields**

Element	Description
<warngenOfficeShort>	The office description included in the heading of the warning.
<warngenOfficeLoc>	The short office description included in the heading of the warning.
<backupCWAs>	A comma-separated list of sites that appear in the Backup pull-down menu in the WarnGen GUI, including a description of the site to be included in the template:  Format: XXX/DESCRIPTION  Each entry for a site must include both the XXX and the DESCRIPTION, where XXX is the AWIPS Site ID.
<sideNode>	Provides a default site node if one cannot be found in the afos2awips table within the metadata database. This field is unused if an entry is found in the table.
<defaultTemplate>	The WarnGen template identifier of the template whose radio button is selected by default when the WarnGen GUI is launched. This template must be listed in <mainWarngenProducts> tag also.
<mainWarngenProducts>	A comma-separated list of templates that appear under 'Product Type' on the WarnGen GUI and are able to be selected via radio buttons  Format: template Title/ warngen template file name
<otherWarngenProducts>	A comma-separated list of templates that appear under the Other drop-down selector in the WarnGen GUI within the 'Product Type' section.  Format: template Title/ warngen template file name

**Example File:**

```
<?xml version="1.0" encoding="ISO-8859-1" standalone="no"?>
  <!--
    This software was developed and/_or_modified_by_Raytheon_Company,
    pursuant_to_Contract_DG133W-05-CQ-1067_with_the_US_Government.

    U.S._EXPORT_CONTROLLED_TECHNICAL_DATA
    This software product contains export-restricted data whose
    export/transfer/disclosure_is_restricted_by_U.S._law._Dissemination
    to_non-U.S._persons_whether_in_the_United_States_or_abroad_requires
    an_export_license_or_other_authorization.

    Contractor_Name:_____Raytheon_Company
    Contractor_Address:_____6825_Pine_Street,_Suite_340
    _____Mail_Stop_B8
    _____Omaha,_NE_68106
    _____402.291.0100

    See_the_AWIPS_II_Master_Rights_File_("Master_Rights_File.pdf")_for
    further_licensing_information.
  -->
<configuration>
  <warnGenOfficeShort>GRAND RAPIDS MI</warnGenOfficeShort>
  <warnGenOfficeLoc>GRAND RAPIDS </warnGenOfficeLoc>
  <backupCWAs>GRR/GRAND RAPIDS,DTX/DETROIT/PONTIAC,IWX/NORTHERN
INDIA</backupCWAs>
  <siteNode>ARB</siteNode>
  <defaultTemplate>severeThunderstormWarning</defaultTemplate>
  <mainWarnGenProducts>Tornado/tornadoWarning,Severe
Thunderstorm/severeThunderstormWarning,Severe Weather
Statement/severeWeatherStatement,Significant Weather
Advisory/significantWeatherAdvisory,Flash Flood
Warning/flashFloodWarning</mainWarnGenProducts>

  <otherWarnGenProducts>Flash Flood Statement/flashFloodWarningFollowup,Non-
Convective FFW (incl. Dam Break)/nonConvectiveFlashFloodWarning,Non-Convective
Flash Flood Statement/nonConvectiveFlashFloodWarningFollowup,Areal Flood
Warning/arealFloodWarning,Areal Flood Warning
Followup/arealFloodWarningFollowup,Areal Flood
Advisory/arealFloodAdvisory,Areal Flood Advisory
Followup/arealFloodAdvisoryFollowup,Special Weather
Statement/specialWeatherStatement,Short Term
Forecast/shortTermForecast</otherWarnGenProducts>
</configuration>
```

**15.3.2 Product Templates for WarnGen**

Templates for WarnGen are housed on the EDEX servers in the following location:

```

/awips2/edex/data/utility/common_static/base/warngen
/awips2/edex/data/utility/common_static/site/warngen

```

The baseline templates should be sufficient to send properly formatted products using WarnGen. If the need arises to change, it can be modified by promoting a BASE level file to the SITE level file, and making the appropriate changes.

Users who should have permission to modify this file should be granted the proper permissions in the roles.xml file which resides in  
/awips2/edex/data/utility/edex\_static/site/LLL/roles

```

<role
roleId="com.raytheon.localization.site/common_static/warngen/config.xml">
    <user id="kevinj"/>
</role>

```

With this role setup, those users with permissions can promote BASE templates to the SITE level in the following location in the localization perspective:

### D2D → WarnGen

From this point, locate the template file and expand it by clicking in the ►. Then right click and select Copy To → SITE.

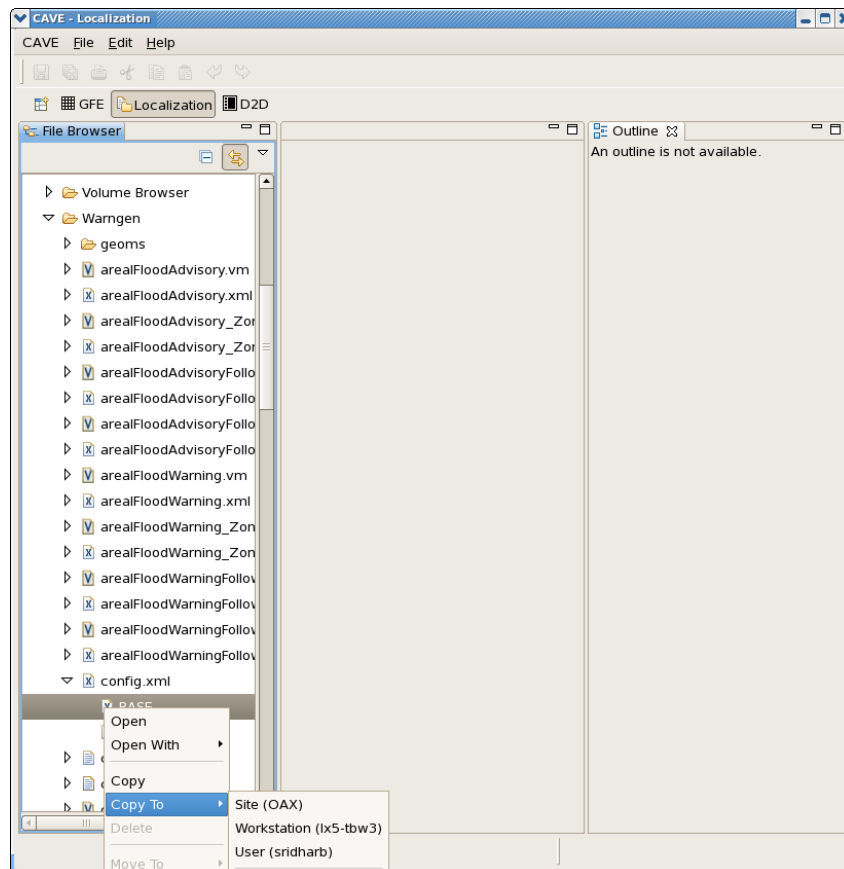

### 15.3.3 WarnGen Templates

Tables 15.3.3-1 – 15.3.3-4 provide lists of WarnGen templates for AWIPS II. Equivalents for AWIPS I are also included in the tables for reference.

**Table 15.3.3-1. WarnGen Severe Weather Product Templates**

Warning	AWIPS I	AWIPS II
Tornado Warning - PIL: TOR, e.g., STLTORREAX	wwa_tor.preWWA	tornadoWarning.vm and tornadoWarning.xml
Severe Thunderstorm Warning - PIL: SVR, e.g., STLSVREAX	wwa_svr.preWWA	severeThunderstormWarning.vm and severeThunderstormWarning.xml
Severe Weather Statement, follow-up to TOR or SVR - PIL: SVS, e.g., STLSVSEAX	wwa_svrwx_sta_county.preWWA	severeWeatherStatement.vm and severeWeatherStatement.xml
Extreme Wind Warning - PIL: EWW, e.g., MIAEWWMFL	wwa_eww.preWWA	extremeWindWarning.vm and extremeWindWarning.xml
Severe Weather Statement, follow-up to EWW - PIL: SVS, e.g., MIASVSMFL	wwa_eww_svs.preWWA	extremeWindWarningFollowup.vm and extremeWindWarningFollowup.xml

**Table 15.3.3-2. WarnGen Marine Weather Product Templates**

Warning	AWIPS I	AWIPS II
Special Marine Warning - PIL: SMW, e.g., BOSSMWBOX	wwa_specmarine.preWWA	specialMarineWarning.vm and specialMarineWarning.xml
Marine Weather Statement, follow-up to SMW - PIL: MWS, e.g., BOSMWSBOX	AWIPS I template: wwa_mar_wx_sta.preWWA	specialMarineWarningFollowup.vm and specialMarineWarningFollowup.xml
Standalone Marine Weather Statement - PIL: MWS, e.g., WBCMWSLWX	wwa_mws_nosmw.preWWA	marineWeatherStatement.vm and marineWeatherStatement.xml
Standalone Marine Weather Statement for Ashfall - PIL: MWS, e.g., ANCMWSAFC	(unknown - Alaska region)	marineWeatherStatementAshfall.vm and marineWeatherStatementAshfall.xml

**Table 15.3.3-3. WarnGen Hydrologic Product Templates**

Warning	AWIPS I	AWIPS II
Flash Flood Warning (convective) - PIL: FFW, e.g., STLFFWSGF	wwa_ffw.preWWA	flashFloodWarning.vm and flashFloodWarning.xml  ALASKA: flashFloodWarning_Zones.vm and flashFloodWarning_Zones.xml
Flash Flood Statement (follow-up to convective FFW) - PIL: FFS, e.g., STLFFSSGF	wwa_fflood_sta_county.preWWA	flashFloodWarningFollowup.vm and flashFloodWarningFollowup.xml  ALASKA: flashFloodWarningFollowup_Zones.vm and flashFloodWarningFollowup_Zones.xml

Warning	AWIPS I	AWIPS II
Non-Convective Flash Flood Warning (incl. Dam Break) - PIL: FFW, e.g., OMAFFWOAX	wwa_dam_break.preWWA	nonConvectiveFlashFloodWarning.vm and nonConvectiveFlashFloodWarning.xml  ALASKA: nonConvectiveFlashFloodWarning_Zones.vm and nonConvectiveFlashFloodWarning_Zones.xml
Non-Convective Flash Flood Statement (incl. Dam Break) - PIL: FFS, e.g., OMAFFSOAX	wwa_fflood_sta.preWWA	nonConvectiveFlashFloodWarningFollowup.vm and nonConvectiveFlashFloodWarningFollowup.xml  ALASKA: nonConvectiveFlashFloodWarningFollowup_Zones.vm and nonConvectiveFlashFloodWarningFollowup_Zones.xml
Areal Flood Warning - PIL: FLW, e.g., WBCFLWLWX	wwa_flood_wrn.preWWA	arealFloodWarning.vm and arealFloodWarning.xml  ALASKA: arealFloodWarning_Zones.vm and arealFloodWarning_Zones.xml
Areal Flood Statement (follow-up to FLW) - PIL: FLS, e.g., WBCFLSLWX	wwa_flood_sta.preWWA	arealFloodWarningFollowup.vm and arealFloodWarningFollowup.xml  ALASKA: arealFloodWarningFollowup_Zones.vm and arealFloodWarningFollowup_ZONES.xml
Areal Flood Advisory (events below severe criteria) - PIL: FLS, e.g., STLFLSSGF	wwa_flood_adv.preWWA	arealFloodAdvisory.vm and arealFloodAdvisory.xml  ALASKA: arealFloodAdvisory_Zones.vm and arealFloodAdvisory_Zones.xml
Areal Flood Advisory Statement (follow-up to areal flood advisory) - PIL: FLS, e.g., STLFLSSGF	wwa_flood_adv_sta.preWWA	arealFloodAdvisoryFollowup.vm and arealFloodAdvisoryFollowup.xml  ALASKA: arealFloodAdvisoryFollowup_Zones.vm and arealFloodAdvisoryFollowup_Zones.xml

**Table 15.3.3-4. WarnGen Non-Warning Product Templates\***

Warning	AWIPS I	AWIPS II
Significant Weather Advisory - PIL: SPS, e.g., STLSPSEAX	wwa_swa.preWWA (in /data/fxa/customFiles or /awips/fxa/data/localization/XXX)	significantWeatherAdvisory.vm and significantWeatherAdvisory.xml
Short Term Forecast - PIL: NOW, e.g., WBCNOWLWX	wwa_shorttermfcst.preWWA	shortTermForecast.vm and shortTermForecast.xml
Special Weather Statement - PIL: SPS, e.g., WBCSPSLWX	wwa_sws.preWWA	specialWeatherStatement.vm and specialWeatherStatement.xml
<i>*These are non-warning products, which can be used; however, WFOs are not mandated to use them.</i>		

### 15.3.3.1 Auxiliary WarnGen Template Files

A list of the Auxiliary WarnGen Template files follows. You will likely note additional files in the AWIPS II WarnGen directory, some of which may be edited. Others are part of the baseline.

The baseline files (found in `$EDEX_HOME/data/utility/common_static/base/warnngen`) are:

- **countyTypes.txt.** A translational table to create proper county/zone/independent city wording.
- **states.txt.** A translational table of state abbreviations.
- **immediateCauses.txt.** A translational table of hydro VTEC immediate causes.
- **VM\_global\_library.** A Velocity template repository houses functions that are used repeatedly through the WarnGen templates. If you find a `#functionname(args)` like syntax and cannot figure out what it does, chances are that the referenced function is contained here.

The editable files (found in `$EDEX_HOME/data/utility/common_static/site/XXX/warnngen`) are:

- **dupCounties.vm.** An import file to assist those sites that have same-named counties across two states. Similar to a patch placed in AWIPS I to produce correct text output.
- **damInfo.vm.** Created to assist users in creating local dam information for the non-convective Flash Flood Warning/Statement?.
- **damInfoBullet.xml.** Same as `damInfo.vm`, except that it is used to create bullets that are displayed in the WarnGen GUI through the accompanying non-convective Flash Flood Warning/Statement? XML files.
- **damInfoBulletName.xml.** Same as `damInfoBullet.xml`, but used to create bullets that are displayed in the WarnGen GUI through the accompanying non-convective Flash Flood Warning/Statement? XML files.
- **mileMarkers.xml.** An XML file that creates WarnGen objects from the mile markers tables in the AWIPS II database. The WarnGen documentation describes the utilization of the `importMarkersInfo.sh` script to get AWIPS I mile markers into AWIPS II. This XML file contains instructions and an example for making the mile marker information available for use in the templates. This XML file is referenced via an "include" statement in each WarnGen template's XML configuration file. Simply uncomment the include section that has already been inserted by the developers.
- **mileMarkers.vm.** The "guts" that actually generate the mile marker or road output. Here you will reference the mile marker objects created in the XML file, and create "lead-ins" that will create proper phrasing for your mile marker output. This auxiliary vm file is then referenced via a "parse" statement in each WarnGen template's Velocity .vm file, instructing WarnGen to generate the mile marker output. Simply

uncomment the appropriate section in each WarnGen template's vm file that has already been inserted by the developers.

- **forecasterName.vm.** vm code that will help assign a warning forecaster name to warnings automatically. Must be customized to create local user's desired moniker (name, initials, number, etc.). This auxiliary vm file is then referenced (if desired) via a "parse" statement added to each WarnGen template's Velocity .vm file.

### 15.3.4 Configuration

#### 15.3.4.1 Configuration Files (.xml)

Each warning Velocity template has a complementary configuration file (.xml). This configuration will set different variables that can dynamically change how WarnGen acts depending on the warning type. It is important to note that each configuration must start and end with a <warnGenConfig> and </warnGenConfig> tag. Also, comments can be maintained with <!--comment> .

#### *How to configure warnings to be county, zone, or marine zone based*

Each warning references an area source or table in the database: County; Zone; or MarineZones. Table 15.3.4.1-1 shows what values to set for the fields in order to configure a warning to the correct area source properly. The ugcline referenced in the .vm files will automatically be in the correct format (county or zone).

**Table 15.3.4.1-1. Field Values**

	areaConfig areaField	areaConfig fipsField	pathcastConfig areaField	geospatialConfig areaSource	geospatialConfig pointSource
County	COUNTYNAME	FIPS	COUNTYNAME	COUNTY	CITY
Zone	NAME	STATE_ZONE	NAME	ZONE	CITY
Marine Zones	NAME	ID	NAME	MARINEZONES	MARINESITES

- **Units: <unitDistance> & <unitSpeed>.** Unit distance is the unit the distance result will be in and unit speed is the unit the speed result will be in.
  - <unitDistance>mi</unitDistance>
  - <unitSpeed>mph</unitSpeed>
- **Maps: <maps>.** Maps contained within <map></map> will get loaded with this template. Refer to 'Maps' menu in CAVE. The various menu items are also the different maps that can be loaded with each template.
- **Followups: <followups>.** Each associated follow-up should be contained within <followup></followup>. Each follow-up will become available when the appropriate time range permits.
- **Phen Sigs: <phensigs>.** Each associated phen sig should be contained within <phensig></phensig>.



- **Enable Restart:** `<enableRestart>`. Enables/disables user from selecting the Restart button on the GUI. This is usually set to false for follow up configuration files. Because this variable is usually set to false for follow-ups, this also controls if the 'Drag me to storm' text will become available.
- **Enable Dam Break Threat:** `<enableDamBreakThreat>`. Enables/disables the 'Dam Break Threat Area' button. This is mainly used for dam break templates.
- **Auto Lock Text:** `<autoLockText>`. Enables/disables the system to lock text based on various patterns. Refer to Locking Text section for more information.
- **Watches:** `<includedWatches>`. Each watch to be included should be contained within `<includedWatch></includedWatch>`. The only two possible values are 'torWatches' and 'svrWatches'. Refer to includeWatchAreaBuffer in the Area Configuration for more information.
- **Duration:** `< durations >`. Each available duration should be contained with `<duration></duration>`. The default duration should be contained with `<defaultDuration></defaultDuration>`. However, default duration should not be included within `< durations >`.
- **Locked Groups on Followup:** `<lockedGroupsOnFollowup>`. On a follow-up, there are certain groups that cannot be unselected, such as a dam or ic. However, there may be another group defined by the user that he or she would want to have locked down, such as advType. The following is an example:
 

```
<lockedGroupsOnFollowup>dam,ic</lockedGroupsOnFollowup>
```
- **Bullet Action Groups:** `<bulletActionGroups>`. The bullet action groups maintain all `bulletActionGroups` and should be contained with `<bulletActionGroups></bulletActionGroups>`. Within the `bulletActionGroup` is a `<bulletActionGroup></bulletActionGroup>` that contains all the available bullets for the associated action, phen, and sig.

Example:

```
<bulletActionGroups>
  <bulletActionGroup action="NEW" phen="TO" sig="W">
    <bullets>
      <!-- List of bullets for a NEW, Tornado Warning -->
    </bullets>
  </bulletActionGroup>
  <bulletActionGroup action="COR" phen="TO" sig="W">
    <bullets>
      <!-- List of bullets for a COR, Tornado Warning -->
    </bullets>
  </bulletActionGroup>
</bulletActionGroups>
```

- **Bullets:** `<bullets>`. The bullets populate the selection list in the WarnGen dialog. Each bullet should be contained in a `<bullet>` tag. The following are the different parameters available to a bullet:

- **bulletName:** An id that is passed to the template when a bullet is selected. This name should be unique as it can be used as an identifier with the velocity files. However, 'siteimminent' and 'sitefailed' are reserved bullet names for dam breaks.
- **bulletText:** The text presented to the user in the selection list.
- **bulletGroup:** only one bullet can be selected per bulletGroup.
- **bulletType:** 'Title' is unselectable.
- **showString:** If the string MATCHES a phrase in the follow-up, then the bullet will be available; if this value is not set, then the bullet will automatically be available.
- **parseString:** If this string MATCHES a phrase in the follow-up warning, then the associated bullet will be automatically be highlighted in the selection list for a follow-up.

If there are multiple strings that need to be tested, the escape character '&quot;' needs to be placed before and after the phrase to be matched. For example, `parseString="&quot;LINE OF SEVERE THUNDERSTORMS&quot;,&quot;SQUALL&quot;"`. If the warning text contains "LINE OF SEVERE THUNDERSTORMS" and "SQUALL", then the associated bullet will be highlighted.

Furthermore, if a phrase begins with '-' and is not in the warning text, then the associated bullet will always be highlighted. For example, `parseString="&quot;-SQUALL&quot;"`

- **loadMap:** Refer to 'Maps' menu in CAVE. The various menu items are also the different maps that can be loaded with each template.
  - **floodSeverity:** Used to highlight the correct severity on a correction.
- **Dam Info Bullets: <damInfoBullets>.** The bullets populate the selection list in the WarnGen dialog. Each bullet should be contained in a <damInfoBullet> tag. The following are the different parameters available to a bullet:
    - **bulletName:** An id that is passed to the template when a bullet is selected. This name should be unique as it can be used as an identifier with the velocity files.
    - **bulletText:** The text presented to the user in the selection list.
    - **bulletGroup:** Should use either 'dam','ic', 'scenario'. Using 'dam' or 'ic' will lock the bullet on a follow-up.
    - **bulletType:** 'Title' is unselectable.
    - **coords:** The lat/lon coordinates in the format usually found at the bottom of the warnings (i.e., LAT...LON 3981 7868 3980 7861 3972 7862 3972 7874).

Example:

```
<damInfoBullets>
  <damInfoBullet bulletName="branchedOakDam" bulletText="Branched Oak dam
(Lancaster county)" bulletGroup="dam" parseString="BRANCHED OAK DAM"
coords="LAT...LON 4096 9686 4094 9680 4089 9679 4089 9681 4087 9681 4086 9679
4081 9678 4082 9674 4077 9672 4082 9671 4084 9668 4085 9670 4084 9676 4093 9676
4100 9679 4096 9679 4098 9685"/>
```

```

<damInfoBullet bulletName="branchedOakDamhighfast" bulletText=" Branched Oak
high fast" bulletGroup="scenario" parseString="THE WATER DEPTH AT RAYMOND
COULD EXCEED 19 FEET IN 32 MINUTES." />
<damInfoBullet bulletName="branchedOakDamhighnormal" bulletText=" Branched
Oak high normal" bulletGroup="scenario" parseString="THE WATER DEPTH AT
RAYMOND COULD EXCEED 26 FEET IN 56 MINUTES." />
<damInfoBullet bulletName="branchedOakDammedfast" bulletText=" Branched Oak
medium fast" bulletGroup="scenario" parseString="THE WATER DEPTH AT
RAYMOND COULD EXCEED 14 FEET IN 33 MINUTES." />
<damInfoBullet bulletName="branchedOakDammednormal" bulletText=" Branched
Oak medium normal" bulletGroup="scenario" parseString="THE WATER DEPTH AT
RAYMOND COULD EXCEED 20 FEET IN 60 MINUTES." />
<damInfoBullet bulletName="pawneeDam" bulletText="Pawnee dam (Lancaster
county)" bulletGroup="dam" parseString="PAWNEE DAM" coords="LAT...LON 4081
9679 4081 9676 4081 9674 4084 9670 4084 9669 4081 9672 4080 9671 4077 9671 4077
9673 4079 9674 4079 9680 4082 9685 4081 9687 4082 9687 4083 9688 4085 9685"/>
<damInfoBullet bulletName="pawneeDamhighfast" bulletText=" Pawnee Dam high
fast" bulletGroup="scenario" parseString="THE WATER DEPTH AT EMERALD
COULD EXCEED 18 FEET IN 16 MINUTES"/>
<damInfoBullet bulletName="pawneeDamhighnormal" bulletText=" Pawnee Dam
high normal" bulletGroup="scenario" parseString="THE WATER DEPTH AT
EMERALD COULD EXCEED 23 FEET IN 31 MINUTES." />
<damInfoBullet bulletName="pawneeDammedfast" bulletText=" Pawnee Dam
medium fast" bulletGroup="scenario" parseString="THE WATER DEPTH AT
EMERALD COULD EXCEED 4 FEET IN 19 MINUTES." />
<damInfoBullet bulletName="pawneeDammednormal" bulletText=" Pawnee Dam
medium normal" bulletGroup="scenario" parseString="THE WATER DEPTH AT
EMERALD COULD EXCEED 17 FEET IN 32 MINUTES." />
</damInfoBullets>

```

For a further example, reference </site/OAX/warnngen/dambreak.vm>.

- **Include:** `<include file="filename.txt"/>`. Allows an external file to be inserted in the configuration file. This functionality is useful when a user wants to list dam info bullets in a separate file. The format of the include tag is `<include file="filename.txt"/>` where filename is the name of the file including the extension of the file (i.e. .txt). The file to be included should follow the rules of localization: user, site, then base.

**Note:** In order to comment out the include statement, it must be commented out in the following manner `<!-- include file="filename.txt"/> -->`

- **Area Configuration:** `<areaConfig>`. Specifies how the area portion of the warning is generated. This configuration is mainly used for determining the impacted counties in the 1<sup>st</sup> bullet. The following are the different parameters available to the areaConfig:
  - **inclusionPercent:** If an area greater than this percentage of area is covered, include it in the warning.

- ***inclusionAndOr***: AND – both inclusionPercent and inclusionArea must pass in order to be included. OR – either inclusionPercent or inclusionArea can pass to be included.
- ***inclusionArea***: If an area greater than this is covered, include it in the warning (square kilometers).
- ***areaField***: The column name of the areaSource that contains the name of the area (i.e. COUNTYNAME, NAME).
- ***parentAreaField***: The column name of the parentSource that contains the name of the parent (i.e., NAME).
- ***areaNotationField***: The column in the areaSource that contains the key used to map to the correct area notation. Look at countTypes.txt.
- ***areaNotationTranslationFile***: Translation file to look up an area notation. File located in /edex/data/utility/common\_static/base/warngen.
- ***fipsField***: The name of the attribute that retrieves the fips.
- ***pointField***: The column name in the pointSource that contains the name of the point.
- ***sortBy***: Can sort by 'name', 'parent', 'size', partOfArea, partOfParent, areaNotation, fips.
- ***pointFilter***: Controls which point to include based on the WARNGENLEV of the point. WARNGENLEV is a value from 1 to 3 where 1 is the highest priority.
  - Key WARNGENLEV (column name in the pointSource).
  - constraintValue 1, 2, and/or 3.
  - constraintType: EQUALS, IN, LIKE, NOT EQUALS, etc.
- ***includeWatchAreaBuffer***: The number of MILES the warning polygon will be increased to include nearby watches.

Example:

```

<areaConfig>
  <inclusionPercent>0.00</inclusionPercent>
  <inclusionAndOr>AND</inclusionAndOr>
  <inclusionArea>10</inclusionArea>
  <areaField>COUNTYNAME</areaField>
  <parentAreaField>NAME</parentAreaField>
  <areaNotationField>STATE</areaNotationField>
  <areaNotationTranslationFile>countyTypes.txt</areaNotationTranslationFile>
  <fipsField>FIPS</fipsField>
  <pointField>NAME</pointField>
  <sortBy>
    <sort>name</sort>
  </sortBy>
  <pointFilter>
    <mapping key="WARNGENLEV">
      <constraint constraintValue="1"
        constraintType="EQUALS" />
    </mapping>
  </pointFilter>
</areaConfig>

```

```

    </mapping>
  </pointFilter>
  <includedWatchAreaBuffer>25</includedWatchAreaBuffer>
</areaConfig>

```

- **Point Source Configuration: <pointSource>.** This configuration allows various point source results to be generated. The following are the different parameters:
  - **variable:** The name of point source results to be referenced in the .vm.
  - **searchMode:** TRACK – search for points along the entire track.. POINTS – search for every center point.
  - **withinPolygon:** If true, only return points that are within the warning polygon; otherwise, false will allow points within or beyond the warning polygon.
  - **pointField:** The field out of the pointSource that is used for naming the point.
  - **pointFilter:** Controls which point to include based on the WARNGENLEV of the point. WARNGENLEV is a value from 1 to 3 where 1 is the highest priority:
    - key WARNGENLEV (column name in the pointSource)
    - constraintValue 1, 2, and/or 3
    - constraintType: EQUALS, IN, LIKE, NOT EQUALS, etc.
  - **distanceThreshold:** The allowable distance to allow a point to be included from the track or event center.
  - **maxResults:** The max points allowed to be returned.
  - **sortBy:** Can sort by 'distance', 'name', 'warngenlev', 'population', 'lat', 'lon', 'area', 'parentArea'.

Example:

```

<pointSource variable="closestPoints">
  <pointField>NAME</pointField>
  <searchMethod>POINTS</searchMethod>
  <filter>
    <mapping key="WARNGENLEV">
      <constraint constraintValue="1,2" constraintType="IN" />
    </mapping>
  </filter>
  <maxResults>1</maxResults>
  <distanceThreshold>50</distanceThreshold>
  <sortBy>
    <sort>distance</sort>
    <sort>warngenlev</sort>
  </sortBy>
</pointSource>

```

- **Path cast Configuration: <pathcastConfig>.** This configuration indicates a track product is generated to determine the areas the storm will pass under. This is mainly for the fourth bullet and used if type 1 is selected. Refer to the macros contained in the VM\_global\_library.vm. The following are the different parameters:

- ***withinPolygon***: If true, only return points that are within the warning polygon; otherwise, false will allow points within or beyond the warning polygon.
- ***defaultDirection***: Default direction (0 degrees is South) to generate the storm track if a recent track was not issued or if there is not STI data
- ***nearThreshold***: Specifies a distance in miles that indicates how close a storm can be to a location to be included in the path cast.
- ***interval***: The interval to round the time of each path cast to.
- ***maxCount***: The max number of points to include in each path cast.
- ***delta***: Offsets for the first pathcast entry.
- ***maxGroup***: The max number of time groups to use in the pathcast.
- ***pointFilter***: Controls which point to include based on the WARNGENLEV of the point. WARNGENLEV is a value from 1 to 3 where 1 is the highest priority:
  - Key WARNGENLEV (column name in the pointSource)
  - Value 1, 2, or 3 (can only be a single value), 0 does nothing
  - Type: INCLUSIVE – include only points that match the value  
EXCLUSIVE-exclude only points that match the value

For example, INCLUSIVE 1, will only include points that are WARNGENLEV 1, EXCLUSIVE 3, will only include points that are WARNGENLEV 1 and 2.
- ***areaField***: The column name in the areaSource table that contains the name of the area.
- ***parentAreaField***: The column name in the areaSource that contains the parent of the area (i.e., State).
- ***areaNotationField***: The column name in the areaSource that contains the key used to map to the correct areaNotation. Look at countyTypes.txt.
- ***areaNotationTranslationFile***: Translation file to look up an area notation. File located in /edex/data/utility/common\_static/base/warngen.
- ***sortBy***: Can sort EACH path cast by 'distance', 'name', 'warnngenlev', 'population', 'lat', 'lon', 'area', 'parentArea'.

Example:

```

<pathcastConfig>
  <withinPolygon>true</withinPolygon>
  <defaultDirection>45</defaultDirection>
  <nearThreshold>8.0</nearThreshold>
  <interval>5</interval>
  <delta>5</delta>
  <maxCount>4</maxCount>
  <maxGroup>8</maxGroup>
  <pointField>Name</pointField>
  <pointFilter>
    <key>WARNGENLEV</key>
    <value>0</value>
  </pointFilter>
</pathcastConfig>

```

```

        <type>EXCLUSIVE</type>
    </pointFilter>
    <areaField>COUNTYNAME</areaField>
    <parentAreaField>STATE</parentAreaField>
    <areaNotationField>STATE</areaNotationField>
    <areaNotationTranslationFile>countyTypes.txt</areaNotationTranslationFile>
    <sortBy>
        <sort>distance</sort>
    </sortBy>
</pathcastConfig>

```

- **Geospatial Configuration: <geospatialConfig>**. This configuration maintains global variables (i.e., pointSource, areaSource, parentAreaSource) used by area configuration, closest points configuration, and path cast configuration. This configuration also initializes WarnGen to gather all the areas within the CWA. The following are the different parameters:
  - **pointSource**: The name of the table that reads the points from (i.e., City, MarineSites).
  - **areaSource**: The name of the table that reads the areas from (i.e., County, MarineZones).
  - **parentAreaSource**: The name of the table that reads the parent areas from (i.e., States).
  - **timezoneSource**: The name of the time zone table (i.e., TIMEZONES).
  - **timezoneField**: The name of the column in the timezoneSource that contains the time zones.

Example:

```

<geospatialConfig>
    <pointSource>City</pointSource>
    <areaSource>County</areaSource>
    <parentAreaSource>States</parentAreaSource>
    <timezoneSource>TIMEZONES</timezoneSource>
    <timezoneField>TIME_ZONE</timezoneField>
</geospatialConfig>

```

- **River Basin Configuration: <riverBasinConfig>**. This configuration uses the same format as the point source configuration and uses the variable “riverdrainages” and derives the points from the ffmp\_basins table.

Example:

```

<pointSource variable="riverdrainages">
    <pointSource>ffmp_basins</pointSource>
    <pointField>streamname</pointField>
    <filter>
        <mapping key="cwa">
            <constraint constraintValue="$warngenCWAFilter"

```

```

        constraintType="EQUALS" />
    </mapping>
</filter>
<withinPolygon>true</withinPolygon>
</pointSource>

```

#### 15.3.4.1.1 Velocity Templates

WarnGen passes various Java objects to the velocity templates that can contain various pieces of information or be a utility object which can be used in generating a warning. Some Java objects have their API available on the Internet, which can provide more information on the available methods the objects provide. It is important to understand that some objects derive information for tables that are set in the associated configuration file.

- **Header.** It is very important that the first two lines of your template contain the WMO Header and the PIL information as this information will be parsed by the text workstation and placed in the header block of a text editor.

```

${WMOId} ${vtecOffice} 000000 ${BBBId}
TOR${siteId}

```

- **VM\_global\_library.vm.** VM\_global\_library.vm contains various macros that can be referenced by all templates. Each macro performs common functions that can be used in calculating and generating text. The function name is referenced by the first parameter of the macro while the following parameters are the required parameters. For example, the macro#macro(direction \$d) is called by direction(90). The appropriate macro will be recognized and produce the appropriate text based on the parameters. However, a user can create a site level version of the VM\_global\_library.vm See #parse macro for further uses.
- **#parse.** The #parse macro is function Velocity supported function that can be used to import a file into a .vm file. The important thing to note is that if a site level .vm file implements the #parse macro, then the imported file and a site-level version of VM\_global\_library must be present in the same site level directory.
- **Variables action.** The action the warning is performing: NEW, COR, EXT, CON, CAN, and EXP. CANCON is an action indicating there were canceled areas and continued areas. This action is mainly used to help rendering both.
  - **areaPoly:** An array of Coordinates of the warning polygon.
  - **areas:** An array of AffectedAreas object. This object is usually used in the 1<sup>st</sup> bullet. An AffectedAreas object has the following members:
    - name: The name of the area affected. Refer to areaConfig.areaField
    - partOfArea: NORTH, NORTHEAST, EAST, etc.
    - areaNotation: The notation of the area affected (COUNTY, PARISH, etc.). Refer to countyTypes.txt
    - partOfParentRegion: NORTH, NORTHEAST, EAST, etc.



- **parentRegion:** The name of the parent region that is affected. Refer to `areaConfig.parentAreaSource`
- **fips.** fips county number
- **stateabbr.** State abbreviation (i.e., NE for Nebraska)
- **points.** If applicable, a list of the points that are affected
- **timezone**
- **size.** Size of the area.
- **areaSource:** The area source set in the geospatial config.
- **backupSite:** The backup site selected in the 'Backup' selection area.
- **BBBId:** A String that keeps track of the number of corrections performed on a warning (i.e., CCA).
- **bullets:** An array of Strings that contain all the bullets that were selected.
- **cancelareas:** An ArrayList of AffectedAreas objects that are canceled from the original warning. This is commonly used in follow up velocity files.
- **closestPoints:** An array of ClosestPoint objects closest to the event. A ClosestPoint object has the following members:
  - **Name:** Name of the point, such as the city name or marine site name
  - **Area:** The name of the area, such as the county name
  - **parentArea:** The name of the parent area, such as the state
  - **Point.** Coordinate of the point
  - **Distance:** Distance from point to the event
  - **roundedDistance:** Distance as a rounded integer without any decimals
  - **Azimuth:** The angle of point from the event. In other words, the point is relative to the event. Because the event is the reference, the azimuth needs 180 subtracted in order for the city to become the reference for the event.
  - **roundedAzimuth.** Azimuth to the closest 45 degree intervals
  - **oppositeAzimuth.** 180 degrees from the azimuth
  - **oppositeRoundedAzimuth.** 180 degrees from the roundedAzimuth
  - **population.** Population in the city (this variable is not available for marine sites or locally added cities or markers)
  - **Warngenlev.** Priority level where 1 is the highest.
- **dateUtil:** A DateUtil object can format a Date object (i.e., start) into a particular display string based on the passed timeFormat. Refer to timeFormat to see the all the possible types. The most useful method to use is format (date, timeFormat, interval, timezone).
- **etn:** Event Tracking Number.
- **event:** Date object of the time of occurrence of the warning/last frame.
- **eventLocation:** The Coordinate of the event. This is commonly used in the 3<sup>rd</sup> bullet.
- **expire:** Date object of the expire time of the warning.

- ***floodseverity***: This is usually used in follow up hydro products. The value is derived from the HTEC of the initial warning. The flood severity is set in the velocity template using conditional logic based on the bullets selected in the dialog. Minor flood = 1, moderate flood = 2, major flood = 3.
- ***floodic***: The immediate cause from the initial warning. This is commonly used in follow-ups.
- ***ic***: The immediate cause used in the HTEC. Common values are ER, DR, GO, IJ, RS, SM, DM.
- ***includedWatches***: An array of the included watches mentioned in the config.
- ***list – ListTool object***: Refer to API for org.apache.velocity.tools.generic.ListTool for more information.
- ***localtimezone***: Time zone derived when calculating the areas. Commonly used when using the secondBullet macro. This is a required field. Refer to the secondBullet macro for more info.
- ***mathUtil***: A WarnGen Math Tool object that extends MathTools (org.apache.velocity.tools.generic.MathTool) is used for rounding to the nearest 5 or 10, for example, of a specific value. For instance, wind speeds in the third bullet should be rounded to the nearest 5 MPH so they should call this method with the arguments (windSpeed, 5). There are two available methods for this object aside from the methods in MathTools:
  - roundToInt(value, multiple)
  - roundTo5(value): Calls roundToInt(value,5).
- ***movementDirection***: The direction of the storm track in degrees where 0 is South.
- ***movementDirectionRounded***: The rounded direction of the storm track in degree where 0 is south. The possible values are 0, 90, 135, 180, 225, 270, 315. This variable is commonly used with the macro direction to give a general description if the storm is moving NORTH, NORTHEAST, WEST, etc.
- ***movementInKts***: The movement speed in Knots. This is mainly used when generating the TML line of the warning.
- ***movementSpeed***: The speed of the storm based on the track. The speed units can be defined in the closestPointsConfig.unitSpeed configuration.
- ***now***: Date object of the current time.
- ***officeShort***: The office short name 'warngenOfficeShort' set in config.xml. Refer to Config.xml section for more information.
- ***officeLoc***: The office location name 'warngenLocation' set in config.xml. Refer to Config.xml section for more information.
- ***otherPoints***: An array of ClosestPoint objects. This array is used when type 2 or 3 is passed to the fourth Bullet. Refer to areaConfig.otherPoints to sort the array. A ClosestPoint object has the following members: name, population, warngenlev, distance.
- ***Pathcast***: An array of PathCast objects. Each PathCast object is grouped by 'time' in ascending order. This array is only used when type 1 is passed to fourthBullet. The following are members:

- Points – all the points (i.e. Cities) that are listed for the path cast in the form of an array of ClosestPoint objects.
  - Area – refer to pathCastConfig.areaField
  - areaNotation – can be either COUNTY, PARISH, ZONE. Refer to countyTypes.txt
  - parentArea – refer to pathCastConfig.parentAreaField
  - timeZone
  - Time – time of the path cast
- **phenomena:** Two-letter phenomena of the warningasd
  - **pointComparator:** Allows two closest point array objects to be combined and sorted. The key method to use is to combine. The first two parameters are the two closest point object arrays to be combined. The following parameters can be an N number of Strings that the newly combined array will be sorted by ('distance', 'name', 'warngenlev', 'population', 'lat', 'lon', 'area', 'parentArea'). For example, `pointComparator.combine(${otherPoints},${i80mm},”warngenlev”)`.
  - **productClass:** The single letter indicating if the warning in operational mode (O) or test mode (T).
  - **riverdrainages:** An array of the names of the basins that are included in the warning polygon. Refer to River Basin Configuration for more info.
  - **secondtimezone:** Time zone derived when calculating the path cast. Commonly used when using the secondBullet macro. This will only become available if the warning area crosses an additional timezone.
  - **siteId:** The 3-letter site Id used for creating the PIL. Refer to the 'Header' section for more information.
  - **specialCorText:** The raw message of the record to be corrected without the WMO header line and the PIL line. The VTEC in the raw message is updated to have a COR action. This variable is made available if there is no change in the storm track.
  - **start:** Date object of the start time of the warning.
  - **stationary:** True or false if there are no time points (i.e., only a single frame).
  - **stormType:** Used to indicate if the warning is for a single storm or a line of storms. If the value is “line” then it is a line of storms or “single” if it is a single storm.
  - **timeFormat:** Used along with the dateUtil object. The following are all the possible variables. Refer to the Java API SimpleDateFormat for more information:
    - Header: `hmm a z EEE MM d yyyy`
    - Plain: `hmm a z EEEE`
    - Clock: `hmm a z EEEE`
    - `ymdthmz: yyMMdd'T'HHmm'Z'`
    - `ddhhmm: ddHHmm`
    - Time: `HHmm`

- **ugcline:** A list of the county or zones of each affected area. This variable depends on the affected areas (i.e. county, zone, or marine zones).
- **ugclinecan:** A list of the ug or zones of each county or zone that was canceled.
- **user:** Username.
- **vtecOffice:** The 4-letter CWA that generated the warning (i.e. “KOAX”); Usually, used in the VTEC.
- **watches:** A WatchUtil object that can gather tornado and/or severe thunderstorm watches within the watch area. The areaConfig.includedWatchAreaBuffer is used to determine whether to include the watch or not. The WatchUtil has two useful methods getTorWatches and getSvrWatches. These methods return an array list of WeatherAdvisoryWatch objects that have the available variables: phensig, endTime, parentRegion, partOfParentRegion. It is important to note that the endTime is set to the latest time in the array list.
- **WMOId:** WarnGen automatically sets this variable to TTAaii. When the text is sent to text workstation, text workstation replaces it with the appropriate WMO header retrieved from the afos\_to\_awips table.

#### 15.4 Other Menu Localizations

Other menus are localized in the same manner as the radar menus listed in section 15.2. Here are some details on how some other menus are localized from the baseline.

##### 15.4.1 Upper Air Menus

During site migration, the config\_awips2.sh tool created the input file used by EDEX to create the SITE level Upper Air Menu file. The file that controls this menu creation is named **raobSitesInUse.txt** and it resides in the following location:

**/awips2/edex/data/utility/common\_static/site/LLL/upperair**  
(Where LLL is the AWIPS ID of your localized site)

This location is accessible on your EDEX servers (dx3, dx4 for WFOs, dx3, dx4, dx5 and dx6 for NCEP). An example of the file follows.

```
# DO NOT EDIT LINES BEGINNING WITH '#'
# FULLY DEFINES ALL SITES USED FOR THE LOCALIZED UPPER AIR MENU
IN CAVE
# Format is as follows:
# icao city name, state
# KXXX SiteID Anywhere, US

# UPPER_AIR menu
KOAX 72558 Omaha, NE

# LOCAL_UPPER_AIR submenu
KABR 72659 Aberdeen, SD
KBIS 72764 Bismark, ND
```

```

KLBF 72562 North Platte, NE
KMPX 72649 Minneapolis, MN
KOAX 72558 Omaha, NE
KUNR 72662 Rapid City, SD
KTOP 72456 Topeka, KS

```

The file is initially created in a fashion that is similar to the way the AWIPS I raobLocalMenus.txt is created. It finds the raobMenus.txt file, which is a baseline nationalData file, and reads in every line. It determines, based on the site for which localization is being configured, how far away from the site the RAOB is located by using the common\_obs\_spatial database table in the metadata database. If the RAOB is within 200km of the site, it adds it under UPPER\_AIR menu as seen in the example. If it is within 200km – 600km of the site, then it adds it into LOCAL\_UPPER\_AIR submenu (as also seen in the example).

When EDEX is started, it reads this file. If it has not created its output files, or the file raobSitesInUse.txt has been modified more recently than the output files have been modified or created, it will create its output files in

**/awips2/edex/data/utility/cave\_static/configured/LLL/menus/upperair**

These files are eligible for override by promoting them to the SITE level using the localization perspective in the following path:

**CAVE --> Menus --> upperair**

## 15.5 *Baseline Shapefiles*

A shapefile is made up of three components:

- .dbf** file
- .shp** file
- .shx** file

Baseline shapefiles will be updated using the shp option to config\_awips2.sh. They can be maintained as described in this section.

A site will have the option of renaming the files from the downloaded name itself, or it can allow the config\_awips2.sh (which is also aware of the AGMG naming convention) to perform the renaming, so the files do not have to be renamed for AWIPS II purposes. The script itself will rename the files to their proper AWIPS I names in /data/fxa/nationalData.

For example, the public forecast zones can be named c11-zone.shp OR z\_mmddy.shp. Both will be recognized by config\_awips2.sh. If the shapefile is left as z\_mmddy.shp, the script will rename it to c11-zone.shp when it imports the file.

The tool works in this way: When the script is run with the shp argument, it will check for updated files, which are newer than those at the import time of the corresponding table in the /awips2/edex/data/utility/edex\_static/base/shapefiles directory (maps

database). If any are found, it will copy them into the appropriate sub directory in /awips2/edex/data/utility/edex\_static/base/shapefiles, and import them into the database automatically. It also makes a backup of the old shapefiles in the following form:

**YYYYMMDD-filename.archive**

Where filename is the name of the shapefile, for example, usa\_lake.shp.

**IMPORTANT NOTE:**

AWIPS II relies on accurate shapefiles. If you notice a problem with an application using a shapefile that has been updated, do not try and re-import the same shapefile. Call the NCF, who has procedures on how to import the archived shapefile. Every time you re-run config\_awips2.sh with the shp option, it will remove the archived shape files so you may lose the “good” ones.

There are two options available to download the shapefiles from VLab:

1. Bring up a browser from an AWIPS workstation (LX) and go to: [https://vlab.ncep.noaa.gov/object\\_storage/awips/maps/](https://vlab.ncep.noaa.gov/object_storage/awips/maps/) or go directly to: [https://vlab.ncep.noaa.gov/object\\_storage/awips/maps/currentBaseline/](https://vlab.ncep.noaa.gov/object_storage/awips/maps/currentBaseline/) for the most recent baseline files.
  1. Enter in your NOAA LDAP credentials minus the @[noaa.gov](https://noaa.gov)
  2. Click on the file that you need to download the shapefile. Make sure you select the "save file" option.
  3. Copy the saved file from the ~/Downloads directory to the appropriate destination directory from a terminal window
2. From a terminal window on the Linux workstation (LX) use wget to download the file (e.g., wget [https://vlab.ncep.noaa.gov/object\\_storage/awips/maps/currentBaseline/GaccPSA\\_2011.dbf](https://vlab.ncep.noaa.gov/object_storage/awips/maps/currentBaseline/GaccPSA_2011.dbf))
  1. If you aren't given the opportunity to provide your username and password through a dialog you can pass the username by adding --http-user="NOAA\_LDAP\_USER\_NAME" to wget
  2. The password would need to be set within ~/.wgetrc using a format of "http\_password = Place\_password\_here" in order to prevent passing the password at the command line.

Shapefiles contain data sets for the entire United States, and, where applicable, its territories. The shapefiles and their primary data content are shown in Table 15.5-1.

**Table 15.5-1. Shapefiles**

Shapefile	Primary Contents
c11-zone	Public Forecast Zones
usa_cwa	County Warning Area (CWA) boundaries

marine_zones	Marine zone boundaries
coastal_zones	Coastal zones
offshore_zones	Offshore marine zones
high_seas_zones	High seas marine zones
fs1-w88d	WSR-88D locations
Basins	River basin boundaries
usa_rfc	RFC area boundaries
usa_lake	Lakes and other water boundaries
usa_wsfo	Redefining areas
timezones	Time zone boundaries
firewx	Fire Weather Zone
marine_total	Partial marine zones backup
routes	Interstate, US, State highways

### 15.6 *Modifying Shapefiles + Areas*

Shapefiles provide a complete non-topological description of two-dimensional geometric shapes, in three files:

<b>filename.shp</b>	shape description
<b>filename.shx</b>	index (shape to attributes)
<b>filename.dbf</b>	attributes

The shape of each geometric (spatial) object is a point, line, or polygon, and it is described completely and in sequential order by the **\*.shp** file. Attributes for each shape are stored sequentially in the same order by the file **\*.dbf**, using the dBASE III+ Database File Structure. An index of shapes to attributes is maintained in the **\*.shx** file. The shapefile format is documented online at <http://www.esri.com>. By convention, a shapefile is associated by one prefix file name. The contents of the **\*.dbf** file can be changed without damaging the index relationship to **\*.shp** as long as dBASE records are not added, deleted, or reordered. Shapefiles can be renamed, provided that all three components are given the same file name and the extensions are not changed.

Each entry provides an image of the shapefile. When the geographic area is not obvious, the shapefile is shown as darker points or lines on a lighter background. Space is conserved using the “zip” compression technique. Public domain software to extract **\*.zip** files is available for most operating systems and hardware environments from <ftp://ftp.uu.net/pub/archiving/zip/>. The **unzip** utility (**unz520x.tar.Z**) is mirrored here for NWS users. Make sure that the **\*.zip** file has been downloaded using a binary transfer method.

<b>filename.zip</b>	compressed (zip)
<b>filename.gif</b>	Graphics Interchange Format
<b>filename.txt</b>	flat text listing of <b>filename.dbf</b>

Descriptions of the catalog entries follow.

- **Files Prefix:** Shows the extensions of the three component files of the shapefile
- **Naming Convention:** A description of the name of the shapefile. Most data in the catalog have a two-letter prefix for the type of data and the date in **ddmmyy** format.
- **Location:** Directory in Catalog (URL)
- **Shapefile Type:** Type of shape {point, polyline, polygon}
- **Source:** Origin of shape and attribute information
- **Last Modified:** Last date shapes or attributes modified
- **Attributes**
  - Field:** dBASE field name (1 to 10 characters)
  - Type:** Field type {character, numeric, logical, date}
  - Width, dec:** Field type specifications: {character: width = # characters} {logical: width = 1} {date: width = 8} {numeric: width = # digits, dec = # decimal places}
  - Description:** Brief statement of field usage

An example follows.

**Files Prefix:** c11-zone.shp.Z/.shx/.dbf - where .shp, .shx, .dbf are the extensions of the three component files of the shapefile

**Naming Convention:** z\_ ddmmyy .shp/.shx/.dbf

**Location:** VLab

**Shapefile Type:** polygon

**Attributes:** Refer to Table 15.6-2.

**Table 15.6-2. Zone Attributes**

Field Name	Type	Width, decimal	Description
STATE	Character	2	[ss] State abbreviation (U.S. Postal Standard)
ZONE	Character	3	[ZZZ] Zone number, from WSOM C-11
CWA	Character	3	County Warning Area, from WSOM C-47
NAME	Character	254	Zone name, from WSOM C-11
STATE_ZONE	Character	5	[sszzz] state+ (“00”+zone.trim).right(3)
TIME_ZONE	Character	2	[tt] Time zone, 2 chars if split
FE_AREA	Character	2	[aa] Cardinal area of state (occasional)
LON	Numeric	10,5	Longitude of centroid (decimal degrees)
LAT	Numeric	9,5	Latitude of centroid (decimal degrees)
SHORTNAME	Character	32	Shortened zone name

## 15.7 How to Download Shapefile Data

Follow these steps to download shapefile data.



1. At one workstation, if any D2D applications or text display applications are running, exit the D2D and text display applications.
2. Open a Terminal window at a workstation and log in as the **root** user.
3. Change user accounts to **fxa**.

**TYPE:** `su - fxa`

4. Change to the **nationalData** directory.

**TYPE:** `cd $FXA_DATA/nationalData`

5. Save the current files by entering the following commands, which use zone forecast area boundary files as examples:

**TYPE:** `mv c11-zone.dbf c11-zone.dbf.orig`

**TYPE:** `mv c11-zone.shp.Z c11-zone.shp.Z.orig`

**TYPE:** `mv c11-zone.shx c11-zone.shx.orig`

For other types of shapefiles, repeat the same procedure and save the downloaded files in **\$FXA/nationalData** giving them new file name.

Please see the two options that are discussed in Section 15.5 to download the files.

6. As an example, for Zone Forecast Area Boundaries, download the file using the following command:

**TYPE:** `wget z_ddmmyy.* $FXA_DATA/nationalData/`

Where **dd** is the two digit date, **mm** is the two character month, and **yy** is the two digit year. Three files will be returned with the extensions **dbf**, **shp.Z**, and **shx**.

7. For other shapefiles substitute the correct file name in Step 6, as shown in Table 15.7-1.

**Table 15.7-1. Shapefile Download Commands**

Shapefile Format	wget Command
CWA	<code>wget w_ddmmyy.*</code>
Partial Service Backup	<code>wget wtddmmyy.*</code>
Coastal Marine Zone Area Forecast	<code>wget mzddmmyy.*</code>
Offshore Marine Zone Area Forecast	<code>wget ozddmmyy.*</code>
High Seas Marine Zone Area Forecast	<code>wget hzddmmyy.*</code>
WSR-88D Locations	<code>wget w8ddmmyy.*</code>
River Basin Boundaries	<code>wget baddmmyy.*</code>
RFC Area Boundaries	<code>wget rfddmmyy.*</code>
For Lakes and other Water Bodies	<code>wget lkddmmyy.*</code>
Interstate Highways	<code>wget inddmmyy.*</code>
Redefining Area	<code>wget usa_wsfordmmyy.*</code>
Time Zones	<code>wget tzddmmyy.*</code>
Marine Zones Partial Backup	<code>wget mtddmmyy.*</code>

Shapefile Format	wget Command
Cities	wget ciddmmyy.*
States	wget s_ddmmyy.*
Routes	wget rdddmmyy.*
Fire Weather	wget fzddmmyy.*

### 15.8 Load and Activate the New Data on AWIPS

1. Change to the **scripts** directory. As user **root**,

**TYPE:** `cd /data/fxa/sdc`

2. Run the configuration script for shapefiles.

**TYPE:** `./config_awips2.sh shp LLL`

**Note:** The fsl-w88d shapefile is not processed by `config_awips2.sh shp` option. It's configured using `config_awips2.sh ndm`.

3. After the shapefile load completes, verify that all the changes were made properly. Start CAVE on a workstation and verify that the new map backgrounds are properly displayed by calling up various map scales. Also, run WarnGen and create test WarnGen messages to ensure that the proper zones are used.
4. Once you are satisfied that the update maps look correct, delete the **.orig** files.

### 15.9 Downloading Local Shapefiles

Local shapefiles can be imported into the maps database using the automation tool. Files should be staged in the following location:

`/awips2/edex/data/utility/edex_static/site/LLL/shapefiles`

The shapefiles should be added in a manner similar to the following:

`submenu/shape_desc/shapefile.(dbf|shp|shx)`

It is important to note a few things about this structure. First, the name of the shape file is determined by its parent directory and NOT by the name of the shapefile. Also, all underscore characters “\_” will be translated to spaces in the CAVE menu.

Second, the directory name of **SUBMENU** is optional, but if desired this will create a submenu on your Maps menu in CAVE. This means that you can have a shapefile staged in this manner:

`/awips2/edex/data/utility/edex_static/site/LLL/shapefiles/shape_desc/shapefile.shp`

It will also create a menu entry in CAVE under **Maps** named **shape\_desc**.

Any shapefiles staged within more than one directory will be listed under a submenu in the Maps pulldown in CAVE, which is named the same as the directory itself. To clarify,

whatever text you put in for *submenu* above will be the text shown as the **submenu** on CAVE.

For example, the following staging:

```
/awips2/edex/data/utility/edex_static/site/LLL/shapefiles/local_roads/dirt_roads/dirtroad.shp
```

```
/awips2/edex/data/utility/edex_static/site/LLL/shapefiles/local_roads/grass_roads/grassroad.shp
```

will create the following structure in the menu of CAVE:

```
Maps → local roads → dirt roads
      → grass roads
```

Finally, it is important to note that only ONE **shp**, **dbf**, and **shx** file can reside in the final directory for staging shapefiles. This is **NOT** valid staging:

```
/awips2/edex/data/utility/edex_static/site/LLL/shapefiles/city_parks/playgrounds.shp
```

```
/awips2/edex/data/utility/edex_static/site/LLL/shapefiles/city_parks/bigfieldsa.shp
```

Because there are two .shp files under local\_roads, which would be used to create the “city parks” menu. In this case you probably want to create two subdirectories under city\_parks – one named *playgrounds/* and another *bigfields/*.

The last important thing to note is that the directory name of *shape\_desc* will determine the table name into which the shapefiles will be imported. It also determines the name of the map bundle created. The name of the map bundle is case sensitive, while the table name will always be all lower case. All underscore characters (‘\_’) in *shape\_desc* will be converted to spaces when creating the Maps menu name.

For example, the following shapefiles will create **mapdata.oax\_county** schema in the maps database and create a new entry OAX County directly on the main Maps menu in CAVE:

```
/awips2/edex/data/utility/edex_static/siote/OAX/shapefiles/OAX_County/OAX_County.dbf
```

```
/awips2/edex/data/utility/edex_static/siote/OAX/shapefiles/OAX_County/OAX_County.shp
```

```
/awips2/edex/data/utility/edex_static/siote/OAX/shapefiles/OAX_County/OAX_County.shx
```

**Note:** The staged directory name does not have to match the file name of the shape file.

In this example, the shapefiles will create **mapdata.grr\_cwa\_roads** schema in the maps database, and will create a **Roads** submenu in the Maps pulldown within CAVE. Under the **Roads** submenu will be a selection **GRR CWA Roads**.

```
/awips2/edex/data/utility/edex_static/site/GRR/shapefiles/Roads/GRR_CWA_Roads/grr_cwa_roads.dbf
```

```
/awips2/edex/data/utility/edex_static/site/GRR/shapefiles/Roads/GRR_CWA_Roads/grr_cwa_roads.shp
```

```
/awips2/edex/data/utility/edex_static/site/GRR/shapefiles/Roads/GRR_CWA_Roads/grr_cwa_roads.shx
```

The name of the staging directory is used to create the database table name, as well as the map bundle XML file name. The bundle file name will be created in `/awips2/edex/data/utility/cave_static/site/LLL/bundles/maps`. For example, the first example above would create `OAX_County.xml` in this directory.

The label on the Maps menu in CAVE will match the name of the directory, except that every ‘\_’ in the directory name will be turned into a space.

The second example above would create `GRR_CWA_Roads.xml` in `/awips2/edex/data/utility/cave_static/site/LLL/bundles/maps/Roads`

**Note:** The bundle will only be written by **config\_awips2.sh** if the following is true: 1. It does not exist for 2. It exists and was created by **config\_awips2.sh**. This means that if a bundle has been edited by the localization perspective since its original creation by **config\_awips2**, it will *not* be overwritten.

Once everything is staged correctly, run the following to import the shapefiles staged into the database:

```
./config_awips2.sh shp LLL
```

When the force option (-f) is added to this command, it will also call the `config_ffmp_shapefiles` script to load the FFMP shapefiles.

**Note:** The `fsl-w88d` shapefile is not processed by **config\_awips2.sh shp** option. It’s configured using **config\_awips2.sh ndm**.

To remove a shapefile from the system, follow these steps. Note that, for these steps, the example is removing a shape file named `My_Shape_File`:

1. Remove the shapefile from the system. Identify the shapefile staging directory, and remove the *directory*

```
cd /awips2/edex/data/utility/edex_static/site/LLL/shapefiles
rm -rf My_Shape_File
```

2. Remove the map bundle XML file, which is also created, and which also has the same name as the staging directory.

```
cd /awips2/edex/data/utility/cave_static/site/LLL/bundles/maps
```

```
rm My_Shape_File.xml
```

3. Connect to the database, and drop the table.

```
su - awips
psql maps
DROP TABLE mapdata.my_shape_file;
DELETE FROM mapdata.map_version where table_name='my_shape_file';
\q
```

**Note:** If you are uncomfortable with any of these steps, call the NCF for assistance at 301.713.9344.

## 15.10 National Data Management (NDM) Files

The site data configuration automation tool will copy those national data management files, already maintained on the AWIPS system, into the endpoint for EDEX, which allows the software to ingest and localize properly based on the file.

**Note:** The sites should be instructed (encouraged) to copy ndm updates to dx3 /awips2/edex/data/ndm and to the A-1 DIRECTORY as before.

/awips/fxa/data

/data/fxa/nationalData

The files that are supported are identified in **Table 15.10-1**.

**Table 15.10-1. NDM Files Supported by AWIPS II ndm Endpoint**

• Input File Name	• Staging Location	• Output
afos2awips.txt	/awips/fxa/data	afos_to_awips table in the fxatext database
afos_lookup_table.dat	/awips/fxa/data	/awips2/edex/data/utility/common_static/base/textdb/afos_lookup_table.dat
modelBufrStationInfo.txt	/awips/fxa/data	modelBufr.spi in /awips2/edex/data/utility/common_static/site/LLL/basemaps
MTR.primary MTR.goodness	/awips/fxa/data /	MTR.spi, MTR.primary, MTR.goodness in /awips2/edex/data/utility/common_static/site/LLL/basemaps
goesBufrStationInfo.txt	/awips/fxa/data	goesBufr.spi in /awips2/edex/data/utility/common_static/site/LLL/basemaps
poesBufrStationInfo.txt	/awips/fxa/data	poesBufr.spi in /awips2/edex/data/utility/common_static/site/LLL/basemaps
maritimeStationInfo.txt	/awips/fxa/data	BUOY.spi in

• Input File Name	• Staging Location	• Output
		/awips2/edex/data/utility/common_static/site/LLL/basemaps
metarStationInfo.txt	/awips/fxa/data	common_obs_spatial table in metadata database
textCCChelp.txt textNNNhelp.txt textOriginTable.txt textCategoryClass.txt	/awips/fxa/data	/awips2/edex/data/utility/common_static/base/textdb/
synopticStationTable.txt	/awips/fxa/data	edex_static/base/synopticStationTable.txt and common_obs_spatial table in metadata database
raob.goodness raob.primary	/data/fxa/nationalData	raob.spi in /awips2/edex/data/utility/common_static/site/LLL/basemaps
raobStationInfo.txt	/awips/fxa/data	common_obs_spatial table in metadata database
ispan_table.dat	/awips/fxa/data / localizationDataSets/LLL	ispan_table in /awips2/edex/data/utility/edex_static tree
fsl-w88d.dbf fsl-w88d.shp fsl-w88d.shx	/data/fxa/nationalData	radar_spatial table in metadata database.
national_category_table.dat	/data/fxa/nationalData	/awips2/edex/data/utility/common_static/base/textdb/national_category_table.template
afosMasterPIL.txt	/data/fxa/nationalData	/awips2/edex/data/utility/common_static/base/textdb/afosMasterPIL.txt

The NDM files are available on the NOAA Virtual Lab. To download a file enter the svn command from a terminal window on the AWIPS Linux workstation (LX):

```
svn export https://vlab.ncep.noaa.gov/svn/awips-ndm/trunk/FILE_NAME --username firstName.lastName
```

**Note:** The above command must be typed on single line.

**FILE\_NAME** is the file that you want to download.

**firstName.lastName** is your NOAA email address without the "@noaa.gov" extension.

The svn command will prompt you for your NOAA email password to authenticate your access for downloading this file.

Here is an example for downloading the station\_table.dat file:

```
svn export https://vlab.ncep.noaa.gov/svn/awips-  
ndm/trunk/station_table.dat --username wayne.martin
```

Here is output from the svn download:

```
A    station_table.dat
```

```
Export complete.
```

By running the following command, the user will be presented with a select menu allowing files to be copied into the ndm endpoint for EDEX to ingest and create the proper output file:

```
./config_awips2.sh ndm LLL
```

This task will need to be run whenever there are NDM file updates.

**Note:** The sites should be instructed (encouraged) to copy ndm updates to dx3 /awips2/edex/data/ndm and to the A-1 DIRECTORY as before:

```
/awips/fxa/data
```

```
/data/fxa/nationalData
```

# **Chapter 16**

## **Customization**



## Chapter 16. Customization

### Table of Contents

	<i>Page</i>
16.1 New CAVE User Setup and User Preference Setup .....	1
16.1.1 New CAVE User Setup .....	1
16.1.2 User Preference Setup .....	4
16.2 CAVE Menu Customization .....	5
16.3 Shapefiles .....	5
16.3.1 Local Shapefiles .....	6
16.3.2 Baseline Shapefiles .....	6
16.3.3 National Datasets Maintenance Updates .....	6
16.4 Radar Customization .....	7
16.4.1 How to Change the Default RPS Lists .....	7
16.4.2 Creating Radar-Specific Pre-localization RPS Lists .....	8
16.4.3 Adding Radar Four-Panel Displays .....	8
16.4.4 Changing Default Color Enhancements for Radar Imagery .....	8
16.4.5 Modifying the Default Radar Color Curves .....	9
16.5 Data Monitor: Looking in the Wrong Place for Data .....	9
16.6 Text Customization .....	11
16.6.1 Add Versions to Text Database .....	11
16.6.2 Updating the afos2awips.txt file .....	12
16.6.3 Adding Products to the Text Browser .....	13
16.7 Grid Definition Changes .....	14

### List of Exhibits

Exhibit 16.1.1-1. Initial CAVE Startup Dialog .....	2
Exhibit 16.1.1-2. Valid Connectivity Preferences Selected .....	3
Exhibit 16.1.1-3. CAVE Startup Screen .....	4

### List of Tables

Table 16.2-1. Baseline Contributions for CAVE-D2D .....	5
---------------------------------------------------------	---

Customization refers to all changes made to the system that are not required for site operation.

**NOTE:** This chapter continues to be a work in progress.

For more information on Customization in this manual, refer to Appendix V, Adding D2D Model Data into GFE, and Appendix X, Configuring `metarToShefFiler.xml`.

**DISCLAIMER:** If, after any customization, site problems are reported to the NCF, the NCF reserves the right to return your site to the baseliner configuration.

## 16.1 *New CAVE User Setup and User Preference Setup*

In AWIPS II, the user interface is provided through the Common AWIPS Visualization Environment (CAVE), which replaces the Display Two Dimensions (D2D) tool used in AWIPS, I..

### 16.1.1 *New CAVE User Setup*

AWIPS II does not generally distinguish CAVE users from computer users. Simply put, a CAVE user is a computer user who has access to the AWIPS II CAVE application.

Setting up a new CAVE user involves three steps:

1. A standard Linux account is established for the user.
2. CAVE and supporting AWIPS II components are installed for the new user. There are two ways this can be done.
  - a. The CAVE package may be installed onto the user's computer; or
  - b. The CAVE package can be installed on a shared drive that is accessible from the user's computer.
3. The user runs CAVE for the first time.

The first time a user runs CAVE, two events occur.

- First, a directory named *cave Data* is created in the user's home directory. CAVE uses the *cave Data* directory tree to store local copies of the various configuration files generated by CAVE.
- Second, the user is prompted for the information CAVE needs to connect to its EDEX server and begin operation. The dialog used is the *Connectivity Preferences* dialog. It is shown in Exhibit 16.1.1-1.

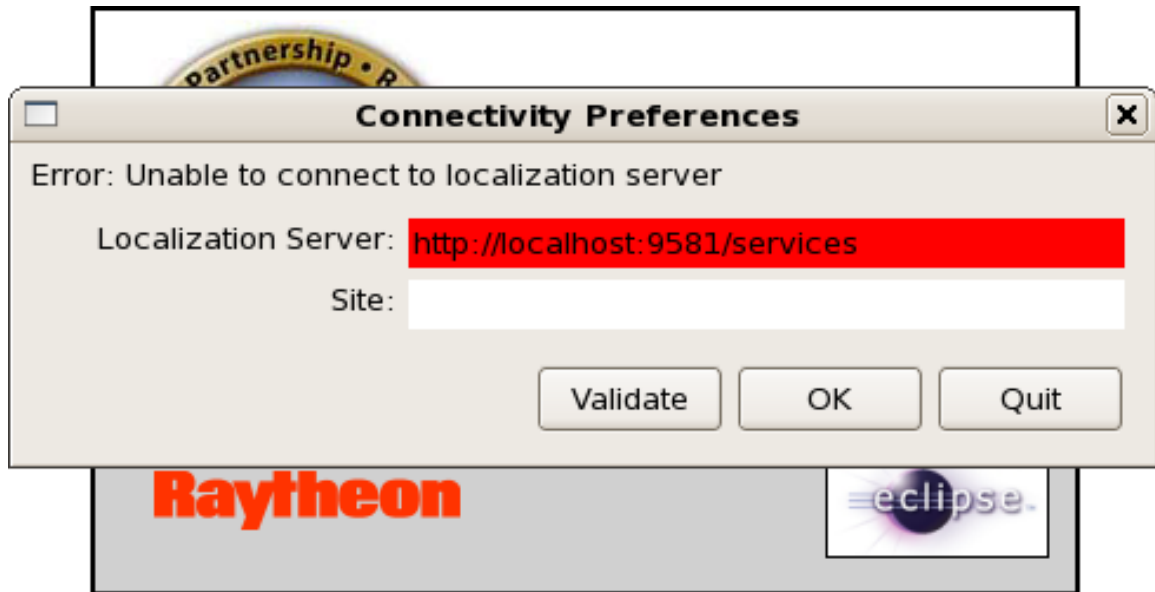

Exhibit 16.1.1-1. Initial CAVE Startup Dialog

The Initial CAVE Startup Dialog will only be displayed the first time that you use CAVE. This dialog is requesting two critical items of information: 1) the connection address of the EDEX localization server (highlighted in red); and 2) the localization site. The user will need to change *localhost* (in red highlight) to the IP address or DNS name of the EDEX localization server. After Site, enter the three character designator of the WFO.

Clicking *Validate* attempts to verify that the user-provided localization server is correct. If so, the red highlight is removed. Note that the message does not change. Also note that the Site is not validated.

**NOTE:** The text never changes from “**Error: Unable to connect...**”, even after a correct server location is entered and *Validate* is clicked.

**NOTE:** This screen can be bypassed without entering a value for the site; however, CAVE will not localize correctly!

Exhibit 16.1.1-2 shows the Connectivity Preferences with a valid localization server and site entered.

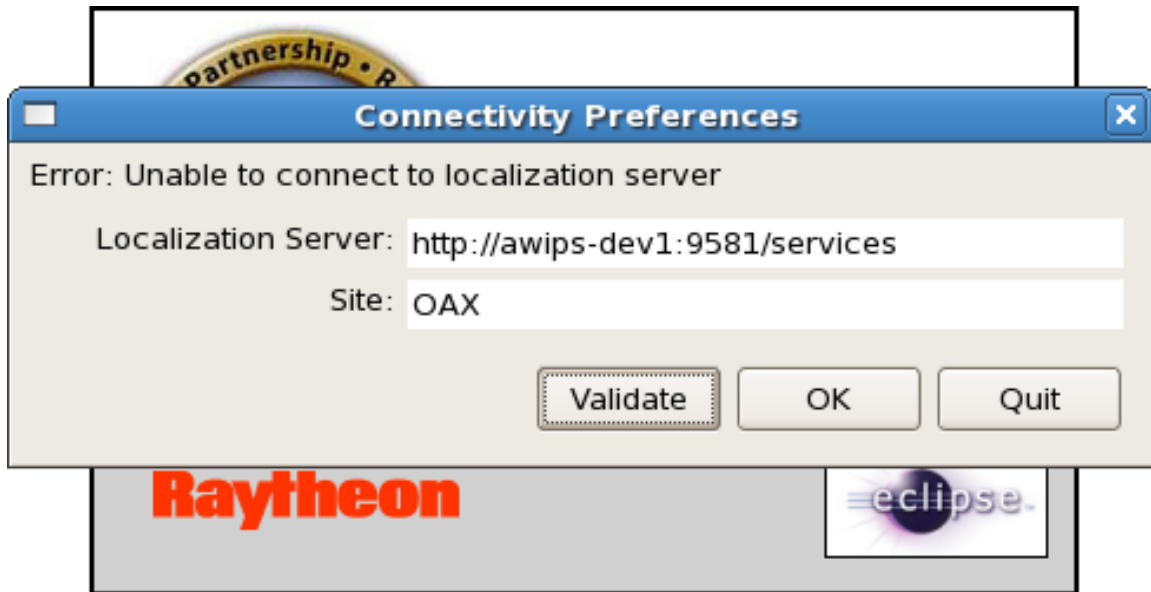
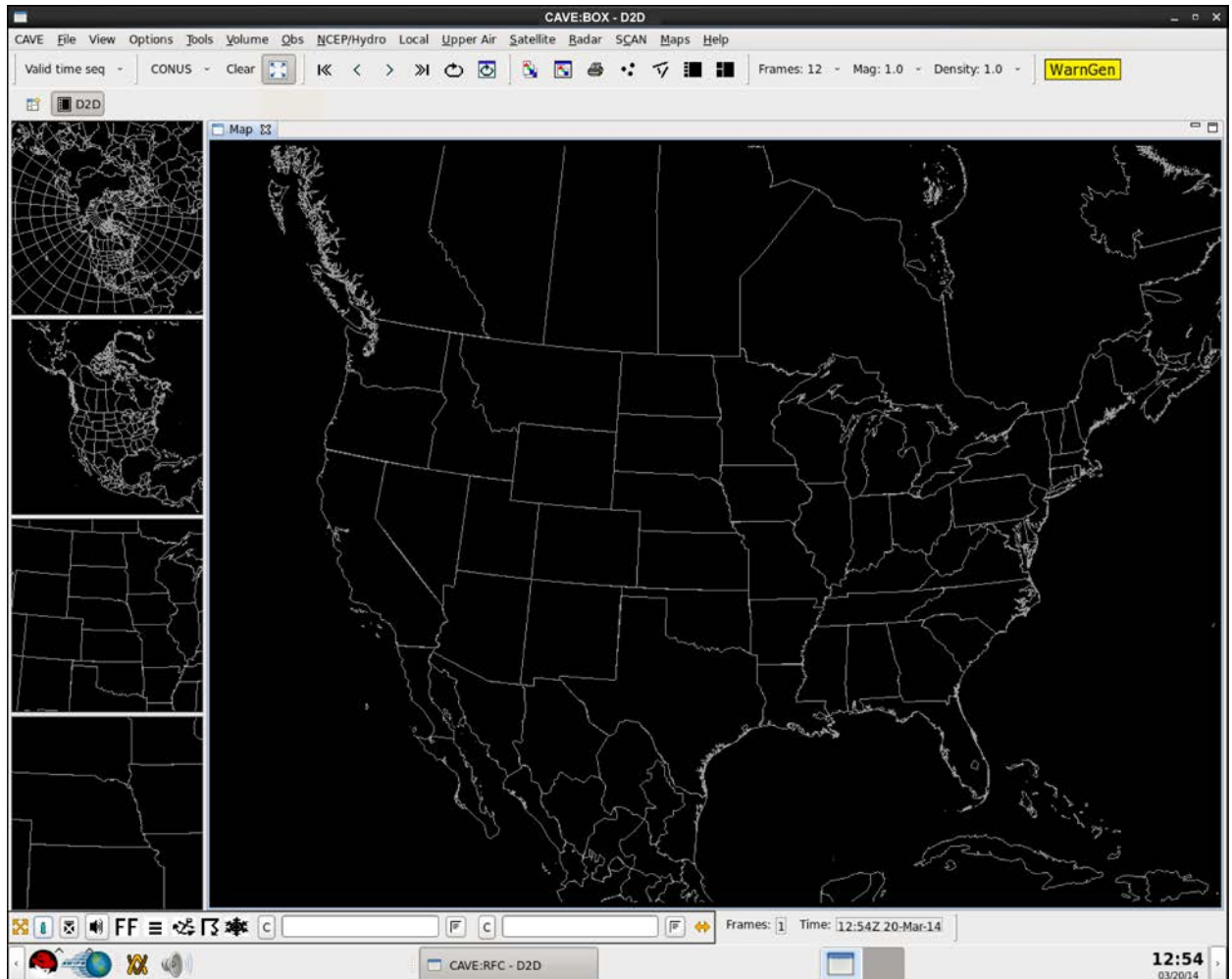

Exhibit 16.1.1-2. Valid Connectivity Preferences Selected

Clicking *OK* continues the CAVE startup.

This will bring up the CAVE Startup screen, shown in Exhibit 16.1.1-3.



**Exhibit 16.1.1-3. CAVE Startup Screen**

The user does not have to validate the localization server before clicking *OK*; however, if the localization server is invalid, a Connectivity Error dialog is displayed. A valid localization server must be specified before CAVE will start.

**Note:** It is also suggested that a valid localization site be entered; if the site is not valid, CAVE started in a default mode.

Clicking *Quit* exits CAVE without completing the startup.

**Note:** Once the initial startup of CAVE is complete, CAVE stores user preferences and other configurations in the caveData directory tree. In most situations there will be no need for the user to modify caveData directly.

### 16.1.2 User Preference Setup

Most user preferences (the main exception being the localization information discussed above) are pre-set when CAVE is first installed. Other preferences are set automatically

by CAVE as the user interacts with the CAVE GUI. For example, CAVE originally opens with the 5-panel D2D perspective selected, with a default window that is somewhat smaller than a typical computer monitor. If the user resizes the CAVE window, opens another perspective (such as the Hydro perspective), switches back to the D2D perspective, and then exits CAVE, when CAVE restarts, it will be the same size as before and will display the same perspectives as before. (Data displayed in CAVE will not be reloaded, however.) This “state memory” is handled automatically by the Eclipse RCP framework used in CAVE, and no user interaction is required.

The individual CAVE user has the option of changing many of the default preferences as needed. Most changes are made using dialogs that are similar to the corresponding application dialogs in AWIPS I. For example, CAVE defaults the image backgrounds in the D2D perspective to black. If the user desires, the background color can be changed using *Options->Set Background Color...* in the D2D perspective menu.

## 16.2 CAVE Menu Customization

The CAVE menu is designed to be highly customizable through XML files. The menu system allows considerable flexibility in structuring menus. It is possible to structure menus in as few or as many files as desired to improve manageability. The baseline CAVE-D2D menu structure is defined in standard Eclipse RCP plugin.xml files in the following plug-ins:

`com.raytheon.viz.ui.personalities.awips/plugin.xml`

`com.raytheon.uf.viz.d2d.ui/plugin.xml`

Individual CAVE-D2D plug-ins builds on these menus by making their own baseline contributions. The baseline contributions for CAVE-D2D are shown in Table 16.2-1.

**Table 16.2-1. Baseline Contributions for CAVE-D2D**

Plug-In Menu Contribution Path	CAVE-D2D Menu Items
menus/lightning	Lightning plots under Obs>Lightning
menus/radar	kxxx radar and Radar menus
menus/satellite	Satellite menus
menus/xml	Volume Browser sub menu
menus/warnings	Warning displays under Obs>Hazards
menus/mos	Local menu
menus/obs	Contributions in Obs
menus/upperair	Contributions in Upper Air

## 16.3 Shapefiles

There are two types of shape files: Local shapefiles and Custom shapefiles

### 16.3.1 Local Shapefiles

Local shapefiles can be imported into the maps database using the automation tool. Files should be staged in the following location:

```
/awips2/edex/data/utility/edex_static/site/LLL/shapefiles
```

The shapefiles should be added in a manner similar to the following:

```
shape_desc/shapefile.(dbf/shp/shx)
```

The directory name of shape\_desc will determine the table name into which the shapefiles will be imported. For example, the following shapefiles will create mapdata.oax\_county schema in the maps database:

```
/awips2/edex/data/utility/edex_static/site/OAX/shapefiles/OAX_
County/OAX_County.dbf
```

```
/awips2/edex/data/utility/edex_static/site/OAX/shapefiles/OAX_
County/OAX_County.shp
```

```
/awips2/edex/data/utility/edex_static/site/OAX/shapefiles/OAX_
County/OAX_County.shx
```

**Note:** The staged directory name does not have to match the file name of the shape file.

The name of the staging directory is used to create the database table name, as well as the map bundle XML file name. The bundle file name will be created in /awips2/edex/data/utility/cave\_static/site/LLL/bundles/maps. For example, the above would create OAX\_County.xml in this directory.

The label on the Maps menu in CAVE will match the name of the directory, except that every '\_' in the directory name will be turned into a space.

Once everything is staged correctly and you are ready to import the shapefiles staged into the database, refer to the *AWIPS II Site Migration Guide*.

### 16.3.2 Baseline Shapefiles

Please refer to Chapter 15 for more information.

### 16.3.3 National Datasets Maintenance Updates

The sites should copy the updated National Datasets Maintenance (NDM) files to dx3: /awips2/edex/data/ndm and to the AWIPS I directories /awips/fxa/data and /data/fxa/nationalData.

## 16.4 Radar Customization

### 16.4.1 How to Change the Default RPS Lists

The primary function of the Routine Product Selection (RPS) List Editor is to create or edit a list of up to 150 radar products and send the list to a WSR-88D (Open) Radar Product Generator (ORPG/RPG) for display in the next radar Volume Scan(s). [**Note:** In the RPS application, each RPS list uses one VCP only.]

Follow these steps to modify the Default Storm Mode and/or the Clear-Air Mode RPS lists.

1. On any workstation, open a Terminal window.
2. As user **awips** on **DX1**, change to the **rps-lists** directory.

**TYPE:**        **cd /data/fxa/rps-lists**

3. Create a new RPS list by using the RPS List Editor and save the newly created file (e.g., **<rps-new>.VCP<xx>.rps**).

**Note:** This file needs to be saved in /data/fxa/rps-lists

4. **TYPE:**        **ls -ltr**
  - Displays the RPS list files included in the directory from earliest to latest (**<rps-new>.VCP<xx>.rps** should be listed)
5. Copy the new RPS list into the storm mode and clear-air mode files.

Type all on one line:

**TYPE:**        **cp <rps-new>.VCP<xx>.rps  
/awips2/rcm/data/config/drop-  
ins/<RPG\_ID>.storm.VCP<xx>**

**TYPE:**        **scp <rps-new>.VCP<xx>.rps  
dx2:/awips2/rcm/data/config/drop-  
ins/<RPG\_ID>.storm.VCP<xx>**

**TYPE:**        **cp <rps-new>.VCP<xx>.rps  
/awips2/rcm/data/config/drop-ins/<RPG\_ID>.clear-  
air.VCP<xx>**

**TYPE:**        **scp <rps-new>.VCP<xx>.rps  
dx2:/awips2/rcm/data/config/drop-  
ins/<RPG\_ID>.clear-air.VCP<xx>**

**Note:** The above files must be copied to DX2 as well.

6. If desired, go to the RPS List Editor and send the new default.



**Note:** The default RPS list will be sent to the radar whenever the radar's scan mode changes or the line from AWIPS to the radar is down. If the radar is in clear-air mode, the clear-air mode list will be sent. If in storm mode, the storm mode file will be sent.

### 16.4.2 Creating Radar-Specific Pre-localization RPS Lists

The creation of radar-specific pre-localization RPS applies only to AWIPS I. There is no localization process that copies RPS files in AWIPS II.

### 16.4.3 Adding Radar Four-Panel Displays

There are up to two types of files that must be edited to add a radar 4-panel display to the D-2D menu: Menu files and bundle files. Both types of files can be edited in the CAVE Localization perspective. To make the new display available for all users, create SITE-level override versions of these files. It is possible to create WORKSTATION- or USER-level overrides as well. If an override already exists, make a backup before editing it.

Be aware that, for WSR-88D displays, there are often dual-pol and non-dual-pol versions of a menu file. The dual-pol versions are in a subdirectory named dualPol.

The steps for adding radar four-panel displays follow.

1. Start CAVE on a workstation and open the Localization perspective.
2. Navigate to the **CAVE -> Menus -> radar** folder in the file browser. Determine where in the menu you want the new display to be made available. For example, existing four-panel displays are in menu file names like *baseRadarFourPanel.xml* and *baseRadarFourPanelBestRes.xml*. If you want the display to be in a different menu, trace through radar menus starting with *radarindex.xml* to find the correct file.
3. Edit the menu file determined in the previous step. If there is an existing bundle file that provides the kind of display you want, you can copy and paste an existing `<contribute>` element, changing the product code or elevation parameters as desired. Change the menuText attribute to set the name that will be displayed on the menu item. Change the id attribute to a value that is not used by other menu items.
4. If no existing bundle file is appropriate, create or copy an existing bundle file in the **CAVE -> Bundles** folder. Reference this bundle in the menu entry added in the previous step.
5. Restart CAVE (or start a new instance of CAVE) to test the new menus. **Note:** When testing your new four-panels, be sure the radar is in the proper VCP mode to supply the slices on the four-panel. Also be sure that you have sent an RPS list from AWIPS to the radar which contains the products on your four-panel display.

### 16.4.4 Changing Default Color Enhancements for Radar Imagery

Follow these steps to change the default color enhancements for radar imagery.

1. Start CAVE on a workstation and open the Localization perspective.

2. Determine the color curve you want to use. These can be found in the Localization perspective file browser under **CAVE -> Color Maps -> Radar**.
3. For each radar product that you want to assign a new color map to, determine the product code. These can be found by looking at the radar menu or bundle files. On the dx3 or dx4, the file `/awips2/edex/data/utility/common_static/base/radarInfo.txt` lists products with their associated codes.
4. Create a SITE-, WORKSTATION- or USER- level override of **CAVE -> Style Rules -> radarImageryStyleRules.xml**. If the override already exists, create a backup before editing it.
5. Look for the `<styleRule>` element containing `<parameter>n</parameter>` where *n* is the product code. Change the value of the `<defaultColormap>` element to reference the color curve you want to use. Note that color maps are organized in subfolders and the '/'-separated path must be used here, for example, "Radar/OSF/SRM Radial Velocity".  
  
If the `<styleRule>` element contains multiple `<parameter>` elements, all the referenced products will be affected. If this is not desired, make a copy of the original `<styleRule>` element, edit the copy's list of parameters so that it contains only relevant products, and then remove those parameters from the original rule.
6. Restart CAVE (or start a new instance of CAVE) to test the new style rules.

#### 16.4.5 Modifying the Default Radar Color Curves

Follow these steps to modify the default radar color curves.

1. Navigate to **CAVE -> Color Maps -> Radar** in the file browser.
2. Double click on the color map you want to edit. This will open the color map editor for the file. XML and plain text editors are available by clicking on the relevant tab at the bottom of the editor.
3. Edit the file and save it.
4. Restart CAVE (or start a new instance of CAVE) to test the new color maps.

### 16.5 Data Monitor: Looking in the Wrong Place for Data

If the data (available within AWIPS II) is missing in the Data Monitor, then the Data Monitor is looking for the data in the wrong place.

Follow these steps to view the data monitor files.

1. Log in to PX1. As user **root** (or any user in falpha group), change to the directory where the Data Monitor files reside.

**TYPE:**            `cd /data/fxa/A2_SysMonitor/config`

2.    **TYPE:**            `ls *.xml`

Find all the data files ending in **.xml** that are used by the Data Monitor (e.g., **satellite.xml**, **grid.xml**, **radar.xml**, etc.).

3. Edit the file you need using a text editor. The **radar.xml** sample is shown as an example below.

```
<radar>
  <data>
    <productname>KLWX 8-Bit Base Reflectivity (Z) elev0_5</productname>
    <sqltxt>SELECT reftime FROM radar WHERE productcode = '94' AND location_rda_id =
'KLWX' AND primaryelevationangle = '0.5' ORDER BY reftime DESC LIMIT 1</sqltxt>
    <warnthresh>720</warnthresh>
    <errorThresh>1440</errorthresh>
  </data>
</radar>
```

- The text inside the `<productname>` tag will be the text displayed on the data monitor page.
  - The text in the `<sqltxt>` tag is the SQL query to be executed against the metadata database. This returns the latest reftime of the product. This is what is used to compare to the threshold values.
  - The text in the `<warnthresh>` tag is the time, in seconds, where the data is considered late since its last arrival. This will be displayed with a yellow caution symbol.
  - The text in the `<errorthresh>` tag is the time, in seconds, where the data is considered very late since its last arrival. This will be indicated by a red X symbol in the data monitor.
4. If the data is missing in the Data Monitor but not in AWIPS, the Data Monitor may be using the wrong SQL query to look for times in the database. You should double check the SQL command, possibly even using `psql` or `pgadmin` to verify that it works.
  5. Save the modified **.xml** file and observe the next time that the Data Monitor is refreshed in the browser.

### ***16.5.1 How to Add or Delete a Product from the Data Monitor***

To add or delete a product from the Data Monitor, begin by completing steps 1 through 4 in section 16.5 Data Monitor: Looking in the Wrong Place for Data. Then do the following.

#### ***To add a product***

1. To **add** a product, add another set of XML tags between, and including the `<data>` `</data>` tags. Modify the necessary XML elements as desired.
2. Save the modified **.xml** file and observe the next time that the Data Monitor is refreshed in the browser..

#### ***To delete a product***

1. To **delete** a product, simply remove the lines between, and including, the <data> </data> tags.
2. Save the modified **.xml** file and observe the next time that the Data Monitor is refreshed in the browser.

## 16.6 Text Customization

### 16.6.1 Add Versions to Text Database

The **textdb -v CCCNNNXXX n** command can be used to change the number of versions stored “on the fly” to **n** versions (where **n** is an integer).

For example, to change the number of versions of the **LAXFLSSAN** products from **2** to **10**, as user **fxa** or using your individual user account, enter the command:

```
TYPE:      textdb -v LAXFLSSAN 10
```

This command can be used to increase or decrease the number of versions stored.

If a site needs to change all the **FLS** products to **n** versions, rather than individually issuing this command for each product, use the following procedure as user **postgres** on **dx1**,

```
TYPE:      psql fxatext << !
TYPE:      update textproductinfo
TYPE:      set versionstokeep = 10
TYPE:      where nnnid = 'FLS';
TYPE:      !
```

By changing the value of **versionstokeep** and **nnnid**, this procedure can be adapted to change the number of versions stored for other product categories.

The versions of each product are stored in a circular queue. An individual product will need to wait until its queue pointer for that product is set to the last element in the queue before the number of versions change.

You can list the FLS products in the **fxatext** database by typing the following sequence of commands:

```
TYPE:      psql fxatext << !
TYPE:      select * from textproductinfo
TYPE:      where nnnid = 'FLS';
TYPE:      !
```

You may want to do this before and after you “update” the **versionstokeep** table.

### 16.6.2 Updating the *afos2awips.txt* file

The **afos2awips.txt** file maps AFOS PILs to WMO headers. When an AWIPS site transmits a locally created product via the AWIPS WAN, the locally created product must be transmitted by its WMO header. The **afos2awips.txt** file is the configuration file that translates the site's local AFOS PILs into WMO headers. If a product is missing from the **afos2awips.txt** file, that product will not be transmitted via the AWIPS WAN to the NCF for distribution via the SBN.

The **afos2awips.txt** file is a “living” document that needs to be updated in a timely manner to meet AWIPS WAN transmission requirements. As a “living” document, AWIPS sites will need to occasionally get and install updates of the **afos2awips.txt** file from the VLab. AWIPS sites should verify that all of their locally created products are included in the **afos2awips.txt** file. To expedite corrections to the **afos2awips.txt** file, changes should be sent to the NWS Data Managers at **nws.dm@noaa.gov**. The **afos2awips.txt** file is updated weekly. The **afos2awips.txt** file should always be checked to ensure that site products are correct.

#### *Reviewing the updated afos2awips.txt file*

Complete these steps to review the updated *afos2awips.txt* file:

1. At an AWIPS workstation, open a Terminal window. Sites can temporarily store the updated **afos2awips.txt** file in the **/awips/fxa/awipsusr** directory for review. As user **fxa**,
2. **TYPE:**            **cd /awips/fxa/awipsusr**
3. Logon to VLab and download the *afos2awips.txt* file.

The downloaded **afos2awips.txt** file is now stored on the AWIPS workstation in the **/awips/fxa/awipsusr** directory. Review the downloaded file to ensure it includes all site locally created products.

Note: The old software will still read NDM from the original location, so sites should still follow the old update procedures as well. For example according to <http://www.nws.noaa.gov/ndm/>, *afos2awips.txt* should be updated in **/awips/fxa/data** on all devices.

#### *Updating the afos2awips.txt file*

On DX3, copy the *afos2awips.txt* file to **/awips2/edex/data/ndm**. This will update the appropriate database table. To confirm the changes, after the file is taken out of **/awips2/edex/data/ndm** check in both the dx3 and dx4 edex-ingest logs by typing: **grep afos2awips /awips2/edex/logs/edex-ingest-*<yyyymmdd>*.log** to verify that it was processed. From the *fxatext* database, the user must type: **select \* from afos\_to\_awips where afosid = '<CCCNXX>'** where CCC is the node NNN is the product type and XXX is the site id.

### 16.6.3 Adding Products to the Text Browser

Complete the following steps to add products to the text browser. [**Note:** These steps are written as though your AWIPS site is localized to **MTR**. When carrying out these steps, replace **MTR** with your own AWIPS three-letter localization ID.]

1. Exit all D2D and text workstation sessions on the workstation.
2. Open a Terminal window on **DX3**, and as user **fxa**, change to the localization directory for your site.

**TYPE:**        `cd /awips/fxa/data/localization/MTR`

3. Type, all on one line:

**TYPE:**        `cp /data/fxa/nationalData/afosMasterPIL.txt MTR-afosMasterPIL.txt`

4. If the product you wish to add to the text browser is not in MTR-afosMasterPIL.txt, edit MTR-afosMasterPIL.txt to add it (add in alphabetical order).

5. Copy the edited file back to the nationalData directory. Type, all on one line:

**TYPE:**        `cp MTR-afosMasterPIL.txt /data/fxa/nationalData/afosMasterPIL.txt`

6. Type, all on one line:

**TYPE:**        `cp /awips/fxa/data/textCategoryClass.txt MTR-textCategoryClass.txt`

7. Edit MTR-textCategoryClass.txt to add the product and class in which it is to be available in the text browser.

A sample line would look like **AFD 1 2 15 16**

Where **AFD** = Area Forecast Discussion

The **numbers** that follow AFD indicate which classes the data is in. So the AFD would be available in the public (1), aviation (2), national obs. (15), and narr/disc./codes (16) class pulldown of the text browser.

8. Add products that are not in MTR-textCategoryClass.txt alphabetically.
9. Type, all on one line:

**TYPE:**        `cp MTR-textCategoryClass.txt /awips/fxa/data/textCategoryClass.txt`

10. Change to the scripts directory to rerun localization. Still as user fxa,

**TYPE:**        `cd /data/fxa/sdc`

**TYPE:**        `./config_awips2.sh ndm MTR`

11. Close the Terminal window. Then select afosMasterPIL.txt and textCategoryClass.txt and copy to other workstations.

12. Start D2D and text workstations and bring up text browser to test whether your changes are evident.

## 16.7 Grid Definition Changes

If a grid definition's geospatial information is changed (edex\_static/.../grib/grids/\*) or if sub-grid definitions are changed (especially <centerLatitude> and <centerLongitude> in edex\_static/.../grib/subgrids/\* or edex\_static/.../grib/defaultSubGridCenterPoint.xml) such that the all of the lat/lon coordinates are less than or equal to 0.1 degrees different, it may be necessary to clear out existing data or repair the grid definition in the metadata database.

### Correcting sub-grid definitions

If a sub-grid's definition is changed, it is possible to use the sub-grid checking tool that was provided with OB15.1.1. Refer to the instructions in /data/local/subgrid-offset-check/README for guidance on running this tool.

### Clearing out grid data

If a primary grid's definition is changed as described above, it may be necessary to clear out all existing model data that reference the grid. The steps below describe how to clear out specific gridded data from the metadata database and HDF5 stores.

- 1 First, obtain the list of grid coverage IDs for grids known to have changed based on the model dataset IDs. Substitute "'Model1', 'Model2', ..., 'ModelN'" below with those dataset IDs.

```
select distinct gridcoverage.id from grid,grid_info,gridcoverage where
grid.info_id=grid_info.id and grid_info.location_id=gridcoverage.id and
grid_info.datasetid in ('Model1', 'Model2', ..., 'ModelN');
```

- 2 Next, obtain the list of all models that use those grid coverage IDs. (There may be more than the list of known model names.) Substitute "ID1, ID2, ... IDn" with the list of numbers obtained above.

```
select distinct grid_info.datasetid from grid,grid_info,gridcoverage where
grid.info_id=grid_info.id and grid_info.location_id=gridcoverage.id and gridcoverage.id
in (ID1, ID2, ..., IDn);
```

- 3 Delete grid records from the database that reference the grid coverage IDs.

```
delete from grid using grid_info,gridcoverage where grid.info_id=grid_info.id and
grid_info.location_id=gridcoverage.id and gridcoverage.id in (ID1, ID2, ..., IDn);
delete from grid_info using gridcoverage where grid_info.location_id=gridcoverage.id
and gridcoverage.id in (ID1, ID2, ..., IDn);
delete from gridcoverage where gridcoverage.id in (ID1, ID2, ..., IDn);
```

- 4 Delete each of the directories under /awips2/edex/data/hdf5/grid corresponding from the names obtained in step #2.



## **Chapter 17**

### **AWIPS System Monitor**

## Chapter 17. AWIPS System Monitor

### Table of Contents

	<i>Page</i>
17.1 System Monitor Overview .....	1
17.2 SCAN and FFMP Data Monitoring System .....	20
17.3 Pages and Templates .....	23
17.4 Configuration Files .....	24
17.5 Data Display Tools.....	25
17.5.1 PG Admin III.....	26
17.5.2 HDFView.....	35
17.5.3 CAVE Product Browser .....	40

### List of Exhibits

Exhibit 17.1-1. Data Set Status Symbols .....	1
Exhibit 17.1-2. AWIPS Menu – Firefox Web Browser.....	1
Exhibit 17.1-3. AWIPS System Monitor Default Main Page.....	2
Exhibit 17.1-4. AWIPS System Monitor Main Page (LDAD Monitoring) .....	3
Exhibit 17.1-6. AWIPS System Monitor Main Page (FFMP Monitoring).....	5
Exhibit 17.1-8. AWIPS System Monitor DATA: Satellite Products Status .....	7
Exhibit 17.1-9. AWIPS System Monitor DATA: Radar Products Status.....	8
Exhibit 17.1-10. AWIPS System Monitor DATA: Point Data Products Status .....	9
Exhibit 17.1-11. AWIPS System Monitor DATA: Grid Products Status.....	10
Exhibit 17.1-12. AWIPS System Monitor DATA: Redbook Products Status.....	11
Exhibit 17.1-13. AWIPS System Monitor DATA: Disk Usage Monitoring .....	12
Exhibit 17.1-14. AWIPS System Monitor DATA: CPU Utilization Monitoring.....	13
Exhibit 17.1-15. Sample CPU History Page.....	14
Exhibit 17.1-16. AWIPS System Monitor LDAD: LDAD Processes.....	15
Exhibit 17.1-17. AWIPS System Monitor LDAD: LDAD Acquisition Data.....	16
Exhibit 17.1-18. AWIPS System Monitor LDAD: LDAD Dissemination Data .....	17
Exhibit 17.1-19. AWIPS System Monitor LDAD: LDAD Disk Usage Monitoring .....	18
Exhibit 17.1-20. AWIPS System Monitor LDAD: LDAD CPU Utilization Monitoring.....	19
Exhibit 17.1-21. EXTRAS: Online Documentation and Other Sites.....	20
Exhibit 17.2-1. SCAN Data Monitoring System .....	22
Exhibit 17.2-2. FFMP Data Monitoring System.....	23
Exhibit 17.5.1-1. PG Admin III Main Window .....	27

Exhibit 17.5.1-2. PG Admin III New Server Registration Dialog .....	30
Exhibit 17.5.2-1. HDFView Main Window.....	36
Exhibit 17.5.2-4. HDFView Tableview (Spreadsheet) of Data .....	39
Exhibit 17.5.2-5. HDFView Image View of Data .....	40
Exhibit 17.5.3-1. CAVE with Product Browser Displayed .....	41
Exhibit 17.5.3-2. Satellite Product Loaded from Product Browser .....	42

### **List of Tables**

Table 17.5-1. Data Display Tools .....	26
----------------------------------------	----

## 17.1 System Monitor Overview

The AWIPS System Monitor is a software-based system used to monitor resources and performance (DATA, LDAD, SCAN, and FFMP). The monitoring software is provided separately from the other AWIPS re-host code. This allows for flexible installation options. The AWIPS System Monitor can be installed on any platform running a stand-alone or clustered instance of the AWIPS II software.

When left running, the AWIPS System Monitor automatically updates the displayed AWIPS information, indicating data set status with iconic symbols, as shown in Exhibit 17.1-1.



Exhibit 17.1-1. Data Set Status Symbols

On-time and complete data sets are flagged by a green icon on the monitor display. Late and/or incomplete data sets are flagged by a yellow or red icon, and notice is sent to the Network Control Facility (NCF). Efforts by site staff to track down and correct data delays must be closely coordinated with the NCF.

The AWIPS System Monitor uses a set of scripts to check on the timeliness of various data sets. It produces a display that can be used to track data ingest. The AWIPS System Monitor is accessed via the Internet, which is invoked from the **AWIPS** menu by selecting Firefox Web Browser as shown in Exhibit 17.1-2.



Exhibit 17.1-2. AWIPS Menu – Firefox Web Browser

The AWIPS System Monitor Default main page is shown in Exhibit 17.1-3.

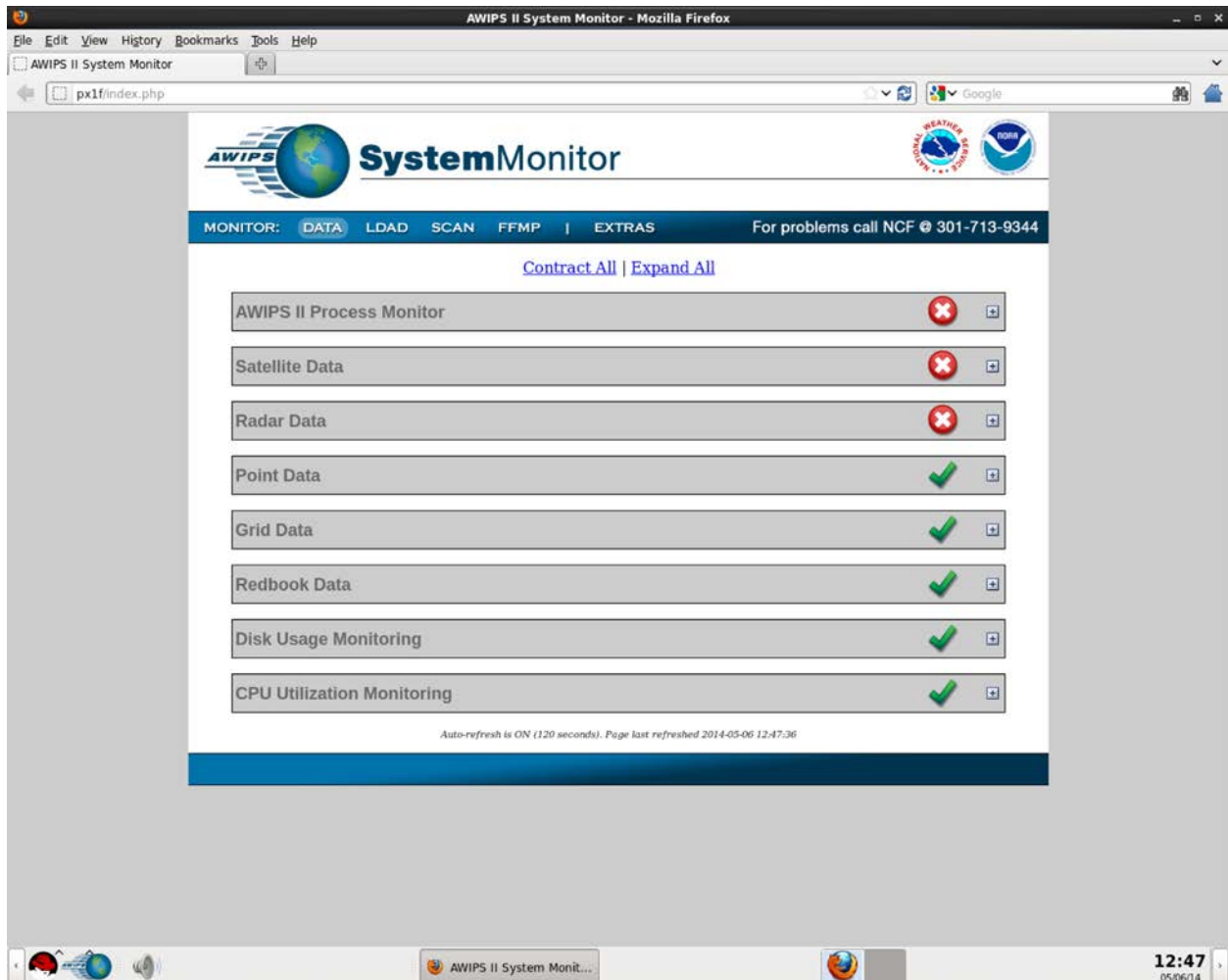

**Exhibit 17.1-3. AWIPS System Monitor Default Main Page**

The system monitor consists of two distinct components:

- Client
- Server

The client component provides the information in a Web-based format. The server component is responsible for displaying that information. The server component is the component associated with the display portion of the data monitor. It is called a server component because the files associated with it need to be installed on the machine that runs the Mozilla server, which is accessed via the Firefox Web Browser (refer to Exhibit 17.1-2). The client component comprises the files necessary to monitor the data. These files reside on each machine that the user wants to monitor.

The structure of the System Monitor is as follows:

- **System Monitor Main Page.** The System Monitor Main Page, as shown in Exhibit 17.1-3, lists the top-level statuses of the products or processes of the

DATA monitor selection. This is the default System Monitor page that initially opens when the System Monitor URL is entered.

The AWIPS II Process Monitor allows a user to quickly see what AWIPS II processes are running. The data is actually populated by the ITO agents that are running on the various servers. The monitor displays the current status of the process along with the last time it was successfully checked.

- **LDAD Monitor Selection:** The LDAD monitor selection lists the top-level statuses of the products or processes associated with LDAD, as shown in Exhibit 17.1-4.

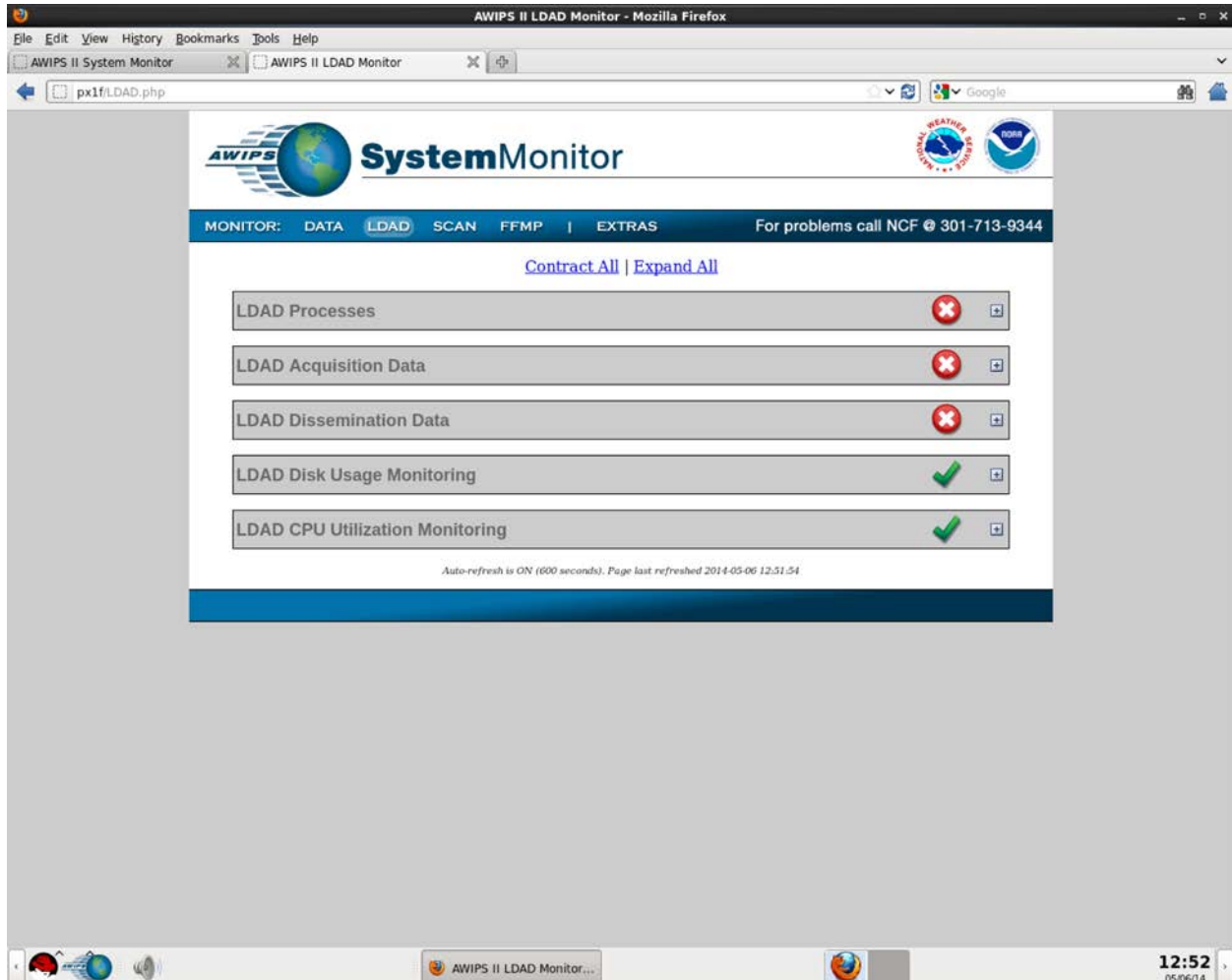

**Exhibit 17.1-4. AWIPS System Monitor Main Page (LDAD Monitoring)**

- **Other Monitor Selections:** The other monitor selections are SCAN (shown in Exhibit 17.1-5) and FFMP (shown in Exhibit 17.1-6).

**SCAN Data Monitoring System**  
This page refreshes every 2 minutes

**Lightning Data**

Most Recent Data	# Strikes - 15 mins
2014-05-06 12:56:24	0

**Model Data**

Model	Most Recent Data
RAP	2014-05-06 11:55:49
Eta	2014-05-06 09:10:04
LAPS	Not Yet Implemented

	Product:	CZ	VIL	STI	Z	MD	TVS	DMD
<b>KFTG</b> VCP:212	On RPS List?	Y	Y	Y	Y	N	Y	Y
	Latest File:	2014-05-05 19:59:03	2014-05-05 19:09:03	2014-05-05 19:59:03	2014-05-05 19:13:12	2014-05-05 12:27:21	2014-05-05 19:09:03	2014-05-05 19:13:12
<b>TDEN</b> VCP:N/A	On RPS List?	N	N	N	N	N	N	N
	Latest File:	No Data Found	No Data Found	No Data Found	No Data Found	No Data Found	No Data Found	No Data Found

Auto-refresh is ON (This page auto-updates every 120 seconds or with page refresh). Page last refreshed 2014-05-06 12:56:43

Exhibit 17.1-5. AWIPS System Monitor Main Page (SCAN Data Monitoring)

**FFMP Data Monitoring System**  
This page refreshes every 2 minutes

FFMP Plugin Status: Enabled

Reload FFMP DMS

QPE Data Sources		
QPE Data	Most Recent Data	Threshold
KFTG - DHR	2014-05-05 19:13:12	10 mins
HPE DHR MOSAIC	2014-05-06 13:03:07	15 mins
HPE Bias DHR MOSAIC	2014-05-06 13:03:08	15 mins

\* indicates a DHR source that is not on the RPS list.  
A red background indicates old data, or data that is not available (None).  
Note: For some data sources (ie: WSR-88D DHR), the 'Threshold' number of minutes used in this analysis had to be doubled, due to data times being the **beginning** of the time slice.

Non-QPE Data Sources		
Non-QPE Data	Most Recent Data	Threshold
KFTG - QPFSCAN	File Not Found	15 mins
HPE Nowcast	2014-05-06 12:42:26	15 mins
HPE Bias Nowcast	2014-05-06 12:42:26	15 mins

Exhibit 17.1-6. AWIPS System Monitor Main Page (FFMP Monitoring)

- **Individual Data Set Pages.** Individual pages are opened by clicking on any of the links located on the collapsed main page (DATA and LDAD). There is a set of links for each data type for each machine being monitored. Individual pages contain detailed listings of products and processes within each data set and their respective state.
- **DATA Products Status.** Exhibits 17.1-7 through 17.1-11 illustrate the individual pages for monitoring DATA products, and for monitoring the Disk Usage and CPU Utilization of the internal AWIPS systems.



The screenshot shows a Mozilla Firefox browser window displaying the AWIPS II System Monitor. The page header includes the AWIPS logo and 'SystemMonitor'. Below the header is a navigation bar with tabs for 'MONITOR: DATA LDAD SCAN FFMP | EXTRAS' and a contact number 'For problems call NCF @ 301-713-9344'. A sub-header for the 'AWIPS II Process Monitor' window includes links for 'Contract All | Expand All' and a note: 'Process, Disk and CPU monitoring are updated via HP ITO agents, NOT on page refresh. For CPU and disk monitoring, only when thresholds are exceeded will they be displayed here.'

Process	Host	Last Verified	Status
qpid	cpsbn2-tbw3	2014-05-05 20:14	✘
edexBridge	cpsbn2-tbw3	2014-05-05 20:14	✔
LDM Server	cpsbn2-tbw3	2014-05-05 20:08	✔
pulse (edexcluster IP)	cpsbn2-tbw3	2014-05-05 20:08	✔
Postgres Database	dx1-tbw3	2014-05-06 12:45	✔
pypies Server	dx2-tbw3	2014-05-06 12:45	✔
ingest	dx3-tbw3	2014-05-06 12:42	✔
ingestDat	dx3-tbw3	2014-05-06 12:42	✔
ingestGrib	dx3-tbw3	2014-05-06 12:42	✔
request	dx3-tbw3	2014-05-06 12:42	✔
ingest	dx4-tbw3	2014-05-06 12:42	✔
ingestDat	dx4-tbw3	2014-05-06 12:42	✔
ingestGrib	dx4-tbw3	2014-05-06 12:42	✔
request	dx4-tbw3	2014-05-06 12:42	✔

The bottom of the browser window shows the system tray with the time '12:48' and date '05/06/14'.

Exhibit 17.1-7. AWIPS System Monitor Data: AWIPS II Process Monitor

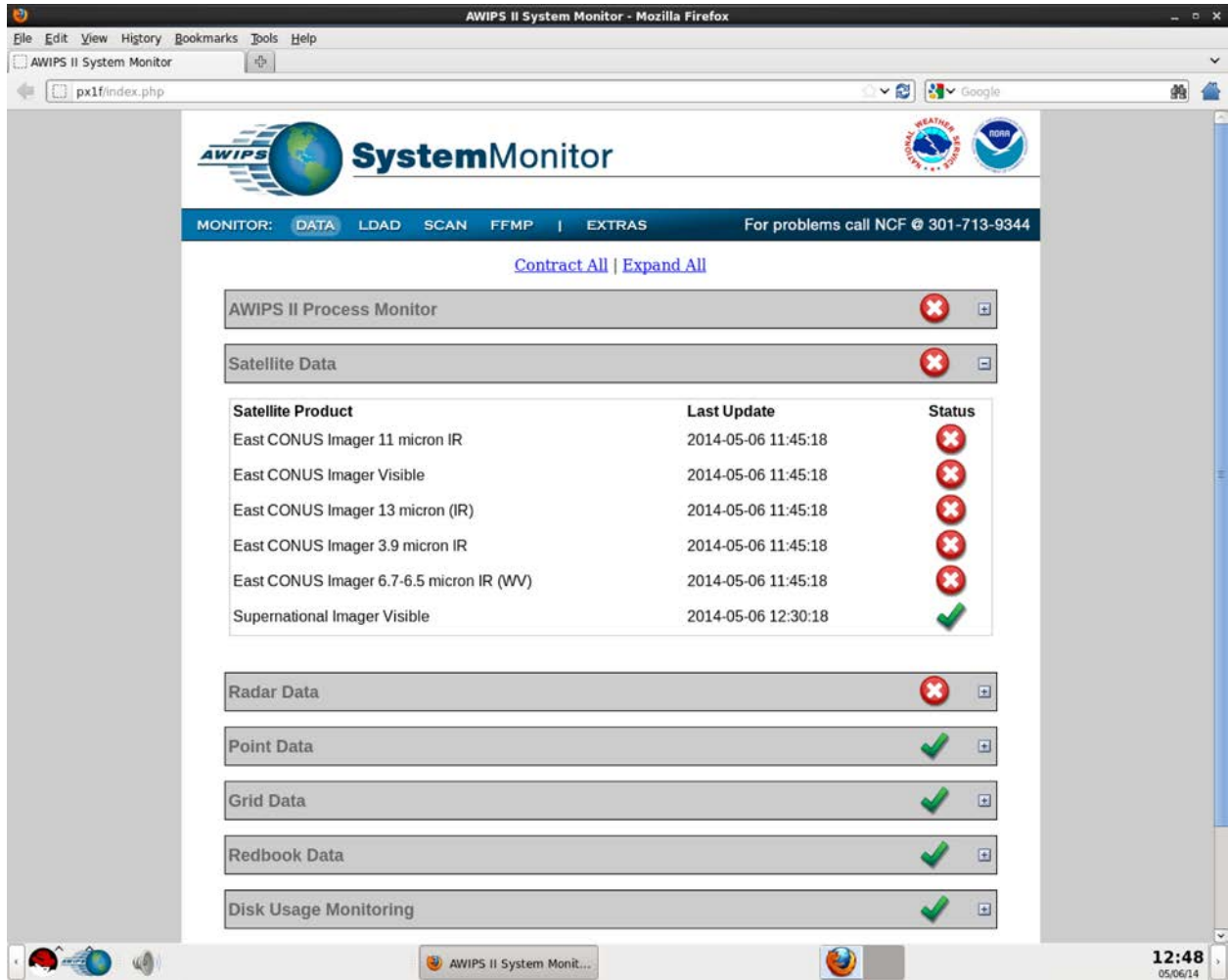

**Exhibit 17.1-8. AWIPS System Monitor DATA: Satellite Products Status**

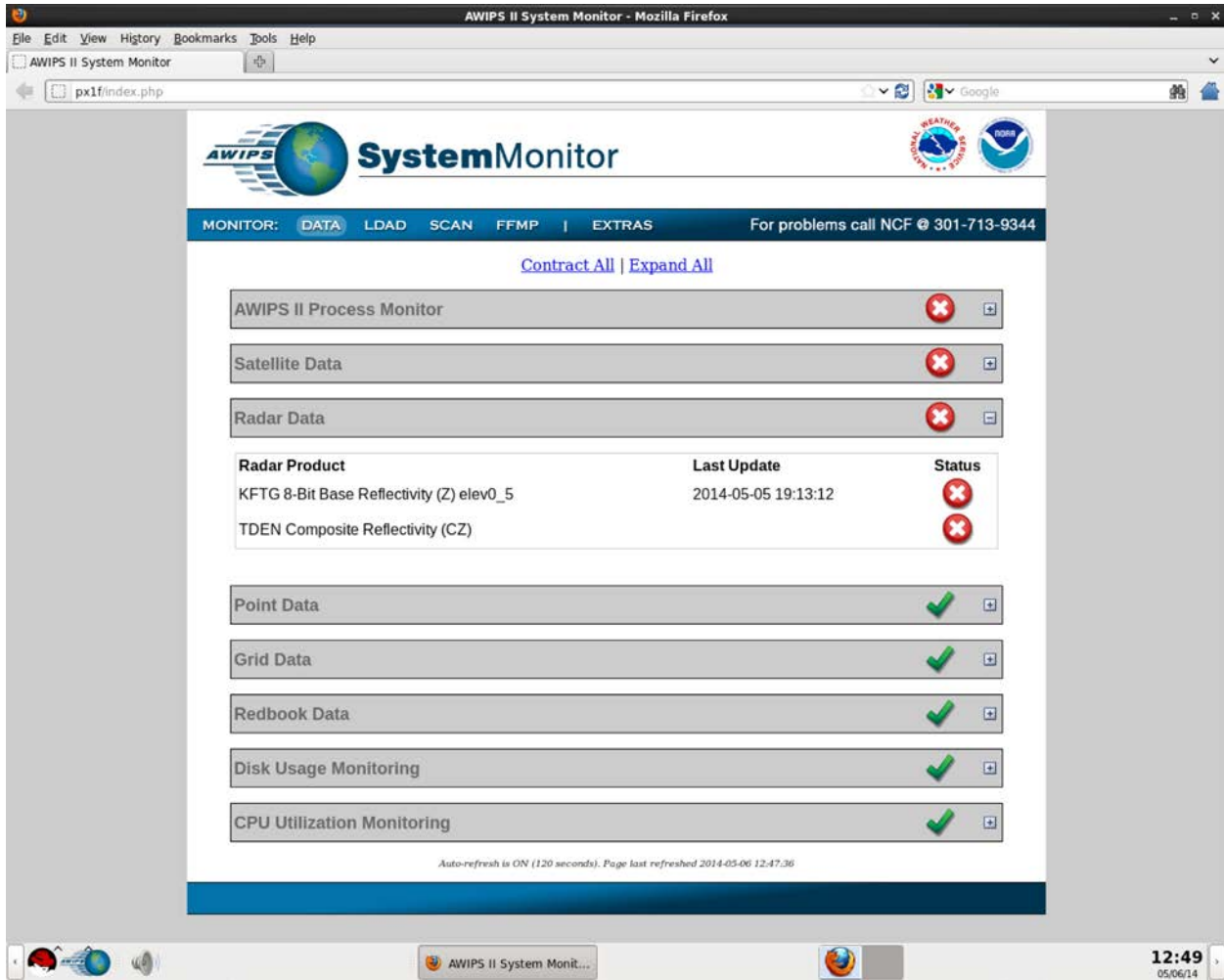

**Exhibit 17.1-9. AWIPS System Monitor DATA: Radar Products Status**

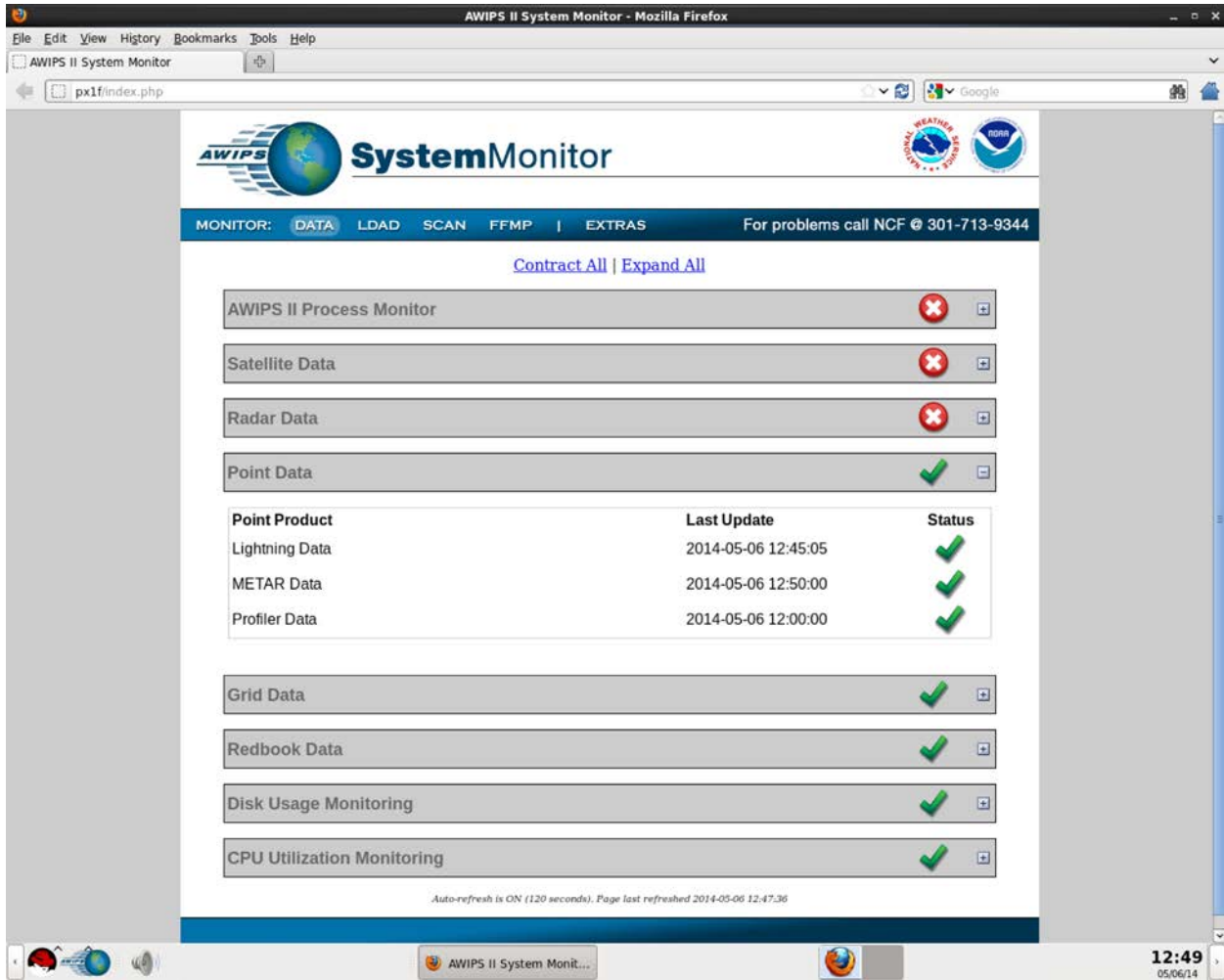

**Exhibit 17.1-10. AWIPS System Monitor DATA: Point Data Products Status**

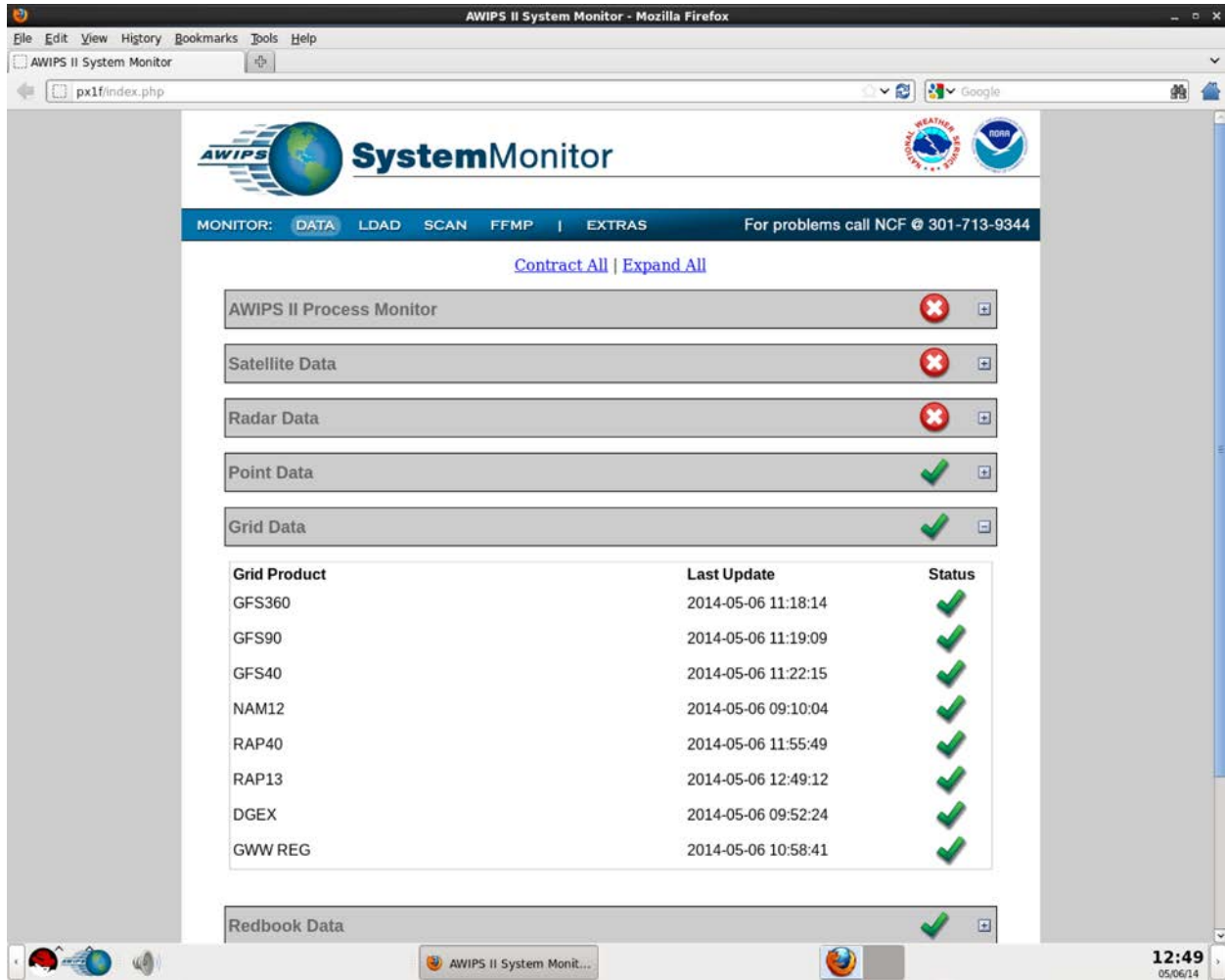

**Exhibit 17.1-11. AWIPS System Monitor DATA: Grid Products Status**

The screenshot shows the AWIPS II System Monitor web interface. The browser title is "AWIPS II System Monitor - Mozilla Firefox". The address bar shows "px1f/index.php". The page header includes the AWIPS logo and "SystemMonitor". The navigation menu has "DATA" selected. Below the menu, there are several monitoring components:

- AWIPS II Process Monitor (Status: X)
- Satellite Data (Status: X)
- Radar Data (Status: X)
- Point Data (Status: ✓)
- Grid Data (Status: ✓)
- Redbook Data (Status: ✓)
- Redbook Product table:

Redbook Product	Last Update	Status
Redbook Graphics	2014-05-06 12:49:15	✓

- Disk Usage Monitoring (Status: ✓)
- CPU Utilization Monitoring (Status: ✓)

Auto-refresh is ON (120 seconds). Page last refreshed 2014-05-06 12:49:36.

**Exhibit 17.1-12. AWIPS System Monitor DATA: Redbook Products Status**

**Disk Usage Monitoring and CPU Utilization Monitoring** are updated via HP ITO agents. These two options, which are shown in Exhibits 17.1-13 and 17.1-14, show disk and CPU checks against all internal AWIPS systems.

**“Click here to display CPU Usage for the system”**

This will execute the script `/awips/fxa/bin/showCPU.sh` and redirect the user to a new page. While executing, it will display the following message “Attempting to launch the CPU monitor on \$ipAddress” where \$ipAddress is the IP address of the machine launching the script. A sample CPU history is shown in Exhibit 17.1-15.

**NOTE:** The showCPU.sh script can only be executed on a valid LX or XT workstation on the same subnet as the local LAN.

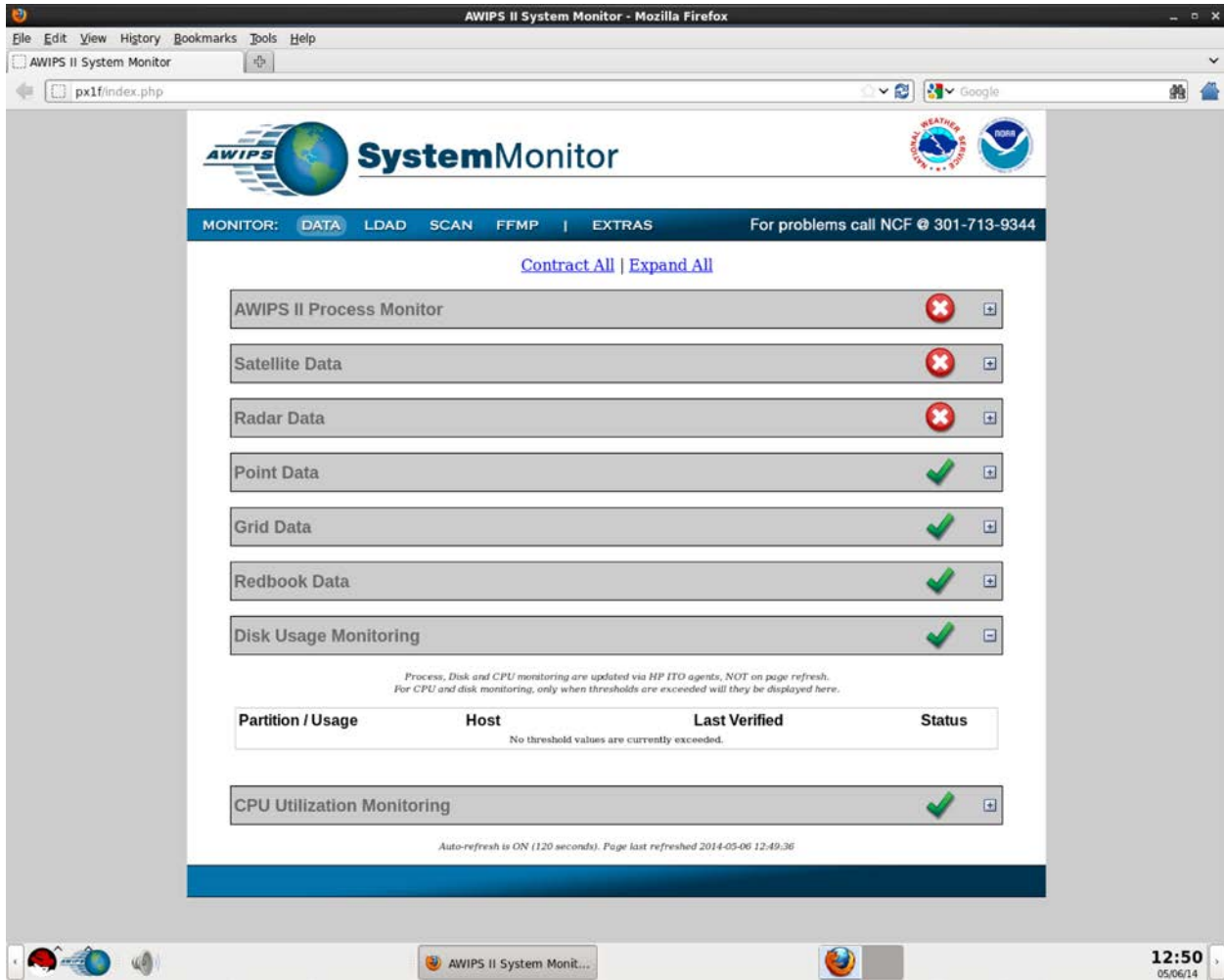

Exhibit 17.1-13. AWIPS System Monitor DATA: Disk Usage Monitoring

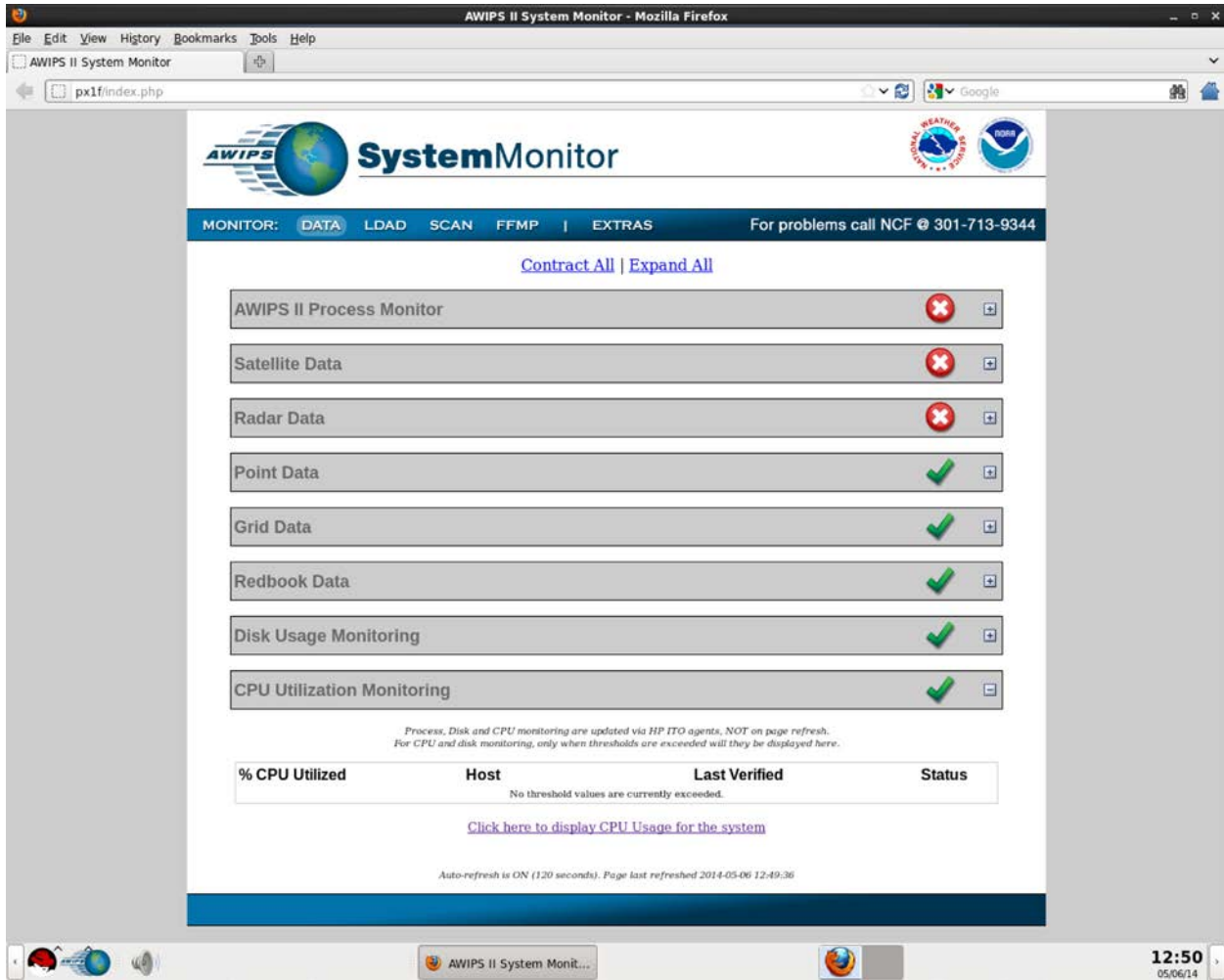

Exhibit 17.1-14. AWIPS System Monitor DATA: CPU Utilization Monitoring



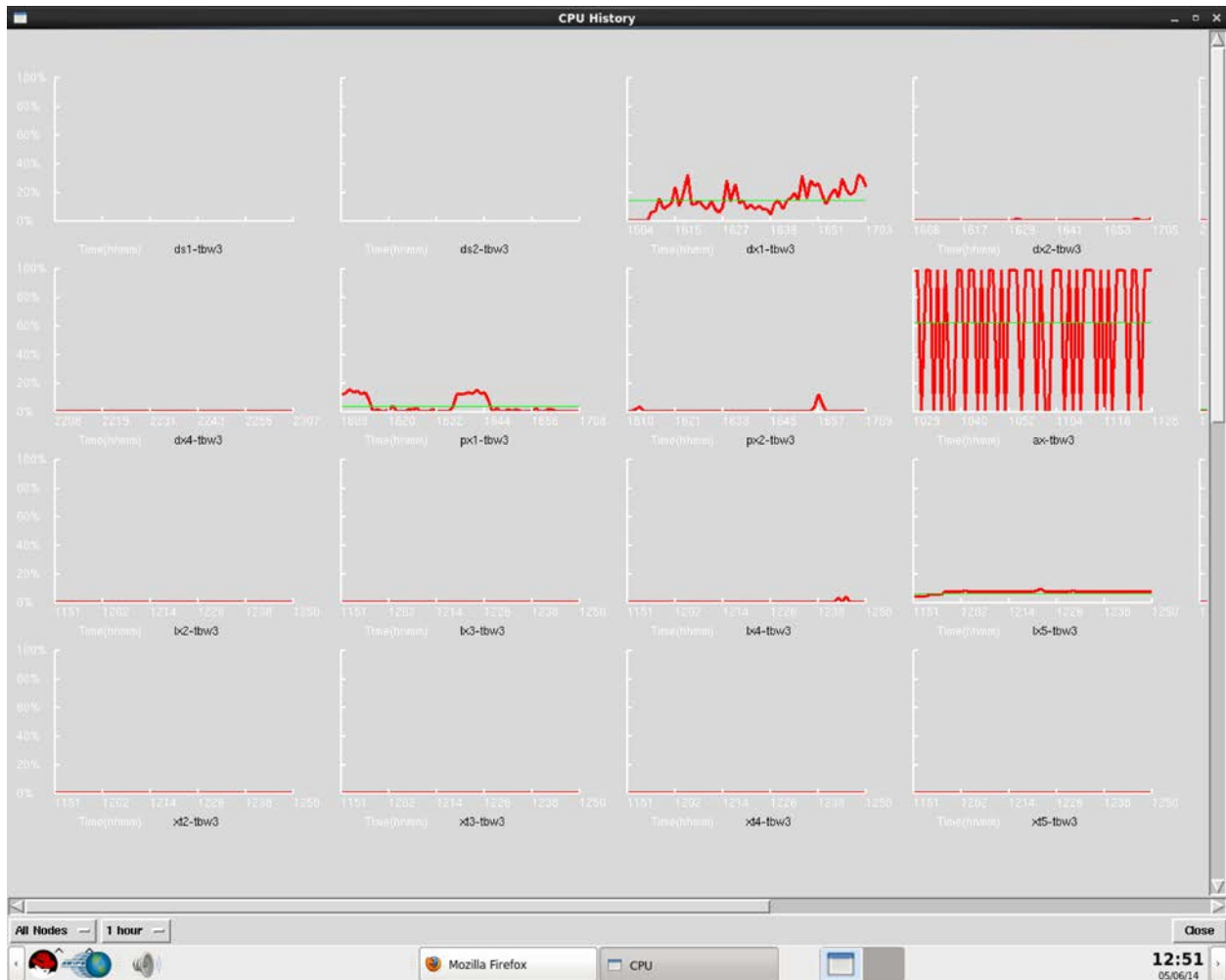

Exhibit 17.1-15. Sample CPU History Page

- **LDAD Processes and Products Status.** Exhibits 17.1-16 – 17.1-18 illustrate the individual pages for monitoring LDAD Processes and Products.

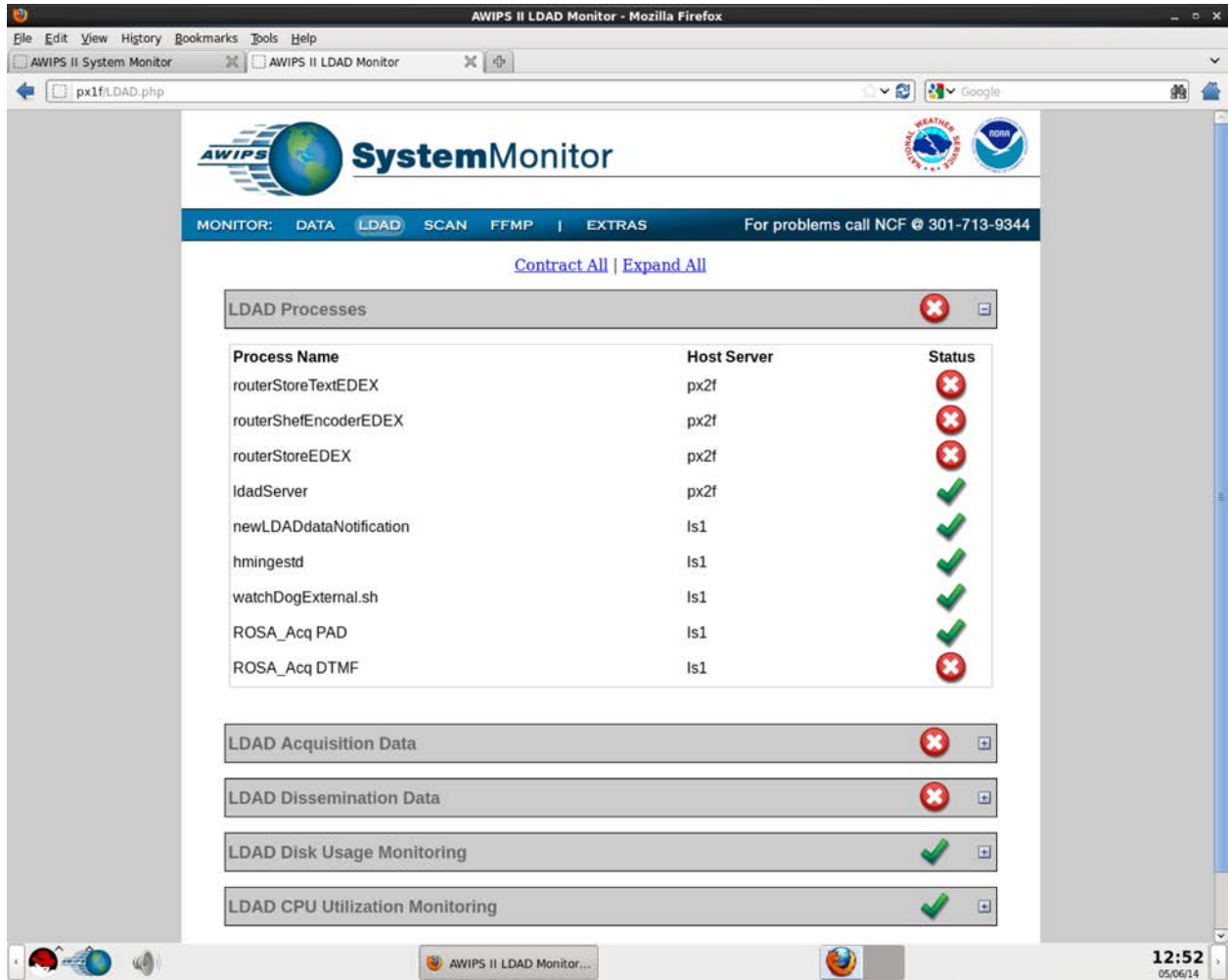

Exhibit 17.1-16. AWIPS System Monitor LDAD: LDAD Processes

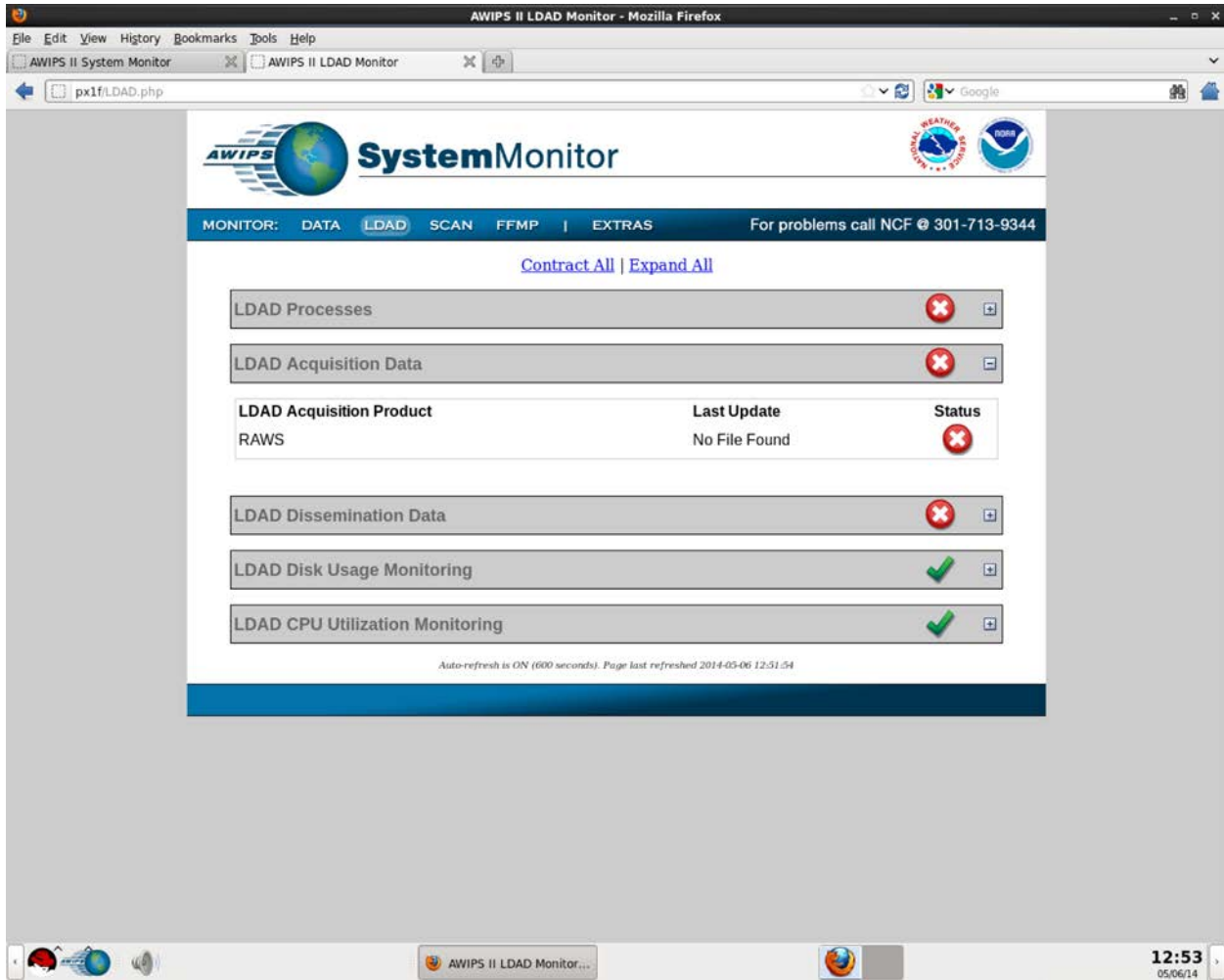

Exhibit 17.1-17. AWIPS System Monitor LDAD: LDAD Acquisition Data

The screenshot shows the AWIPS System Monitor web interface. The browser window title is "AWIPS II LDAD Monitor - Mozilla Firefox". The address bar shows "px1f/LDAD.php". The page header includes the AWIPS logo and "SystemMonitor". The navigation menu has "LDAD" selected. Below the menu, there are links for "Contract All" and "Expand All". The main content area displays a list of monitoring items:

Item	Status
LDAD Processes	✖
LDAD Acquisition Data	✖
LDAD Dissemination Data	✖
<b>LDAD Dissemination Product</b>	<b>Last Update</b>
DEN Special Weather Statement	No File Found
	✖
LDAD Disk Usage Monitoring	✔
LDAD CPU Utilization Monitoring	✔

At the bottom of the page, it says "Auto-refresh is ON (600 seconds). Page last refreshed 2014-05-06 12:51:54". The system tray at the bottom shows the time "12:53" and date "05/06/14".

**Exhibit 17.1-18. AWIPS System Monitor LDAD: LDAD Dissemination Data**

LDAD Disk Usage Monitoring and LDAD CPU utilization monitoring are updated via HP ITO agents. The label was changed on the LDAD page to be consistent with the rest of the page. In prior versions of the system monitor, the “data” page showed disk and CPU checks against all internal AWIPS systems, whereas the LDAD page showed only checks against the LDAD servers.

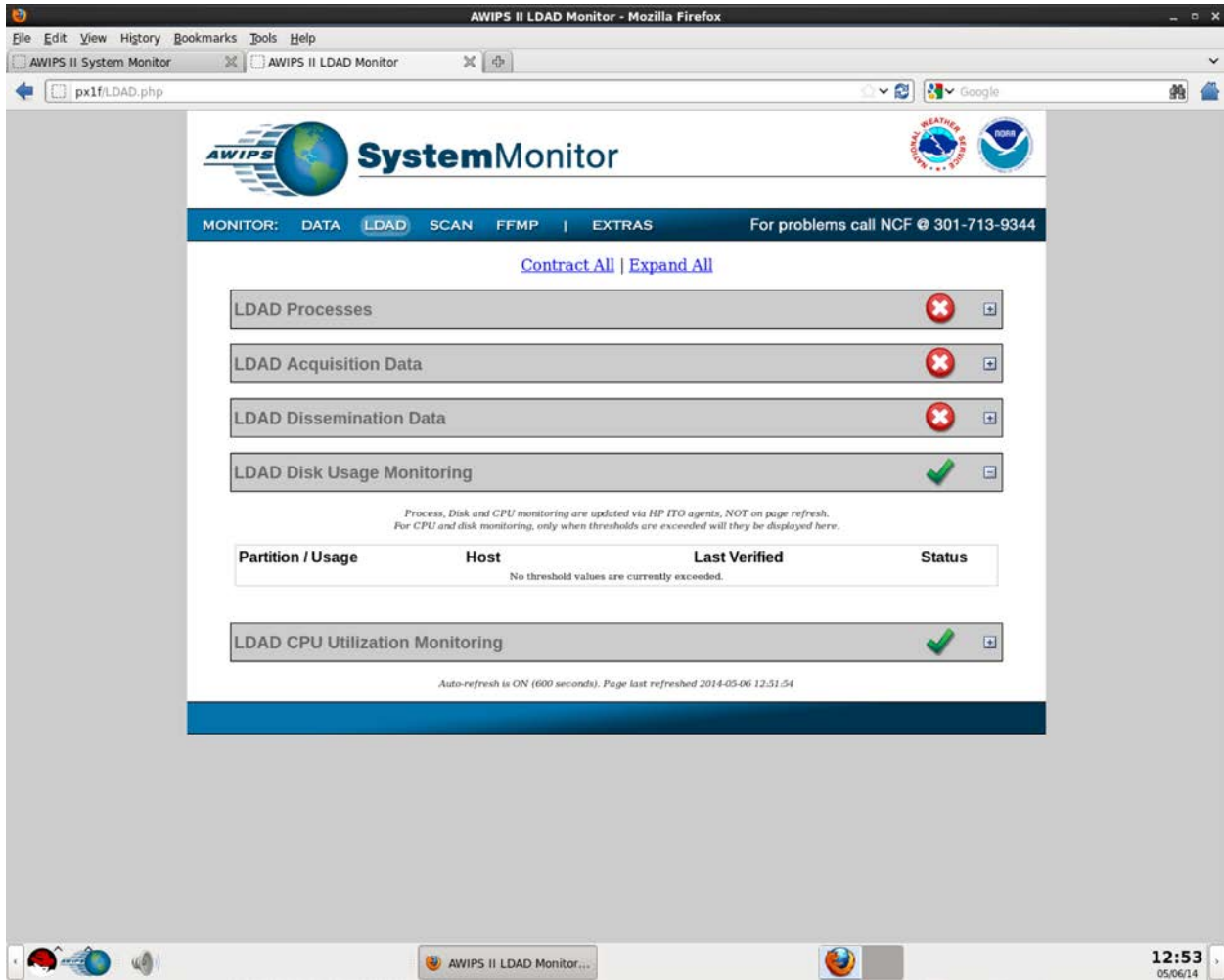

Exhibit 17.1-19. AWIPS System Monitor LDAD: LDAD Disk Usage Monitoring

The screenshot displays the AWIPS System Monitor web interface in a Mozilla Firefox browser window. The page title is "AWIPS II LDAD Monitor - Mozilla Firefox". The browser address bar shows "px1f/LDAD.php". The interface features a navigation menu with "MONITOR:", "DATA", "LDAD", "SCAN", "FFMP", and "EXTRAS". A contact number "For problems call NCF @ 301-713-9344" is visible. Below the menu, there are links for "Contract All" and "Expand All". A list of monitoring components is shown with status indicators:

- LDAD Processes: Red X icon
- LDAD Acquisition Data: Red X icon
- LDAD Dissemination Data: Red X icon
- LDAD Disk Usage Monitoring: Green checkmark icon
- LDAD CPU Utilization Monitoring: Green checkmark icon

Below the list, a note states: "Process, Disk and CPU monitoring are updated via HP ITO agents, NOT on page refresh. For CPU and disk monitoring, only when thresholds are exceeded will they be displayed here." A table with the following structure is present:

% CPU Utilized	Host	Last Verified	Status
No threshold values are currently exceeded.			

At the bottom of the table area, it says "Auto-refresh is ON (600 seconds). Page last refreshed 2014-05-06 12:51:54". The system tray at the bottom right shows the time "12:54" and date "05/06/14".

**Exhibit 17.1-20. AWIPS System Monitor LDAD: LDAD CPU Utilization Monitoring**

- **EXTRAS:** Provides link for Online Documentation for the User's Guide and AWIPS System Manager's Manual is available as shown in Exhibit 17.1-21.

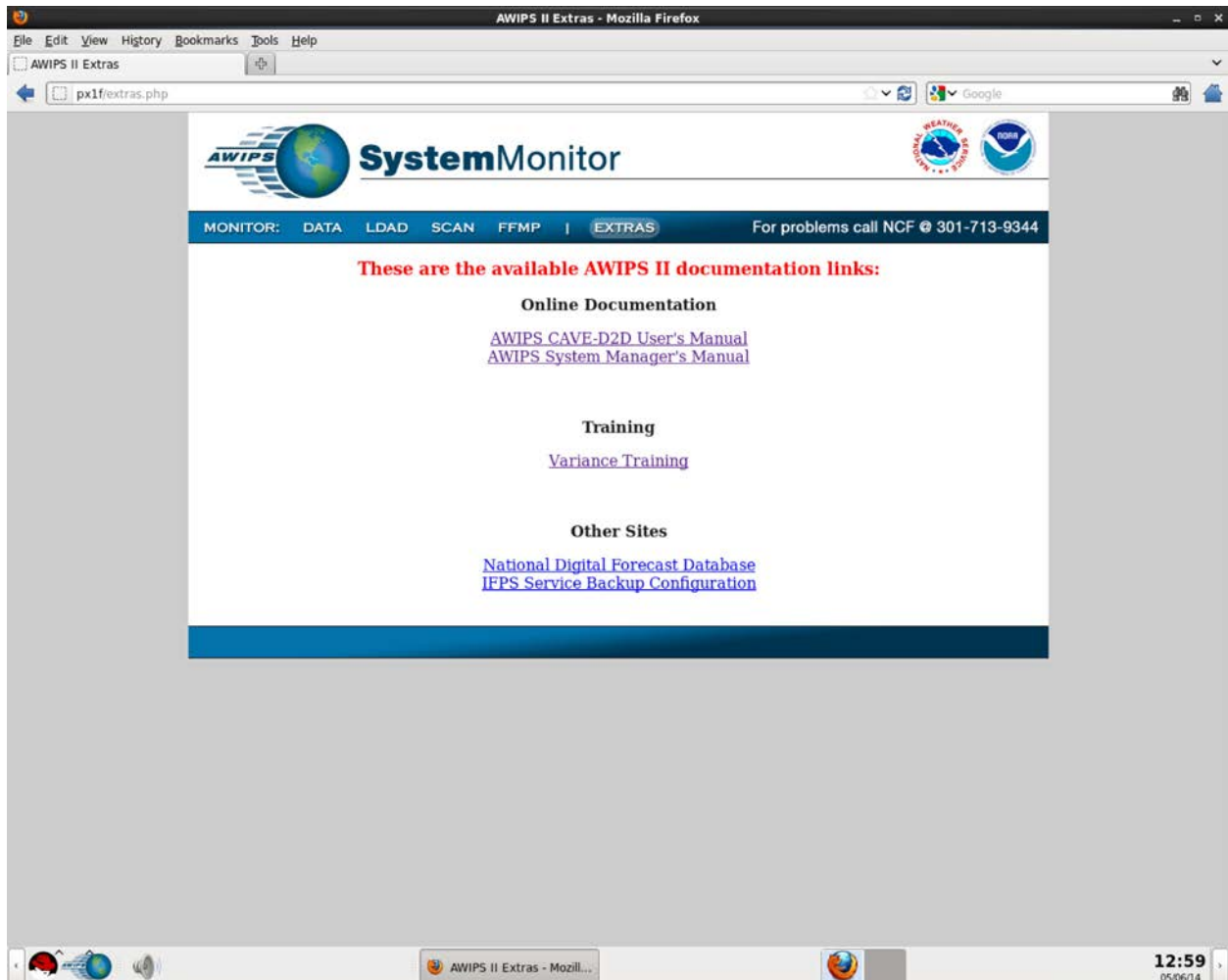

Exhibit 17.1-21. EXTRAS: Online Documentation and Other Sites

## 17.2 SCAN and FFMP Data Monitoring System

The SCAN\_DMS and FFMP\_DMS have been incorporated into the AWIPS II System Monitor, as shown in Exhibits 17.1-5 and 17.1-6. Detailed information for these two monitored systems follows.

The information loaded on the page occurs on page-load or refresh. Depending on the amount of data being kept in the data store and the number of SCAN radars in use, the page load can vary between 5 and 15 seconds. The legacy SCAN\_DMS loads blank and requires the user to click on a button to run an external script.

The default `/data/fxa/A2_SysMonitor/config/scan_radar.xml` ships with an Omaha localization.

Replace the `<rda>` tags with the RDA name of the SCAN-enabled radars. An identical configuration exists for the FFMP DMS page named `ffmp_radar.xml`.

```
<radar>
  <data>
    <rda>KOAX</rda>
    <errorthresh>600</errorthresh>
  </data>

  <data>
    <rda>KUEX</rda>
    <errorthresh>600</errorthresh>
  </data>
  <data>
    <rda>KDMX</rda>
    <errorthresh>600</errorthresh>
  </data>
</radar>
```

The FFMP Data Monitoring System (DMS) contains a second configuration file for the RFC grids named **ffmp\_grids.xml**.

**Note:** The `ffmpPurgeRules.xml` should not allow USER or Workstation overrides.

The default installation ships with all the RFC grids being monitored and can be trimmed as needed by each site.

The grid monitoring on the SCAN DMS page is controlled inside the `SCAN.php` template. As on the Data Monitor, simple SQL queries are executed against the metadata database. Lightning strikes are obtained by executing a uEngine script named **bltool.py**, which queries the HDF5 and sums up the past 15 minutes' worth of lightning data. See Exhibit 17.2-1.



**SCAN Data Monitoring System**  
This page refreshes every 2 minutes

**Lightning Data**

Most Recent Data	# Strikes - 15 mins
2014-05-06 12:56:24	0

**Model Data**

Model	Most Recent Data
RAP	2014-05-06 11:55:49
Eta	2014-05-06 09:10:04
LAPS	Not Yet Implemented

Product	CZ	VIL	STI	Z	MD	TVS	DMD
<b>KFTG</b> VCP:212	Y	Y	Y	Y	N	Y	Y
On RPS List?							
Latest File:	2014-05-05 19:09:03	2014-05-05 19:09:03	2014-05-05 19:09:03	2014-05-05 19:13:12	2014-05-05 12:27:21	2014-05-05 19:09:03	2014-05-05 19:13:12
<b>TDEN</b> VCP:N/A	N	N	N	N	N	N	N
On RPS List?							
Latest File:	No Data Found	No Data Found	No Data Found	No Data Found	No Data Found	No Data Found	No Data Found

Auto-refresh is ON (This page auto-updates every 120 seconds or with page refresh). Page last refreshed 2014-05-06 12:56:43

Exhibit 17.2-1. SCAN Data Monitoring System

The FFMP monitor also displays the status of the `ffmp_plugin` (below the DAT logo). It monitors only the primary EDEX server as defined in the `params.xml` file. See Exhibit 17.2-2.

**FFMP Data Monitoring System**  
This page refreshes every 2 minutes

FFMP Plugin Status: Enabled

Reload FFMP DMS

QPE Data Sources		
QPE Data	Most Recent Data	Threshold
KFTG - DHR	2014-05-05 19:13:12	10 mins
HPE DHR MOSAIC	2014-05-06 13:03:07	15 mins
HPE Bias DHR MOSAIC	2014-05-06 13:03:08	15 mins

\* indicates a DHR source that is not on the RPS list.  
A red background indicates old data, or data that is not available (None).  
Note: For some data sources (ie: WSR-88D DHR), the 'Threshold' number of minutes used in this analysis had to be doubled, due to data times being the **beginning** of the time slice.

Non-QPE Data Sources		
Non-QPE Data	Most Recent Data	Threshold
KFTG - QPFSCAN	File Not Found	15 mins
HPE Nowcast	2014-05-06 12:42:26	15 mins
HPE Bias Nowcast	2014-05-06 12:42:26	15 mins

ffmp\_radar.xml

ffmp\_grids.xml

AWIPS II FFMP Monitor ...

12:58  
05/06/14

Exhibit 17.2-2. FFMP Data Monitoring System

### 17.3 Pages and Templates

The Apache directory is `/etc/httpd/conf`. Any pre-existing configuration inside this location on the px1 is not baseline. The existing `httpd.conf` will be saved before installation and renamed `AWIPS1-httpd.conf`. This is the apache server configuration, which rarely needs to be deviated from the national baseline.

The installation directory for the AWIPS II System Monitor is: `/data/fxa/A2_SysMonitor` and all configuration, scripts, and page templates are installed here.

The main php page templates are in the top-level directory and are:

<code>index.php</code>	default page loaded when browsing <a href="http://px1f">http://px1f</a>
<code>LDAD.php</code>	LDAD System Monitor loaded when browsing <a href="http://px1f/LDAD.php">http://px1f/LDAD.php</a>

SCAN.php      SCAN DMS loaded when browsing http://px1f/SCAN.php  
 FFMP.php      FFMP DMS loaded when browsing http://px1f/FFMP.php

All actions performed on page load, such as SQL queries to the metadata database, are contained inside these page template files.

There is no persistent process running and sending information to the AWIPS II System Monitor. All database queries and scripts are run on page load, refresh, or after refresh threshold is lapsed. The exceptions are the CPU and disk monitoring sections, which run via cronjob.

There are 4 root cronjobs that run to monitor the disk and cpu statistics. These crons are in /etc/ha.d/cron.d/a2px1cron and run on the server running the a2px1apps package, default PX1. The crons populate the Disk Monitor and CPU Monitor sections of the System and LDAD Monitor pages.

```
# cron to update disk monitor portion of AWIPS II System Monitor
*/20 * * * * /data/fxa/A2_SysMonitor/scripts/diskMon.sh >> /dev/null
*/20 * * * * /data/fxa/A2_SysMonitor/scripts/ldad_diskMon.sh >> /dev/null

# cron to update CPU monitor portion of AWIPS II System Monitor
*/20 * * * * /data/fxa/A2_SysMonitor/scripts/cpuMon.sh >> /dev/null
*/20 * * * * /data/fxa/A2_SysMonitor/scripts/ldad_cpuMon.sh >> /dev/null
```

**Note:** The AWIPS II rehost script will configure the heartbeat and cron appropriately. If the rehost script is not run, a manual insert of the above 4 cronjobs is required. In order to make the AWIPS II System Monitor highly available without running the rehost script, simply add the httpd (apache service) to /etc/ha.d/resource.d/a2px1apps.

## 17.4 Configuration Files

The configuration files are contained in /data/fxa/A2\_SysMonitor/config

The environment configuration is contained in **params.xml**

<b>/data/fxa/A2_SysMonitor//config/params.xml</b>	
<pre>&lt;params&gt; &lt;config&gt; &lt;dbserver&gt;dx1&lt;/dbserver&gt; &lt;primary_edex&gt;dx3&lt;/primary_edex&gt; &lt;client_edex&gt;dx4&lt;/client_edex&gt; &lt;dbuser&gt;awips&lt;/dbuser&gt; &lt;dbpass&gt;awips&lt;/dbpass&gt; &lt;refresh&gt;120&lt;/refresh&gt; &lt;ldad_refresh&gt;600&lt;/ldad_refresh&gt; &lt;scan_refresh&gt;120&lt;/scan_refresh&gt; &lt;ffmp_refresh&gt;120&lt;/ffmp_refresh&gt; &lt;edex_home&gt;/awips2/edex&lt;/edex_home&gt; &lt;common_base&gt;/data/utility/common_static/base&lt;/common_base&gt; &lt;monitor_plugin&gt;/monitoring/MonitorPluginState.xml&lt;/monitor_plugin&gt; &lt;/config&gt; &lt;/params&gt;</pre>	<p>The values entered to the left are default and as shipped. Should the baseline system architecture change, these values may need to be changed as well to reflect such.</p> <p>The &lt;refresh&gt; options are for the PHP template pages and are in seconds.</p>

The configuration for the various products monitored are contained in this directory.

<b>/data/fxa/A2_SysMonitor/config</b>	
satellite.xml radar.xml point.xml grid.xml graphic.xml ldad.xml  ffmp_grids.xml  scan_radar.xml  ffmp_radar.xml	<p>The SQL commands execute on page load or refresh and are contained in these files and under the tag &lt;sqltext&gt;. The warning and error threshold for each data type is also contained therein, defined by &lt;warnthresh&gt; and &lt;errorthresh&gt;. The name to display in the monitor is defined by the &lt;productname&gt; tag.</p> <p>The ffmp_grids.xml contains the configuration for the RFC grids while the ffmp_radar.xml contains the configuration for the radars.</p> <p>scan_radar.xml contains the radars for which SCAN is applicable.</p> <p>To add products or radars to any of these configuration files, simply copy a pre-existing XML tag and change the appropriate variables, e.g., &lt;rda&gt;.</p>

### 17.5 Data Display Tools

Several tools are available for data display/system monitoring. This section introduces three useful tools: PG Admin III; HDFView; and CAVE Product Browser. Table 17.5-1 provides a brief description of each tool.

**Table 17.5-1. Data Display Tools**

Tool	Description
PG Admin III	PG Admin III is a PostgreSQL-specific database administration tool. PG Admin III provides a graphical user interface (GUI)-based interface to the database and allows the user to view data and run SQL commands. PG Admin III is part of the existing AWIPS toolset.
HDFView	HDFView is a GUI-based tool that provides an Explorer-style interface into the contents of an HDF5 file. HDFView is part of the AWIPS toolset.
CAVE Product Browser	The CAVE Product Browser is part of CAVE, the AWIPS II visualization environment. Used in conjunction with the CAVE D2D perspective, it provides access to displayable data and other products available in AWIPS II.

### 17.5.1 PG Admin III

PG Admin III is part of the existing AWIPS toolset. In the current architecture, it is installed in `/usr/local/pgadmin3` and is accessible from AWIPS LX and XT workstations. PG Admin III provides a GUI interface to a PostgreSQL database.

To run PG Admin II, you will need to:

1. Log on to an LX or XT workstation.
2. Open a terminal window.
3. There are two versions of `pgadmin3`, one for AWIPS I and one for AWIPS II. The AWIPS II version is in `/awips2/pgadmin3/bin/`.

In the terminal window, change directory to **`/awips2/pgadmin3/bin/`**.

4. In the terminal window, enter: **`./pgadmin3 &`**.

```
na2-ntca{rschup}103: ll /usr/local/pgadmin3
lrwxrwxrwx 1 root root 14 Jan 14 2011 /usr/local/pgadmin3 -> pgadmin3-1.8.4/

na2-ntca{rschup}104: cd /awips2/pgadmin3/bin/

na2-ntca{rschup}105: ls
pgadmin3  pgagent
```

Set up `.tcshrc` to allow easy command line execution. Set up `.pgpass` to avoid being prompted for the *postgres* “awips” password.

```
na2-ntca{rschup}101: ll /usr/bin/csh
lrwxrwxrwx. 1 root root 9 May 12 2014 /usr/bin/csh -> /bin/tcsh

na2-ntca{rschup}101: cat .tcshrc
# .cshrc generated by setupAwipsUser.sh
setenv FXA_HOME /awips/fxa
source $FXA_HOME/.cshrc
setenv PRINTER lp1
# end lines generated by setupAwipsUser.sh
alias hdfview /awips2/tools/bin/hdf-java/HDF_GROUP/HDFView/2.10.1/bin/hdfview.sh
alias pgadmin3 /awips2/pgadmin3/bin/pgadmin3

na2-ntca{rschup}101: cat .pgpass
dx1f:5432*:awips:
```

Execute pgadmin3 in background mode at the command line to display PG Admin III's main window as shown in Exhibit 17.5.1-1.

```
na2-ntca{rschup}110: pgadmin3&
```

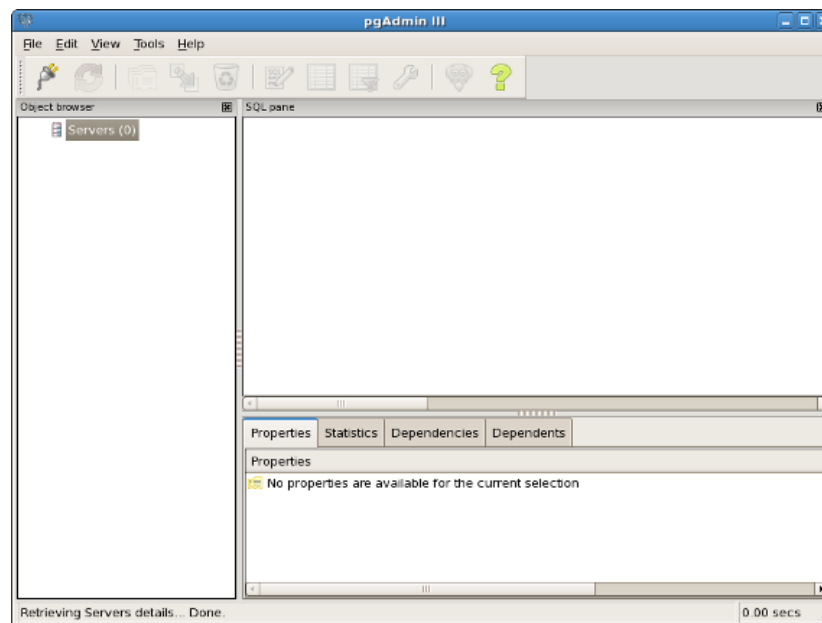

Exhibit 17.5.1-1. PG Admin III Main Window

The rpm command outputs are shown below.

```
[awildman@lx2-jax bin]$ rpm -qiv pgadmin3
```

```
Name           : pgadmin3                      Relocations: /usr/local
Version        : 1.8.4                          Vendor: NOAA/AWIPS
Release       : 1.AWIPS.OB9211                  Build Date: Tue 10 Aug 2010
              06:27:23 PM GMT
Install Date: Thu 04 Dec 2014 02:58:18 PM GMT    Build Host:
              frosty.nws.noaa.gov
Group         : AWIPS/Freeware                  Source RPM: pgadmin3-1.8.4-
              1.AWIPS.OB9211.src.rpm
Size          : 146566390                       License: GPL
Signature     : (none)
Packager      : Brian Graham (Raytheon/SMS)
URL           : http://www.pgadmin.org
Summary      : pgadmin3 for AWIPS OB9211 - RHEL5u5
```

```
Description :
```

```
pgAdmin III is the most popular and feature rich Open Source
administration and development platform for PostgreSQL, designed
to answer the needs of all users, from writing simple SQL queries
to developing complex databases. The graphical interface supports
all PostgreSQL features and makes administration easy. The
application also includes a syntax highlighting SQL editor, a
server-side code editor, an SQL/batch/shell job scheduling agent,
support for the Slony-I replication engine and much more. Server
connection may be made using TCP/IP or Unix Domain Sockets (on
*nix platforms), and may be SSL encrypted for security.
```

```
[awildman@lx2-jax WarnGen]$ rpm -q --whatprovides /usr/lib64/libxslt.so.1
libxslt-1.1.26-2.el6_3.1.x86_64
```

```
[awildman@lx2-jax WarnGen]$ rpm -qR pgadmin3
```

```
/bin/sh
/bin/sh
/bin/sh
/bin/sh
rpmlib(PayloadFilesHavePrefix) <= 4.0-1
rpmlib(CompressedFileNames) <= 3.0.4-1
[awildman@lx2-jax WarnGen]$ rpm -q --requires pgadmin3
/bin/sh
/bin/sh
/bin/sh
/bin/sh
rpmlib(PayloadFilesHavePrefix) <= 4.0-1
rpmlib(CompressedFileNames) <= 3.0.4-1

[awildman@lx2-jax WarnGen]$ rpm -q --whatprovides /usr/local/pgadmin3
pgadmin3-1.8.4-1.AWIPS.OB9211.i686

[awildman@lx2-jax WarnGen]$ rpm -q --whatprovides /awips2/pgadmin3
awips2-pgadmin3-1.16.1-1.e16.x86_64
```

The first time PG Admin is used with the AWIPS II databases, you will need to set up a connection to the database. The connection is established using the *New Server Registration* dialog (shown in Exhibit 17.5.1-2). The *New Server Registration* dialog is accessed via the “connection to server” button () on the PG Admin III toolbar.



The screenshot shows a 'New Server Registration' dialog box with the following fields and values:

- Name: AWIPS 2
- Host: dx1f
- Port: 5432
- SSL: (dropdown menu)
- Maintenance DB: metadata
- Username: awips
- Password: (empty)
- Store password:
- Restore env?:
- DB restriction: (empty)
- Service: (empty)
- Connect now:

Buttons at the bottom: Help, OK, Cancel.

**Exhibit 17.5.1-2. PG Admin III New Server Registration Dialog**

When you register a new server, you need to provide four values:

1. The name of the database – This can be anything you want but it should be something meaningful such as “AWIPS II Database.”
2. The name of the host system – For AWIPS II, the host system is *dx1f*.
3. The database to connect to – must be valid, such as *metadata*.
4. The username – For AWIPS II, the correct Postgres user name is *awips*. This is not the **awips** login account, it is a user name specified in the Postgres database. There is no correlation to the *awips* account in */etc/passwd*.

Navigate to the desired table by following the directory tree on the left and opening the tabs “Server/Databases/metadata/Schemas/awips/Tables” as shown in Exhibit 17.5.1-3.

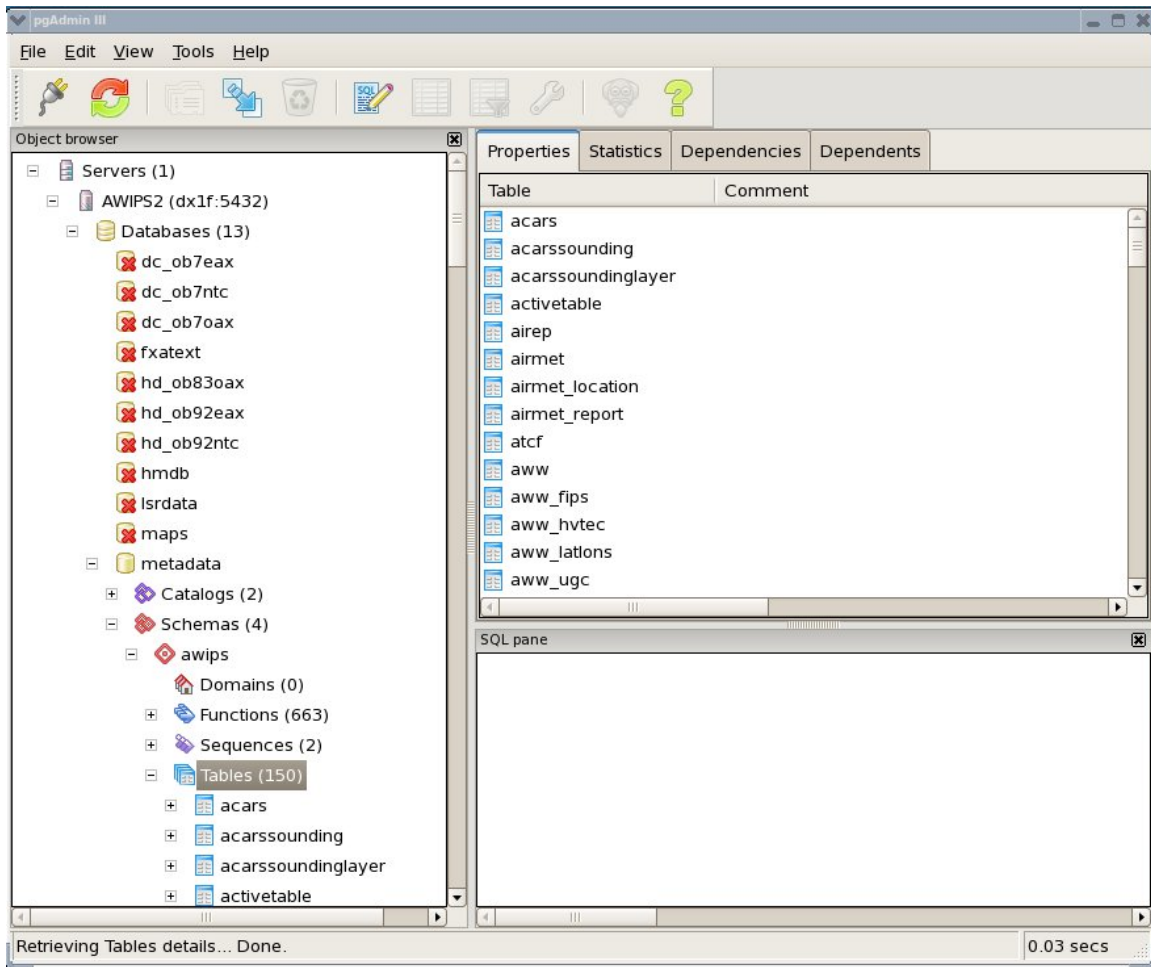

**Exhibit 17.5.1-3 - Server/Databases/metadata/Schemas/awips/Tables**

To use PG Admin to view data, locate the desired table in the tree view on the left side of the main window and click the ‘view data’ button (  ) on the toolbar as shown below.. The table will display in the *Edit Data* window as shown in Exhibit 17.5.1-4.

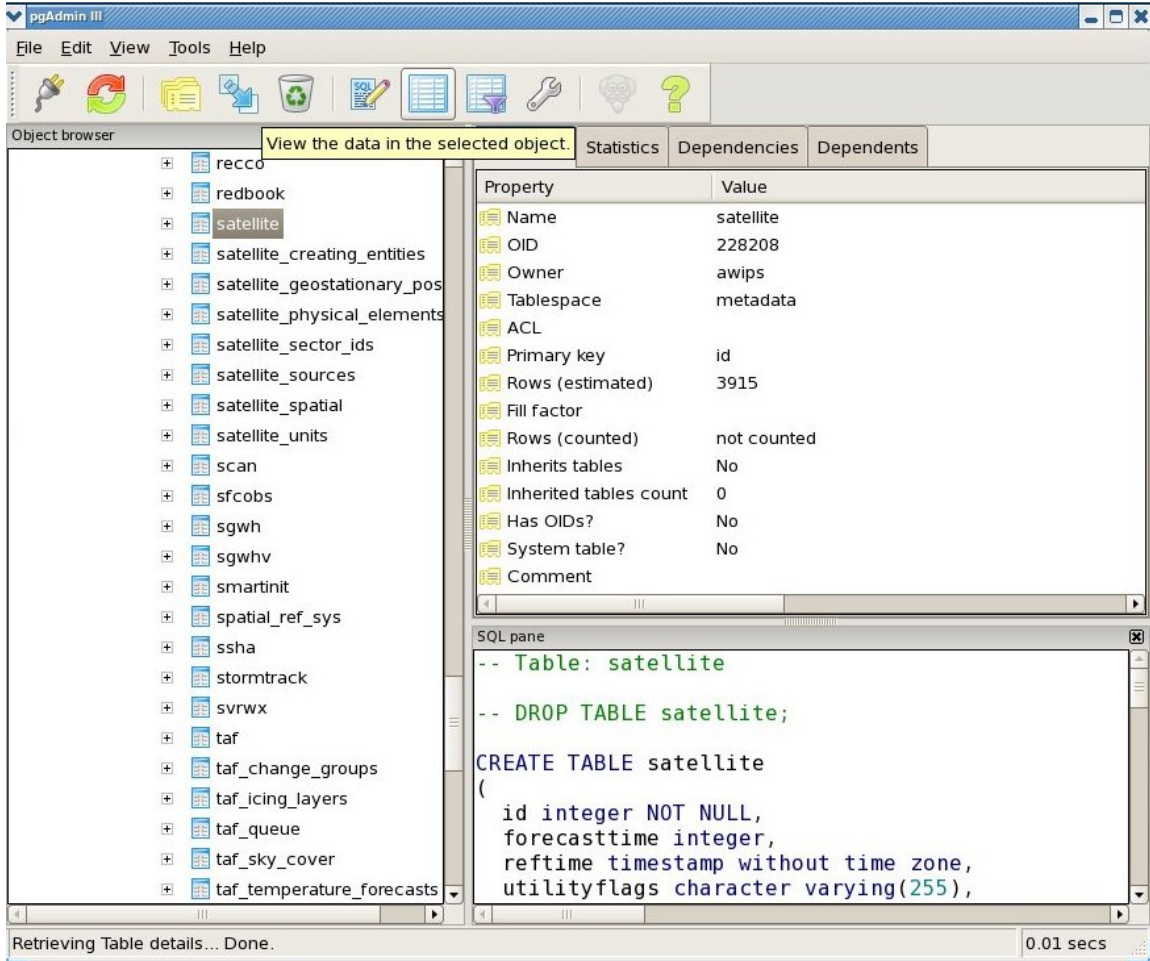

**Exhibit 17.5.1-3 View Data Button**

**Note:** The *Edit Data* window opens and displays a database cursor; any changes made to the data in this window will propagate to the underlying database.

	Id [PK] integ	forecastti Integer	reftime timestamp	utilityflag character	rangeend timestamp	rangestar timestamp	datauri character	inserttime timestamp	hddfield Integer	creating character
1	1506	0	2011-05-18	[]	2011-05-18	2011-05-18	/satellite/20	2011-05-18	204010331	GOES-13(N)
2	1550	0	2011-05-18	[]	2011-05-18	2011-05-18	/satellite/20	2011-05-18	204010331	GOES-13(N)
3	1705	0	2011-05-18	[]	2011-05-18	2011-05-18	/satellite/20	2011-05-18	204010331	GOES-13(N)
4	1768	0	2011-05-18	[]	2011-05-18	2011-05-18	/satellite/20	2011-05-18	204010331	GOES-13(N)
5	2339	0	2011-05-18	[]	2011-05-18	2011-05-18	/satellite/20	2011-05-18	204010331	GOES-13(N)
6	2402	0	2011-05-18	[]	2011-05-18	2011-05-18	/satellite/20	2011-05-18	204010331	GOES-13(N)
7	2595	0	2011-05-18	[]	2011-05-18	2011-05-18	/satellite/20	2011-05-18	204010331	GOES-13(N)
8	2664	0	2011-05-18	[]	2011-05-18	2011-05-18	/satellite/20	2011-05-18	204010331	GOES-13(N)

Scratch pad

1863 rows.

**Exhibit 17.5.1-4: PG Admin III Edit Data Window**

PG Admin III can also be used to execute SQL against the database. In order to execute SQL, you need to open the PG Admin II SQL Query window. To open this window, first find the desired database in the tree view on the left side of the main window and then click the ‘execute SQL’ button (  ) in the toolbar as shown in Exhibit 17.5.1-5. This will display the SQL Query window, shown in the following example (Exhibit 17.5.1-6).

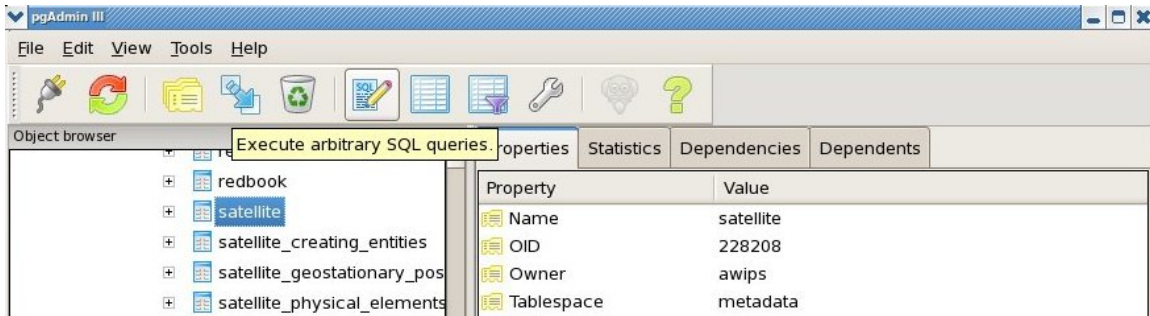

**Exhibit 17.5.1-5: Execute SQL Button**

**Note:** Use extreme care when executing SQL statements against the database. SQL is an extremely powerful database manipulation language and can be used to alter the structure and/or contents of the database. A change made to the database generally cannot be reversed.

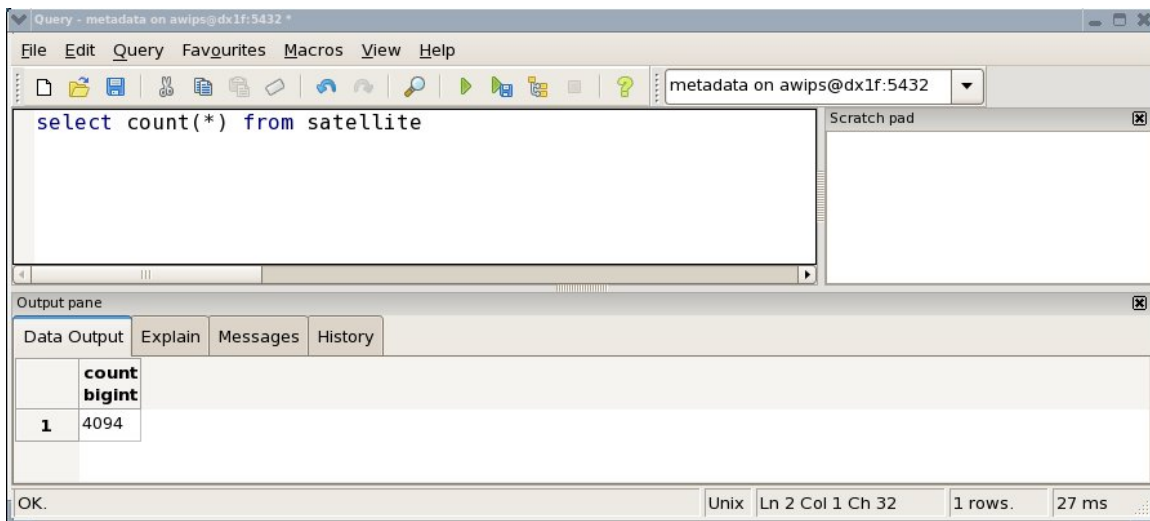

**Exhibit 17.5.1-6: PG Admin III SQL Query Window**

### 17.5.2 HDFView

HDFView is a GUI-based tool that allows you to view the data in an HDF5 file. It provides an Explorer-style interface for locating the data and various options for viewing the data. HDFView is most effective when used to view raster data such as satellite imagery. Note that HDFView errors out when attempting to display Gridded Binary (GRIB) data in AWIPS II.

At the NWS Training Center, HDFView has been installed on both DX1 and DX2 in the directory `/awips2/tools/bin/HDFView/`. Since the AWIPS II HDF5 files are in a file system that is only mounted on the server running the `a2dx1apps` high-availability package, you will log into `dx1f` to run HDFView.

**Note:** HDFView is currently not part of the AWIPS toolset and is not delivered as part of the AWIPS II software delivered by Raytheon. It has been installed on the systems at the NWS Training Center and is available for download at <http://www.hdfgroup.org/hdf-java/html/hdfview> .

Instructions for installing and using `hdfview` are at the AWIPS Evolution web site: [http://www.nws.noaa.gov/ost/SEC/AE/Testing/TO8\\_APP\\_Instructions/TO8QSAdminGuideAttachL.pdf](http://www.nws.noaa.gov/ost/SEC/AE/Testing/TO8_APP_Instructions/TO8QSAdminGuideAttachL.pdf)

Note: Contact your region for `hdfview` installation instructions for your site.

To run HDFView, you will need to do the following:

1. Log on to an LX or XT workstation.
2. Open a terminal window.
3. Remote log into `dx2f`.
4. The `hdfview` executable is `/awips2/tools/bin/hdf-java/HDF-Group/HDFView/2.10.1/bin/hdfview.sh`

This will display the main HDFView window (see Exhibit 17.5.2-1).

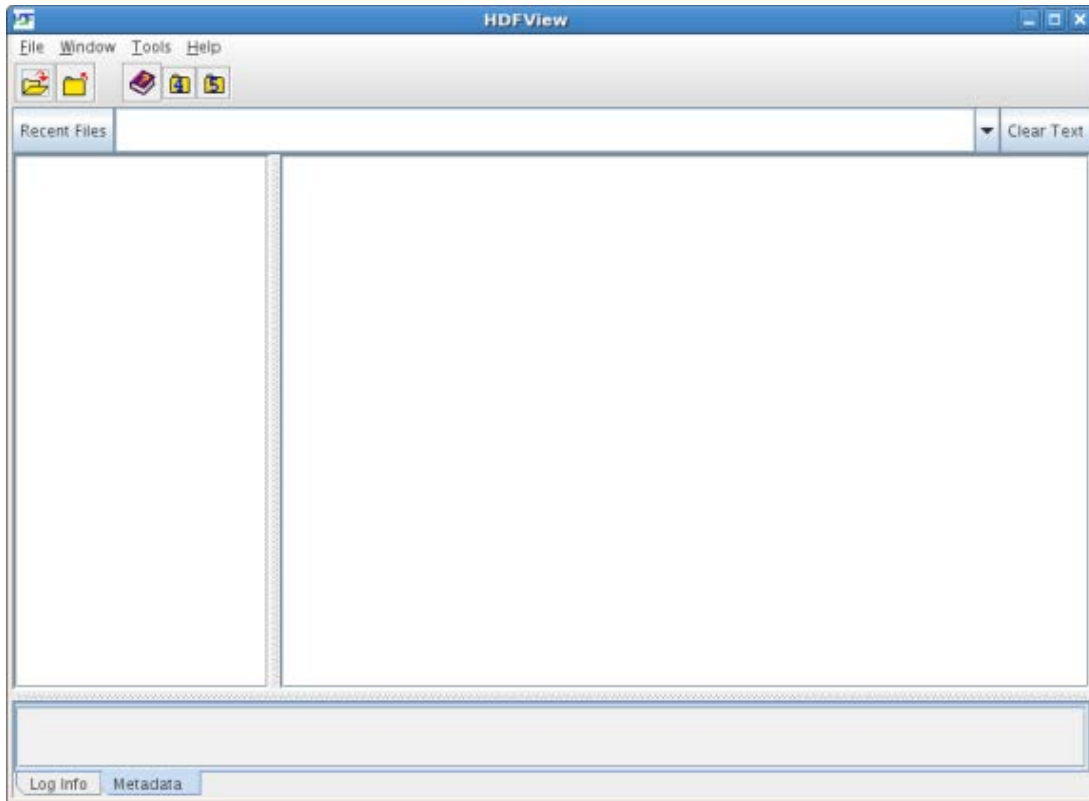

**Exhibit 17.5.2-1. HDFView Main Window**

To locate and load an HDF5 file, select 'File→Open Read-Only' from the HDFView menu. This will display a file open dialog. Browse for the desired file and click 'Open'. This will display the file contents in a tree structure on the left side of the main window (see Exhibit 17.5.2-2).

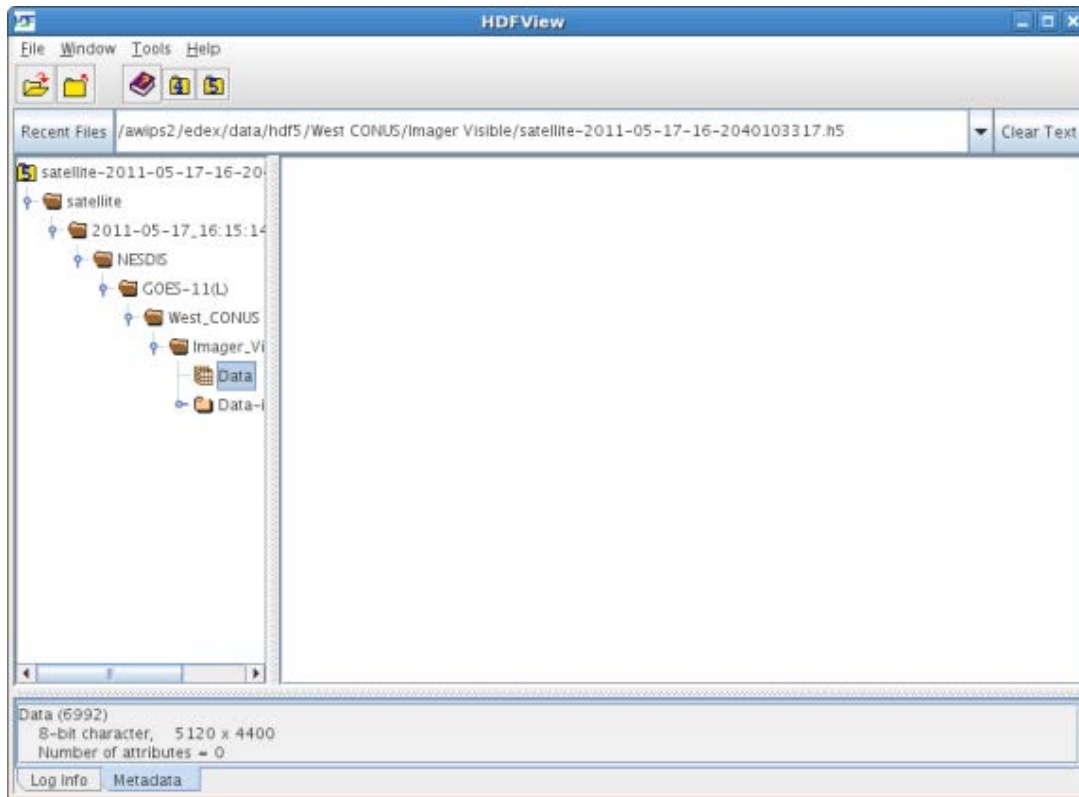

**Exhibit 17.5.2-2. HDFView with File Loaded and Expanded**

To view the product:

1. Expand the tree view to find and click on the data for the desired product.
2. Right click on the data and select 'Open As'.

This opens the Dataset Selection dialog, shown in Exhibit 17.5.2-3.



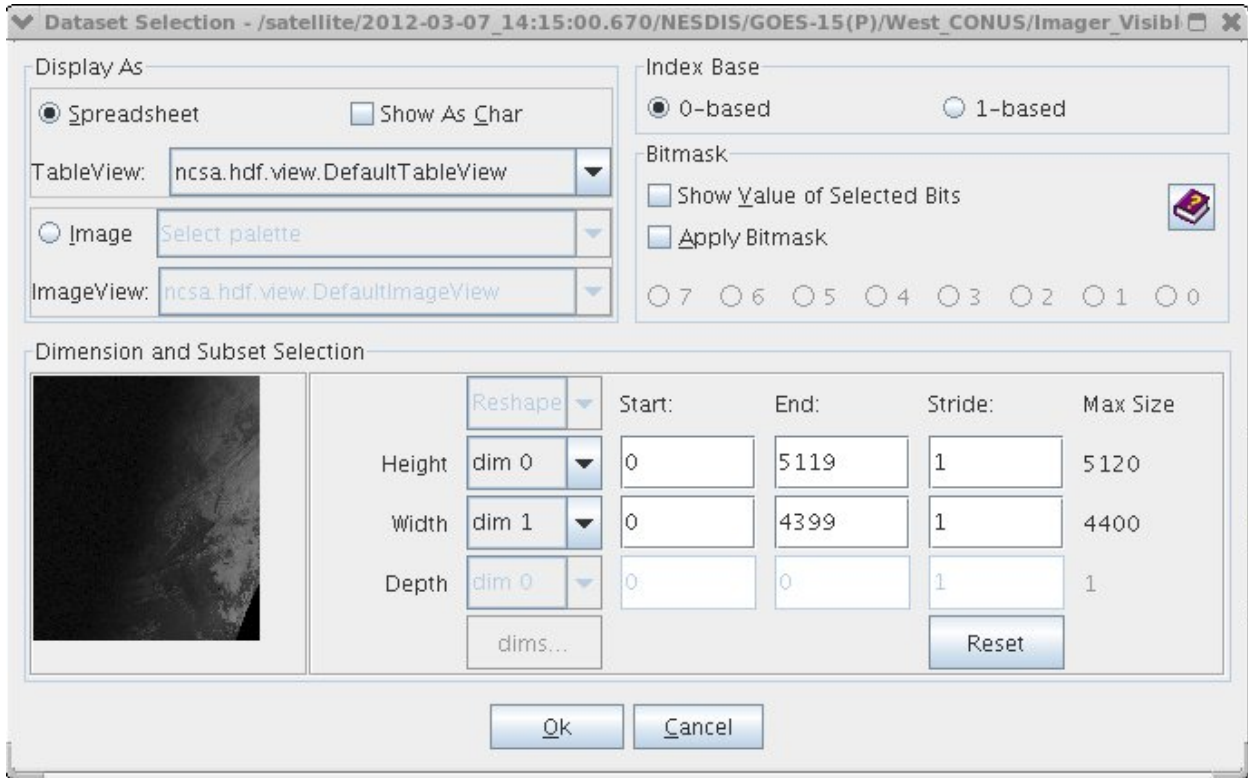

**Exhibit 17.5.2-3. HDFView Dataset Selection Dialog**

From this dialog, you can display the data as a spreadsheet or as an image. Use care when displaying data in the spreadsheet (table) view because the data can be modified in this view. Exhibit 17.5.2-4 illustrates the spreadsheet view; the image view is shown in Exhibit 17.5.2-5.

The screenshot shows the HDFView application window. The main area displays a table view of data. The table has 19 rows and 7 columns. The data is as follows:

	0	1	2	3	4	5	6
0	81	82	84	87	84	86	85
1	80	82	84	87	87	88	87
2	74	78	84	87	87	86	86
3	74	78	84	83	87	86	86
4	74	78	84	83	83	84	86
5	78	81	84	83	83	84	86
6	76	81	79	82	83	84	88
7	76	81	79	82	81	82	88
8	80	77	81	82	81	82	86
9	80	77	82	83	80	82	86
10	80	82	82	83	83	81	86
11	82	82	82	85	83	81	86
12	82	82	85	83	83	85	86
13	82	82	84	83	82	85	86
14	85	81	84	83	84	87	85
15	85	80	84	86	84	87	85
16	81	80	84	83	85	87	86
17	83	81	84	83	85	85	86
18	83	81	81	80	85	85	86

Below the table, the data type is specified as 'Data (6992)', '8-bit character', '5120 x 4400', and 'Number of attributes = 0'. There are buttons for 'Log Info' and 'Metadata' at the bottom left of the data area.

Exhibit 17.5.2-4. HDFView Tableview (Spreadsheet) of Data

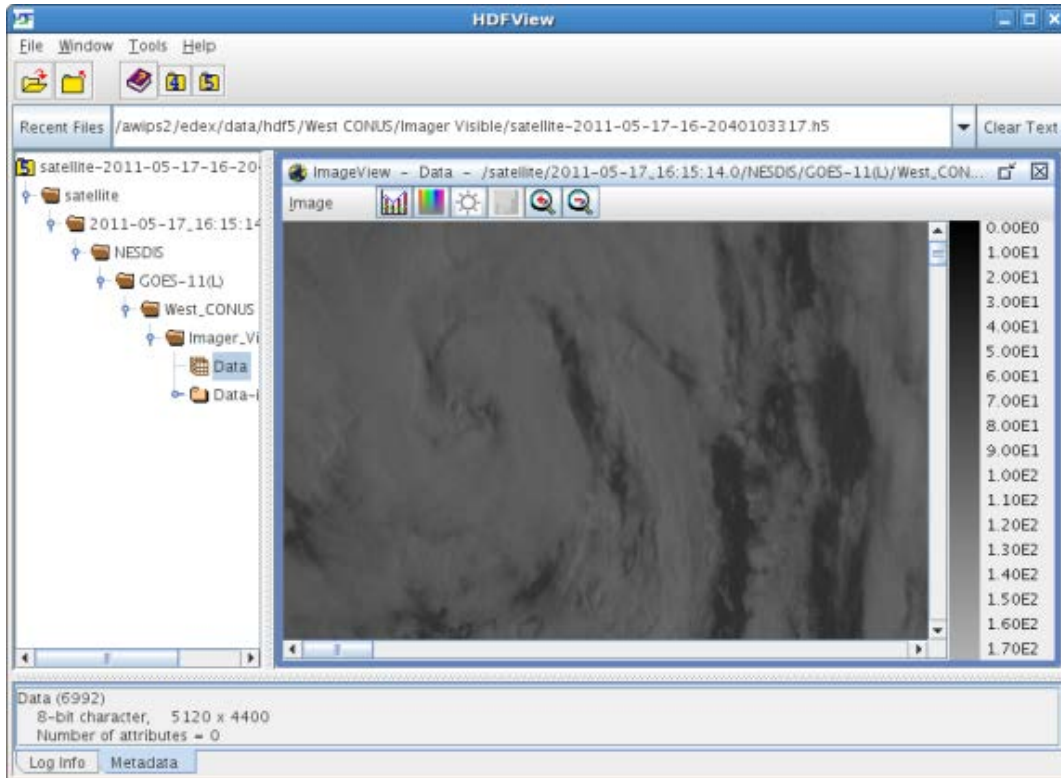

**Exhibit 17.5.2-5. HDFView Image View of Data**

The image can be saved by clicking on “Image -> Save as”.

### **17.5.3 CAVE Product Browser**

The CAVE Product Browser provides an Explorer-style tree view of data and other products that may be viewed in CAVE. It may be added to the selected CAVE perspective by selecting ‘CAVE→Data Browsers→Product Browser’ from the CAVE menu system.

**Note:** Although the CAVE Product Browser may be added to any perspective, this discussion demonstrates adding it to the D2D perspective.

To use the CAVE Product Browser, first launch CAVE on an AWIPS LX or XT workstation. Once CAVE is running, select ‘CAVE→Data Browsers→Product Browser’ from the CAVE menu system. The Product Browser will be added to the right side of the active perspective. (See Exhibit 17.5.3-1.)

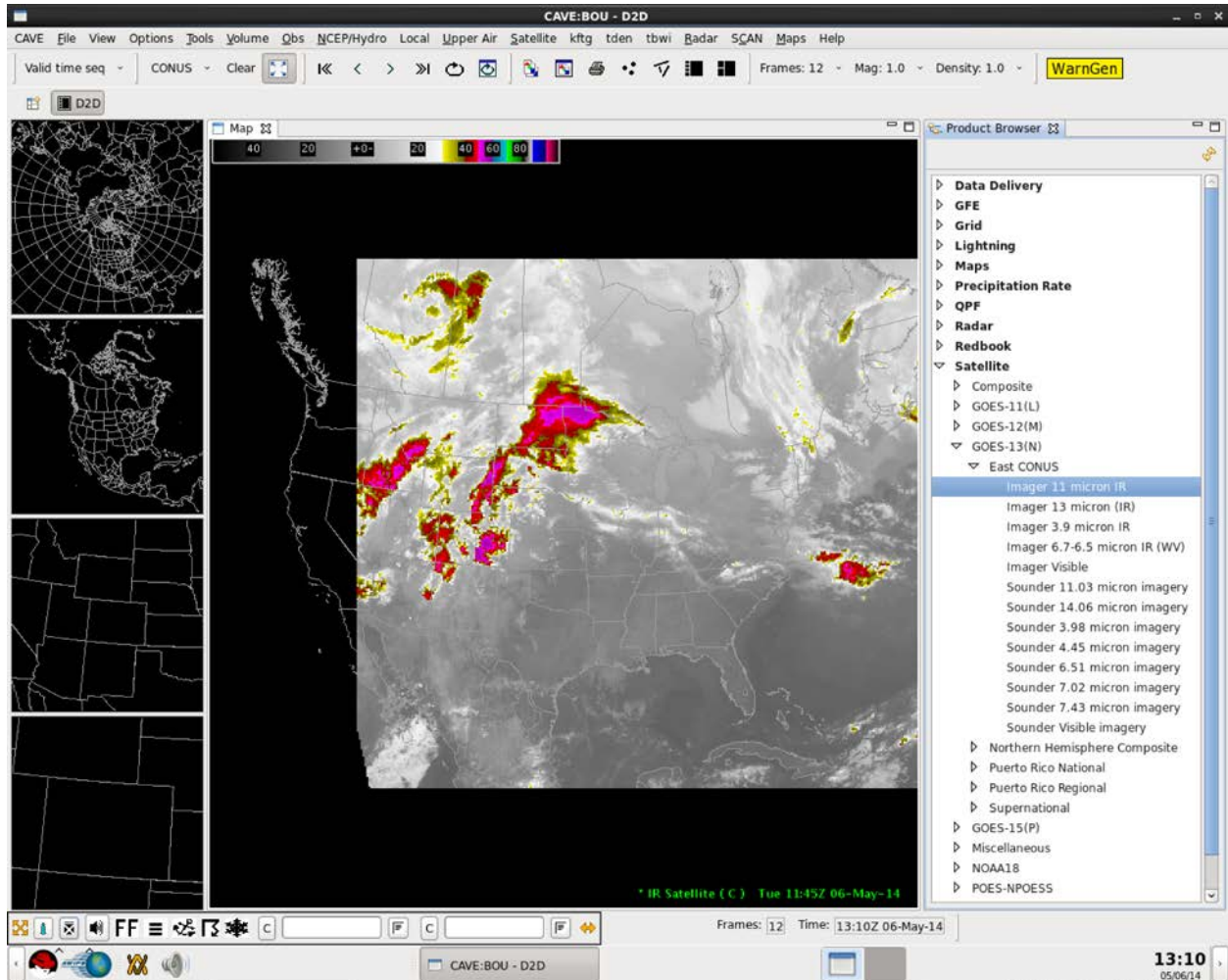

**Exhibit 17.5.3-1. CAVE with Product Browser Displayed**

Once the Product Browser has been loaded, expand the desired product type node to find the desired product; then right click on the product and select 'Load Product'. After a short pause, the selected product will load (see Exhibit 17.5.3-2). [Note: For GRIB products, right click on the product and select 'Load As→Contour' or 'Load As→Image'.]

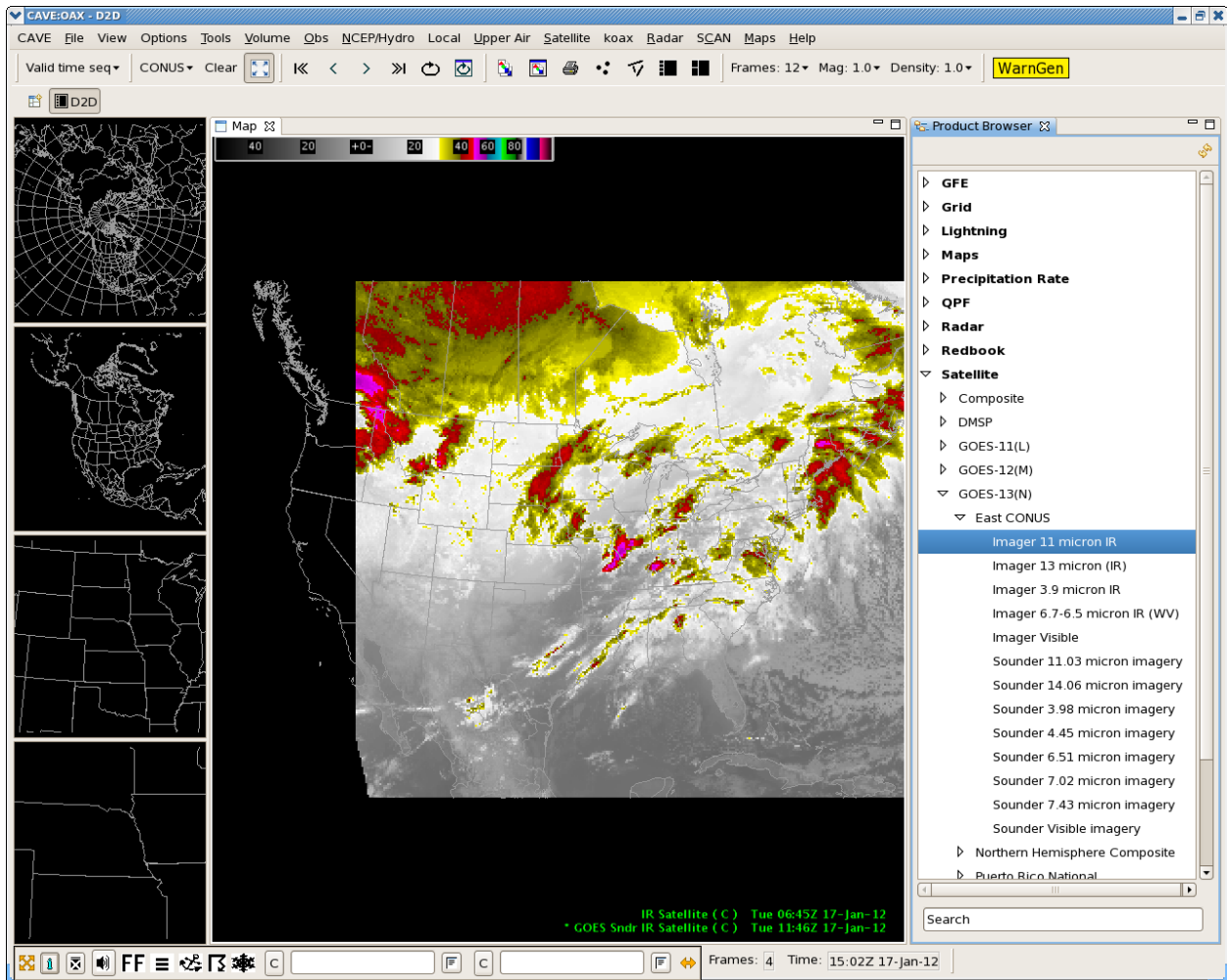

**Exhibit 17.5.3-2. Satellite Product Loaded from Product Browser**

Once the product has been loaded, it can be manipulated the same as any product loaded into D2D. Note in particular that time matching applies to products loaded by this method. As a result, attempting to load multiple products may result in errors being reported in AlertViz.

# **Chapter 18**

## **Failover Management Procedures**

## Chapter 18. Failover Management Procedures

### Table of Contents

	<i>Page</i>
18.1 Communications Processors .....	1
18.1.1 SBN Communications Processors .....	1
18.1.1.1 SBN Communications Processors Failover Procedures .....	2
18.1.1.2 Monitoring Data Acquisition on SBN Communications Processor .....	3
18.2 Linux Servers .....	8
18.2.1 Red Hat Cluster Manager .....	9
18.2.1.1 Linux Data Server Failover Scenarios .....	9
18.2.1.2 Linux Preprocessor Server Failover Scenarios .....	11
18.2.2 Post-Failover Events .....	15
18.2.3 NCF Post-Failover Actions .....	15
18.3 River Ensemble Processors (REP) .....	15
18.3.1 REP Server High-Availability Software .....	16
18.3.2 REP Server Failover Scenarios .....	17
18.3.3 Managing the Heartbeat Cluster Service .....	18
18.3.4 EDEX/IPVS, LDM Failovers .....	19
18.4 AWIPS II to AWIPS I Fallback .....	19
18.4.1 AWIPS I/AWIPS II Co-existence .....	20
18.4.2 Swapping Procedures .....	21
18.4.3 Limitations on System Swapping .....	21

### List of Exhibits

Exhibit 18.2.1.1-1. Cluster Status Monitor .....	11
Exhibit 18.2.1.2-1. Sample Output .....	13
Exhibit 18.2.1.2-2. Sample Verbose Output from Linux Cluster Status Command .....	14

This chapter describes AWIPS failover management procedures. It contains three sections. Section 18.1 describes the communications processors. Refer to Section 18.2 for the Linux data servers (DX) failover management procedures. Section 18.3 describes the River Ensemble Processors (REP).

## 18.1 *Communications Processors*

The Communications Processors (CP) are the front-end processors that allow data to be acquired from sources external to the site. These CPs do not execute hydrometeorological applications. Their primary function is to provide protocol support to the external communication lines.

The SBN CPs support ingest of NESDIS and NWSTG/NWSTG2 data from the Network Control Facility. Failover procedures for each are discussed in this section.

### 18.1.1 *SBN Communications Processors*

The Satellite Broadcast Network (SBN) is the network that distributes weather data from the NCF to receiving sites throughout the United States. The network consists of the uplink Satellite Broadcast Processor (SBP) at the Master Ground Station (MGS) or backup MGS, the uplink MGS antenna in Hauppauge, New York; the backup MGS antenna at the NASA IV&V Facility in Fairmont, West Virginia; the SES-1 satellite; the downlink antenna at the locations receiving data; and the downlink SBP or NOAAPORT Receive Processor (NRP).

There are two components to the ingest software on the CPSBNs in AWIPS II:

1. **LDM NOAAport receiver software.** Ingest from DVB to CPSBN.
2. **UniData LDM software.** Routing/ingest from CPSBN acting as an LDM host (running on cp1f in normal configuration).

In AWIPS II the **LDM NOAAport receiver software** will be used for ingesting all five NOAAPORT Channels.

At each AWIPS site, there are two CPSBNs responsible for receiving GOES products and a combination of NCEP products from the NCF. No site has more than two CPSBNs unless it has an NRS. CPSBN1 and CPSBN2 function as a heartbeat cluster; failover is managed automatically or manually. Note that only a single high-availability package is currently used on this cluster. The package name is a2cp1apps. In failover mode, package execution shifts to the backup server. The a2cp1apps package manages the cp1f floating server name. Note that floating names are available only when the high-availability packages are running; they cannot be used to start or stop the high-availability packages.

First, check for the running of the LDM, as user ldm:

```
TYPE:          ps -U ldm -u ldm u
```



```

[ldm@cpsbn1-tbw3 ~]$ ps -U ldm -u ldm u

ldm  17501 0.0 0.0 24004 1196 ?    Ss  Nov23  0:04 ldmd -I 165.92.24.50 -P 388 -M 256 -m 3600 -o 3600 -q
/usr/local/ldm/data/ldm.

ldm  17503 1.3 3.0 1013208 990496 ?    S   Nov23 203:22 pqact -e

ldm  17504 1.4 2.3 958732 774576 ?    Sl  Nov23 214:59 edexBridge -vxl /usr/local/ldm/logs/edexBridge.log -s
cp1f

root 17505 1.8 3.3 1139936 1089500 ?  SLl Nov23 267:29 noaaportIngester -b 10000 -m 224.0.1.1 -n -u 3 -t mhs -
r 1 -s NMC

root 17506 0.0 3.2 1162764 1081156 ?  SLl Nov23 12:22 noaaportIngester -b 10000 -m 224.0.1.2 -n -u 4 -t mhs -
r 1 -s GOES

root 17507 5.6 6.0 2039288 1991824 ?  SLl Nov23 818:17 noaaportIngester -b 10000 -m 224.0.1.3 -n -u 5 -t mhs -
r 1 -s NMC2

root 17508 0.1 3.2 1142080 1065008 ?  SLl Nov23 19:54 noaaportIngester -b 10000 -m 224.0.1.4 -n -u 6 -t mhs -
r 1 -s NOAAPORT_OPT

root 17509 0.2 3.2 1155368 1073972 ?  SLl Nov23 30:02 noaaportIngester -b 10000 -m 224.0.1.5 -n -u 7 -t mhs -
r 1 -s NMC3

root 17510 0.0 3.2 1136828 1055120 ?  SLl Nov23  0:04 noaaportIngester -b 10000 -m 224.0.1.6 -n -u 4 -t mhs -
r 1 -s ADD

```

Sites normally would only see the first 5 channels listed above. The ADD channel only exists at sites where Data Delivery is activated. As of now, that is limited to test beds and a few regions. Once Data Delivery is “activated and operational”, then all the sites will be able to see the 6th channel (ADD).

In AWIPS II the **UniData LDM** software is used as a replacement for the CP ingest software.

- The file **pqact.conf** located at **/usr/local/ldm/etc** in the LDM installation contains the configuration information that tailors the data flow to AWIPS II.
- The file **pqact.conf** serves the same purpose in AWIPS II as **acq\_patterns.txt** in AWIPS I.

### 18.1.1.1 SBN Communications Processors Failover Procedures

All CPSBN problems that you encounter should be reported immediately to the NCF.

If a CPSBN should fail,

- **Call the NCF.** The CPSBNs for your site can be swapped from the NCF by way of the Simple Network Management Protocol (SNMP). Refer to Exhibit 2.2.1-1 in Chapter 2 for rack configuration.

**NOTE:** During a DX failover, the CPSBNs will remain up and running because they are designed to send data to the active DX.

### 18.1.1.2 Monitoring Data Acquisition on SBN Communications Processor

**NOTE:** To monitor data acquisition you will need **root** access to the system.

Because the DVB has replaced the demods, both CPSBNs receive the complete data stream. At any one time, however, only one CP is actively acquiring and routing the data from the DVBS (default configuration has CPSBN1 active-active, CPSBN2 active-standby).

Connect to the active-active CPSBN1. Then, as user **root**, run the following command to monitor the state of network connections associated with LDM:

```

TYPE:      netstat -ta | grep cpsbn

tcp          0      0 cpsbn2-tbw3.er.:unidata-ldm ***
LISTEN
tcp          0      0 cpsbn2-tbw3.er.awips.:48690 dx1-tbw3:sunrpc
TIME_WAIT
tcp          0      0 cpsbn2-tbw3.er.awi:servstat dx1-tbw3:945
TIME_WAIT
tcp          0      0 cpsbn2-tbw3.er.awips.:43698 dx1-tbw3:sunrpc
TIME_WAIT
tcp          0      0 cpsbn2-tbw3.er.awips.n:1016 dx1-tbw3:945
TIME_WAIT
tcp          0      0 cpsbn2-tbw3.er.awips.:44699 dx1-tbw3:sunrpc
TIME_WAIT
tcp          0      0 cpsbn2-tbw3.er.awips.n:msdp dx1-tbw3:945
TIME_WAIT
tcp          0      0 cpsbn2-tbw3.er.awips.:41527 dx1-tbw3:sunrpc
TIME_WAIT
tcp          0      0 cpsbn2-tbw3.er.awips.:51997 dx1-tbw3:945
TIME_WAIT
tcp          0      0 cpsbn2-tbw3.er.awips.no:ssh cpsbn1-
tbw3.er.awips.:36679 ESTABLISHED
tcp          0      0 cpsbn2-tbw3.er.awips.:58769 dx1-tbw3:sunrpc
TIME_WAIT
tcp          0      0 cpsbn2f-tbw3:ssh          as3-
tncf.er.awips.noa:36244 ESTABLISHED
tcp          0      0 cpsbn2-tbw3.er.awips.:36748 dx1-tbw3:sunrpc
TIME_WAIT
tcp          0      0 cpsbn2-tbw3.er.awips.:36978 dx1-tbw3:sunrpc
TIME_WAIT
tcp          0      0 cpsbn2-tbw3.er.awips.no:vid dx1-tbw3:945
TIME_WAIT
tcp          0      0 cpsbn2-tbw3.er.awips.no:nas dx1-tbw3:945
TIME_WAIT
tcp          0      0 cpsbn2-tbw3.er.awips.:59562 dx1-tbw3:sunrpc
TIME_WAIT
tcp          0      0 cpsbn2-tbw3.er.awips:sshell dx1-tbw3:945
TIME_WAIT
tcp          0      0 cpsbn2-tbw3.er.awips.:48348 dx2-tbw3:domain

```

```

      TIME_WAIT
tcp      0      0 cpsbn2-tbw3.er.awips.no:805 dx1-tbw3:945
      TIME_WAIT
tcp      0      0 cpsbn2-tbw3.er.awips.no:807 dx1-tbw3:945
      TIME_WAIT
tcp      0      0 cpsbn2-tbw3.er.awips.:49542 dx1-tbw3:sunrpc
      TIME_WAIT
tcp      0      0 cpsbn2-tbw3.er.awips.no:811 dx1-tbw3:945
      TIME_WAIT
tcp      0      0 cpsbn2-tbw3.er.awips.no:841 dx1-tbw3:945
      TIME_WAIT
tcp      0      0 cpsbn2-tbw3.er.awips.no:843 dx1-tbw3:945
      TIME_WAIT
tcp      0      0 cpsbn2-tbw3.er.awips.:58037 dx1-tbw3:sunrpc
      TIME_WAIT
tcp      0      0 cpsbn2-tbw3.er.awips.:42662 dx1-tbw3:sunrpc
      TIME_WAIT
tcp      0      0 cpsbn2-tbw3.er.awips.:36442 dx1-tbw3:sunrpc
      TIME_WAIT
tcp      0      0 cpsbn2-tbw3.er:kerberos-adm netapp2-tbw3:nfs
      ESTABLISHED
tcp      0      0 cpsbn2-tbw3.er.awips.no:982 dx1-tbw3:945
      TIME_WAIT
tcp      0      0 cpsbn2-tbw3.er.awips.:60723 dx1-tbw3:sunrpc
      TIME_WAIT
tcp      0      0 cpsbn2-tbw3.er.awips.:39104 dx1-tbw3:sunrpc
      TIME_WAIT
tcp      0      0 cpsbn2-tbw3.er.awips.:51996 dx1-tbw3:945
      TIME_WAIT
tcp      0      0 cpsbn2-tbw3.er.awips.no:845 dx1-tbw3:945
      TIME_WAIT
tcp      0      0 cpsbn2-tbw3.er.awi:hmp-ind dx1-tbw3:945
      TIME_WAIT
tcp      0      0 cpsbn2-tbw3.er.awips.:50509 dx1-tbw3:sunrpc
      TIME_WAIT
tcp      0      0 cpsbn2-tbw3.er.awips.no:839 dx1-tbw3:945
      TIME_WAIT
tcp      0      0 cpsbn2-tbw3.er.awips.:42355 dx1-tbw3:sunrpc
      TIME_WAIT
tcp      0      0 cpsbn2-tbw3.er.:invision-ag dx1-tbw3:sunrpc
      TIME_WAIT
tcp      0      0 cpsbn2-tbw3.er.aw:phonebook dx1-tbw3:945
      TIME_WAIT
tcp      0      0 cpsbn2-tbw3.er.awips.:59758 dx1-tbw3:sunrpc
      TIME_WAIT
tcp      0      0 cpsbn2-tbw3.er.aw:lanserver dx1-tbw3:945
      TIME_WAIT
tcp      0      0 cpsbn2-tbw3.er.awi:dei-icda dx1-tbw3:945
      TIME_WAIT
tcp      0      0 cpsbn2-tbw3.er.awips.:33232 dx1-tbw3:sunrpc
      TIME_WAIT
tcp      0      0 cpsbn2-tbw3.er.awips.:33818 dx1-tbw3:sunrpc
      TIME_WAIT
tcp      0      0 cpsbn2-tbw3.er.awips.no:809 dx1-tbw3:945
      TIME_WAIT
tcp      0      0 cpsbn2-tbw3.er.awips.:56854 dx1-tbw3:sunrpc
      TIME_WAIT
tcp      0      0 cpsbn1f-tbw3:58207          cpsbn1f-tbw3:amqp
      ESTABLISHED
tcp      0      0 cpsbn2-tbw3.er.awi:connendp dx1-tbw3:945
      TIME_WAIT

```

```

tcp      0      0 cpsbn2-tbw3.er.awip:webster dx1-tbw3:945
TIME_WAIT
tcp      0      0 cpsbn2-tbw3.er.awips.:33571 dx1-tbw3:sunrpc
TIME_WAIT
tcp      0      0 cpsbn2-tbw3.er.awips.:57316 dx1-tbw3:sunrpc
TIME_WAIT
tcp      0      0 cpsbn2-tbw3.er.awips.:pop3s dx1-tbw3:945
TIME_WAIT
tcp      0      0 cpsbn2-tbw3.er.awips.:33194 dx1-tbw3:sunrpc
TIME_WAIT
tcp      0      0 cpsbn2-tbw3.er.awips.:59696 dx1-tbw3:sunrpc
TIME_WAIT
tcp      0      0 cpsbn2-tbw3.er.awips.n:1019 dx1-tbw3:945
TIME_WAIT
tcp      0      0 cpsbn2-tbw3.:msexch-routing dx1-tbw3:945
TIME_WAIT
tcp      0      0 cpsbn2-tbw3.er.awips.:imaps dx1-tbw3:945
TIME_WAIT
tcp      0      0 cpsbn2-tbw3.er.awips.:56298 dx1-tbw3:sunrpc
TIME_WAIT
tcp      0      0 cpsbn2-tbw3.er.awips.:38955 dx1-tbw3:sunrpc
TIME_WAIT
tcp      0      0 cpsbn2-tbw3.er.awips.:47056 dx1-tbw3:sunrpc
TIME_WAIT
tcp      0      0 cpsbn2-tbw3.er.awips.n:1021 dx1-tbw3:945
TIME_WAIT
tcp      0      0 cpsbn2-tbw3.er.awips.n:1014 dx1-tbw3:945
TIME_WAIT
tcp      0      0 cpsbn2-tbw3.er.awips.:38072 dx1-tbw3:sunrpc
TIME_WAIT
tcp      0      0 cpsbn2-tbw3.er.awips.no:725 netapp1-tbw3:nfs
ESTABLISHED
tcp      0      0 cpsbn2-tbw3.er.awips.no:gii dx1-tbw3:945
TIME_WAIT
tcp      0      0 cpsbn2-tbw3.er.awips.:39408 dx1-tbw3:sunrpc
TIME_WAIT
tcp      0      0 cpsbn2-tbw3.er.awips.:58105 dx1-tbw3:sunrpc
TIME_WAIT
tcp      0      0 cpsbn2-tbw3.er.awips.n:rtip dx1-tbw3:945
TIME_WAIT
tcp      0      0 cpsbn2-tbw3.er.awi:rlzdbase dx1-tbw3:945
TIME_WAIT
tcp      0      0 cpsbn2-tbw3.er.awips.:40762 dx1-tbw3:sunrpc
TIME_WAIT
tcp      0      0 cpsbn2-tbw3.er.awips.:34422 dx1f-
tbw3.er.awips:postgres TIME_WAIT
tcp      0      0 cpsbn2-tbw3.er.awips.:34406 dx1f-
tbw3.er.awips:postgres TIME_WAIT
tcp      0      0 cpsbn2-tbw3.er.awips.:34413 dx1f-
tbw3.er.awips:postgres TIME_WAIT
tcp      0      0 cpsbn2-tbw3.er.awips.:34424 dx1f-
tbw3.er.awips:postgres TIME_WAIT
tcp      0      0 cpsbn2-tbw3.er.awips.:34470 dx1f-
tbw3.er.awips:postgres ESTABLISHED
tcp      0      0 cpsbn2-tbw3.er.awips.:34445 dx1f-
tbw3.er.awips:postgres ESTABLISHED
tcp      0      0 cpsbn2-tbw3.er.awips.:34384 dx1f-
tbw3.er.awips:postgres TIME_WAIT
tcp      0      0 cpsbn2-tbw3.er.awips.:34452 dx1f-
tbw3.er.awips:postgres ESTABLISHED
tcp      0      0 cpsbn2-tbw3.er.awips.:34418 dx1f-

```

```

tbw3.er.awips:postgres TIME_WAIT
tcp      0      0 cpsbn2-tbw3.er.awips.:34328 dx1f-
tbw3.er.awips:postgres TIME_WAIT
tcp      0      0 cpsbn2-tbw3.er.awips.:34411 dx1f-
tbw3.er.awips:postgres ESTABLISHED
tcp      0      0 cpsbn2-tbw3.er.awips.:34474 dx1f-
tbw3.er.awips:postgres ESTABLISHED
tcp      0      0 cpsbn2-tbw3.er.awips.:34419 dx1f-
tbw3.er.awips:postgres TIME_WAIT
tcp      0      0 cpsbn2-tbw3.er.awips.:34463 dx1f-
tbw3.er.awips:postgres ESTABLISHED
tcp      0      0 cpsbn2-tbw3.er.awips.:34415 dx1f-
tbw3.er.awips:postgres TIME_WAIT
tcp      0      0 cpsbn2-tbw3.er.awips.:34420 dx1f-
tbw3.er.awips:postgres TIME_WAIT
tcp      0      0 cpsbn2-tbw3.er.awips.:34592 dx1f-
tbw3.er.awips:postgres ESTABLISHED
tcp      0      0 cpsbn2-tbw3.er.awips.:34412 dx1f-
tbw3.er.awips:postgres TIME_WAIT
tcp      0      0 cpsbn2-tbw3.er.awips.:34408 dx1f-
tbw3.er.awips:postgres ESTABLISHED
tcp      0      0 cpsbn2-tbw3.er.awips.:34462 dx1f-
tbw3.er.awips:postgres ESTABLISHED
tcp      0      0 cpsbn2-tbw3.er.awips.:34423 dx1f-
tbw3.er.awips:postgres TIME_WAIT
tcp      1      0 cpsbn2-tbw3.er.awips.:42562 dx2f-
tbw3.er.awips.noa:9582 CLOSE_WAIT
tcp      0      0 cpsbn2-tbw3.er.awips.:34232 dx1f-
tbw3.er.awips:postgres TIME_WAIT
tcp      0      0 cpsbn2-tbw3.er.awips.:34332 dx1f-
tbw3.er.awips:postgres TIME_WAIT
tcp      0      0 cpsbn2-tbw3.er.awips.:34383 dx1f-
tbw3.er.awips:postgres ESTABLISHED
tcp      0      0 cpsbn2-tbw3.er.awips.:34417 dx1f-
tbw3.er.awips:postgres TIME_WAIT
tcp      0      0 cpsbn2-tbw3.er.awips.:34479 dx1f-
tbw3.er.awips:postgres ESTABLISHED
tcp      0      0 cpsbn2-tbw3.er.awips.:34460 dx1f-
tbw3.er.awips:postgres ESTABLISHED
tcp      0      0 cpsbn2-tbw3.er.awips.:34437 dx1f-
tbw3.er.awips:postgres TIME_WAIT
tcp      0      0 cpsbn2-tbw3.er.awips.:34421 dx1f-
tbw3.er.awips:postgres TIME_WAIT
tcp      0      0 cpsbn2-tbw3.er.awips.:34414 dx1f-
tbw3.er.awips:postgres TIME_WAIT
tcp      0      0 cpsbn2-tbw3.er.awips.:34480 dx1f-
tbw3.er.awips:postgres ESTABLISHED
tcp      0      0 cpsbn2-tbw3.er.awips.:34425 dx1f-
tbw3.er.awips:postgres TIME_WAIT
tcp      0      0 cpsbn2-tbw3.er.awips.:34225 dx1f-
tbw3.er.awips:postgres TIME_WAIT
tcp      0      0 cpsbn2-tbw3.er.awips.:34416 dx1f-
tbw3.er.awips:postgres TIME_WAIT

```

Log files for SBN ingest on the active-active CPSBN are located under `/data/ldm/logs` and controlled via the rsyslog daemon (**rsyslogd**), which is started by the **init** process in runlevels 2-3-4-5. To check to see if the **rsyslog** process is running run, as user **root**:

**TYPE:** `service rsyslog status`

```
rsyslogd (pid 2371) is
running...
```

The process ID (PID) will be returned along with the status of running if the process is currently active.

**NOTE:** Output when the service command is run by a non-root user will appear to show the process (in this case **rsyslogd**) as “dead,” which is inaccurate.

The configuration files for the **rsyslogd** are located in **/etc** and **/etc/sysconfig**. They are:

```
/etc/rsyslog.d/cpawips.conf
/etc/sysconfig/rsyslog
```

The configuration file **/etc/sysconfig/rsyslog** controls the daemon logging options, while **/etc/rsyslog.d/cpawips.conf** controls the user-level process logging and in this case the **LDM** logging configuration.

Inside **/etc/rsyslog.d/cpawips.conf** are entries for the logging of LDM:

```
local1.*                /var/log/cluster
local0.debug            -/data/ldm/logs/ldmd.log
local3.debug            -/data/ldm/logs/nwstg.log
local4.debug            -/data/ldm/logs/goes_add.log
local5.debug            -/data/ldm/logs/nwstg2.log
local6.debug            -/data/ldm/logs/oconus.log
local7.debug            -/data/ldm/logs/polarsat.log
$umask 0022
local0;local4.none      /var/log/messages
```

These entries dictate the location for the logging facility of the various LDM NOAAport receivers that acquire the SBN data feed from the DVBS. The first entry in **/etc/rsyslog.d/cpawips.conf** is also pertinent to LDM because it “excludes” the logging of the NOAAport receivers from the facility **messages**. The logging facility for the NOAAport receivers is defined in the LDM source.

To watch the receipt of data from the DVBS to the LDM, the above logfiles may be monitored or the **ldmadmin** utility used to view the feed in real-time. As user **ldm** on the active-active CPSBN:

```

TYPE:          ldmadmin watch

Jan 22 18:57:07 pqutil INFO:      5277 20140122185706.895 NEXRAD3
65978838 SDUS86 KSEW 221853 /pN3HATX !nids/
Jan 22 18:57:07 pqutil INFO:      1274 20140122185706.895 NEXRAD3
65978839 SDUS33 KEAX 221849 /pPTAEAX
Jan 22 18:57:07 pqutil INFO:      21458 20140122185706.897      HDS
65978840 YUWI35 KWBG 221800 /mRUC2
!grib/ncep/RUC2/#236/201401221800/F008/UGRD/350 mb/
Jan 22 18:57:07 pqutil INFO:      5441 20140122185706.900 NEXRAD3
65978841 SDUS23 KPAH 221851 /pN1SVWX
Jan 22 18:57:07 pqutil INFO:      4790 20140122185706.901 NEXRAD3
65978842 SDUS25 KTWC 221850 /pN2SEMX
Jan 22 18:57:07 pqutil INFO:      25886 20140122185706.903 NEXRAD3
65978843 SDUS50 PHFO 221854 /pDHRHMO !nids/
Jan 22 18:57:07 pqutil INFO:      19326 20140122185706.905      HDS
65978844 YVWI86 KWBG 221800 /mRUC2
!grib/ncep/RUC2/#236/201401221800/F008/VGRD/150-120 mb above gnd/
Jan 22 18:57:07 pqutil INFO:      11254 20140122185706.905 NEXRAD3
65978845 SDUS21 KBUF 221853 /pN1QBUF !nids/
Jan 22 18:57:07 pqutil INFO:       149 20140122185706.906      HDS
65978846 NXUS64 KFWD 221856 /pGSMGRK
Jan 22 18:57:07 pqutil INFO:      2223 20140122185706.906 NEXRAD3
65978847 SDUS32 KMFL 221847 /pNVWAMX
Jan 22 18:57:07 pqutil INFO:      14069 20140122185706.911 NEXRAD3
65978848 SDUS25 KTWC 221850 /pN2UEMX !nids/
Jan 22 18:57:07 pqutil INFO:      19326 20140122185706.912      HDS
65978849 YUWI86 KWBG 221800 /mRUC2
!grib/ncep/RUC2/#236/201401221800/F008/UGRD/60-30 mb above gnd/
Jan 22 18:57:07 pqutil INFO:      4954 20140122185706.913 NEXRAD3
65978850 SDUS38 PAFC 221853 /pN3SAKC
Jan 22 18:57:07 pqutil INFO:       285 20140122185706.913 NEXRAD3
65978851 SDUS54 KHGX 221850 /pNVLHOU
Jan 22 18:57:07 pqutil INFO:      19326 20140122185706.914      HDS
65978852 YRWI86 KWBG 221800 /mRUC2
!grib/ncep/RUC2/#236/201401221800/F008/RH/150-120 mb above gnd/

```

**NOTE:** Further information on the LDM and LDM monitoring may be obtained by visiting the UniData LDM Monitoring website @ <http://www.unidata.ucar.edu/software/ldm/ldm-6.6.5/basics/monitoring.html>

## 18.2 Linux Servers

The four DX servers have been paired into two, two-server clusters. DX1 and DX2 are managed by a third-party software product that maintains a continuous heartbeat between the two members of the failover pair and accomplishes an automatic processing switch to the secondary processor should the primary processor fail. DX3 and DX4 do not form a primary/backup server pair. Rather, the EDEX processes run on both servers. EDEX uses

QPID and the IP Virtual Server (IPVS), running on the CP1/2 cluster, to provide both load balancing and request balancing. IPVS is used to load-balance the connections from clients (AlertViz, CAVE, etc.) to the EDEX cluster (DX3/4). It is configured so that, when an incoming connection request is made to the IPVS virtual server, it looks to see which server, DX3 or DX4, has the smaller number of connections. It then routes the connection to that server. If DX3 and DX4 have the same number of active connections, it routes to DX4 by default because it is configured with DX4 weighted higher than DX3.

### ***18.2.1 Red Hat Cluster Manager***

The Red Hat Cluster Manager provides automatic failover when either of the active PXs or DXs in the AWIPS configuration is lost. The AWIPS functionality hosted on that PX/DX server will automatically swap to the remaining corresponding server. An automatic failover action causes a configuration alarm event to be forwarded to the NCF via an SNMP trap.

The Red Hat Cluster Manager uses the concept of a cluster made up of nodes within its managed environment. The Linux Data Servers are paired as two, two-server clusters (DX1/DX2, DX3/DX4), and the Linux Preprocessor Servers (PX1 and PX2) are the members of the AWIPS Red Hat Cluster Manager cluster configuration.

The Red Hat Cluster Manager also uses the concept of “services” to transfer responsibilities from one network node to another. For the purposes of AWIPS configuration, the DXs (two pairs) make up two distinct package groups and the PXs make up two distinct package groups.

#### ***18.2.1.1 Linux Data Server Failover Scenarios***

##### **Key Components**

- **Node.** Linux Data Server (DX).
- **Cluster.** Networked group of managed nodes (DX1 and DX2, DX3 and DX4).
- **Package.** The Red Hat Cluster Manager refers to “services,” which are equivalent to MC/ServiceGuard “packages.” The Red Hat Cluster Manager uses redundant hardware, shared disk storage, power management, and robust cluster communication and application failover mechanisms. The DX service/package names are:
  - **a2dx1apps**
  - **a2dx2apps**
  - **a2dx3apps**
  - **a2dx4apps.**



**NOTE:** In AWIPS II, the package-naming concept is preserved, but with an “a2” preceding the name. For example, in AWIPS I includes a package named `dx1apps`. In AWIPS II this package is modified and renamed **`a2dx1apps`**. The same naming convention is preserved for `ingest`. AWIPS I has an `ingest` script named `startIngest.dx1`. In AWIPS II this script is modified and renamed **`startA2Ingest.dx1`**. Similarly, the HA cronfiles also exist; they are named **`a2dx1cron`** and **`a2SITEdx1cron`**.

When issuing an `hb_stat` on a device that is not currently configured to have a package managed (e.g., DX3/DX4) you will see:

**dx3-tbw3 is not part of an heartbeat cluster**

**NOTE:** The device name will change depending on the server on which the command is issued.

The heartbeat services are stopped on those nodes that do not manage any packages or resources. However, the `hb_stat` will still execute because the command performs a sanity check not on whether the heartbeat process is running, but rather on the existence of the heartbeat RPM in the rpm-database.

- **Floating IP Address:** Relocatable IP address that can move between like nodes in a cluster as opposed to a stationary IP address (e.g., `dx1f-<siteID>`, `dx2f-<siteID>`, `dx3f-<siteID>`, and `dx4f-<siteID>`, instead of `dx1-<siteID>`, `dx2-<siteID>`, `dx3-<siteID>`, and `dx4-<siteID>`).

### Red Hat Cluster Manager Failovers

AWIPS supports two types of Red Hat Cluster Manager failovers – automatic and manual.

- **Automatic Failover.** If a DX fails, its associated package will be transferred automatically to the other node/server (backup server) in the package group (DX1 to DX2 and vice versa; DX3 to DX4 and vice versa). Failure scenarios, triggering automatic failover, include the following:
  - Loss of SCSI connectivity
  - Loss of Ethernet connectivity
  - CPU hang or panic
  - CPU failure
  - System disk failure
  - Power failure.
- **Manual Failover.** There may be times when you will want to have a manual failover initiated (for example, if the software on the primary node fails to operate properly or if the disk on the primary node becomes corrupted). As the system manager, you need

to communicate the request for a manually initiated failover to the NCF; it is the NCF's responsibility to initiate all manual failovers using Red Hat Cluster Manager.

### Failover Time

The DX failover time, under normal conditions, is about 2 to 3 minutes.

### Package Switching

When a DX failure occurs, the resident DX package is switched to the other DX because each is capable of handling the full load of applications as a backup node. Once the failed node has been revived, the package that moved should be transferred back to its original node (server). The transition back to the original node should be scheduled with the NCF (which is responsible for the transition) in advance to ensure it occurs at an appropriate time (i.e., not during a severe weather condition).

To verify that swap packages are enabled for the swap package (**a2dx1apps**), as user **root**,

**TYPE:** `hb_stat`

- **Result:** Look for output similar to Exhibit 18.2.1.1-1.

```
Heartbeat Status Monitor                               Nov 02 18:15:29

===== Member Status =====

  Member      Status  IP address
  -----
  dx1-tbdw    Up      165.92.29.131
  dx2-tbdw    Up      165.92.29.132

===== Service Status =====

  Service      IPAddr      Cronfile      Owner      Start Time
  -----
  a2dx1apps    165.92.29.195  a2dx1cron,a2SIT dx1-tbdw  2011-07-11 20:21:50
  a2dx2apps    165.92.29.196  a2dx2cron,a2SIT dx2-tbdw  2011-10-21 17:05:18
```

**Exhibit 18.2.1.1-1. Cluster Status Monitor**

### 18.2.1.2 Linux Preprocessor Server Failover Scenarios

#### Key Components

- **Node.** Linux Preprocessor Server (PX).
- **Cluster.** Networked group of managed nodes (PX1 and PX2).
- **Package.** The Red Hat Cluster Manager refers to “services,” which are equivalent to MC/ServiceGuard “packages.” The Red Hat Cluster Manager uses redundant

hardware, shared disk storage, power management, and robust cluster communication and application failover mechanisms. PX service/package names:

- **a2px1apps** (usually runs on px1-<siteID>, may run on px2)
- **a2px2apps** (usually runs on px2-<siteID>, may run on px1).
- **Floating IP Address.** Relocatable IP address that can move between like nodes in a cluster as opposed to a stationary IP address (e.g., px1f-<siteID> and px2f-<siteID> instead of px1-<siteID> or px2-<siteID>).

### Red Hat Cluster Manager Failovers

AWIPS supports two types of Red Hat Cluster Manager failovers – automatic and manual.

- **Automatic Failover.** If a PX fails, its associated package will be transferred automatically to the other node/server (backup server) in the package group. Failure scenarios, triggering automatic failover, include the following:
  - Loss of SCSI connectivity
  - Loss of Ethernet connectivity
  - CPU hang or panic
  - CPU failure
  - System disk failure
  - Power failure.
- **Manual Failover.** At times you may want to have a manual failover initiated (for example, if the software on the primary node fails to operate properly or if the disk on the primary node becomes corrupted). As the system manager, you need to communicate the request for a manually initiated failover to the NCF; it is the NCF's responsibility to initiate all manual failovers using Red Hat Cluster Manager.

### Failover Time

The PX failover time, under normal conditions, is about 2 to 3 minutes.

### Package Switching

When a PX failure occurs, the resident PX package is switched to the other PX because each is capable of handling the full load of applications as a backup node. Once the failed node has been revived, the package that moved should be transitioned back to its original node (server). The NCF is responsible for this transition.

The transition back to the original node should be scheduled with the NCF in advance so that it can occur at an appropriate time (i.e., not during a severe weather condition).

To verify that swap packages have been enabled for each swap package (**px1apps** and **px2apps**) as user **root**,

**TYPE:** `hb_stat`

- **Result:** Look for output similar to Exhibit 18.2.1.2-1. Exhibit 18.2.1.2-2 shows output of a verbose version of this command (`hb_stat -v`).

```
Heartbeat Status Monitor                               Jul 21 14:16:00
===== M e m b e r   S t a t u s =====
Member      Status      IP address
-----
px1-tbw3    Up          165.92.24.7
px2-tbw3    Up          165.92.24.8

===== S e r v i c e   S t a t u s =====
Service     IPaddr      Cronfile      Owner         Start Time
-----
a2px1apps   165.92.24.63  a2px1cron,a2SIT px1-tbw3     2012-12-06 19:52:33
a2px2apps   165.92.24.64  a2px2cron,a2SIT px2-tbw3     2012-12-10 14:15:03
```

**Exhibit 18.2.1.2-1. Sample Output**

```

Heartbeat Status Monitor                                     Jul 21 14:15:32
===== Member Status =====

Member      Status      IP address
-----
px1-tbw3    Up          165.92.24.7
px2-tbw3    Up          165.92.24.8

===== Heartbeat Status =====

Node        Type        Devices                                     Status
-----
px1-tbw3    ucast       bond0 165.92.24.8                          Up
px1-tbw3    ucast       eth1 10.0.4.2                               Up
px1-tbw3    ping        router-tbw3                                 Up
px2-tbw3    ucast       bond0 165.92.24.7                          Up
px2-tbw3    ping        router-tbw3                                 Up

===== Service Status =====

Service      IPAddr      Cronfile      Owner      Start Time
-----
a2px1apps    165.92.24.63  a2px1cron,a2SIT px1-tbw3    2012-12-06 19:52:33
a2px2apps    165.92.24.64  a2px2cron,a2SIT px2-tbw3    2012-12-10 14:15:03

===== Resource Status =====

Resource      Parameters      Owner      Status      Start Time
-----
caveData: Unknown host
ifconfig: '--help' gives usage information.
IPAddr        165.92.24.63      px1-tbw3    unknown
a2px1apps     a2px1cron         px1-tbw3    OK          2012-12-06 19:52:33
Crontab       a2px1cron         px1-tbw3    OK          2012-12-06 19:52:33
Crontab       a2SITEpx1cron     px1-tbw3    OK          2012-12-06 19:52:33
IPAddr        165.92.24.64      px2-tbw3    unknown
a2px2apps     a2px2cron         px2-tbw3    OK          2012-12-10 14:15:03
Crontab       a2px2cron         px2-tbw3    OK          2012-12-10 14:15:03
Crontab       a2SITEpx2cron     px2-tbw3    OK          2012-12-10 14:15:03
Crontab       archiver          px2-tbw3    OK          2012-12-10 14:15:03

```

**Exhibit 18.2.1.2-2. Sample Verbose Output from Linux Cluster Status Command**

In AWIPS II the **a2px2apps** also controls the following:

- **LDM edexBridge.** LDM edexBridge actually runs on cplf, except at sites with remote CPs (VRH, GUM and HFO). It is stopped/started along with the LDM software.
- **Apache daemon.** This is the httpd process that controls the AWIPS II System Monitor webpage. The resource configuration stops|starts the httpd process.

**NOTE:** All the above processes (**LDM edexBridge** and **Apache daemon**) are controlled via failover management and require no site or user interaction to configure or control outside of the cluster management suite.

### 18.2.2 Post-Failover Events

Events that take place after an automatic or manually initiated failover are as follows:

- The Red Hat Cluster Manager service will be swapped to the failover node.
- The NCF will be notified, by way of a pop-up dialog or an audible alarm from within HP OpenView Operations (OVO), of the swap completion and of the failover node in question. The node outage is alarmed (red) within OVO. The pop-up alarm is triggered by way of an SNMP trap sent to OVO at the NCF by Red Hat Cluster Manager at the site.

### 18.2.3 NCF Post-Failover Actions

NCF post-failover actions are provided for site information. NCF operators follow procedures contained in the Trouble Ticket software's knowledge base, i.e.:

- Contact the site to confirm failover.
- Perform analysis of the new system to determine if any problems have occurred during failover and, if so, take the following appropriate steps to correct them:
  - View status of node and package
  - Examine package log file
  - Examine system for known problems.
- Execute various manual procedures to complete additional operations not included as a normal swap function.
- Recontact the site to determine if the site is continuing to acquire and process data (desktop data display applications are receiving and able to display the appropriate product data).

## 18.3 River Ensemble Processors (REP)

Two River Ensemble Processors (REP) are located at each RFC AWIPS site. The REP suite, part of the NWS' Advanced Hydrologic Prediction Service (AHPS) program, was designed as a high-performance "blank slate" on which the RFCs can load new or site-modified applications in an environment that is very similar to AWIPS. It includes an availability infrastructure that allows failing-over of processes and crons if desired. In the future, this hardware will host "baseline" OH applications implemented via AWIPS or AHPS, as appropriate. The REP provides the RFCs with a platform designed for easy expansion based on mission requirements. The REP suite was delivered as a self-

contained unit that includes a rack, a NAS device, two commodity servers, a GbE LAN, and a tape backup device. The servers are installed with Red Hat Linux 7.2. The file system structure of the servers and NAS is consistent with current operations and is ready to support installation of hydrology software.

### 18.3.1 REP Server High-Availability Software

The REP servers use Heartbeat for high-availability (see **heartbeat(8)** (type: **man heartbeat**) and <http://linux-ha.org/HeartbeatProgram/> for more information). Documentation resides in the `/usr/share/doc/heartbeat-1.2.3` directory.

#### Terminology

- **Cluster.** A group of computers that provide access to resources.
- **Node.** A single computer in the cluster. A node may have multiple central processing units (CPUs) and/or LAN interfaces. Each node may provide access to any and all cluster resources.
- **Resource.** A service or device that is managed by the cluster (e.g., an IP address, a daemon, a file system, or a set of cron jobs).
- **Resource Group.** A set of resources that are always swapped together as a unit. This is equivalent to the notion of “package” for HP MC/ServiceGuard or “service” for the Linux Red Hat Cluster Manager.

#### Configuration

The cluster configuration file `/etc/ha.d/ha.cf` defines nodes, heartbeat channels, and various failover parameters. Most parameters have been left at their default values for because there has been no reason to change them. Descriptions of some parameters of note follow.

- **Nice failback on.** This setting prevents resources from automatically failing over to the default host when it becomes available. The rationale behind this setting is that the failback should occur in a controlled manner. Automatic failback could cause unnecessary interruptions to applications that do not know or care whether a particular resource is on the default or backup node. Furthermore, the cause of the original failure may require investigation and repairs may be required before the default node is brought back into service. This option is required in order to allow network interface failures to induce a failover (see **ipfail plug-in** below).
- **bcast eth1.** Broadcast heartbeat messages on the eth1 interface. Eth1 interfaces to the private subnet for the cluster.
- **ucast eth0 <peer\_ip>.** Unicast heartbeat messages to peer on the eth0 interface. Eth0 interfaces to the site LAN. Having two cluster heartbeat interfaces ensures cluster integrity even if one of the interfaces goes down.

- **watchdog /dev/watchdog.** Reboot if we do not receive our own heartbeat messages within a minute. This option ensures that a node that has been cut off from the cluster due to a heartbeat network interface failure to relinquish its resources before another node takes them over.
- **node rp1-xxx rp2-xxx.** The list of nodes that comprise the cluster. Additional nodes may be added as required. Each of these nodes must be capable of providing access to any and all cluster resources.
- **ping router-xxx.** Treat router-xxx as a pseudo-cluster member. If a node cannot access router-xxx, it will query the other nodes to determine whether the **ping** node is down or the node's network interface has failed.
- **respawn hacluster /usr/lib/heartbeat/ipfail.** Run the **ipfail plug-in**. This plug-in will fail over any held resources when a node determines that its network interface has failed (due to the failure to reach a **ping** host). Note that **ipfail** requires the **nice\_failback** option.

The resource configuration file `/etc/ha.d/haresources` defines resource groups and preferred nodes. This configuration file must be identical on all nodes. A detailed description of the syntax for this file is contained in the header of the file.

### 18.3.2 REP Server Failover Scenarios

Cluster status monitoring is accomplished via the `/awips/ops/bin/hb_stat` utility script. With no arguments, the script reports the status of the heartbeat cluster daemons on each node and the owner/status of each resource group. In the example of sample output that follows, the heartbeat cluster daemons are up on both nodes, Resource Group 1 is running on rp2-tbdr, and Resource Group 2 is running on rp1-tbdr.

```
Heartbeat Status Monitor                               Feb 02 15:45:52
===== Member Status =====
Member      Status      IP address
-----
rp1-tbdr    Up          165.92.29.75
rp2-tbdr    Up          165.92.29.76

===== Service Status =====
Service     IPaddr      Cronfile    Owner       Start Time
-----
REPSvc1     165.92.29.77  REPCron1    rp2-tbdr    Jan 30 20:47:20
REPSvc2     165.92.29.78  REPCron2    rp1-tbdr    Jan 30 20:47:30
```

The cluster daemons log information and error messages to `/var/log/cluster`.

### Automatic Failover

A node will automatically take over a resource group if it cannot contact the owner of the resource group via either heartbeat channel within **deadtime** seconds (30 seconds). A



node will automatically give up a resource group to a peer if it cannot ping the router within **deadtime** seconds. If a node does not receive its own heartbeat message within a minute, it will reboot itself, thereby giving up any resource groups it may have been managing. Failover of resource groups based on the failure of a managed process is not implemented at this time; no managed processes have yet been defined.

### Manual Failover

Manual failover is provided via the `/awips/ops/bin/hb_swap` script. This script requests a resource group swap from the heartbeat cluster daemons. The first argument must be a resource unique to the resource group to be swapped as it appears in the **haresources** file (including any arguments). The entire resource group will be swapped, not just the resource specified. If that is not the desired result, the cluster is not configured correctly. If the node option is used, it must match the node name specified in the **ha.cf** and **haresources** files.

As an example, given the **haresources** file entries on site **tbd**r (a testbed),

```
rp1-tbdr IPaddr::165.92.29.77 REPSvc1 crontab::REPCron1
rp2-tbdr IPaddr::165.92.29.78 REPSvc2 crontab::REPCron2
```

To swap the first resource group to node `rp2-tbdr`, run any **one** of the following commands:

```
TYPE:      hb_swap IPaddr::165.92.29.77 rp2-tbdr
           or
```

```
TYPE:      hb_swap REPSvc1 rp2-tbdr
           or
```

```
TYPE:      hb_swap crontab::REPCron1 rp2-tbdr
```

If the node argument is omitted, the node to which the resource group is being given is deemed to be the local host. If **rsh** is not enabled, this is the way the script must be run. **rsh** is used to deliver the request message to the cluster daemon that is taking over. So, to perform the example swap without using **rsh**, the following command could be run on `rp2-tbdr`:

```
TYPE:      hb_swap REPSvc1
```

### 18.3.3 Managing the Heartbeat Cluster Service

The heartbeat service is configured to start automatically at Run Level 3 and may be started and stopped and started manually. This service may be managed using **chkconfig(8)**. Use the **/sbin/service** command to stop/start/restart and check the status of the heartbeat service.

```
TYPE:      /sbin/service heartbeat start
```

**TYPE:**        `/sbin/service heartbeat stop`  
**TYPE:**        `/sbin/service heartbeat restart`  
**TYPE:**        `/sbin/service heartbeat status`

#### 18.3.4 EDEX/IPVS, LDM Failovers

EDEX runs on dx3 and dx4. There is no “failover” as it is managed as a cluster. Both machines can accomplish all the tasks. If one machine goes down, then the other has to handle the full load, whereas otherwise they share the load. EDEX mostly communicates with qpid by reading messages off of it. However, it also receives connections from CAVE. This is where IPVS comes in. IPVS monitors the EDEX cluster, and “serves” connections to it. This means that CAVE connections are routed through IPVS onto one of the EDEX servers. If one of the servers, dx3 or dx4, is down, then IPVS would route all the connections to the only available node in the cluster. If they are both up, then it will try to keep an equal number of connections to each, to balance the load.

The EDEX and IPVS are managed through System V init scripts, for example, service edex\_camel start for EDEX and service pulse start for IPVS. IPVS currently runs on CPs.

LDM is managed through heartbeat. It will start and stop the ldm feed. By default it runs on cp1f.

#### 18.4 AWIPS II to AWIPS I Fallback

AWIPS II is designed to co-exist with the AWIPS I software that it is replacing. This includes the capability to switch between AWIPS I operation and AWIPS II operation. The intent is to allow a site – Weather Forecast Office, River Forecast Center, etc. – to revert to AWIPS I operation if significant problems occur in the operation of the AWIPS II software.

**NOTE:** The fallback should not be attempted without appropriate approval from a qualified ESA or ITO (see below) who initially installed the AWIPS II system and currently manages the AWIPS II software to run on AWIPS I.

**ESA:** The ESA serves as the local office point of contact for system changes that affect hardware, software, and communications infrastructure. The ESA is responsible for coordinating assigned EMRS maintenance requests with appropriate persons at the office, working with the MIC as appropriate. The ESA is responsible for reporting completion of an assigned EMRS maintenance request via the EMRS system.

**ITO:** The ITO serves as the local office point of contact for system changes that affect software (application, operational, database, and operating system) for which the ITO has been assigned or delegated responsibility by the MIC/HIC. The ITO is responsible for coordinating assigned EMRS maintenance requests with appropriate persons at the office, working with the MIC and the ESA as appropriate. The ITO is

responsible for reporting completion of an assigned EMRS maintenance request via the EMRS system.

Many of the operations required to switch between AWIPS I and AWIPS II operation are controlled by a single script: *rehost\_awips.sh*. *rehost\_awips.sh* is part of the AWIPS II installation package.

AWIPS II-to-AWIPS I fallback consists of a series of operations that back up the AWIPS II databases, switch from AWIPS II to AWIPS I operation, and import the previously backed-up AWIPS II databases. Scripts are provided for the first two steps; a manual procedure is provided for the third step.

The process of switching from AWIPS I to AWIPS II consists of a series of operations that back up the AWIPS I databases, switch from AWIPS I to AWIPS II operation, and import the previously backed-up AWIPS I databases. Scripts are provided for the first two steps; a manual procedure is provided for the third step.

#### 18.4.1 AWIPS I/AWIPS II Co-existence

The AWIPS II software is designed to co-exist<sup>1</sup> with the existing AWIPS I software. This co-existence is intended to minimize the impact to operations during the initial installation of the AWIPS II software, and allow the AWIPS II software installation and much of the initial setup to be performed while the existing – AWIPS I – software is in operation.

This design also provides a mechanism for reverting the system to AWIPS I operation if significant problems are encountered following the AWIPS II installation.

This installation design relies on three factors:

1. The AWIPS II software is installed into a separate file system, generally located at */awips2* on the affected servers and workstations.
2. A switchover script, *rehost\_awips.sh*, is provided as part of the AWIPS II installation package. This script provides semi-automated switching between AWIPS I and AWIPS II operations.
3. When similar functionality exists between AWIPS I and AWIPS II, soft links using the AWIPS I names are used to point the user to the correct executable for the current operational mode (AWIPS I or AWIPS II).

Prior to installation, the AWIPS II installation package should be staged on a network-accessible file system. The location of the staging area is referred to in this module as **<AWIPS2\_INSTALL\_DIR>**.

---

<sup>1</sup> “Co-exist” means that both software packages can be installed on the same system. Only one package can be used at a time, however.

It is important to realize, however, that while both AWIPS I and AWIPS II can be installed, only one of the software packages may be in operation at any one time.

**NOTE:** The operational modes are referred to as follows:

- *AWIPS I operational mode* means that the system is running AWIPS I software. This may also be referenced as *AWIPS I mode*.
- *AWIPS II operational mode* means that the system is running AWIPS II software and rehosted applications. This may also be referenced as *AWIPS II mode*.

It is also important to recognize that AWIPS II stores much of its data differently from AWIPS I, using PostgreSQL databases and HDF5 files where AWIPS I used NetCDF files.

### 18.4.2 Swapping Procedures

In the event that your site needs to swap operations from AWIPS I to AWIPS II mode, the latest procedures will be sent to your office by the appropriate NWS or NCF personnel.

The procedures boil down to a few general steps:

1. Backing up the postgres database and vtec information.
2. Running the rehost script to swap operations to the other mode.
3. Importing the databases and vtec information.
4. Verifying the new operations.

**\*\* CAUTION \*\***

Swapping operational modes from AWIPS II to AWIPS I requires that all server software be shut down. As a result, all client software must also be shut down during the swap.

### 18.4.3 Limitations on System Swapping

When swapping between AWIPS I mode and AWIPS II mode, certain limitations must be considered.

1. The actual swap requires approximately an hour. Much of this time is devoted to exporting and importing the common databases, and running the swap script. During most of the switchover, no data is being ingested.
2. AWIPS II stores much of its decoded data in a different format than AWIPS I. As a result, there is no practical way to import much of the decoded data from AWIPS I into AWIPS II and vice versa.

3. Even though both AWIPS I and AWIPS II use the text database fxatext, the table structure differs. As a result, there is no practical way to import decoded text from AWIPS I into AWIPS II and vice versa.

Following the swap between AWIPS I and AWIPS II, standard data recovery procedures can be used to backfill missing data. In most cases, there will be a delay in data availability as new data is being ingested.

# **Chapter 19**

## **System Backup and Recovery Procedures**

## Chapter 19. System Backup and Recovery Procedures

### Table of Contents

	<i>Page</i>
19.1 DX NAS Backups .....	1
19.2 Other Backups .....	2
19.2.1 NAS Weekly Backup Strategy .....	2
19.3 REP/NS1 Backup (RFCs Only) .....	3
19.4 Recovery Procedures .....	3
19.4.1 Volume Table .....	3
19.4.2 How To Recover a Single File .....	5
19.4.3 How to Recover an Entire Volume .....	5
19.4.4 How to Recover an Entire Volume to a Temporary Location .....	6
19.4.5 Other Helpful Commands .....	7

### List of Tables

Table 19.2-1. /data/fxa Directories for Backup .....	2
------------------------------------------------------	---

Backups include a mix of cron-generated backups and snapshots that are taken using Linux system utilities. Backups should be transparent to the sites except that sites will need to swap out some tapes on a weekly basis. Because sites may occasionally want to keep a tape, it is recommended that the sites have more than two tapes on hand so that tapes are still available for rotation even when a site wants to keep a tape.

### 19.1 DX NAS Backups

The weekly Network Attached Storage (NAS) backup is controlled by a root cron on the Archive Server (AX). This weekly backup (*nas\_backup\_weekly*) executes Mondays at 0310Z and backs up NAS volumes to an external tape drive connected to the AX. The weekly backup dumps all of the file systems created on the NAS to tape (i.e., the entire NAS). Another cron launches a daily backup (*nas\_backup\_daily*) at 0210Z and merely creates a tar archive file in /data/fxa/DAILY\_BACKUP. This cron runs in conjunction with the a2dx1apps package. Tapes used for the weekly backups should be rotated on a weekly basis, and it is recommended that sites purchase additional blank tapes so they can keep a tape (i.e., move it out of the rotation) if needed or desired.

#### Checkpoint Backups

Checkpoints occur weekly at 0000Z. The system preserves four weekly snapshots.

**NOTE:** With the introduction of the Sun StorageTek 5320, nightly checkpoints are also taken.

Snapshot is enabled for the following file systems:

1. /home
2. /awips/adapt
3. /awips/gis
4. /awips/dev
5. /data/local
6. aiidata

aiidata is a directory on the NAS. It is located at nas1:/aiidata. Various systems have mounts to all or part of aiidata. Generally, these mounts are at /awips2/edex/data or a subdirectory. On DX3/4, nas1:/aiidata is mounted at /awips2/edex/data. On PX1/2, nas1:/aiidata is mounted on /awips2/edex/data. On the LX and XT workstations, nas1:/aiidata/share is mounted on /awips2/edex/data/share.

**NOTE:** The /data/local snapshot should be monitored for dynamic “live” data.

Checkpoints should not be done on partitions with a lot of dynamic files activity, such as /data/fxa. The /awips/hydroapps file system could not be included in the snapshot strategy either, due to the mix of static and dynamic data within the same file system.



## 19.2 Other Backups

A daily online backup will **tar** key directories that are not within the partitions that have checkpoints configured. The results are saved in the **/data/fxa/DAILY\_BACKUP** directory.

Table 19.2-1 lists the directories that are backed up by the NAS daily backup, including the **/awips/hydroapps** file system backups. You can view the daily NAS daily backup log at **/data/logs/daily\_backup.log** on the server that currently hosts the **dx1apps** package.

**Table 19.2-1. /data/fxa Directories for Backup**

/data/fxa/archive
/data/fxa/customFiles
/data/fxa/rps-lists
/data/fxa/scripts
/data/fxa/siteConfig
/data/fxa/userPrefs
/data/fxa/workFiles
<b>/awips/hydroapps Files/ Directories for OHD-related Backup</b>
Backing up /awips/hydroapps/.Apps_defaults...
Backing up /awips/hydroapps/.Apps_defaults.orig...
Backing up /awips/hydroapps/.Apps_defaults_radclim...
Backing up /awips/hydroapps/.Apps_defaults_site...
Backing up /awips/hydroapps/.Apps_defaults_site-AWIPS1...
Backing up /awips/hydroapps/.Apps_defaults_site-AWIPS2...
Backing up /awips/hydroapps/.Apps_defaults_site-AWIPS2.OAX...
Backing up /awips/hydroapps/.Apps_defaults_site-AWIPS2.OUN...
Backing up /awips/hydroapps/.Apps_defaults_site-AWIPS2.box..
Backing up /awips/hydroapps/lx/geo_data...
Backing up /awips/hydroapps/precip_proc/local/data/app...
Backing up /awips/hydroapps/whfs/local/data/app...
Backing up /awips/hydroapps/whfs/local/data/geo...

### 19.2.1 NAS Weekly Backup Strategy

A cron is initiated from the Archive Server (AX) on a weekly basis which performs a backup to tape of all NAS volumes. The LTO-II tape drive is hooked to the Archive Server via an external SCSI cable.

The `/awips/ops/bin/nas_weekly_backup` script performs the work of the backup. This script was modified for the deployment of the StorageTek NAS to run only from the AX and utilizes the `tar` command to write the entire contents of the NAS to tape. Each NAS share (or file volume) will reside on one tape “file.” A tape file is merely a pointer to the start of a new data set. To eliminate the problems with backing up a live file system, a temporary checkpoint is created for each file volume prior to the backup and used for creating the backup. This checkpoint is then removed at the end of the backup.

The script will automatically rewind and eject the tape at the end of each backup. Sites are responsible for rotating tapes when they arrive *at the office Monday morning*.

### 19.3 *REP/NSI Backup (RFCs Only)*

No script was provided to the RFCs to back up their LTO-II. However, the following checkpoints are taken of the `/awips/rep` file system:

- **Nightly.** Once a day at 0000Z for 7 days (then tapes should be rotated or the tape will be overwritten)
- **Weekly.** Once a week at 0000Z for 4 weeks (then tapes should be rotated or the tape will be overwritten).

These snapshots are conservative and may not be possible at some RFCs. Because River Ensemble Processor (REP) requirements do not state how the device is to be used, the snapshots may need to be adjusted on a per-site basis depending on file system usage. Sites with very dynamic data sets will need to reduce the frequency or quantity of snapshots.

**NOTE:** This backup strategy will not change with the replacement of the NetApp FAS250, except that the snapshots will be named checkpoints.

## 19.4 *Recovery Procedures*

### 19.4.1 *Volume Table*

In order to recover a file or an entire volume, you must consult the following table:

Volume No.	Volume
0	dataGFE
1	dataX400
2	awipsADAPT
3	DSshared
4	dataADAPT
5	awipsGIS
6	awipsDEV
7	awipsHOME
8	dataLOCAL
9	awipsHYDRO
10	awipsGFESuite
11	dataFXA
12	GFESuite2
13	Aiidata
14	Qpid
15	Localapps

This table is derived from a variable called 'arBackupList' in this file:  
 ax:/awips/ops/bin/nas\_backup\_weekly

Here is the variable as included in the file.

```

if [ `cat /awips/Release_ID` == AWIPSII ]; then
    echo -en "\n\n\t[INFO]: Setting _arBackupList to
include the AWIPSII partitions.\n"

    _arBackupList=( "/tmp/data/GFE"
"/tmp/data/x400" "/tmp/awips/adapt" "/tmp/DS_shared"
"/tmp/data/adapt" "/tmp/awips/gis"

"/tmp/awips/dev"
"/tmp/home" "/tmp/data/local" "/tmp/awips/hydroapps"
"/tmp/awips/GFESuite" "/tmp/data/fxa"

"/tmp/awips2/GFESuite"
"/tmp/awips2/edex/data" "/tmp/awips2/qpid/messageStore"
"/tmp/localapps" )

else
    echo -en "\n\n\t[INFO]: Setting _arBackupList to
only include the AWIPSI partitions.\n"

    _arBackupList=( "/tmp/data/GFE"
"/tmp/data/x400" "/tmp/awips/adapt" "/tmp/DS_shared"
"/tmp/data/adapt" "/tmp/awips/gis"

"/tmp/awips/dev"
"/tmp/home" "/tmp/data/local" "/tmp/awips/hydroapps"
"/tmp/awips/GFESuite" "/tmp/data/fxa" )

fi

```

### 19.4.2 How To Recover a Single File

Assume that you need to recover this file:

```
/data/fxa/engDict
```

The six steps required to recover the file follow.

1. Log onto AX as the root user

```
ssh root@ax
```

2. Identify the filesystem upon which the file is located.

The volume on which the file must be located. To do this, type the following commands:

```
cd /data/fxa
df -h .
```

You will see this output:

Filesystem	Size used	Avail	Use%	Mounted on
nas1:/dataFXA	500G 424G	77G	85%	/data/fxa

This output tells us that the file to be recovered (engDict) is located on the dataFXA volume. Consulting the Volume Table, we see that dataFXA is volume number 11.

3. Eject the tape and place a tape in that you know contains the file you need to recover.
4. Rewind the tape to the beginning (commands issued from the AX as user root):

```
mt -f nst0 rewind
```

5. Forward the tape to the beginning of volume 11 (dataFXA):

```
mt -f nst0 fsf 11"
```

6. Restore the file:

```
tar -xzvf /dev/nst0 -C /data/fxa engDict
```

This completes the steps required to recover the file.

### 19.4.3 How to Recover an Entire Volume

This procedure will restore an entire volume, overwriting all files with data from the backup tape. If you do not wish to overwrite all of your data, skip to the next section (19.4.4, "How to Recover an Entire Volume to a Temporary Location").

1. Identify the volume you would like to restore.

[In this example, we will restore volume 6 (awipsDEV), which is mounted on /awips/dev.]

2. Insert a tape into the backup tape drive that contains the volume you would like to restore.

3. Rewind the tape to the beginning (commands issued from the AX as user root).

```
mt -f nst0 rewind
```

4. Forward to the beginning of volume 6 (awipsDEV).

```
mt -f nst0 fsf 6
```

5. Type the following command to restore the files in this volume.

```
tar -xzvf /dev/nst0a -C /awips/dev
```

#### 19.4.4 How to Recover an Entire Volume to a Temporary Location

This procedure will copy an entire volume from backup tape to a temporary location on disk. This is useful if you need to choose an array of files to restore without overwriting existing data.

1. Identify the volume to restore. In this example we will restore to a temporary location the dataLOCALvolume (volume number 8).
2. Identify the size of the volume you need to restore.

```
df -h /data/local
```

You should see output similar to this:

Filesystem	Size	Used	Avail	Use%	Mounted on
nas1:/dataLOCAL	150G	51G	100G	34%	/data/local

There is no way to tell how large the volume is on the tape device, so we have to assume that the size of the data on tape is relatively the same as the size existing on disk (after all, it is a backup). So, because the "Use%" is less than 50%, this allows us to assume that we have enough space to make a complete copy of the backup tape's data\_local volume inside /data/local.

3. Create a temporary directory to hold our restored files on /data/local

```
cd /data/local
mkdir RESTORED
```

4. Log into the AX as user root

```
ssh root@ax
```

5. Rewind the tape.

```
mt -f nst0 rewind
```

6. Step the tape forward to our desired volume (volume 8, dataLOCAL).

```
mt -f nst0 fsf 8
```

7. Restore the files to our RESTORED directory

```
tar -xzvf /dev/nst0 -C /data/local/RESTORED
```

**Note:** Suppose there is not enough space to put your RESTORED directory in /data/local/ ... You could restore the data\_local volume to //data/fxa/RESTORED if there is enough space in the dataFXA volume.

### 19.4.5 Other Helpful Commands

The status command tells you what volume and block you are currently located at. You always need to be at block 0 of the volume you are concerned with (e.g., volume 9 block 0). If you are not, you need to rewind the tape and step it forward to the volume point before restoring.

The status command is:

```
ssh ax "mt -f nst0 status"
```

If you are not sure if the file you need is on the volume, you can list them using tar -tzf /dev/nst0

```
tar -tzf /dev/nst0 engDict
```

The preceding command will list the file if it is present or tell you that it is not found.

Use this command to retrieve a list of ALL the files in the backup volume:

```
tar -tzf /dev/nst0
```

## **Chapter 20**

### **System Console**

## Chapter 20. System Console

### List of Tables

	<i>Page</i>
Table 20-1. ATS1 Port and Logical Port Assignments.....	3
Table 20-2. ATS2 Port and Logical Port Assignments.....	4
Table 20-3. LTS1 Port and Logical Port Assignments .....	5



The Tripp Lite B096-048 terminal server connects the console ports for the site hardware to the system console and the server private LAN. These connections provide the Monitor and Control console functionality either via the system console or via a private LAN SSH session. The B096-048 terminal server provides the NCF remote system console functionality via the M&Cmodem connections, private LAN SSH sessions, or the WAN.

The local system console is an HP Thin Client, and can be used to monitor either the AWIPS or LDAD systems by switching to the A or B position of the A/B switch box.

- There is one B096-048 (two at an RFC) for AWIPS and one B096-032 for LDAD. The system console (HP Thin Client) can be directed to either B096 Terminal Server, via an A/B switch box.
- To access either Terminal Server, you must first log into the Thin Client and then double-click on the AWIPS profile in TeemTalk to open the terminal emulating application.
- If an AWIPS or LDAD connection cannot be established, at the Terminal Server's shell prompt, as root, issue the following:
 

```
ps grep [####]
```

 (where '####' is the logical port number of the inaccessible device)
 

```
kill -9 [pid]
```

 (where 'pid' is the process ID of the session accessing the device).
- Console access to the devices can be acquired from a menu or directly by SSH t, if the logical port number is known.

To view a list of devices from a menu:

On AWIPS Terminal Server 1/2 (ATS1/2), issue the following:

```
pmsHELL
```

On LDAD Terminal Server 1 (LTS1), issue the following:

```
pmsHELL
```

To access a device directly using the logical port number,

```
ssh ats1 -p7001
```

The B096-048 terminal server is used to access all the server and workstation console ports in the beginning and at the end of the process. Additionally, miscellaneous devices connect through the B096-048 including the switches, routers, VIR, and CPSBNs.

The AWIPS B096-048 ATS1 menu follows.

```
# pmsHELL
```

1: DX1	2: DX2	3: DX3	4: DX4
5: PX1	6: PX2	7: AX	8: NAS1
9: NAS2	10: OPEN	11: PSW	12: LDAD DMZ
13: OPEN	14: OPEN	15: HSW1	16: HSW2
17: FW1	18: FW2	19: SW_PNL	20: ADTRAN1
21: LX1	22: LX2	23: LX3	24: LX4
25: LX5	26: LX6	27: OPEN	28: OPEN
29: OPEN	30: OPEN	31: XT1	32: XT2
33: XT3	34: XT4	35: XT5	36: XT6
37: CPSBN1	38: CPSBN2	39: OOB	40: DAS1
41: DAS2	42: OPEN	43: OPEN	44: OPEN
45: OPEN	46: OPEN	47: OPEN	48: OPEN

Connect to port >

The LDAD B096-032 LTS1 menu follows.

# pmshell			
1: 7E1	2: 8N1	5: Port 5	7: Port 7
8: Port 8	9: Port 9	10: Port 10	11: Port 11
12: Port 12	13: Port 13	14: Port 14	15: Port 15
16: Port 16	17: Port 17	18: Port 18	19: Port 19
20: Port 20	21: Port 21	22: Port 22	23: Port 23
24: Port 24	25: Port 25	26: Port 26	27: Port 27
28: VIR	29: LLSW	30: Port 30	31: LS2
32: LS3			

Connect to port >

Note that B096-048 does not have a “Login Screen.” Instead, it has just a plain text prompt asking for a username and password as shown below.

**ats1 login:**

**Password:**

From the Tripp Lite Terminal Server, issue the following key sequence to disconnect from a console connection,

**^ . (Shift 6, then dot)**

ATS1 Port and Logical Port Assignments for ATS1 follow in Table 20-1.

**Table 20-1. ATS1 Port and Logical Port Assignments**

Device Name	Port Num	Logical Port
DX1	1	7001
DX2	2	7002
DX3	3	7003
DX4	4	7004
PX1	5	7005
PX2	6	7006
AX	7	7007
NAS1	8	7008
OPEN	9	7009
OPEN	10	7010
PSW	11	7011
DMZ	12	7012
OPEN	13	7013
OPEN	14	7014
HSW1	15	7015
HSW2	16	7016
FW1	17	7017
FW2	18	7018
VIR	19	7019
OPEN	20	7020
LX1	21	7021
LX2	22	7022
LX3	23	7023
LX4	24	7024
LX5	25	7025
LX6	26	7026
OPEN	27	7027
OPEN	28	7028
OPEN	29	7029
OPEN	30	7030
XT1	31	7031
XT2	32	7032
XT3	33	7033
XT4	34	7034
XT5	35	7035
XT6	36	7036
CPSBN1	37	7037
CPSBN2	38	7038
M&C	39	7039
DX1-DAS	40	7040
DX2-DAS	41	7041

Device Name	Port Num	Logical Port
RTR3*	42	7042
PX3**	43	7043
PX4**	44	7044
OPEN	45	7045
OPEN	46	7046
OPEN	47	7047
OPEN	48	7048
* ACR – Router3                      ** AFC – PX3/PX4		

ATS2 Port and Logical Port Assignments for ATS1 follow in Table 20-2.

**Table 20-2. ATS2 Port and Logical Port Assignments**

Device Name	Port Num	Logical Port
OPEN	1	7001
OPEN	2	7002
OPEN	3	7003
OPEN	4	7004
OPEN	5	7005
OPEN	6	7006
OPEN	7	7007
RP1	8	7008
RP2	9	7009
OPEN	10	7010
OPEN	11	7011
NS1	12	7012
OPEN	13	7013
OPEN	14	7014
OPEN	15	7015
OPEN	16	7016
OPEN	17	7017
OPEN	18	7018
OPEN	19	7019
OPEN	20	7020
LX7	21	7021
LX8	22	7022
LX9	23	7023
LXA	24	7024
LXB	25	7025
LXC	26	7026
LXD	27	7027
OPEN	28	7028
OPEN	29	7029
OPEN	30	7030

Device Name	Port Num	Logical Port
XT7	31	7031
XT8	32	7032
XT9	33	7033
XTA	34	7034
XTB	35	7035
XTC	36	7036
XTD	37	7037
OPEN	38	7038
OPEN	39	7039
OPEN	40	7040
OPEN	41	7041
OPEN	42	7042
OPEN	43	7043
OPEN	44	7044
OPEN	45	7045
OPEN	46	7046
OPEN	47	7047
OPEN	48	7048

LTS1 Port and Logical Port Assignments for ATS1 follow in Table 20-3.

**Table 20-3. LTS1 Port and Logical Port Assignments**

Device / Interface Type	Port Num	Logical Port
7e1out	1	7001
8n1out	2	7002
pppInteractive	3	RRS IP Address
pppInteractive	4	RRS IP Address
cspord	5	5005
pppInteractive	6	RRS IP Address
cspord	7	5007
cspord	8	5008
cspord	9	5009
cspord	10	5010
cspord	11	5011
cspord	12	5012
cspord	13	5013
FAX	14	5014
cspord	15	5015
cspord	16	5016
cspord	17	5017
cspord	18	5018
cspord	19	5019

Device / Interface Type	Port Num	Logical Port
csportd	20	5020
csportd	21	5021
csportd	22	5022
csportd	23	5023
csportd	24	5024
csportd	25	5025
csportd	26	5026
csportd	27	5027
VIR	28	7028
LLSW	29	7029
OPEN	30	7030
LS2	31	7031
LS3	32	7032

**Chapter 21**  
**System Shutdown and Startup**  
**Procedures**

## Chapter 21. System Shutdown and Startup Procedures

### Table of Contents

	<i>Page</i>
21.1 System Shutdown Procedures .....	1
21.2 AWIPS II System Startup Procedures.....	8
21.3 Verification of System Startup While Running AWIPS II Configuration.....	11
21.4 AWIPS II Checklist.....	16
21.5 LDM Ingest Checklist.....	18



As with all complex computer systems, a prescribed order of steps must be completed to shut down or restart AWIPS. It is necessary to follow this process in order to preserve the integrity of the data files and the safe termination of any hung or running processes.

A complete reboot of the system is not usually required, but if it is, the system manager must perform the AWIPS shutdown and restart.

This chapter includes shutdown and startup procedures for AWIPS II configuration only.

As noted in Chapter 2, AWIPS System Architecture, some dependencies exist within the AWIPS II systems. These dependencies dictate the best order for shutting down software and hardware, and are briefly described here:

- The HDF5 repository and postgreSQL persistence are served over a block-based Fibre Channel (FC) protocol implemented currently via the Direct Attached Storage (DAS) at WFOs and RFCs connected via FC to DX1 and DX2. At NCEP centers the same is achieved via the NetApp filer device.
- Data ingest processes such as the AWIPS Local Data Manager, Radar Configuration Manager (RCM), and Local Data Acquisition and Dissemination (LDAD) rehosted applications write raw data into the /data\_store mounted on the hosts off the NAS (NAS2).
- Environmental Data Exchange (EDEX) reads and processes raw data files from the /data\_store mount.
- EDEX is dependent on both Queue Processor Interface Daemon (QPID) and the postgreSQL database engine running before it starts.
- AWIPS II site data configuration and localization files are stored on an NFS protocol mount physically hosted on the NAS device.

**NOTE:** You must be logged in as root to perform system shutdown and startup. Please notify the Network Control Facility at 301.713.9344 before shutting down any part of the system. This will minimize any miscommunication when the NCF begins getting ITO alarms.

## 21.1 System Shutdown Procedures

If a user is already logged into an LX or XT workstation (i.e., an X-session is running) go to the KMenu (the KMenu is indicated by the RedHat “shadow man” icon on the bottom of the panel) and left-click and select Logout. When the logout menu appears, select TURN OFF COMPUTER. If the workstation is at a GDM login prompt, select Actions from the GDM menu and Shut Down. When prompted to choose Cancel or Shut Down, select Shut Down. If you want to use a command line (manual) shutdown, then log in to a workstation as user root. Open a Terminal window. On each workstation LX, and XT,

**TYPE:** `shutdown -h 0`

- The workstations will power off automatically once the shutdown is complete; this is indicated by the LED either above or back-lighting the power-supply switch (located on the front of the workstation chassis) turning dark.
- Power off the LX, XT, and monitors when the monitor displays all black.

Complete the following steps to perform an orderly shutdown of an AWIPS II system

1. [ RFC Only ] – Shut down rp2apps.

**ssh rp2f hostname**

Use return hostname in the following command.

**Enter:** `ssh << hostname >>`

**Enter:** `hb_halt rp2apps`

2. [ RFC Only ] – Shut down rp1apps.

**ssh rp1f hostname**

Use return hostname in the following command.

**Enter:** `ssh << hostname >>`

**Enter:** `hb_halt rp1apps`

3. [ RFC Only ] – Shut down RP1 and RP2.

**Enter:** `ssh rp2`

**Enter:** `shutdown -h now && exit`

**Enter:** `ssh rp1`

**Enter:** `shutdown -h now && exit`

4. Log in and shut down the AX.

**Enter:** `ssh ax`

**Enter:** `service postgresql stop` [ RFC Only]

**Enter:** `shutdown -h now && exit`

5. Stop a2px2apps.

The a2px2apps runs peripheral system-level and LDAD application software. The LDAD software in particular is dependent upon having QPID running and the /data\_store mount read/write accessible. The EDEX manual endpoint /awips2/edex/data/manual is also a prerequisite for the functionality of the

applications managed by the resource group `a2px2apps`. Other than LDAD external processes, no other system-wide dependencies exist **on** the `a2px2apps` running.

**Enter:**        `ssh px2f hostname`

Get the hostname from the previous step and use in the next step.

**Enter:**        `ssh <hostname>`

**Enter:**        `hb_halt a2px2apps`

**Enter:**        `hb_stat`            [Ensure the package has stopped.]

**Enter:**        `exit`                [Back to dx1 shell.]

#### 6. Stop `a2px1apps`.

The `a2px1apps` also runs peripheral system-level processes as well as rehosted application software such as MSAS, LAPS, and FSI. The rehosted software in particular is dependent upon having QPID running and the `/data_store` mount read/write accessible. The EDEX manual endpoint `/awips2/edex/data/manual` is also a prerequisite for functionality of the applications managed by the resource group `a2px1apps`. Other than the rehosted processes, no other system-wide dependencies exist **on** the `a2px1apps` running.

**Enter:**        `ssh px1f hostname`

Get the hostname from the previous step and use in the next step.

**Enter:**        `ssh <hostname>`

**Enter:**        `hb_halt a2px1apps`

**Enter:**        `hb_stat`            [Ensure the package has stopped.]

**Enter:**        `exit`                [Back to dx1 shell.]

#### 7. Shut down LS2 and LS3 servers.

Because the LDAD Server (LS) software is only dependent on the `a2px2apps` package, we can safely shut these down, now that the Linux Preprocessor (PX) server software has been shut down.

**Enter:**        `ssh ls3`

**Enter:**        `shutdown -h now && exit`

(This will stop all software.)

Connect to the LS2 via ssh and shut down the server.

**Enter:**        `ssh ls2`

**Enter:**        `shutdown -h now && exit`

(This will stop all software.)

## 8. Stop EDEX on dx4 (and dx5, dx6 at NCEP Centers)

```
Enter:      ssh dx4
Enter:      service edex_camel stop
Enter:      ps -fu awips      [Ensure processes are no longer running.]
Enter:      exit              [Return to dx1 shell.]
```

## 9. Stop RCM.

```
Enter:      ssh dx1f
Enter:      service edex_rcm stop
Enter:      ps -wef|grep rcm  [Ensure process is no longer running.]
Enter:      exit
```

## 10. Stop a2dx2apps.

```
Enter:      ssh dx2f hostname
```

Get the hostname from the previous step and use in the next step.

```
Enter:      ssh <hostname>
Enter:      hb_halt a2dx2apps
Enter:      hb_stat          [Ensure the package has stopped.]
Enter:      exit
```

## 11. Stop EDEX on dx3

```
Enter:      ssh dx3
Enter:      service edex_camel stop
Enter:      ps -fu awips      [Ensure processes are no longer running.]
Enter:      exit              [Return to dx1 shell.]
```

## 12. Stop LDM on cpsbn1 and cpsbn2 and a2cplapps on the host running the package.

```
Enter:      ssh cplf hostname
```

Use the return value from the above command in place of the word \$HOST below.

```
Enter:      ssh $HOST
Enter:      hb_halt a2cplapps
Enter:      hb_stat          [Ensure the package has stopped.]
Enter:      exit
Enter:      ssh cpsbn1
```

```

Enter:      service ldmcp stop
Enter:      ps -fu ldm          [Ensure the processes have stopped.]
Enter:      exit
Enter:      ssh cpsbn2
Enter:      service ldmcp stop
Enter:      ps -fu ldm          [Ensure the processes have stopped.]
Enter:      exit

```

13. If this site has remote CPs (GUM, HFO, PBP and VRH), shut down qpid and pulse on px1.

```

Enter:      ssh px1
Enter:      service pulse stop
Enter:      ps -wef|grep pulse  [Ensure the processes have stopped.]
Enter:      service qpidd stop
Enter:      ps -fu awips        [Ensure the processes have stopped.]

```

14. Stop a2dx1apps.

Nothing left running relies on the PostgreSQL database engine running, so it is safe to stop all software running with the package.

```

Enter:      ssh dx1f hostname

```

Get the hostname from the previous step and use it in the next step.

```

Enter:      ssh <hostname>
Enter:      hb_halt a2dx1apps
Enter:      hb_stat              [Ensure the package has stopped.]
Enter:      exit

```

15. Shut down CPSBN1, CPSBN2, DX1, DX2, DX3, DX4, PX1, PX2.

Connect to cpsbn2 via the System Console

```

Enter:      shutdown -h now

```

Connect to cpsbn1 via the System Console

```

Enter:      shutdown -h now

```

Connect to px2 via the System Console

```

Enter:      shutdown -h now

```

Connect to px1 via the System Console

**Enter:**        **shutdown -h now**

Connect to dx4 via the System Console

**Enter:**        **shutdown -h now**

Connect to dx3 via the System Console

**Enter:**        **shutdown -h now**

Connect to dx2 via the System Console

**Enter:**        **shutdown -h now**

Connect to dx1 via the System Console

**Enter:**        **shutdown -h now**

**At NCEP Centers**, also shut down the DX5 but keep the DX6 up until Step 16 is completed.

#### 16. Shut down NAS.

Connect to the nas via the System Console

**Enter:**        **halt -f**

#### **NCEP Centers ONLY:**

Connect via a shell originated on DX6, which was left up in the previous step, e.g., use the console server to connect to DX6 and login as root. Issue the following commands from the connection.

From a shell prompt on DX6 issue:

**Enter:**        **umount -t nfs**

Once a command prompt returns:

**Enter:**        **ssh nas1**

**Enter:**        **halt -f 0**

At this point, shut down the clustered controller partner **nas2**:

**Enter:**        **ssh nas2** (after exiting back to a DX6 shell prompt)

**Enter:**        **halt -f 0**

Note that the '-f' flag prevents failover of the clustered resources from nas1/nas2.

Now it is safe to shut down the DX6 from the console connection issue **shutdown -h 0**

#### 17. Shut down DAS through the system console. **Note:** This must be done by completing the dx2-das head first, followed by the dx1-das.

**Enter:**        **halt -f**

**NCEP Centers:** The NCEP Centers do not have a separate DAS device; the DAS/NAS functionality at a WFO/RFC is combined into the NetApp filer.

18. Power off the printers.
19. Verify that power has been shut down to the racks and the following devices:
  - All 4-port hubs (Phubs) and 5-port switches
  - All HP 24-port switches
  - All VIR communication switch panels
  - Modem nest
  - Routers
  - Terminal Server
  - ADTRAN
  - Channel Service Unit / Digital Service Unit (CSU/DSU)
  - System console
  - Plaintree LAN switches
  - Power Strips
  - DVB receivers
  - Direct-Attached Storage (DAS).

**Note:** The following steps are included here as a quick reference for the Linux Workstation and X-Terminal Manual Shutdown and Startup.

1. On the middle screen of the three-headed Linux workstation, click on the **RedHat “shadowman”** icon on the tool bar.
2. **Select: Logout**
3. After the windows have closed and you are logged out, on the GDM login GUI:
  - Select:           Actions**
  - Select:           Shut Down**
4. Select **Y** when prompted about whether you want to halt the workstation.

**NOTE:** The Linux workstation will take several minutes to halt. You can follow its shutdown on the Cyclades Terminal Server.

5. The workstation should power itself off unless a problem is encountered. If it does not power off, hold down the power button until the power light goes out. (The network activity light will stay on.) Wait a moment, and then power the CPU on again.

When the GDM login screen displays, the workstation is ready for use.

## 21.2 AWIPS II System Startup Procedures

Complete the following steps to perform an orderly startup of an AWIPS II system.

1. Verify that power has been applied to the racks and the following devices:
  - All 4-port hubs (Phubs) and 5-port switches
  - All HP 24-port switches
  - All VIR communication switch panels
  - Modem nest
  - Routers
  - Terminal server
  - ADTRAN
  - CSU/DSU
  - System console
  - Power Strips
  - DVB receivers
  - Direct-Attached Storage (DAS)
2. Verify that the following conditions are met before proceeding:
  - NAS is powered on and up.
  - All switch settings on each VIR communication switch panel are powered on and set to A.
3. Power on the HP Thin Client (if it is not already powered on) and login as user root.
4. On the HP Thin Client, if no menu is displayed while being logged into ATS1/2, enter **ts\_menu** to get the ATS menu prompt.
5. Power (or cycle power) to ETO tape drive and FCBR fiber bridge.
6. Power on the DAS (NetApp FAS2020c direct-attached storage device).  
**NCEP ONLY:** Power up the NAS1/2 (FAS3160A) NetApp Filer
7. Power on the CPs (CPSBNs).
  - a. Verify that the CPSBN1 is accessible.

**TYPE:**        **ssh cpsbn1-<siteID>**
    - Where <siteID> is the site identifier

**TYPE:**        **exit**
  - b. Verify that the CPSBN2 is accessible.

**TYPE:**        **ssh cpsbn2-<siteID>**
    - Where <siteID> is the site identifier



**TYPE:**        `exit`

8. Power on DX1.
9. Ensure the DX1 server boots, and starts the `a2dx1apps` package.

Connect to the dx1 via the System Console and log in as root once booted

**Enter:**        `hb_stat`

If the package is NOT running, perform the following two steps:

**Enter:**        `hb_run a2dx1apps`

**Enter:**        `hb_stat`                    [Check for package run]

10. If not already running, start `a2cp1apps`, and QPID on CPSBN1. Then verify that they are accessible and that software is running. This is necessary because most processes have a dependency on QPID, but the processes running on the CPSBN do not depend on any other process or mount to function properly.

**Note: If site with remote CPs, then power up px1 at this time and start up pulse and qpuid as indicated below.**

Connect to cpsbn1 via the System Console

Check to see if `a2cp1apps` is running.

**Enter:**        `hb_stat`

**Enter:**        `tail -f /var/log/cluster`

If the package fails to start after a few minutes, force the package start.

**Enter:**        `hb_run a2cp1apps`

**Enter:**        `hb_stat`                    [Check for package running.]

Sites with remote CPs:

Connect to cpsbn1 via the System Console

Check if the LDM, QPID and pulse processes are running

**Enter:**        `ps -fu ldm`

**Enter:**        `ps -fu awips`

**Enter:**        `ps -wef|grep pulse`

If the processes are NOT running, perform the following two steps:

**Enter:**        `service ldmcp start`

**Enter:**        `ps -fu ldm`                    [Check for processes.]

If QPID is not running, then perform the following two steps:

```

Enter:    service qpidd start
Enter:    ps -fu awips           [Check for qpidd.]
Enter:    ps -wef|grep pulse

```

If IPVS (pulse) is not running perform following two steps:

```

Enter:    service pulse start
Enter:    ps -wef|grep pulse     [Check for pulse]

```

Disconnect from cpsbn1.

Log into CPSBN2 and check to see if the LDM is running. If it is not running, use the above command to start the software before exiting the ssh session.

```

Enter:    ssh cpsbn2
Enter:    ps -fu ldm
Enter:    ps -wef|grep dvbs | grep -v grep
Enter:    exit

```

11. Power on the remaining servers (DX2, DX3, DX4, PX1, PX2, PX3, PX4, AX, LS3, LS2, RP1, and RP2).
12. Check for EDEX and start on DX3 if it is not already running.

Connect to the dx3 via the System Console and log in as root once booted

```

Enter:    ps -fu awips           [Make sure no processes are running.]
Enter:    service edex_camel start
Enter:    service edex_camel status
   [Make sure all processes show
   running.]
Enter:    ps -fu awips           [Ensure all processes are running.]

```

13. Check for EDEX and start on DX4 if it is not already running.

Connect to the dx4 via the System Console and log in as root once booted

```

Enter:    ps -fu awips           [Make sure no processes are running.]
Enter:    service edex_camel start
Enter:    service edex_camel status
   [Make sure all processes show
   running.]
Enter:    ps -fu awips           [Ensure all processes are running.]

```

**NCEP Only:** Power up the DX5 and DX6 using the same steps used for the DX4 in Step 13.

14. Check for the a2px1apps package and start on PX1 if it isn't already running.

Connect to the px1 via the System Console and log in as root once booted

**Enter:**        df /data\_store

**Enter:**        hb\_stat

Look for the a2px1apps package running. If it is NOT running, issue the following two commands:

**Enter:**        hb\_run a2px1apps

**Enter:**        hb\_stat                                    [Check for package running.]

15. Check for the a2px2apps package and start on PX2 if it isn't already running.

Connect to the px2 via the System Console and log in as root once booted

**Enter:**        df /data\_store

**Enter:**        hb\_stat

Look for the a2px2apps package running. If it is NOT running, issue the following two commands:

**Enter:**        hb\_run a2px2apps

**Enter:**        hb\_stat                                    [Check for package running.]

### 21.3 *Verification of System Startup While Running AWIPS II Configuration*

**IMPORTANT** → Before continuing, ensure that all servers, workstations, and devices are powered-on and accessible via the network.

1. Verify that all HA packages are up and that a valid **Start Time** is reported via the **hb\_stat** command.

An example of a typical output of the **hb\_stat** command, on DX1 and DX2, follows.

```

Heartbeat Status Monitor                               Oct 27 22:26:31
===== Member Status =====
Member      Status      IP address
-----
dx1-tbdw    Up          165.92.29.131
dx2-tbdw    unknown    165.92.29.132
===== Service Status =====
Service     IPaddr     Cronfile   Owner    Start Time
-----
a2dx1apps   165.92.29.195 a2dx1cron,a2SIT dx1-tbdw 2011-07-11 20:21:50
a2dx2apps   165.92.29.196 a2dx2cron,a2SIT none     down

```

An example of a typical output of the **hb\_stat** command, on DX3 and DX4, follows.

**dx[3|4]-tbdw is not part of an heartbeat cluster**

An example of a typical output of the **hb\_stat** command, on PX1 and PX2, follows.

```

Heartbeat Status Monitor                               Oct 27 22:28:52
===== Member Status =====
Member      Status      IP address
-----
px1-tbdw    Up          165.92.29.137
px2-tbdw    unknown    165.92.29.138
===== Service Status =====
Service     IPaddr     Cronfile   Owner    Start Time
-----
a2px1apps   165.92.29.193 a2px1cron,a2SIT px1-tbdw 2011-10-13 17:40:47
a2px2apps   165.92.29.194 a2px2cron,a2SIT none     down

```

2. Verify that the pertinent mounts are present.

When running in AWIPS II configuration, the AWIPS I NFS and local mounts will still be active on all nodes at all times. In addition to those AWIPS I mounts, the following AWIPS II-specific mounts should be present.

- On **PX2**:
  - /dev/mapper/vg00-lvol\_awips2 → /awips2
  - nas1: /aiidata -> /awips2/edex/data
  - nas1: /GFESuite2 -> /awips2/GFESuite
  - nas2:/data\_store /data\_store

- On **PXI**:
    - /dev/mapper/vg00-lvol\_awips2 → /awips2
    - nas1:/aiidata -> /awips2/edex/data
    - nas1:/GFESuite2 → /awips2/GFESuite
    - nas2:/data\_store /data\_store
  - On **DX1**:
    - /dev/mapper/vg00-lvol\_awips2 → /awips2
    - /dev/mapper/vg\_aiidb-awipsiidx -> /awips2/data
    - nas1:/aiidata/utility -> /awips2/edex/data/utility
    - nas1:/GFESuite2 → /awips2/GFESuite
    - nas2:/data\_store /data\_store
  - On **DX2**:
    - /dev/mapper/vg00-lvol\_awips2 → /awips2
    - /dev/mapper/vg\_aiildm-awipsiidx → /data\_store
    - nas1:/aiidata/utility -> /awips2/edex/data/utility
    - /dev/mapper/vg\_aiahdf5-awipsiidx -> /awips2/edex/data/hdf5
    - nas1:/GFESuite2 → /awips2/GFESuite
  - On **DX3 and DX4**:
    - /dev/mapper/vg00-lvol\_awips2 → /awips2
    - nas1:/aiidata → /awips2/edex/data
    - nas2:/data\_store /data\_store
3. Check for running processes.

- On **DX3 and DX4** issue the following command:

```
TYPE: ps -ef | grep edex | cut -d "-" -f1,2 |
grep -v grep
```

```
awips 12247 1 0 13:40 ? 00:00:00 ksh
/awips2/edex/data/share/hydroapps/precip_proc/bin/start_hpe
awips 27731 1 0 13:18 ? 00:00:00 /bin/bash /awips2/edex/bin/start.sh -noConsole
awips 27792 27731 0 13:18 ? 00:00:12 java -jar /awips2/edex/bin/yajsw/wrapper.jar
awips 27814 27792 53 13:18 ? 01:24:48 /awips2/java/bin/java -Dedex.run.mode=ingest
awips 27882 1 0 13:18 ? 00:00:00 /bin/bash /awips2/edex/bin/start.sh -noConsole
awips 27943 27882 0 13:18 ? 00:00:12 java -jar /awips2/edex/bin/yajsw/wrapper.jar
awips 27978 27943 29 13:18 ? 00:45:57 /awips2/java/bin/java -Dedex.run.mode=ingestGrib
awips 28047 1 0 13:18 ? 00:00:00 /bin/bash /awips2/edex/bin/start.sh -noConsole
awips 28108 28047 0 13:18 ? 00:00:03 java -jar /awips2/edex/bin/yajsw/wrapper.jar
awips 28131 28108 14 13:18 ? 00:22:12 /awips2/java/bin/java -Dedex.run.mode=ingestDat
awips 28203 1 0 13:18 ? 00:00:00 /bin/bash /awips2/edex/bin/start.sh -noConsole
awips 28264 28203 0 13:18 ? 00:00:04 java -jar /awips2/edex/bin/yajsw/wrapper.jar
awips 28290 28264 8 13:18 ? 00:13:07 /awips2/java/bin/java -Dedex.run.mode=request
```

**NOTE:** Three **start.sh** scripts should be running (four if IngestDat is running); they are the parent processes of the three wrappers (the Java wrapper serves as, among other things, a watchdog for the JVM should it crash and need to be restarted). The System V init script **edex\_camel** kicks off one **start.sh**, which launches the wrapper, which in turn launches the three JVMs: 1) ingestGrib; 2) request; and 3) ingest. In total, **NINE (9)** EDEX ESB Java-related processes should be running on DX3 and DX4 respectively. In addition, a single **start\_hpe** process should be running; it controls the related HPE (e.g., DHRgather) processes.

- On **DX1**, issue the following command:

**TYPE:** `ps -fU awips | grep -v idle | cut -d "-" -f1,2`

UID	PID	PPID	C	STIME	TTY	TIME	CMD
awips	15139	1	1	Jul19	?	00:57:02	/awips2/java/bin/java -cp /awips2/rcm/data/config/res:/awips2/rcm/lib/activation
awips	24009	1	0	Jul18	?	00:01:34	/awips2/postgresql/bin/postmaster -D /awips2/data
awips	24018	24009	0	Jul18	?	00:00:39	postgres: logger process
awips	24020	24009	0	Jul18	?	00:00:28	postgres: checkpointer process
awips	24021	24009	0	Jul18	?	00:00:36	postgres: writer process
awips	24022	24009	0	Jul18	?	00:00:14	postgres: wal writer process
awips	24023	24009	0	Jul18	?	00:09:31	postgres: autovacuum launcher process
awips	24024	24009	0	Jul18	?	00:27:02	postgres: stats collector process

**NOTE:** There should be a single postmaster process running which drives the postgreSQL AWIPS II database engine along with 6 subsequent process threads (logger, writer, wal writer, autovacuum, stats collector, checkpointer).

- On **CPSBNI** check for the LDM processes running (`ps -ef | grep ldm`).
  - LDM should have pqact; edexBridge (connected to the server running Qpid); and ldmd.conf
- On **DX2**, there should be no AWIPS II-related process running. DX2 serves as a “hot spare” or “hot-standby” to the DX1 and the a2dx1 apps resource.
- On **PXI**, issue the following command:

**TYPE:** `ps -fU fxa,awips`

UID	PID	PPID	C	STIME	TTY	TIME	CMD
fxa	8968	1	0	Aug15	?	00:00:01	/awips/fxa/bin/asyncPilMsgServer
fxa	8971	1	0	Aug15	?	00:00:07	/awips/fxa/bin/asyncScheduler
fxa	8991	1	0	Aug15	?	00:04:58	/usr/bin/perl /awips/fxa/bin/asyncPollData.pl
fxa	8999	1	0	Aug15	?	00:18:08	/awips/fxa/bin/hmMonitorServer
fxa	9031	1	0	Aug15	?	00:00:05	/awips/fxa/bin/NWWSSchedule
fxa	9320	8971	0	Aug15	?	01:13:46	test1 20 19 1 test1 /dev/tty1a 9600 8 NONE 1 NONE
fxa	9321	8971	0	Aug15	?	02:31:15	test2 22 20 2 test2 /dev/tty1b 9600 8 NONE 1 NONE
fxa	9989	1	0	Aug15	?	02:04:37	/awips/fxa/bin/purgeProcess -commit
awips	17277	9191	0	03:38	?	00:00:00	/usr/sbin/httpd
awips	17278	9191	0	03:38	?	00:00:00	/usr/sbin/httpd
awips	17279	9191	0	03:38	?	00:00:00	/usr/sbin/httpd
awips	17280	9191	0	03:38	?	00:00:00	/usr/sbin/httpd
awips	17281	9191	0	03:38	?	00:00:00	/usr/sbin/httpd
awips	17282	9191	0	03:38	?	00:00:00	/usr/sbin/httpd
awips	17283	9191	0	03:38	?	00:00:00	/usr/sbin/httpd
awips	17284	9191	0	03:38	?	00:00:00	/usr/sbin/httpd
awips	17285	9191	0	03:38	?	00:00:00	/usr/sbin/httpd

**NOTE:** EIGHT (8) **httpd** threads should be running; they control the AWIPS II System Monitor. Two **getty** serial ports (named **/dev/tty1q[a,b]**) should be initialized; they are used by the **asyncScheduler**, which should also be running with the two **async** processes, **asyncPilMsgServer** and **asyncPollData.pl**. The AWIPS II **hmMonitorServer** and **NWWSSchedule** should be running. The GUI controller for IPVS (named **piranha.gui**) should be listed as well as the IPVS process **nanny**, connected on port 9581 to the IPADDR of the DX3 and DX4.

4. On **PX2**, issue the following commands:

```
TYPE: ps -fU ldad,fxa,ldm | cut -d "-" -f1,2; ps
        -ef | egrep 'iscsi|nfs' | \
        grep -v grep
```

**NCEP Only:** Note that some of the baseline fxalpha rehosted code is not operational at NCEP Centers; therefore, output might be different. Contact the NCF if you believe that system startup on the PX\_SERVERS was not completed properly.

**NOTE:** The above command is all on one line. The “\” character at the end is an indication to the reader of such, and should not be included in the command issuance.

A table of running processes on PX2 follows.

UID	PID	PPID	C	STIME	TTY	TIME	CMD
fxa	2046	1	0	Oct13	?	00:00:00	/awips/fxa/bin/ldadServer
fxa	2081	1	0	Oct13	?	00:00:00	/bin/sh /awips/fxa/FSIedex/bin/fsiWatchdog.sh
fxa	2083	2081	0	Oct13	?	00:07:44	/awips/fxa/FSIedex/bin/FSIprocessorEDEX
fxa	2085	1	0	Oct13	?	00:00:00	/awips/fxa/fsi/bin/rssd
ldad	2603	1	0	Oct13	?	00:00:00	/awips/ldad/bin/listener
ldad	3016	1	0	Oct13	?	00:00:05	/awips/fxa/bin/CommsRouter LDAD_ROUTER
ldad	3024	1	0	Oct13	?	00:00:04	/awips/fxa/bin/DataController LDAD_ROUTER LdadController.config
ldad	3027	3024	0	Oct13	?	00:00:15	/awips/fxa/bin/routerLdadDecoder px2- tbdw/44356/3024 152708368
ldad	3028	3024	0	Oct13	?	00:01:41	/awips/fxa/bin/routerStoreNetcdf px2- tbdw/44356/3024 152735008
ldad	3029	3024	0	Oct13	?	00:00:16	/awips/fxa/bin/routerStoreEDEX px2- tbdw/44356/3024 152743928
ldad	3030	3024	0	Oct13	?	00:00:18	/awips/fxa/bin/routerShelfEncoderEDEX px2- tbdw/44356/3024 152744152
ldad	3031	3024	0	Oct13	?	00:00:16	/awips/fxa/bin/routerStoreTextEDEX px2- tbdw/44356/3024 152744456
ldad	3048	1	0	Oct13	?	00:00:29	/bin/sh /awips/ldad/bin/watchDogInternal.sh
fxa	9624	1	0	Sep08	?	01:03:58	/awips/fxa/bin/purgeProcess -commit
ldad	18092	3048	0	23:43	?	00:00:00	sleep 30
ldad	24387	3048	0	00:00	?	00:00:02	/usr/bin/perl /awips/ldad/bin/pollForData.pl Start /awips/ldad/data/pollForData.conf

**NOTE:** The AWIPS II LDAD and FSI processes should be running and match those in the output above (with the exception of the node domain name which will match your siteID).

## 21.4 AWIPS II Checklist

Start the browser on the workstation and check the System Monitor.

### DX1

- Is postgres running (ps -ef | grep postgres)? Logging (/awips2/data/pg\_log)?
- Is RadarServer running (ps -ef | grep Radar)? Logging (/awips2/rcm/data/logs)?



- Any partitions full (df)? Everything mounted (/awips2, /data\_store, /awips2/data, /awips2/GFESuite, nas1:/awips2/edex/data/utility)?
- Heartbeat running, a2dx1apps running, dx1f up (ping dx1f)?
- MHS (ps -ef | grep mhs; ypcat hosts | grep mhs)? Sendmail? (ps -ef | grep sendmail; msg\_send -atbdr -c0;)

**DX2**

- Heartbeat running, a2dx2apps running, dx2f up (ping dx2f)?
- Any partitions full (df)? Everything mounted (/awips2, /data\_store, /awips2/GFESuite, nas1:/awips2/edex/data/utility, /awips2/edex/data/hdf5)?

**DX3/4**

- Is edex ingest, ingestGrib, ingestDat and request running (ps -ef | grep edex)?
- Are they logging ingesting data (/awips2/edex/logs, edex-ingest, edex-ingestGrib, ingestDat, request, ingest-satellite, ingest-radar, ingest-shef, ingest-text, ingest-purge, ingest-gen\_areal\_ffg)?
- Any partitions full (df)? Everything mounted (/awips2, /data\_store, /awips2/edex/data, /awips2/GFESuite)?
- Clustering loopback device up (ifconfig lo:0)?
- (Also check PX3|4)

**NCEP Only:** Also check DX5 and DX6.

**CPSBN1**

- Is ldm running (ps -ef | grep ldm, ps -wef|grep dvbs)?
- Is data being received (su - ldm -c 'ldmadmin watch', check logs in ~ldm/logs)?
- Is qpid running (ps -ef | grep qpid)?
- IPVS running (ps -ef|grep pulse, ipvsadm)?
- Heartbeat running, a2cp1apps running, cp1f up (ping cp1f, hb\_stat)?
- Any partitions full (df)? Everything mounted (/awips2, nas1:/awips2/qpid/messageStore)?

**PX1**

- Any partitions full (df)? Everything mounted (/awips2, /awips2/edex/data/share, /data\_store)?
- Heartbeat running, a2px1apps running, px1f up (ping px1f)?

- Rehosted apps running (ps -ef | grep fxa)?

### PX2

- Any partitions full (df)? Everything mounted (/awips2, dx2f:/data\_store, /awips2/edex/data/share)?
- Heartbeat running, a2px2apps running, px2f up (ping px2f)?
- Rehosted apps running (ps -ef | grep ldad; ps -ef|grep fsi)?

### Workstations

- DNS, NIS, NTP working? Any partitions full (df)? Everything mounted (/awips2/edex/data/share, /data\_store, /awips2)?
- Launch CAVE. Does it come up okay? Data current in the menus and selected products load? (Load Radar (i.e., koax) > Composite Ref; Satellite > IR Window; Obs > Station Plot (load the latest under METAR); Maps > Hires TOPO Image (checkbox); Load GFE, make sure gfeConfig is selected in Config column, click OK.)

## 21.5 LDM Ingest Checklist

In order to add a line to the pqact.conf or pqact.local file for LDM ingest, certain information is necessary. The following is a general checklist of information that can be used when adding new data from the SBN into the system.

- Note the WMO header or pattern for desired product: \_\_\_\_\_
- Note the LDM FEEDTYPE for the desired product: \_\_\_\_\_
- Note the raw archive location for the desired product: \_\_\_\_\_
- Create entry in the pqact.conf or pqact.local file: \_\_\_\_\_
- Restart or send HUP to ldmd process on cpsbn.

The following steps may be useful in finding the above information.

1. Find the WMO header or pattern for the desired product.

If the product is being ingested into an AWIPS I system, look at the /data/fxa/customFiles/acqPatternAddOns.txt file. It is possible that you will discover the WMO pattern needed for ingesting. A listing of WMO header bulletins can also be found starting at the following URL: <http://www.nws.noaa.gov/tg/table.html>.

2. Find the LDM FEEDTYPE for the desired product.

In all cases, the FEEDTYPE “ALL” will match all the FEEDTYPES listed. However, tools are available that may help identify the proper FEEDTYPE, if that is of interest. As user *ldm* the following commands might be useful:

**# ldmadmin watch**

This command will show all data coming from the upstream LDM server. This should be every product that the upstream is ingesting. Watching can identify specific feedtypes of the products being ingested. A sample output of the command follows.

```
-bash-3.2$ ldmadmin watch
(Type ^D when finished)
Feb 15 00:57:22 pqutil INFO:      11428 20130215005721.933 NEXRAD3 294145880
SDUS23 KDDC 150054 /pN2QDDC !nids/
Feb 15 00:57:22 pqutil INFO:       8218 20130215005721.933 NEXRAD3 294145881
SDUS23 KGID 150050 /pN2QUEX !nids/
Feb 15 00:57:22 pqutil INFO:      12879 20130215005721.933 NEXRAD3 294145882
SDUS23 KGID 150050 /pN2UUEX !nids/
Feb 15 00:57:22 pqutil INFO:      29132 20130215005721.933 NEXRAD3 294145883
SDUS54 KOUN 150056 /pDHROKC !nids/
Feb 15 00:57:22 pqutil INFO:      40926 20130215005721.933 NEXRAD3 294145884
SDUS54 KBMX 150054 /pN0UBMX !nids/
Feb 15 00:58:35 pqutil INFO:       6937 20130215005835.178 IDS|DDPLUS
294147491 SRUS22 KWOH 150057 /pRRSTIR
Feb 15 00:58:35 pqutil INFO:        218 20130215005835.178 IDS|DDPLUS
294147492 SRUS57 KWOH 150057 /pRRSOHX
Feb 15 00:58:35 pqutil INFO:       2210 20130215005835.178 IDS|DDPLUS
294147493 SAXX60 KWBC 150100 RRB
Feb 15 00:58:35 pqutil INFO:        132 20130215005835.178 IDS|DDPLUS
294147494 SXTN50 KWAL 150057
Feb 15 00:58:35 pqutil INFO:        103 20130215005835.178 IDS|DDPLUS
294147495 SXMS50 KWAL 150057
```

**# notifyme -l- -h \$LDM\_HOST -v -p '<WMO ID Pattern>'**

This command will print to the screen every product available from <LDM Upstream IP/Hostname> that matches <WMO ID Pattern>. For example, the following would print all products starting T available from CPSBN2:

```
notifyme -l- -h cpsbn2 -v -p '^T.*'
```

**Note:** The pattern passed to notifyme, and put into the pqact.conf file, must be a valid regular expression.

A sample output of the command follows.

```
-bash-3.2$ notifyme -l- -v -h adam1 -p '^sat.*TI.*'
Jan 21 15:17:37 notifyme[6887] NOTE: Starting Up: adam1: 20110121151737.886
TS_ENDT {{ANY, "^sat.*TI.*"}}
Jan 21 15:17:37 notifyme[6887] NOTE: LDM-5 desired product-class:
20110121151737.886 TS_ENDT {{ANY, "^sat.*TI.*"}}
Jan 21 15:17:37 notifyme[6887] INFO: Resolving adam1 to 165.92.24.36 took
0.000398 seconds
Jan 21 15:17:37 notifyme[6887] NOTE: NOTIFYME(adam1): OK
Jan 21 15:19:33 notifyme[6887] INFO:      26096 20110121151933.179 NIMAGE
47222 satz/ch1/GOES-13/SOUND-14.06/20110121 1446/EAST-CONUS/10km/ TIGE43
KNES 211446
```

```
Jan 21 15:19:34 notifyme[6887] INFO:      72646 20110121151934.390 NIMAGE
47223  satz/ch1/GOES-13/SOUND-11.03/20110121 1446/EAST-CONUS/10km/ TIGE48
KNES 211446
Jan 21 15:19:38 notifyme[6887] INFO:      58914 20110121151938.479 NIMAGE
47224  satz/ch1/GOES-13/SOUND-7.43/20110121 1446/EAST-CONUS/10km/ TIGE50
KNES 211446
Jan 21 15:19:40 notifyme[6887] INFO:      51259 20110121151940.513 NIMAGE
47225  satz/ch1/GOES-13/SOUND-7.02/20110121 1446/EAST-CONUS/10km/ TIGE51
KNES 211446
Jan 21 15:19:44 notifyme[6887] INFO:      45947 20110121151944.599 NIMAGE
47226  satz/ch1/GOES-13/SOUND-6.51/20110121 1446/EAST-CONUS/10km/ TIGE52
KNES 211446
```

Both of these commands will give other information that can be used in writing the data to disk in the raw archive in a more useful format.

3. Note the raw archive location for the product.

In general, the raw archive used is `/data_store/<product type>`. For example, radar products are put into a subtree of `/data_store/radar` based on the information. It is good practice to continue to follow this paradigm. However, as long as the `-edex` argument is used in the `pqact.conf` entry, the product should be decoded no matter where the physical storage location ends up as long as the EDEX server has access to that location.

4. Create the `pqact.conf` entry.
5. Restart or send HUP signal to LDM server.

Restart or send an HUP signal to the LDM server.

## **Chapter 22**

# **Maintenance Management Procedures**

## Chapter 22. Maintenance Management Procedures

### Table of Contents

		<i>Page</i>
22.1	General System Administration Activities .....	1
22.1.1	Oversight and Administration of Site OT&E Activities .....	1
22.1.2	Coordination with NCF and AWIPS Contractor.....	1
22.1.3	Performance and Administration of System Software Upgrades .....	2
22.1.4	Performance and Administration of System Hardware Upgrades and Modifications.....	3
22.1.5	Coordination with Regional and National NWS AWIPS Staffs .....	3
22.1.6	Site Hardware Configurations .....	3
22.1.7	System Software Configurations .....	3
22.1.8	Site Applications and Extension Software Configurations .....	3
22.1.9	Site AWIPS System Security .....	4
22.1.10	Site Documentation Data.....	4
22.1.11	Global and Local AWIPS System Software Backups .....	4
22.1.12	Daily Monitoring and Administration of Operational System .....	4
22.1.13	EMRS Maintenance Data Reporting and Monitoring .....	4
22.2	System Maintenance Activities.....	5
22.2.1	Daily Actions.....	5
22.2.2	Weekly Actions .....	6
22.3	Maintenance Troubleshooting Checklist .....	6
22.3.1	Routine Maintenance Checklist.....	6
22.3.2	Unscheduled Maintenance Checklist .....	7
22.4	AWIPS Maintenance and System Administration Reporting.....	7
22.4.1	Modification/Software/Maintenance Note and Request for Change (RC) Implementation.....	8
22.5	Demarcation of AWIPS Hardware Maintenance Responsibility.....	9

### List of Tables

Table 22.4-1.	AWIPS Equipment Codes .....	7
Table 22.4.1-1.	Reporting Guidelines for Modifications.....	9

## **22.0 Introduction**

Because of the complexity of the AWIPS hardware, software, and other integrated devices, it is necessary to perform an extensive suite of maintenance activities on a regularly scheduled basis. Significant daily system monitoring and maintenance tasks are required to maintain a high level of successful operational capability.

The guidelines and tasks in this chapter are recommendations and form a base for the site-specific system(s) maintenance program. Maintenance shall be performed following NWSI 30-2113 AWIPS maintenance policy. For this chapter only, “ESA” is defined to mean Electronic Systems Analyst (ESA), Information Technology Officer (ITO), or electronic maintenance staff, as assigned.

### **22.1 General System Administration Activities**

This section describes an overall system administrative and equipment maintenance plan and addresses specific activities for AWIPS II operational systems. It is intended as a reference for ESAs in maintaining their AWIPS sites. It is not all inclusive, and it is not directive in nature.

#### **22.1.1 Oversight and Administration of Site OT&E Activities**

Major functional releases undergo an Operational Test and Evaluation (OT&E) phase, and the ESA will play a large part in these activities. The test and evaluation phase is critical for generating feedback about the system to AWIPS developers and National Weather Service Headquarters (WSH) managers.

During OT&E, many facets of the site’s AWIPS operations and administration are evaluated by local staff and managers, and by assigned NWS personnel at WSH. For example, products, display capabilities, enhancements, communications, data feed from radar and the Satellite Broadcast Network (SBN), grids, data reception, data storage and retrieval, and many other areas of the overall system operation are scrutinized.

The ESA participates in the logging of OT&E data collection, ensuring that the evaluation data are forwarded to the NWS in a timely manner. Further, the ESA coordinates all software and hardware trouble reports with the Network Control Facility and administers all software and hardware modifications to the system.

#### **22.1.2 Coordination with NCF and AWIPS Contractor**

Coordination with the NCF is necessary to ensure monitoring of all site system hardware and software, and the efficient repair of any anomalies or failures.

The NCF's telephone number, 301.713.9344, is intended for use by any operations or administrative staff member. The number should be prominently posted in all WFO/RFC operations areas.

The ESA performs preliminary examination of system failures and discusses findings with NCF staff. If necessary, the ESA should be able to engage in dialog with software developers (Raytheon, Systems Engineering Center [SEC], Global Systems Division [GSD]) and to discuss hardware issues with designers, engineers, and technicians associated with the Raytheon, Verizon (FTS2001), NOAA Net, Globecom, and the NCF.

When on-site repairs are necessary, the ESA should monitor the work of assigned contractor personnel and assist those technical contractors, when needed.

All maintenance actions, software, and hardware are documented in appropriate reports with the NCF and in the NWS Engineering Management Reporting System (EMRS).

### ***22.1.3 Performance and Administration of System Software Upgrades***

During the life cycle of the system, the ESA should be able and available to perform the many software installations and upgrades that will be necessary to ensure that the system is always configured according to all established configuration management guidelines. The ESA will be the site focal point for all system upgrades and will ensure that these upgrades are accomplished in accordance with authorized system upgrade instruction notes. The ESA will also ensure that all system upgrades at his or her site are documented in EMRS.

Software upgrades can take any of the following forms:

- **Application Releases.** The AWIPS Contractor distributes application releases to the sites by CD-ROM or DVD, depending on the size of the release. The ESA loads the software from the CD-ROM or DVD following the install instructions; the install may be monitored remotely by the AWIPS Contractor personnel.
- **Maintenance Releases and Emergency Releases.** Depending on the size of the release, maintenance upgrades and emergency releases may be distributed to the sites on CD-ROM or DVD, or downloaded to the sites over the WAN. The ESA accomplishes the upgrade using scripts and install instructions provided by the software developers. The installation may be monitored remotely by AWIPS Contractor personnel.
- **Patches.** Often, small short-term patches in system software are accomplished by developers, and an isolated program file is downloaded to the appropriate site system by the NCF, the AWIPS Contractor, or NWS developers. In all cases, the ESA will be notified of the changes being made.



#### ***22.1.4 Performance and Administration of System Hardware Upgrades and Modifications***

Occasionally, AWIPS hardware configuration items must be upgraded or replaced with a newer device. As the site focal point for all such modifications, the ESA will interface directly with Contractor personnel to coordinate the time for the upgrade, and work with the actual hardware upgrade or replacement. The ESA will ensure that these upgrades are accomplished at the site in accordance with authorized instruction notes; the ESA will also ensure that all upgrades are documented in EMRS.

#### ***22.1.5 Coordination with Regional and National NWS AWIPS Staffs***

The ESA should maintain a regular dialog with regional AWIPS staff members to ensure that all regional directives and guidelines are applied to the operation and maintenance of his or her system.

#### ***22.1.6 Site Hardware Configurations***

In coordination with regional and national AWIPS staff, the ESA maintains records of all installed equipment. The ESA also ensures that all modifications and repairs are accomplished properly and that no unauthorized system configuration changes or additions are installed without approval from NWS Headquarters.

Many hardware records, materials reports, and documentation are delivered with the system. Some of these will be updated with each software or hardware modification. The ESA maintains all system hardware records.

#### ***22.1.7 System Software Configurations***

In coordination with regional and national AWIPS staff, the ESA maintains records of all installed software systems. The ESA ensures that all system upgrades, modifications, and local applications are accomplished properly and that no unauthorized system configuration changes or additions are installed without approval from NWS Headquarters.

Each national software build and incremental upgrade will require updates to local site configuration files, map databases, and other records.

#### ***22.1.8 Site Applications and Extension Software Configurations***

Ultimately, local sites will adapt their older PC-based software to AWIPS platforms and will generate new programs for local use on AWIPS. The ESA will maintain a record of all local applications suites and extensions and ensure that all site software operates properly in the AWIPS environment.

ESAs must be constantly aware of all local applications installed on their local systems and ensure that they do not adversely affect any approved and established system and applications software.

### ***22.1.9 Site AWIPS System Security***

In coordination with regional and national AWIPS staff, the ESA must be fully involved in all system security efforts. These responsibilities include the management of national security systems, as well as local site security issues.

The NWS operates a national firewall system in the National Weather Service Modernization and Test Integration System (NMT) in Silver Spring, Maryland. This firewall isolates all AWIPS intranet sites from unauthorized external influences. It is the site ESA's responsibility to ensure that all access through the national firewall is registered. Refer to Appendix F, NWS/AWIPS Security Policy, for information on registering for firewall access.

Local firewalls will be developed and deployed as necessary to accommodate acquisition of other data (e.g., LDAD firewall).

### ***22.1.10 Site Documentation Data***

All site documentation should be maintained by the ESA. This includes operations manuals, system support documentation, installation records, maintenance records, system administration logs, and backup documentation and media.

### ***22.1.11 Global and Local AWIPS System Software Backups***

The ESA should ensure that all system backup procedures are properly established and correctly accomplished on a suitable schedule. These backups include system software and configuration data, database transaction records, local applications, and configuration software and data, as applicable.

### ***22.1.12 Daily Monitoring and Administration of Operational System***

The ESA must participate in the daily operational monitoring and administration of the local AWIPS. He or she will coordinate closely with the site operational personnel to ensure that all system functions are working correctly and take immediate action whenever anomalies are noted. Refer to checklist in Appendix I, Section I.11

### ***22.1.13 EMRS Maintenance Data Reporting and Monitoring***

The ESA will measure how effectively his or her site has satisfied EMRS reporting requirements by reviewing AWIPS maintenance activity, system upgrade, and

modification reports via the EMRS web page [http://ops13web.nws.noaa.gov/pls/emrsuser/emrs\\_main.home](http://ops13web.nws.noaa.gov/pls/emrsuser/emrs_main.home). The ESA will take action to comply fully with guidelines identified in NWS Instruction 30-2104, Maintenance Data Documentation, available at <http://www.nws.noaa.gov/directives/>.

## 22.2 *System Maintenance Activities*

This section describes the type and frequency of AWIPS hardware maintenance actions recommended for NWS field ESAs and maintenance staff.

### 22.2.1 *Daily Actions*

ESAs should complete the following actions on a daily basis.

- **Coordinate with operational personnel.** The ESA should check with the operational staff members each morning to discuss the general operation of the system and any problems or anomalies that users may have noted. Ensure that all unusual situations described are entered in the daily site logs.
- **Ensure that daily logs are completed.** All assigned daily AWIPS log sheets should be reviewed and properly completed. All warranted action items noted should be resolved as quickly as possible.
- **Determine requirements for additional local backups.** As AWIPS users become familiar with the system, they will create local scripts and executable programs to be used for various purposes. These programs and data sets must be backed up at the site.
- **Check the Satellite Ground Station.** Visually inspect the ground station antenna for obstructions and proper heater operation. Clean as necessary.
- **Perform a general system check.** Open a terminal window and log in to each server and workstation. Verify that each device responds properly. Check for and remove core dumps. Check disk statistics and processes on each device, ensuring that all necessary programs are operating and that no runaway processes are present. Kill runaway processes as necessary. Check LAN and WAN connectivity by pinging another local device and then pinging a remote system, such as one of the NCF servers or an adjacent WFO device.
- **Launch the system data monitor, and verify that all data are current.** Investigate any evidence of late or missing data.
- **Review log files.** As necessary, review appropriate system log files, looking for error messages and other indications of communications, data retrieval, data routing, data storage, and data display anomalies and failures. Make appropriate notes in the site logs and take action to correct any noted deficiencies.
- **Verify D2D functionality.** In coordination with the users, operate D2D at each workstation, verifying proper menu availability and product display capability.

- **Visually check each workstation area for neatness and cleanliness.** Clean all monitor screens with appropriate glass cleaner and a soft, lint-free cloth. Check for other contaminants, such as spills in keyboards, and clean as necessary.
- **Verify printer functionality.** Check each system printer for proper operation. Verify that all copies are complete and colors are correct.

### 22.2.2 Weekly Actions

ESAs should complete the following actions on a weekly basis.

- **Back up applications and data sets.** Perform backups of all locally developed applications and data sets, as necessary.
- **Check power cables and connections.** Check the areas around each workstation, ensuring that all cables are properly distributed between the monitors and the workstation base unit and that connections are secure. Check cables, as well as all power cables and connections.
- **Clean work surfaces and base units.** With a soft, damp cloth, clean areas around monitors and workstation surface areas, removing any dust and other debris. Ensure that all dust and other debris are cleaned from all surfaces of workstation base unit, especially around cooling fans.
- **Check printer connections.** Check the areas around each system printer to ensure that all cables are properly distributed between the printer and servers and that connections are secure. Check all power cables and connections.
- **Clean printer surfaces.** With a soft, damp cloth, clean areas around printers and associated work surface areas, removing any dust and other debris. Open the printers and remove dust and other debris.

### 22.3 Maintenance Troubleshooting Checklist

This section includes two quick checklists – one for routine maintenance and one for unscheduled maintenance. The Routine Maintenance checklist includes items that should be checked daily. The Unscheduled Maintenance checklist includes items to be checked as needed.

#### 22.3.1 Routine Maintenance Checklist

- \_\_\_\_\_ Printer queue
- \_\_\_\_\_ All devices. Partition sizes (using `and` `df` command for Linux servers)
- \_\_\_\_\_ Cron system monitoring

### 22.3.2 *Unscheduled Maintenance Checklist*

- \_\_\_\_\_ Hardware monitor
- \_\_\_\_\_ Printer maintenance
- \_\_\_\_\_ NCF interaction

### 22.4 *AWIPS Maintenance and System Administration Reporting*

AWIPS maintenance and system administration activities are documented in EMRS NWS Instruction 30-2104, Maintenance Data Documentation, issued under NWS Policy Directive 30-21, *Systems Maintenance*. Appendix F of this *System Manager's Manual* describes policy and procedures necessary for documenting AWIPS maintenance and system administration.

As discussed in EMRS NWS Instruction 30-2104, in most cases one WS Form A-26 (<http://www.weather.gov/wsom/manual/archives/NA149505.HTML#APPENDIX%20A>) is initiated for each maintenance action performed. A single WS Form A-26 may be initiated on a biweekly basis to report all system administration duties. Initiate a WS Form A-26 for all designated AWIPS equipment, systems, or subsystems when the Field Electronics Staff:

- Resolves equipment failures
- Performs routine maintenance
- Relocates equipment
- Conducts special activities or data collection
- Activates deactivates, or modifies equipment
- Accomplishes system administration.

Contact the WSH Maintenance, Logistics, and Acquisition Division, Configuration Branch (W/OPS13), at 301.713.1892, for information or assistance regarding WS Form A-26.

Four equipment codes have been defined for use when documenting AWIPS maintenance activity in EMRS. The AWIPS equipment codes are listed in Table 22.4 -1.

**Table 22.4-1. AWIPS Equipment Codes**

Equipment Type	Equipment Code
AWIPS Local Data Acquisition and Dissemination Server	LDAD
AWIPS Remote Display	ARD
AWIPS Linux Servers and Workstations	AWLNX
AWIPS System Administration Reporting Code	AWIPS

**NOTE:** Use EMRS Equipment Code “FAC” to report incidental facilities maintenance/activities performed at the AWIPS site.

AWIPS equipment codes are activated in EMRS by the Field Staff. Submit one WS Form A-26 to report all activities associated with site preparation, installation, and checkout of the equipment, system, or subsystem. Field Staff may be responsible for activating particular AWIPS equipment as directed in an official Modification Note, Maintenance Note, Software Note, or Request for Change Implementation Memorandum. Follow the equipment-specific instructions included in the equipment change documentation to activate AWIPS equipment in EMRS. Prior to official activation, the NWS Electronics Staff will report all pre-acceptance activities using the reportable equipment code “AWIPS” and the serial number “001.”

AWIPS system administration is defined as all activities related to managing software operating systems and overseeing systems performance. This includes managing user access and privileges, configuring devices, making backups, training users, managing system security, installing approved operating system software changes and resolving fault isolation issues (e.g., software versus hardware failures).

Configuration Management (CM) information related to scheduled routine maintenance, corrective maintenance, and equipment management activities is documented by the AWIPS maintenance contractor. However, CM information related to activities performed by the NWS Field Staff is documented in EMRS using WS Form A-26. When AWIPS equipment fails, the NCF must be notified. The NCF may determine that the unit will be repaired by the maintenance contractor, returned to the National Reconditioning Center (NRC), or repaired by the Field Staff. When the removal and replacement of the failed unit is performed by the Field Staff, specific CM data reporting is required. These requirements are:

- For each part that fails, enter the correct Agency Stock Number and Serial Number of the failed part.
- For each replacement part, enter the correct Vendor Part Number and Serial Number of the replacement part.

**NOTE:** When replacing an entire subsystem or a part of the subsystem having a uniquely identified serial number, complete two separate WS Forms A-26. The first WS Form A-26 (Deactivation A-26) contains the serial number of the subsystem being removed. The second WS Form A-26 (Activation A-26) contains the serial number of the newly installed subsystem.

#### ***22.4.1 Modification/Software/Maintenance Note and Request for Change (RC) Implementation***

In addition to the data reporting requirements outlined above, follow specific CM data reporting requirements outlined in each official instruction note. Ensure that the

modification number has been entered in the WS Form A-26 and that the date-of-action is completed. General reporting requirements are defined in Table 22.4.1-1.

**Table 22.4.1-1. Reporting Guidelines for Modifications**

Modification Type	TM Code	AT Code	Mod. No.
Hardware Mod	M (Modification)	M (Modify)	The Mod #
Software Mod	M	M	S and the #
Software Patch Mod	M	M	SP and the #
Contractor Interface Note	M	M	CI and the #
System Administration Note	M	M	SA and the #
Information Note	E	M	I and the #
AWIPS System Security Note	M	M	SS and the #
Maintenance Note	E (Equip. Mgmt.)	M	M and the #
RC Implementation	E	M	The RC #
Other Mods	S (Special Acct.)	M	None
Application Software Installation	M	M	None

## 22.5 Demarcation of AWIPS Hardware Maintenance Responsibility

The AWIPS Contractor is responsible for providing AWIPS hardware maintenance. However, several Government hardware and communications interfaces to AWIPS require maintenance outside the scope of Contractor-provided maintenance. The ESA has the systems maintenance responsibilities for equipment such as the WSR-88D radar and various non-AWIPS workstations (i.e., other than those delivered with AWIPS). Routine and nonroutine hardware and software maintenance is performed by ESAs. Additionally, the NWS electronics staff is typically responsible for performing all system administration.

AWIPS maintenance providers are:

### **Raytheon**

- Hardware maintenance and logistics support
- AWIPS Network Control Facility

### **Globecomm Systems, Inc. (also known as GSI)**

- Services for the AWIPS SBN

### **Verizon (FTS2001) and NOAANet (Sprint) (Government-furnished equipment and services)**

- Telecommunications services (FTS2001)

### **NLSC (Government Maintenance)**

When equipment fails, the NCF will attempt to diagnose the cause of the problem. After determining whether the failure is software or hardware related, the NCF will take the appropriate action. During certain types of failures, the NCF may request assistance from the local electronics maintenance staff. Depending on the nature of the failure and the impact on the site's operations, local electronics maintenance staff may work with the NCF or its maintenance subcontractor to repair and restore AWIPS functionality. Any Government-provided external interface to AWIPS is the responsibility of the NWS.

In accordance with NWS directives, any maintenance or system administration performed by NWS Field Staff in support of these activities, regardless of the problem source (hardware or software), shall be reported via EMRS. System administrative work shall be reported biweekly.

Examples of these tasks follow.

- Install system software upgrades.
- Ensure that all AWIPS functions operate normally after upgrades.
- Maintain knowledge of locally developed software.
- Ensure that the security policy is adhered to for local computer networks and interfaces.
- Administer locally assigned passwords.
- Perform backup/recovery for file systems.
- Perform manual system shutdown/startup.
- Manage system log files.
- Manage product retention/replenish parameters.
- Coordinate and oversee the maintenance contractor's work.
- Advise NCF of progress or resolution of maintenance-related problems.

Site hardware maintenance tasks to be performed by the ESA follow.

- Manage AWIPS image tapes (create, store, insert, and remove tapes).
- Perform a hard reset of devices.
- Assist the NCF when troubleshooting possible cable or external interface problems.
- Visually verify device status lights or configurations when requested by the NCF.

Refer to EHB-13, Series II, for additional maintenance guidance.

Site administrators who experience problems or have concerns regarding the NCF or its maintenance providers should contact the Government point of contact for NCF operations:



Kevin Conaty  
Voice 301.713.0864 x170  
Fax 301.713.1409  
Kevin.Conaty@noaa.gov

**Chapter 23**  
**NCF Archive**

## Chapter 23. NCF Archive

### Table of Contents

	<i>Page</i>
23.1 Preparing to Launch the NCF Archive GUI .....	1
23.2 Executing and Using the NCF Archive GUI .....	1
23.3 Displaying Retrieved Archive Products.....	7
23.4 Changing NCF Archive Configuration at a Site .....	8

### List of Exhibits

Exhibit 23.2-1. NCF Archive Window .....	2
Exhibit 23.2-2. Archive Request Window .....	2
Exhibit 23.2-3. Archive Help Screen for Archive Request Window.....	4
Exhibit 23.2-4. Archive Response Browser Window (All Requests Completed) .....	5
Exhibit 23.2-5. Archive Response Browser Window (with Both Completed and Outstanding Requests).....	5
Exhibit 23.2-6. Request Window.....	6
Exhibit 23.2-7. NCF Archive Actions Window.....	7
Exhibit 23.4-1. Archive Config Window in NCF Archive.....	9

The Network Control Facility Product Archive provides the capability to automatically store Guidance Products, Radar Data, Observations, and Official User Products for the most recent 15 days. Data/products are archived by WMO header and date/time group (DTG). Each AWIPS site can query the NCF Archive contents via an interactive GUI and retrieve these data/products for local site storage. Archive request parameters are currently sent from the site to the NCF via an SMTP message. At the NCF, the requested products are retrieved from the archive and transmitted to the requesting site via an SMTP message. The requesting site stores these products to files and updates the **Archive Response Browser** window to show receipt. At this time, only text products can be displayed. Text products can be viewed in a Telnet window using as described in Section 23.3.

### 23.1 *Preparing to Launch the NCF Archive GUI*

Change to a directory appropriate for temporary storage; create a new archive files subdirectory if one does not already exist. It is strongly recommended this subdirectory be created in the **/tmp** directory.

**TYPE:**        `cd /tmp`

**TYPE:**        `mkdir archtest`

**TYPE:**        `cd archtest`

**NOTE:** The **NCF Archive GUI** should be launched from this temporary directory. Any archived data/products received from the NCF will be stored in this directory. Files stored in non-temporary files will not be purged and may cause your file system to fill up. Files stored in **/tmp** are purged upon device reboot; however, it is recommended that you manually remove any files that you are not using from the **/tmp/archtest** directory.

### 23.2 *Executing and Using the NCF Archive GUI*

- ▶ To Execute the NCF Archive GUI on a workstation

**TYPE:**        `/awips/ops/bin/arch_gui &`

The NCF Archive GUI can be launched on any server or workstation; however, there will be less load on the system when the primary data server is used.

To execute the NCF Archive GUI remotely

**TYPE:**        `ssh dx1f"/awips/ops/bin/arch_gui"`

Exhibit 23.2-1 displays the NCF Archive Window.

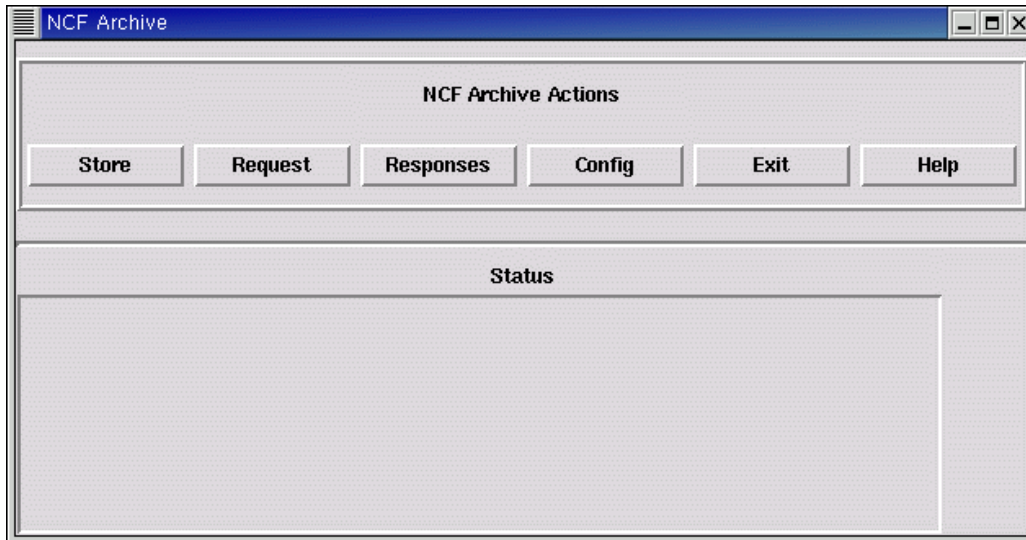

Exhibit 23.2-1. NCF Archive Window

**NOTES:**

- The **Store** button on the NCF Archive menu has not been implemented and an information menu box will pop up with this information if that button is selected.
  - The scan interval, max products, and max list can be changed using the **Config** button on the **NCF Archive** window. However, there is a 20-product maximum and a 200-list maximum. There is no predefined maximum on the scan interval; however, the users probably will not want to increase the default. Refer to section 23.4 for more information. Once the main menu is up, you can proceed to enter your request.
- To Request Archived Data/Products

- Select:**        **Request** from the **NCF Archive Actions** section of the **NCF Archive** window
- Displays the **Archive Request** window. See Exhibit 23.2-2.

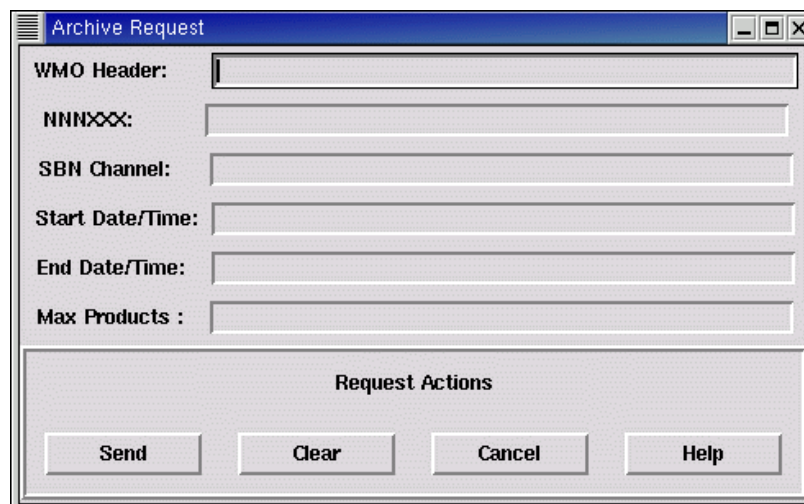

Exhibit 23.2-2. Archive Request Window

- Fill in request parameters as follows (every field is optional):
  - **WMO Header.** This is the standard WMO header format “TTAAii CCCC <DTG>”; e.g., SAUS97 KMGM 120100. Wildcards may be used (see Note below).
  - **NNNXXX.** The standard AFOS-based NNNXXX (e.g., MTRIAD) to request products in this manner.
  - **SBN Channel.** The SBN Channel for the products you want to retrieve (GOES, NOAAPORT\_OPT, NWSTG, and NWSTG2).
  - **Start Date/Time and End Date/Time.** The time period (range) for which you want to retrieve products (i.e., the time the product was stored at the NCF). The **NCF Archive GUI** supports numerous DTG formats. It assumes times are in GMT. Some examples of operative DTG formats include the following:
    - 6/08/10 00:00:00Z
    - 6/08/10 11:31:20GMT
    - June 08, 2010
    - 11:30
  - **Max Products.** The maximum number of products you want returned. This can be left blank to use the default (20), or you can specify the number of products to be returned. There are limits on the number of products returned.

**NOTE:** The **NCF Archive GUI** allows you to use asterisks (\*) as wildcards (e.g., SAUS\* or SAUS31 KWBC\*). The **Help** feature explains this and provides examples. Exhibit 23.2-3 depicts the **Help** window for this screen. User-friendly help menus are available throughout this application.

**Select:** **Send** from the **Request Actions** section of the **Archive Request** window

- If your request exceeds the product limit, an information window pops up. This window gives you the option of accepting the default number of products. Select **OK** to continue.
- Displays **Send Confirmation** window with your archive request ID (e.g., TBDW-26369).

**Select:** **OK** on the **Send Confirmation** window

- Transmits your request to the NCF.
- Displays the **NCF Archive** window showing that the message was transmitted to the NCF.

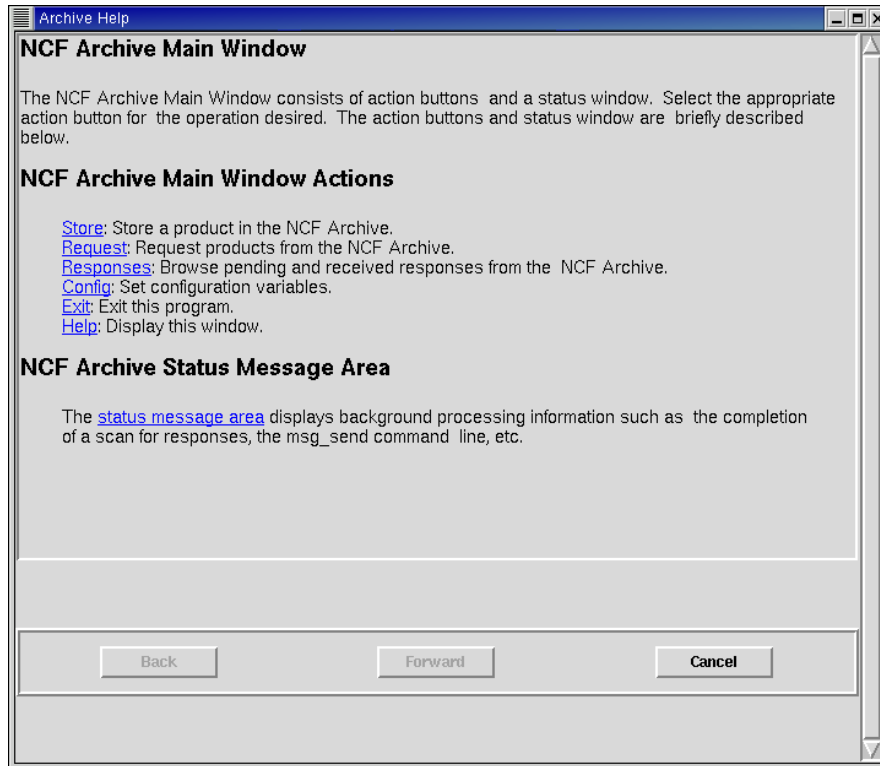
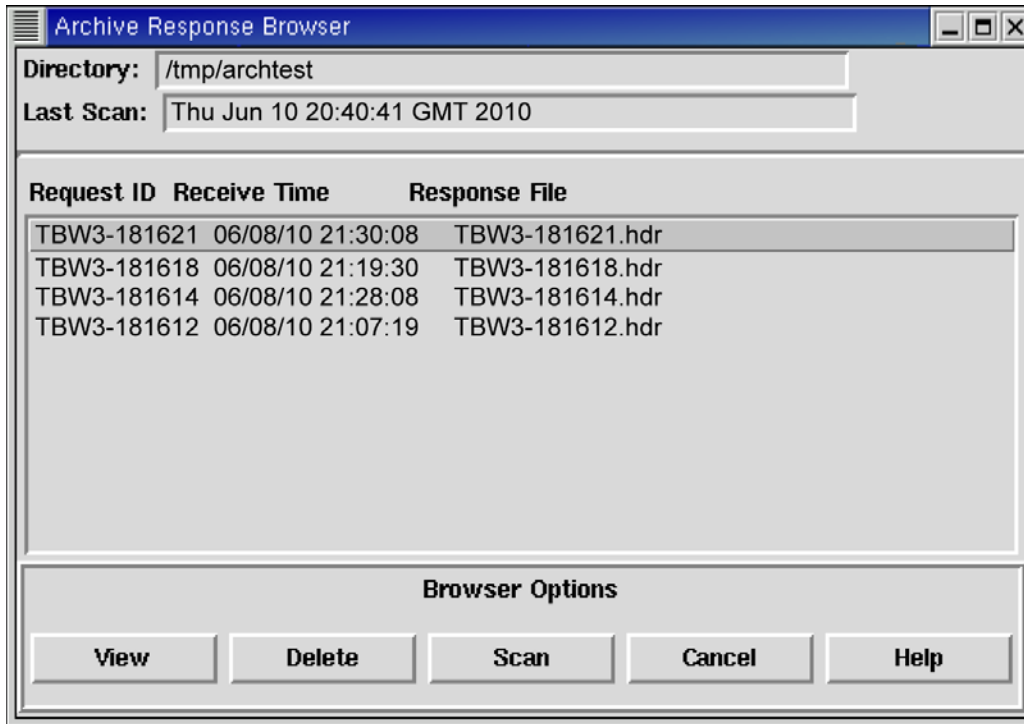

**Exhibit 23.2-3. Archive Help Screen for Archive Request Window**

You can monitor the status of your request using the **Archive Response Browser**, launched by clicking on **Responses**. Refer to Exhibits 23.2-4 and 23.2-5. Both completed and outstanding requests are displayed. Outstanding requests have asterisks (\*\*\*) across the **Receive Time** and **Response File** columns. When the requested products have arrived, the **Archive Browser**, **Receive Time**, and **Response File** fields are updated. All requests are displayed in the **Archive Response Browser** until they are deleted.

**NOTE:** Selecting the **Delete** button in the **Archive Response Browser** removes the request from the browser and deletes its query, header, and any retrieved products from the temporary store directory if the **arch\_gui** was launched from the data server.

**NOTE:** The directory in which the retrieved products have been placed is reflected in the top part of the **Archive Browser** screen. Be sure to use a **/tmp** directory!



**Exhibit 23.2-4. Archive Response Browser Window (All Requests Completed)**

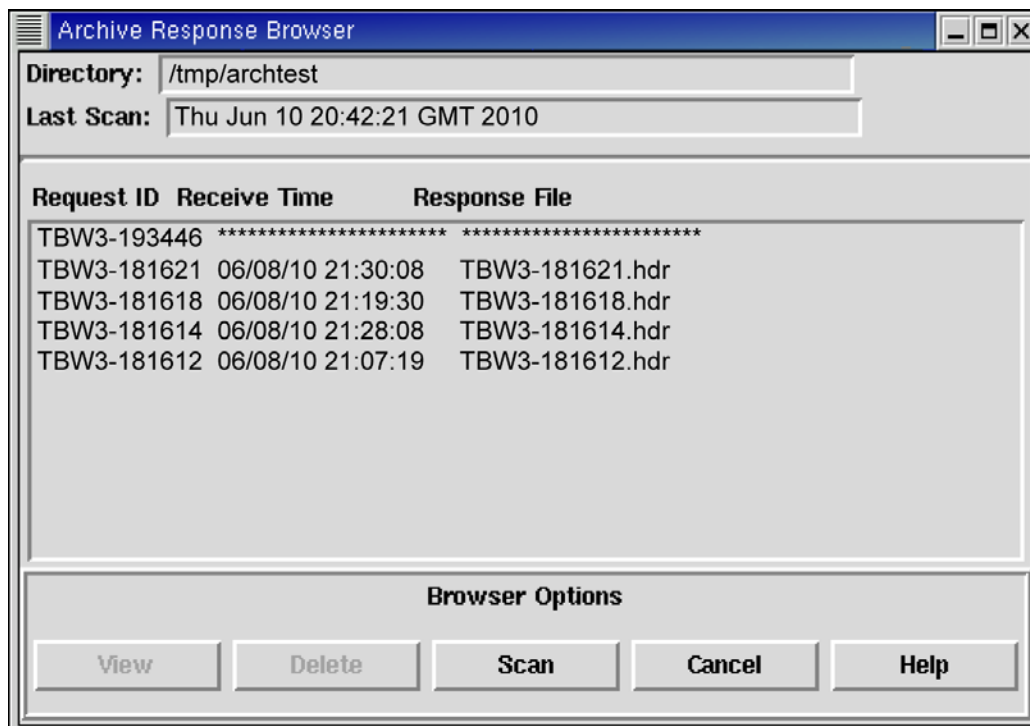

**Exhibit 23.2-5. Archive Response Browser Window (with Both Completed and Outstanding Requests)**

To view the products retrieved from the **NCF Archive**,



- Select:** The desired request from the **Archive Browser**
- Highlights the desired request.
- Select:** **View from Browser Options** in the **Archive Browser**
- Displays the Archive data for first 200 matches. Refer to Exhibit 23.2-6.
  - Displays the maximum number of products and the number of matches in the request window.
  - Adjusts the start and end times to narrow or refine your search.
  - Displays each product's file name in the **Path** column. The retrieved products are numbered sequentially.

The screenshot shows a window titled "TBDW-181621" with the following fields:

- Request ID: TBW3-181621
- WMO Header: (empty)
- NNNXXX: SWROK
- Start Date/Time: Tue Jun 8 00:00:00 GMT 2010
- End Date/Time: Tue Jun 8 21:00:00 GMT 2010
- Max Products: 10
- Total Matches: 42

Below the fields is a table with the following columns: Channel, SBN\_seqno, WMO\_header, NNNXXX, and Path.

Channel	SBN_seqno	WMO_header	NNNXXX	Path
NMC	130614473	ASUS44 KOUN 172010	SWROK	TBW3-181621.001
NMC	130607556	ASUS44 KOUN 172000	SWROK	TBW3-181621.002
NMC	130571096	ASUS44 KOUN 171910	SWROK	TBW3-181621.003
NMC	130564439	ASUS44 KOUN 171900	SWROK	TBW3-181621.004
NMC	130532465	ASUS44 KOUN 171810	SWROK	TBW3-181621.005
NMC	130525628	ASUS44 KOUN 171800	SWROK	TBW3-181621.006
NMC	130494301	ASUS44 KOUN 171710	SWROK	TBW3-181621.007
NMC	130483145	ASUS44 KOUN 171700	SWROK	TBW3-181621.008
NMC	130459238	ASUS44 KOUN 171610	SWROK	TBW3-181621.009
NMC	130452156	ASUS44 KOUN 171600	SWROK	TBW3-181621.010

At the bottom of the window is a "Response Options" section with buttons for Display, Request, Acquire, Delete, Cancel, and Help.

Exhibit 23.2-6. Request Window

**NOTES:**

- Products listed in the request window that do not have a path name have not been retrieved, but they are available and can be requested. If you want one of these products, highlight it and select the **Request** button at the bottom of the window to initiate a new request to the NCF for that specific data/product. This is a new request, with its own **Request ID**, so you must return to the **Archive Response Browser**. Highlight this new request to open a new window in which that retrieved product will be listed

- The **Acquire** button allows you to store products to the database. The **NCF Archive Actions** window will display a message indicating that the file has been sent to the **acqserver** on the primary DX. An example is shown in Exhibit 23.2-7 (the appropriate text is highlighted).
- The **Display** button is not grayed out but you will receive a “not yet implemented” dialog box if you select it. It will be enabled in a later release and will allow you to display products on D2D and the Text Browser.
- The **Delete** button may be used to delete products from the request window. Selecting the **Delete** button removes the product both from the **Request Window** and from the temporary store directory if the **arch\_gui** was launched from the data server.

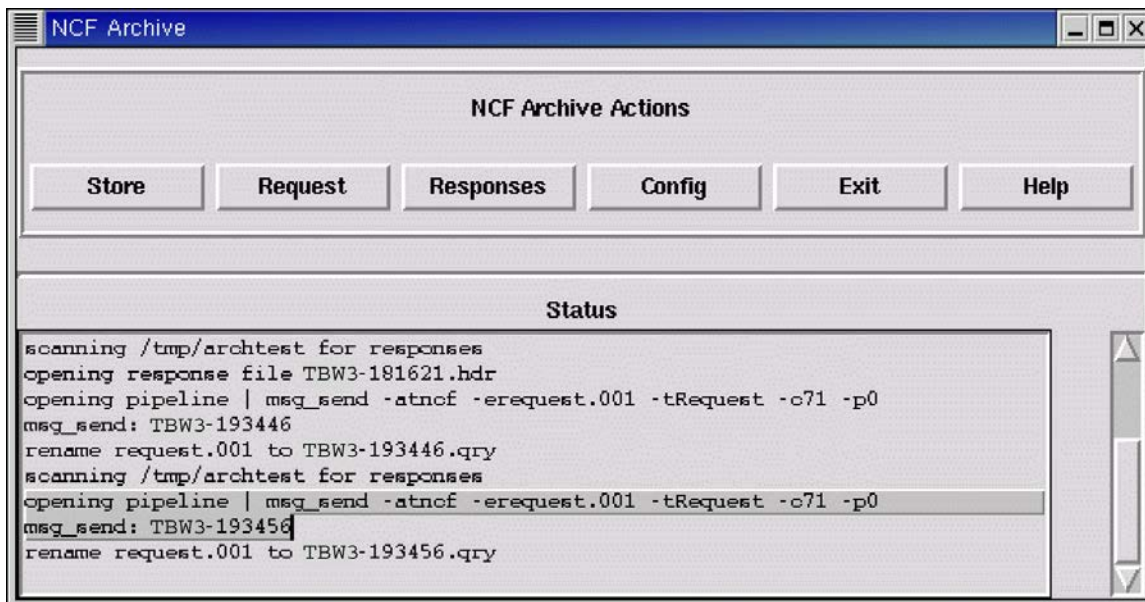

Exhibit 23.2-7. NCF Archive Actions Window

### 23.3 Displaying Retrieved Archive Products

The display function of the NCF Archive is not currently implemented because this application was developed as a “proof of concept” and was not originally intended to be deployed to the field. However, retrieved text products can be displayed by using the **cat** or **more** commands in a Terminal window on any workstation.

In the same Terminal window from which you launched the **NCF Archive GUI**,

- TYPE:** `pwd`
- Check to ensure you are in the temporary directory in which the retrieved products were placed. If you are not in this directory, use the **cd** command to change to it.
- TYPE:** `ls -l`
- Displays a list of all the retrieved products. The file name format is **<device-requestID.prodNumber>** (e.g., TBDW-

26369.001, TBDW-26369.002), like the following sample output:

```
-rw-rw-rw- 1 smithel  fxalpha      226 Jun  8 17:31 TBW3-26369.cry
-rw-rw-rw- 1 root      sys        35568 Jun  8 17:33 TBW3-26369.hdr
-rw-rw-rw- 1 root      sys        2699 Jun  8 17:33 TBW3-26369.001
-rw-rw-rw- 1 root      sys         116 Jun  8 17:33 TBW3-26369.002
-rw-rw-rw- 1 root      sys         235 Jun  8 17:33 TBW3-26369.003
-rw-rw-rw- 1 root      sys         119 Jun  8 17:33 TBW3-26369.004
-rw-rw-rw- 1 root      sys         157 Jun  8 17:33 TBW3-26369.005
-rw-rw-rw- 1 root      sys        2607 Jun  8 17:33 TBW3-26369.006
-rw-rw-rw- 1 root      sys         140 Jun  8 17:33 TBW3-26369.007
-rw-rw-rw- 1 root      sys         116 Jun  8 17:33 TBW3-26369.008
-rw-rw-rw- 1 root      sys         113 Jun  8 17:33 TBW3-26369.009
-rw-rw-rw- 1 root      sys         125 Jun  8 17:33 TBW3-26369.010
```

Use the **cat** or **more** commands to view a specific text product.

**TYPE:**        **cat** <RequestID.prodNumber>

or

**TYPE:**        **more** <RequestID.prodNumber>

- Where <**RequestID.prodNumber**> is the text product to be retrieved (i.e., enter **cat TBW3-26369.007** from the preceding example).
- Displays the retrieved text product in the Terminal window.

**NOTE:** The asterisk wild card can be used to view more than one product (e.g., **more TBDW-26369\***), but it will return a lot of data. It is strongly recommended that you use the **more** command in some capacity to view multiple products.

## 23.4 Changing NCF Archive Configuration at a Site

Click the **Config** button on the main menu to change configuration options. A maximum of 20 products in **Max Products** and a maximum of 200 lists in **Max List Entries** can be selected. There is no predefined maximum on the scan interval; however, the users probably will not want to increase the default.

- ▶ To Change NCF Archive Configuration at a Site

**Select:**        **Config** button from the **NCF Archive** window

- Displays the **Archive Config** window; refer to Exhibit 23.4-1.
- The configuration menu allows you to change configuration options, as shown in Exhibit 23.4-1.

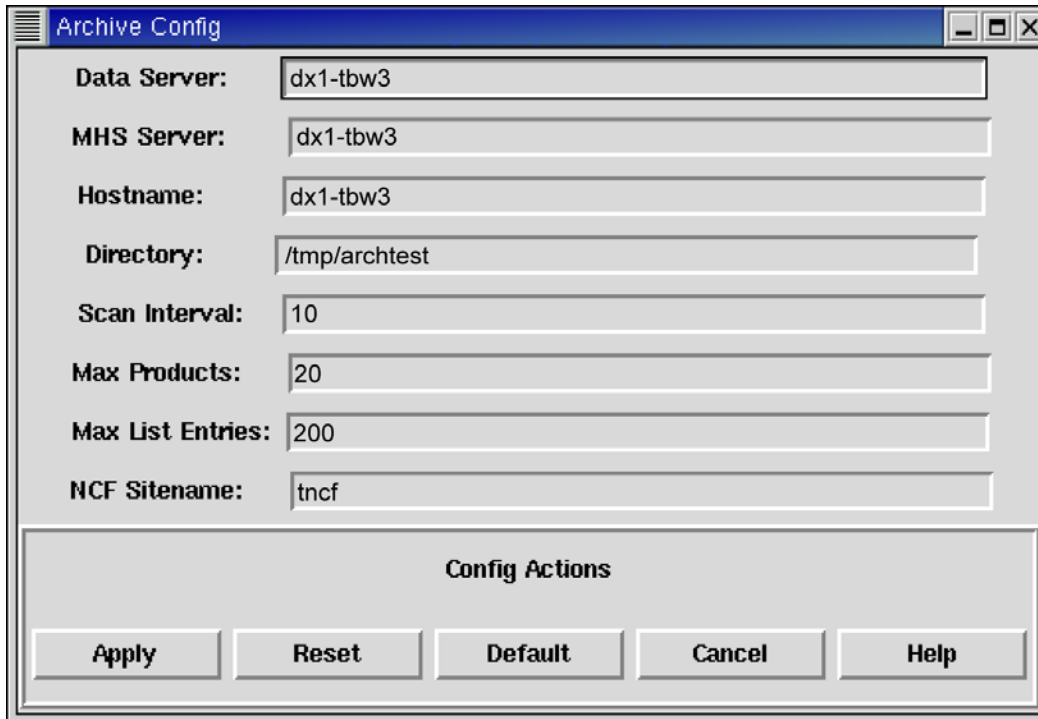

The screenshot shows a window titled "Archive Config" with the following fields and values:

Field	Value
Data Server:	dx1-tbw3
MHS Server:	dx1-tbw3
Hostname:	dx1-tbw3
Directory:	/tmp/archtest
Scan Interval:	10
Max Products:	20
Max List Entries:	200
NCF Sitename:	tncf

Below the fields is a section titled "Config Actions" containing five buttons: Apply, Reset, Default, Cancel, and Help.

Exhibit 23.4-1. Archive Config Window in NCF Archive

## **Chapter 24**

### **Data Archive Server**

## Chapter 24. Data Archive Server

### Table of Contents

	<i>Page</i>
24.1 WFO Archive Server .....	1
24.2 RFC Archive Server.....	1

This chapter describes the data archivers for the WFOs and the RFCs.

### 24.1 *WFO Archive Server*

The WFO Archive Server (WAX) is only used for tape backup. It runs the weekly nas backup script because the tape device is connected to it. Please refer to Section 16.3 of the *AWIPS CAVE-D2D User's Manual* for information on archiving and archive case creation.

### 24.2 *RFC Archive Server*

The RFC Archive Server (RAX) supports the RFC mission of requiring collection and analysis of hydrologic data over much larger areas than the typical WFO. Because of a lack of storage space, much of the hydrologic data available from field collection sites historically has not been stored on the HP Data Servers. Thus there was no opportunity to process it. The RFC Archive Server addresses both of these issues. RAX provides additional disk storage capacity to allow this previously unstored data to be stored in a new database, and it also provides the processing power and associated software to process large amounts of hydrologic data. RAX is not a redundant server; however, it does have an SCSI RAID Level 5 storage array (Ultra32, ServeRAID-5i SCSI Controller). RAID-5 allows for a single drive to fail at any given time without any data loss. It also has a DVD Drive/Recorder (DVR-A04 Pioneer DVR), and data can be selected and moved to more permanent storage or written to a CD or DVD.

**NOTE:** Only DVD-R and CD-R media should be used to archive data. DVD+R media is no longer supported.

The hardware specifications are as follows:

- Dedicated system, Rack mounted
- Intel Xeon 2.4GHz/400MHz
- 2 - 512MB PC2100 CL2.5 ECC DDR SDRAM RDIMM
- Ultra 320, ServeRAID-5i SCSI Controller (single channel)
- Six 73.4GB 10K rpm Ultra160 SCSI HS
- 10/100/1000 Port Ethernet Server Adapter
- Tape drive - 40/80GB DLTVS HH Int. SCSI Drive (Half-High) and Ultra 160 PCI Adapter(required for Tape device when using ServeRAID5i)
- DVD Drive/Recorder - DVR-A04 Pioneer DVR).

**Chapter 25**  
**AWIPS II/EDEX Administration Guide**



## Chapter 25. AWIPS II/EDEX Administration Guide

### Table of Contents

	<i>Page</i>
25.1 Document Conventions and Assumptions .....	1
25.2 AWIPS II Deployment.....	2
25.2.1 EDEX Deployment Considerations .....	2
25.2.2 Operational Considerations .....	5
25.2.3 Additional AWIPS II Software Packages .....	5
25.3 Basic Data Flow Concepts .....	7
25.3.1 Basic Data Flow for ORPG/SPG Products .....	9
25.4 System Management.....	10
25.4.1 Managing EDEX on the DX3/4 Cluster.....	10
Example 25.4.1-1: Checking Status of EDEX Processes .....	11
Example 25.4.1-2: Starting EDEX Processes .....	12
Example 25.4.1-3: Starting EDEX Process (When Already Running) .....	12
Example 25.4.1-4: Using ps to Check for EDEX Processes.....	13
25.4.2 Managing Software on CPSBN1/21/2 .....	17
25.4.3 Managing Software on DX1/2.....	23
25.4.4 Managing Software on PX1/2.....	28
25.4.5 Managing Software on DX3/4 .....	28
25.5 System Configuration .....	34
25.6 EDEX Process Log and Log Format .....	34
25.6.1 Process Logs.....	34
25.6.2 Additional Log Files.....	34
25.6.3 Process Log File Naming Convention .....	34
Example 25.6.3-1: Log File Names .....	35
25.6.4 Log Formats .....	35
25.6.5 EDEX Logging Levels.....	35
Example 25.6.5-1: Monitoring EDEX Process Log for Errors.....	36
25.6.6 Controlling Logging Levels .....	36
25.7 EDEX System Monitoring.....	36
25.7.1 Using Standard Linux Tools .....	37
Example 25.7.1-1: Determining the EDEX Version .....	38
Example 25.7.1-2: Determining EDEX Status .....	38
Example 25.7.1-3: Determining EDEX Process Restarts .....	39
Example 25.7.1-4: Determining Available Data Types from Ingest .....	40
Example 25.7.1-5: Monitoring Data Ingest .....	45

Example 25.7.1-6: Monitoring Data Ingest Latency .....	47
Example 25.7.1-7: Monitoring Ingest Failures .....	50
Example 25.7.1-8: Verifying EDEX Ready to Execute .....	51
Example 25.7.1-9: Monitoring General EDEX Server Status .....	52
Example 25.7.1-10: Monitoring Just the EDEX Processes .....	53
25.7.2    Using the JConsole Tool .....	54
Example 25.7.2-1: Using JConsole to Monitor an EDEX Process .....	55
Example 25.7.2-2: Using JConsole to Examine Data Ingest Status .....	57
Example 25.7.2-3: Using JConsole to Monitor Request Status .....	60
Example 25.7.2-4: Using JConsole to Change Logging Thresholds .....	61
25.8    Other EDEX-Related Monitoring .....	64
25.8.1    Monitoring the Database .....	64
Example 25.8.1-1: Identifying the Database Used by EDEX .....	64
Example 25.8.1-2: Verifying that PostgreSQL Server Is Running .....	65
Example 25.8.1-3: Verifying Database Availability .....	66
Example 25.8.1-4: Determining Data Type Tables in Metadata Database .....	67
Example 25.8.1-5: Determine Latest Insertion Time of GRIB Metadata .....	68
Example 25.8.1-6: Determining Database Session Information Using psql .....	68
Example 25.8.1-7: Determining Data Type Tables in Metadata Database (Revisited) .....	71
25.8.2    Monitoring the Data Store .....	74
Example 25.8.2-1: Determining the Disk Space Used by the Data Store .....	74
Example 25.8.2-2: Modifying Data Retention Time .....	75
Example 25.8.2-3: Determining Available Data Types (in the Data Store) .....	76
25.8.3    Monitoring QPID .....	80
Example 25.8.3-1: Verifying QPID Execution .....	80
Example 25.8.3-2: Monitoring QPID Execution .....	81
Example 25.8.3-3: Monitoring QPID Logging .....	81
25.8.3.1    QPID Monitoring Tools .....	83
Example 25.8.3.1-1: Determining the Status of the QPID Cluster .....	84
Example 25.8.3.1-2: Monitoring QPID Queue Status .....	85
Example 25.8.3.1-3: Monitoring Individual QPID Queues .....	86
25.8.4    Monitoring IP Virtual Server (IPVS) .....	88
Example 25.8.4-1: Verify/Monitor pulse Operation .....	89
Example 25.8.4-2: Verify/Monitor lvsd Operation .....	90
Example 25.8.4-3: Verify/Monitor nanny Operation .....	91
Example 25.8.4-4: Monitoring IPVS Using the ipvsadm Tool .....	93
25.8.5    Monitoring the LDM .....	96
Example 25.8.5-1: Verifying LDM Operation on the CP Cluster .....	96

Example 25.8.5-2: Monitoring LDM Data Flow on the CP Cluster.....	97
Example 25.8.5-3: Monitoring LDM Log on the CP Cluster.....	101
25.8.6    Monitoring Radar Server.....	101
Example 25.8.6-1: Verifying Radar Server Operation .....	102
Example 25.8.6-2: Monitoring RCM Performance Using top.....	102
Example 25.8.6-3: Monitoring RCM Using JConsole.....	103
Example 25.8.6-4: Monitoring the Radar Server Log .....	104
25.8.7    Monitoring EDEX Subscription Script Running .....	106
Example 25.8.7-1: Identifying Registered Subscriptions – Using psql.....	106
Example 25.8.7-2: Identifying Registered Subscriptions – Using the CLI .....	110
Example 25.8.7-3: Identifying Text DB Triggers – Using the CLI.....	112
Example 25.8.7-4: Determining if Subscriptions Are Firing from the EDEX Process Logs .....	114
Example 25.8.7-5: Determining if Subscriptions Are Firing Using JConsole .....	115
25.8.8    Monitoring EDEX Smart Init Processing.....	117
Example 25.8.8-1: Monitoring the EDEX Ingest Process Log for Smart Init Processing.....	117
Example 25.8.8-2: Monitoring Smart Init Calculations (in the EDEX ingest process log).....	118
Example 25.8.8-3: Monitoring Smart Init Using JConsole .....	119
25.9    HDF5 Tools .....	122
25.9.1    HDF5 Tools - Procedures.....	122
Example 25.9.1-1: The h5ls Tool .....	123
Example 25.9.-2: The h5dump Tool.....	123
Example 25.9.1-3: The h5stat Tool.....	123
Example 25.9.1-4: The h52gif Tool.....	124
25.9.2    The $\mu$ Engine Web Test Driver .....	124
Example 25.9.2-1: Retrieving a Satellite Image via the $\mu$ Engine Web Test Driver.....	124
25.10  CAVE/Workstation Setup Considerations.....	126
25.10.1  CAVE Startup Modes.....	126
25.10.2  Cave Installation.....	126
25.10.3  CAVE Startup .....	127
Example 25.10.3-1: Validating the LX VIZ Installation .....	128
Example 25.10.3-2: Validating the XT VIZ Installation .....	129
Example 25.10.3-3: Cave Connection Problems .....	129
25.11  Verifying That AWIPS II Processes Are Running .....	131
25.12  EDEX Startup and Shutdown Procedures.....	137
25.12.1  AWIPS II/EDEX Software Dependencies .....	137
25.12.2  Starting AWIPS II/EDEX Software.....	138
25.12.3  Verifying Software Execution.....	140
25.12.4  Stopping EDEX Software .....	142

25.12.5	Verifying Software Shutdown.....	143
25.12.6	Alternative Shutdown Scenarios .....	144
25.13	Troubleshooting Basic AWIPS II Data Flow .....	149
Example 25.13-1:	Troubleshooting Satellite Data Flow.....	150
Example 25.13-2:	Troubleshooting Radar Data Flow .....	151

### List of Exhibits

Exhibit 25.2.1-1.	AWIPS II EDEX Installation.....	2
Exhibit 25.2.1-2.	EDEX Install Structure .....	3
Exhibit 25.3-1.	Basic SBN Data Flow .....	8
Exhibit 25.3.1-1.	Local Radar Data Flow in AWIPS II.....	9
Exhibit 25.7.1-1.	Basic top Display .....	53
Exhibit 25.7.1-2.	Top Display with Selected Processes .....	54
Exhibit 25.7.2-1.	Initial JConsole Display.....	56
Exhibit 25.7.2-2.	JConsole MBean Tab, Initial Display.....	57
Exhibit 25.7.2-3.	JConsole MBean Tab with org.apache.camel Expanded.....	58
Exhibit 25.7.2-4.	Partial Listing of Camel Routes.....	59
Exhibit 25.7.2-5.	Radar Decoder Route with Attributes Displayed .....	59
Exhibit 25.7.2-6.	EDEX Request in JConsole with Routes Expanded.....	60
Exhibit 25.7.2-7.	Micro Engine Http Thrift Bean Attributes.....	61
Exhibit 25.7.2-8.	EDEX Logging Controls via JConsole.....	62
Exhibit 25.7.2-9.	Set Level Operation of the Logging MBean.....	62
Exhibit 25.7.2-10.	Changing a Logging Level .....	63
Exhibit 25.8.3-1.	Top Display Monitoring QPID .....	81
Exhibit 25.8.3.1-1.	Typical Output of qpid-stat for Queue Monitoring .....	85
Exhibit 25.8.3.1-2.	Typical Output of qpid-stat Monitoring Ingest Queues.....	86
Exhibit 25.8.3.1-3.	Typical Output of qpid-queue-stats Monitoring Ingest Queues .....	87
Exhibit 25.8.4-1.	Client Interaction with CAVE via IPVS.....	88
Exhibit 25.8.4-2.	Basic Hierarchy of Tools in IPVS .....	89
Exhibit 25.8.4-3.	Top Output Monitoring pulse .....	90
Exhibit 25.8.4-4.	Top Output Monitoring lvsd.....	91
Exhibit 25.8.4-5.	Top Output Monitoring nanny .....	92
Exhibit 25.8.4-6.	Monitoring IPVS Connections Using watch .....	94
Exhibit 25.8.4-7.	Monitoring IPVS Connection Statistics Using watch.....	95
Exhibit 25.8.4-8.	Monitoring IPVS Rate Statistics Using watch.....	96
Exhibit 25.8.6-1.	Using top to Monitor the Radar Server.....	103
Exhibit 25.8.6-2.	Using JConsole to Monitor Radar Server .....	104

Exhibit 25.8.7-1. Sample Result of Timer Type Query .....	109
Exhibit 25.8.7-2. Sample Result of System Runner Query .....	110
Exhibit 25.8.7-3. Data Arrival Script Runner Bean Attributes .....	116
Exhibit 25.8.8-1. gfe-camel-spring Route in JConsole .....	120
Exhibit 25.8.8-2. smartInitTrigger Bean Attributes in JConsole .....	121
Exhibit 25.8.8-3. smartInitWork Bean Attributes in JConsole .....	121
Exhibit 25.8.8-4. JConsole Bean Attributes with Graphs .....	122
Exhibit 25.10.3-1. CAVE Connectivity Error When Alert VIZ Is Not Available.....	130
Exhibit 25.10.3-2. CAVE Connectivity Error When Alert VIZ Is Available.....	130
Exhibit 25.10.3-3. No Alert VIZ, Localization Available .....	131
Exhibit 25.12.1-1. AWIPS II Server Software Dependencies .....	138
Exhibit 25.13-1. Basic Data Flow Troubleshooting .....	150
Exhibit 25.13-2. Expanded EDEX Data Flow .....	151

### List of Tables

Table 25.2.1-1. EDEX Installed Directories .....	3
Table 25.2.2-1. Available EDEX Operational Modes .....	5
Table 25.2.3-1. Additional AWIPS II Software Packages.....	6
Table 25.4.1-1. edex_camel Command Line Options .....	10
Table 25.4.1-2. EDEX Process Log Locations .....	11
Table 25.4.2-1. CPSBN1/2 Services.....	17
Table 25.4.3-1. AWISP II Services on DX1/2.....	23
Table 25.4.3-2. DX1/2 Mounts on the DAS and NAS .....	23
Table 25.7.1-1. Useful Tools for Monitoring EDEX.....	37
Table 25.7.2-1. EDEX JConsole Ports.....	55
Table 25.8.3.1-1. Basic QPID Tools.....	84
Table 25.8.5-1. Selected LDM Feed Types .....	99
Table 25.8.7-1. Subscriptions Table Fields .....	107
Table 25.8.7-2. Basic Flags for Subscription CLI Tool.....	111
Table 25.8.7-3. Script Runners by EDEX Process .....	114
Table 25.9.1-1. Useful HDF5 Tools from the HDF Group .....	122
Table 25.10.1-1. CAVE Startup Modes.....	126
Table 25.10.2-1. Contents of VIZ Install Directory.....	127
Table 25.12.3-1. Expected Output from ps Commands.....	141

This AWIPS II/EDEX Administration Guide provides information on the implementation of AWIPS II within the existing AWIPS system. It is intended as a resource for AWIPS System Managers who need a quick source of information for use in diagnosing and administering the AWIPS II software.

Sections 25.1, 25.2 and 25.3 describe conventions used throughout the chapter, outline AWIPS II deployment considerations, and address the basic data flow concepts respectively. The remaining sections focus on specific procedures for monitoring EDEX (the Environmental Data Exchange).

The procedural sections include a series of “examples,” which illustrate techniques that can be used to monitor or manage the AWIPS II/EDEX processes. The examples are broken down into “recipes,” which are actually step-by-step procedures (or “recipes”) for performing a specific task.

As you review the specific EDEX monitoring procedures presented here, remember that the following steps provide a general guide to checking EDEX operation.

- Check for running EDEX services.
- Check system log file for exceptions.
- Check for data ingest.
- Check for products in database.
- Check CAVE operation.

Finally, keep in mind that, unlike many of the diagrams presented elsewhere in the SMM, the diagrams in this chapter should be considered *conceptual*. For example, a diagram may have a single box representing a cluster.

### 25.1 Document Conventions and Assumptions

In order to provide a consistent presentation of information that reflects the known state of the AWIPS II system, several conventions have been adapted for use in this administration guide. In addition, assumptions were made about the AWIPS II installation environment. A list of these assumptions and conventions follows.

1. It is assumed that AWIPS II software on a server is installed into /awips2.
2. It is assumed that EDEX software is being installed on DX3 and DX4. On fielded systems, the server names may be dx3-xxx and dx4-xxx, where xxx is the site identifier.
3. In Examples involving user interaction with a server, it is assumed that the user will open a terminal and log into the server. A generic prompt (\$) is used. User inputs are shown in an *italic Courier New* font; computer output is shown in a plain font, also *Courier New*.
4. All Examples utilize the Linux ssh utility to perform remote logins to the server; other remote login tools are available, for example, putty. If another tool is used, the Examples may need to be adjusted.

5. When you log on to a server, the server returns a banner for display by the client. To save space in the recipes, this banner is omitted from listings.
6. To simplify command line interactions, it is assumed that all tools are located on the user's PATH. If that is not the case, command lines should be adjusted.

## 25.2 AWIPS II Deployment

EDEX is deployed to DX3 and DX4. Additional EDEX-related components are installed on other servers.

### 25.2.1 EDEX Deployment Considerations

On each DX3/4 box, the deployment consists of a set of directories under /awips2, as shown in Exhibit 25.2.1-1.

```
/awips2
|-- GFESuite
|-- adapt
|-- edex
|-- fxa
|-- java
|-- notification
|-- psql
|-- python
|-- qpid
|-- tools
|-- yajsw
(On DX 3/4)
```

**Exhibit 25.2.1-1. AWIPS II EDEX Installation**

**NOTE:** There is a single installation of EDEX; all EDEX instances run from this single installation. This increases operational flexibility while simplifying installation.

The installation structure under the *edex* directory is shown in Exhibit 25.2.1-2.

```

/awips2/edex
|-- bin
|-- conf
|-- data
|-- etc
|-- lib
|-- logs
|-- webapps
|-- scripts
(On DX 3/4)

```

**Exhibit 25.2.1-2. EDEX Install Structure**

From an administration/monitoring standpoint, the important directories are *bin*, *conf*, *data*, and *logs*. For a list of specific files of interest in this installation tree, see Table 25.2.1-1.

**Table 25.2.1-1. EDEX Installed Directories**

Directory	File	Description/Use
bin		Contains the basic scripts used to run the EDEX processes. The contents of this directory are not normally modified in the field.
	start.sh	Basic startup script for EDEX. Normally, this file will not be changed once the system has been installed.
	setup.env	Basic localization information for EDEX.
	<process>.pid	Contains the Product Identifier (PID) of the wrapper instance controlling an EDEX process. (<process> represents the name of the EDEX process; valid process names are <i>ingestDat</i> , <i>ingestGrib</i> , <i>ingest</i> , and <i>request</i> . These files exist only when the EDEX processes are executing.
	versions.sh	Script to query the RPM database and return Name, Version, Release ID, Build Machine, and Install Date for AWIPS II RPMs.
	Daminfotranslator.sh	The dam_info.txt file from AWIPS I has been replaced by a metadata table named “mapdata.customlocations” in AWIPS II. In order to populate this table the user must run this script located on the EDEX server
	findEmptyLocalizationDirs.sh	
conf		Contains basic configuration for the EDEX processes.
	banner.txt	Contains the <i>banner</i> logged at each EDEX startup. The banner can be used to identify the installed version of EDEX.
	modes.xml	Defines the EDEX operational modes: <i>ingestDat</i> , <i>ingestGrib</i> , <i>ingest</i> , and <i>request</i> . This file should not be modified; changing this file will adversely affect EDEX operation.
	logback-ingest.xml,	Defines EDEX logging.



Directory	File	Description/Use
	logback-registry.xml logback-dataprovideragent.xml and logback.xml logback-edex-appenders.xml logback-edex-limited-loggers.xml logback-edex-loggers.xml logback-edex-properties.xml logback.xml logback-request.xml	
data		Directory tree that contains the files utilized and/or generated by the EDEX processes. In the EDEX cluster, this directory is mounted to a shared directory (on the NAS).
	archive, gfe, manual, outgoing, sbn, static, uEngine, fxa, hdf5, ndm, processing, share, tmp, utility, registrySubscriptionBackup	All files in the data directory tree are visible to all servers in the EDEX cluster. Directories contain the data used and/or generated by the EDEX processes. Directories under data/hdf5 contain the HDF5 files, which hold data ingested by the EDEX Ingest process. These directories may be monitored to get a rough idea of what data is being ingested.
etc	centralRegistry.sh devRegistry.sh ingest.sh request.sh datadeliveryonly.sh ingestDat.sh profiler.sh dataprovideragent.sh ingestGrib.sh registry.sh default.sh ingestHydro.sh requestHydro.sh	Scripts, which are sourced by start.sh to customize EDEX startup:
logs	--	Contains logs files for the EDEX processes. See EDEX Process Logs for more information on the logs.

Directory	File	Description/Use
lib	--	Library for dependencies, library illusion, native and plugins.
scripts		HazardServices

### 25.2.2 Operational Considerations

EDEX has been re-engineered to allow it to run multiple configurations out of a single installation. This is done via command line switches. EDEX currently supports four command line switches – *ingest*, *ingestGrib*, *ingestDat*, and *request*. In operational settings, the syntax for starting EDEX is

```
/awips2/edex/bin/start.sh [mode]
```

The operational modes currently supported are shown in Table 25.2.2-1.

**Table 25.2.2-1. Available EDEX Operational Modes**

EDEX Mode	Token	Description
Ingest	ingest	Starts an EDEX (radar, satellite, text, gen_areal_ffg, shef-performance, smartInit, archive, GFEPPerformance, archive, activeTableChange, performance, gen_areal_qpe, hibernate) process that supports Ingest operations.
DAT Ingest	ingestDAT	Starts an EDEX process that supports the ingest process for the Decision Aids Toolset (DAT).
GRIB Ingest	ingestGrib	Starts an EDEX process that supports ingest of GRIB products.
Request	request	Starts an EDEX process that supports Request operations.

If no mode is specified, a single EDEX process that supports all Ingest and Request operations is started. If an invalid mode is specified, EDEX will run long enough to generate a log for the specified (invalid) mode, but will then shut down.

Which operational modes will be used when starting EDEX depends upon the available memory on the EDEX server. The Ingest, GRIB Ingest and Request processes will always be started; the DAT Ingest process is started only on servers having at least 4 GByte of memory.

### 25.2.3 Additional AWIPS II Software Packages

In addition to EDEX installed on DX3 and DX4, AWIPS II installs additional software packages on several AWIPS servers. (See Exhibit 25.2-1.) These additional software packages provide functionality to support EDEX and are listed in Table 25.2.3-1.

**Table 25.2.3-1. Additional AWIPS II Software Packages**

Package	Server	Function
PostgreSQL*	DX1/2	Hosts the AWIPS II database, including rehosted application databases.
PyPIES	DX2	AWIPS II data store management software – performs read/write operations in the HDF5 data store.
QPID	CP1/2	Message broker – handles IPC between EDEX instances, LDM and EDEX, RCM and EDEX, EDEX and CAVE, etc.
RCM	DX1/2	AWIPS II Radar Server – provides the bridge between ORPG/SPG and EDEX ingest.
IPVS	CP1/2	IP Virtual Server – provides IP aliasing between DX3 and DX4.
LDM	CP1/2	Provides a bridge for data between the SBN and EDEX and RCM and EDEX.

*\*Postgres Database (v9.3.5): EDEX uses Postgres as the repository for storing metadata extracted during the data ingest process. The database also contains the text database, the maps database, and the hydro database.*

In a typical AWIPS II installation, the Postgres database, by default, is installed on the dx1 server under the /awips2/postgresql directory. The following is an overview of some important directories and files in the postgres installation.

- **/awips2/postgresql/bin.start\_developer\_postgres.sh** and **start\_postgres.sh**. Either of these scripts can be used to start the postgres server on a development workstation.
- **/awips2/psql**. This is the command line interface for interacting with the postgres database. A typical usage of this command to connect to the metadata database is as follows: `psql -d metadata -U awips -h dx1`. You would then enter the password for user awips, which is awips. Once connected, you are now able to interact with the database using SQL or the set of meta-commands provided by psql. Detailed documentation about using psql and psql's meta-commands can be found here: <http://www.postgresql.org/docs/9.3/static/app-psql.html>

Further documentation about the client applications in this directory can be found here: <http://www.postgresql.org/docs/9.3/static/reference-client.html>

- **/awips2/postgresql/include**. This directory contains code used internally by postgres and should not be manually modified.
- **/awips2/postgresql/lib**. This directory contains libraries used by postgres and should not be manually modified.

The /awips2/data directory on DX1 is used by postgres to store table information (schemas, tablespaces, etc.) and user configurable files. Some important directories and files contained in this directory are:

- **/awips2/data/postgresql.conf**. This file controls a number of items defining how Postgres behaves behind the scenes including memory usage, logging, and querying. Modifying items in this file can have significant performance implications. Therefore, modifications should be carefully considered. A series of

documentation explaining the various configuration items contained in this file is here: <http://www.postgresql.org/docs/9.3/static/runtime-config-file-locations.html>

- **/awips2/data/pg\_hba.conf**. This file controls client connection permissions and authentication. Detailed documentation about this file and other client authentication concerns can be found here: <http://www.postgresql.org/docs/9.3/static/client-authentication.html>
- **/awips2/data/pg\_log**. This directory contains the postgres logs. Logging behavior can be enabled/disabled and modified in the aforementioned postgresql.conf file.
- **/awips2/data/ident.conf**. This file controls PostgreSQL ident-based authentication. It maps # ident user names (typically UNIX user names) to their corresponding # PostgreSQL user names.

The complete set of documentation for Postgres 9.3 is located here: <http://www.postgresql.org/docs/9.3/static/index.html>

**PGAdmin3:** PGAdmin3 is a graphical interface to view postgres databases. Refer to the PGAdmin3 documentation for usage details: <http://www.pgadmin.org/docs/>

### 25.3 *Basic Data Flow Concepts*

EDEX is fairly agnostic as to the actual source of its data; however, there are two specific routes by which data may be delivered to EDEX:

1. The data source moves a file into the manual processing directory (manual ingest); or
2. The data source sends a message to the message broker (QPID) defining the data that is ready to process. The message contains the path to a file containing the data to ingest.

Exhibit 25.3-1 shows the basic flow of data from the Satellite Broadcast Network (SBN) to the EDEX ingest processes.

Data received over the SBN includes non-local radar products, satellite imagery, GRIB data, ASCII text-based products such as METAR, and Terminal Aerodrome Forecast (TAF) products and weather bulletins. All SBN data ingest shares the same general pattern. This general pattern is shown in Exhibit 25-3.1.

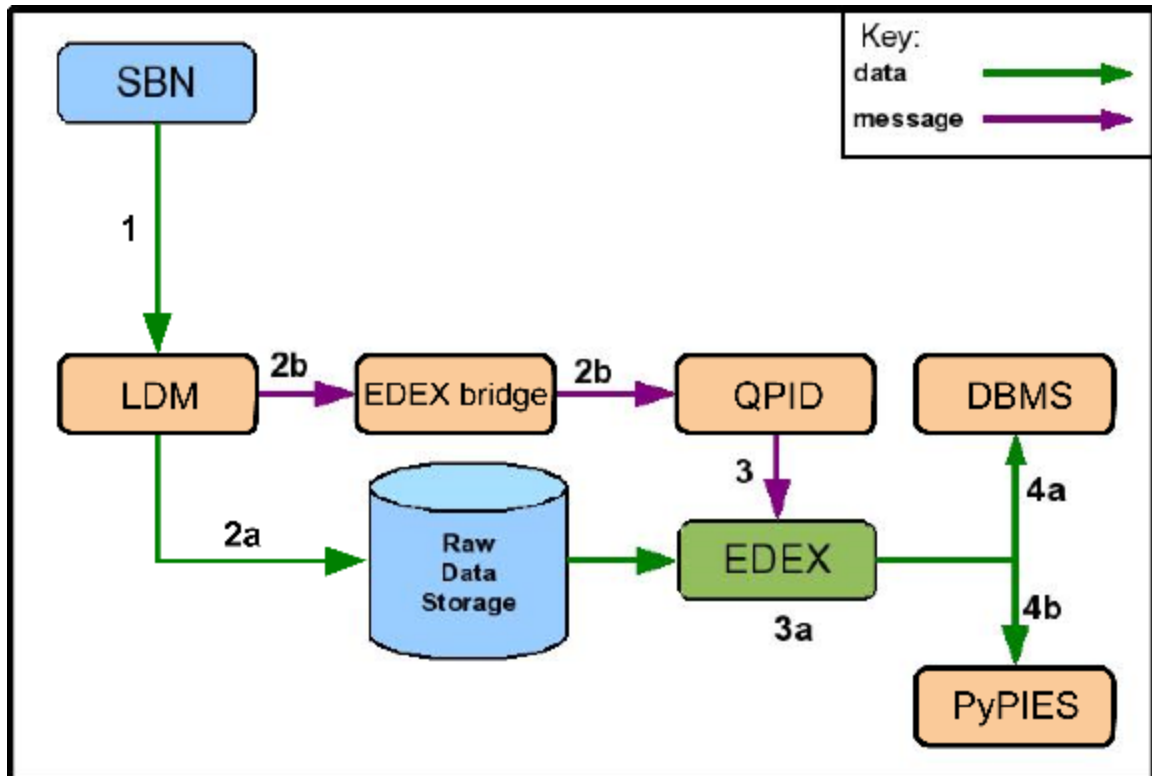

Exhibit 25.3-1. Basic SBN Data Flow

As shown in Exhibit 25.3-1:

1. Data is received from the SBN by the LDM. (Included is a sequence number to identify the data.)
2. The LDM performs two functions:
  - a. LDM writes the product as a file to Raw Data Storage.
  - b. A “data available” message is sent via the EDEX bridge to the QPID message broker.
3. The EDEX Ingest process obtains the “data available” message from QPID and determines the data decoder to use to ingest the data.
  - a. The data decoder reads the raw data from Raw Data Storage and decodes it.
4. Once decoded, the data is persisted for later retrieval.
  - a. The data is sent to the DBMS.
    - i. Information about the data is persisted to the AWIPS II metadata database.
    - ii. Some types of data, such as text products, are written to tables in the AWIPS II database.
  - b. Certain types of data (satellite imagery, radar imagery, GRIB data, and certain point data) are written to Hierarchical Data Format – 5 (HDF5) files in HDF5 data storage. This is performed via the PyPIES process on DX2.

5. In some cases, EDEX will automatically run scripts on arrival of the data.

To verify this data flow, log into the various servers in the system and examine log files to trace the data from the source to its final destination. You can also examine the database and file systems to verify that the data has been ingested.

If you discover that the data flow has been interrupted, make sure that the applications involved in the data flow are running. If one of the applications is not running, diagnose and correct the problem; then restart the application.

### 25.3.1 Basic Data Flow for ORPG/SPG Products

Local radar data is obtained from the ORPG/SPG and written to Raw Data Storage by the AWIPS II Radar Server. The Radar Server then passes a “data available” message to QPID. The basic data flow is shown in Exhibit 25.3.1-1.

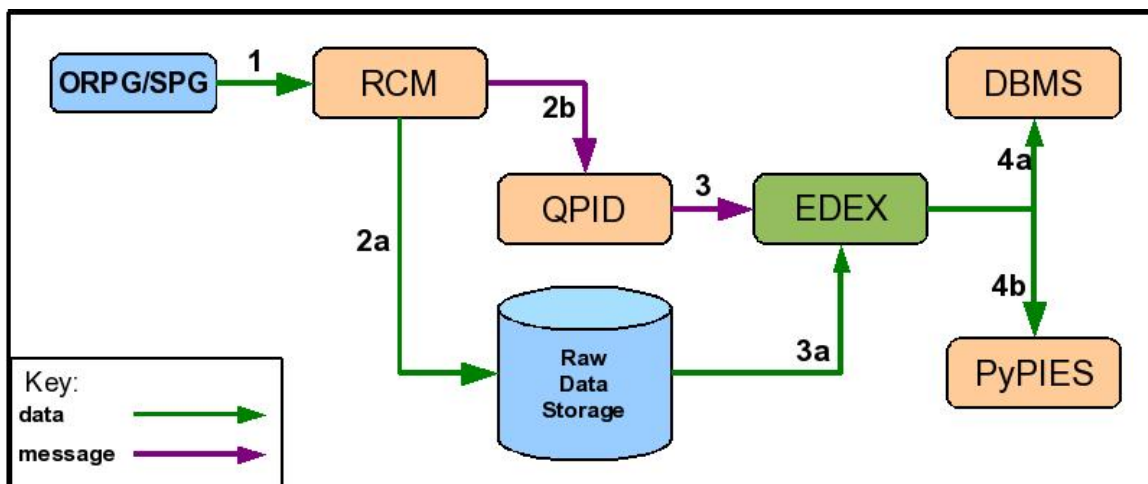

Exhibit 25.3.1-1. Local Radar Data Flow in AWIPS II

As shown in Exhibit 25.3.1-1:

1. The RCM obtains a local radar product from the ORPG/SPG.
2. The Radar Server performs two operations for the data it receives.
  - a. The Radar Server writes the product as a file to Raw Data Storage.
  - b. The Radar Server posts a “data available” message to the QPID message broker.
3. The EDEX Ingest process obtains the “data available” message from QPID and determines the data decoder to use to ingest the data.
  - a. The data decoder reads the raw data from Raw Data Storage and decodes it.
4. Once decoded, the data is persisted for later retrieval.
  - a. The data is sent to the DBMS.
    - i. Information about the data is persisted to the AWIPS II metadata database.
    - ii. Some types of data, such as text products, are written to tables in the AWIPS II database.

- b. Certain types of data, including radar imagery, are written to HDF5 files in Processed Data Storage. This is performed via the PyPIES process on DX2.

**Note:** In some cases, EDEX will automatically run scripts on arrival of the data.

To verify the local radar data flow, log into the various servers in the system and examine log files to trace the data from the source to its final destination. You can also examine the database and file systems to verify that the data has been ingested.

If you discover that the data flow has been interrupted, make sure the applications involved in the data flow are running. If one of the applications is not running, diagnose and correct the problem; then restart the application.

## 25.4 System Management

AWIPS II system management involves the control of both EDEX on the DX3/4 and the additional software packages described Section 25.2.3. This section covers basic system management for these software systems.

### 25.4.1 Managing EDEX on the DX3/4 Cluster

Once EDEX has been installed, the recommended means of control is via the `edex_camel` script, which is located in `/etc/init.d`. This script conforms to the standard interface for system control scripts:

```
/etc/init.d/edex_camel option [service [service] ...]
```

The standard options – start, stop, and restart – are supported, as are additional, mode-specific options. The options that are currently available are listed in Table 25.4.1-1.

**Table 25.4.1-1. `edex_camel` Command Line Options**

Option	Effect
start	Starts all EDEX processes
stop	Stops all EDEX processes
restart	Restarts all EDEX processes
reload	Requests a reload of all EDEX processes
status	Obtains status information for the EDEX processes

If no option is specified, a usage message is displayed. If one or more services are specified, only those services are used. For a list of available EDEX processes, see Section 25.2.2, [Operational Considerations](#).

For example, to check the status of the request instance, the command line in use is

```
/etc/init.d/edex_camel status request
```

**NOTE:** `edex_camel` controls the EDEX processes on a single server. Because of the nature of the script, it should be used only by the root user. (There is one exception to the rule, i.e., any user may use the `status` option to determine if each EDEX process is running.)

The EDEX process logs routine status messages as well as error messages. Note that EDEX keeps separate logs on DX3 and DX4; as a result, both servers logs must be examined when monitoring the system and confirming system startup and shutdown. The locations of the EDEX logs on DX3 and DX4 are listed in Table 25.4.1-2.

**Table 25.4.1-2. EDEX Process Log Locations**

Server	EDEX Process	Log Location
DX3	EDEX Ingest (radar, satellite, text, gen_areal_ffg, shef-performance, smartInit, archive, GFEPPerformance, gen_areal_qpe, unrecognized-files, productSrvRequest, performance,ohd and sportlma)	/awips2/edex/logs
DX3	EDEX DAT Ingest	/awips2/edex/logs
DX3	EDEX GRIB Ingest	/awips2/edex/logs
DX3	EDEX Request	/awips2/edex/logs
DX4	EDEX Ingest	/awips2/edex/logs
DX4	EDEX DAT Ingest	/awips2/edex/logs
DX4	EDEX GRIB Ingest	/awips2/edex/logs
DX4	EDEX Request	/awips2/edex/logs

Details on the EDEX process logs, including log file naming conventions, log entry formatting, and logging configuration, are covered in Section 25.6, EDEX Process Log and Log Format.

### **Example 25.4.1-1: Checking Status of EDEX Processes**

This recipe presents two scenarios: 1) checking the status of all EDEX processes; and 2) checking the status of a specific EDEX process. The steps to follow for each scenario are:

#### **Scenario 1: To Check the Status of the EDEX Processes on DX3**

```
$ ssh root@dx3
root@dx3's password:
$ cd /etc/init.d
$ ./edex_camel status

EDEX Camel (ingest) is running (wrapper PID 24173)
EDEX Camel (ingest) is running (java PID 24175)
EDEX Camel (ingestGrib) is running (wrapper PID 24272)
EDEX Camel (ingestGrib) is running (java PID 24274)
EDEX Camel (ingestDat) is running (wrapper PID 17309)
EDEX Camel (ingestDat) is running (java PID 17314)
EDEX Camel (request) is running (wrapper PID 24497)
EDEX Camel (request) is running (java PID 14130)
```

#### **Scenario 2: To Check the Status of the EDEX Request Process on DX3**

```
$ ssh root@dx3
root@dx3's password:
```



```
$ cd /etc/init.d
$ ./edex_camel status request

EDEX Camel (request) is running (wrapper PID 24497)
EDEX Camel (request) is running (java PID 14130)
```

### **Example 25.4.1-2: Starting EDEX Processes**

To start EDEX processes on DX4, use this recipe:

```
$ ssh root@dx4
root@dx4's password:
$ cd /etc/init.d
$ ./edex_camel start

Starting EDEX Camel (ingest): WARNING: EDEX ingest instance already
running, not starting another instance

OK

Starting EDEX Camel (ingestGrib): WARNING: EDEX ingestGrib instance
already running, not starting another instance

OK

Starting EDEX Camel (ingestDat): WARNING: EDEX ingestDat instance
already running, not starting another instance

OK

Starting EDEX Camel (request): WARNING: EDEX request instance
already running, not starting another instance

OK
```

*edex\_camel* does some checking prior to taking a start/stop action. Specifically, it checks for existing EDEX processes in each case. Then, for a start action:

1. It displays a warning if the process **is** already running, and
2. It displays a warning if the process **is not** already running.

In both cases, the action is terminated after the warning is issued.

### **Example 25.4.1-3: Starting EDEX Process (When Already Running)**

To attempt to start the EDEX ingest process on DX3 when it is already running, these are the steps to follow:

```
$ ssh root@dx3
root@dx3's password:
$ cd /etc/init.d
$ ./edex_camel start ingest

Starting EDEX Camel (ingest): WARNING: EDEX ingest instance already
running, not starting another instance
```

OK

Because of the *SEDA Load Balancing* provided by the QPID message broker, an EDEX process running on DX3 or DX4 may be stopped with minimal impact to overall system operation. The remaining EDEX process, on the other DX box, will automatically pick up the full load. Restarting the EDEX process will result in the load balance being restored.

One additional concept on system management is this: EDEX is a Java process that runs as a Java Virtual Machine (JVM). To improve the reliability/robustness of EDEX, AWIPS II uses *Java Service Wrapper* (wrapper) from Tanuki Software to manage the JVM running each EDEX process. Wrapper is an independent process that starts and monitors the EDEX JVM; should the JVM crash, wrapper will restart the EDEX process automatically. Both the crash and the restart are logged to the EDEX *process* log.

#### **Example 25.4.1-4: Using ps to Check for EDEX Processes**

The Linux *ps* tool is commonly used to obtain basic information on processes running on a Linux server. Because *ps* will provide a bunch on information, the Linux *grep* tool is normally used to filter its output. Use *ps* to obtain information on the EDEX ingest process on DX3. The steps to follow:

```
[root@dx3-tbw3 ~]# ps aux | grep ingest

awips    10293  0.0  0.0 106068  1256 ?        S   Apr28   0:00
/bin/bash /awips2/edex/bin/start.sh -noConsole ingestDat

awips    10294  0.0  0.0 106068  1288 ?        S   Apr28   0:00
/bin/bash /awips2/edex/bin/start.sh -noConsole ingest

awips    10295  0.0  0.0 106068  1260 ?        S   Apr28   0:00
/bin/bash /awips2/edex/bin/start.sh -noConsole ingestGrib

awips    10677 42.8  6.4 14985616 2121080 ?      SNsl Apr28 2548:36
/awips2/java/bin/java -Dedex.run.mode=ingestGrib -
Daw.site.identificier=BOX -Dedex.home=/awips2/edex -
XX:MaxPermSize=128m -Dorg.apache.camel.jmx.disabled=true -
Duser.timezone=GMT -Djava.io.tmpdir=/awips2/tmp -
XX:+UseConcMarkSweepGC -XX:+CMSIncrementalMode -
XX:+HeapDumpOnOutOfMemoryError -XX:HeapDumpPath=/data/fxa/cave/dx3-
tbw3/ -XX:SoftRefLRUPolicyMSPerMB=1000 -Dqpidd.dest_syntax=BURL -
Ddb.addr=dx1f -Ddb.port=5432 -Ddc.db.name=dc_ob7box -
Dfxa.db.name=fxatext -Dhm.db.name=hmdb -Dih.db.name=hd_ob92box -
Ddb.metadata.pool.max=10 -Ddb.metadata.pool.timeout=300 -
Ddata.archive.root=/data_store -
Dlogback.configurationFile=logback.xml -
Dlogback.statusListenerClass=com.raytheon.uf.common.logback.UFLogbac
kInternalStatusListener -
Dcom.mchange.v2.log.MLog=com.mchange.v2.log.FallbackMLog -
Dcom.mchange.v2.log.FallbackMLog.DEFAULT_CUTOFF_LEVEL=OFF -
Djava.util.logging.config.file=/awips2/edex/conf/logging.properties
-Dthrift.stream.maxsize=200 -
Djava.util.prefs.userRoot=/home/awips/.java/dx3-tbw3-
ingestGrib.userPrefs -
```

```

Djava.library.path=/awips2/edex/lib/native/linux32/awips1:/awips2/java/lib:/awips2/python/lib:/awips2/python/lib/python2.7/site-packages/jep:/awips2/psql/lib:/awips/ops/sharedLib:/awips2/yajsw/lib/core/jna/com/sun/jna/linux-
amd64:/awips2/python/lib:/awips2/postgresql/lib:/awips2/psql/lib:/awips2/qpidd/lib:/awips2/notification/lib:/awips2/tools/lib:/awips/ops/sharedlib:/awips2/edex/lib/native/linux32:/awips2/edex/lib/native/linux64/ -Xms128m -Xmx1536m -DMAX_PERM_SIZE=128m -DHM_DB_NAME=hmdb -DDEX_HOME=/awips2/edex -DPROFILER_PARAM_1= -DINIT_MEM=128 -DSHORT_HOSTNAME=dx3-tbw3 -DDATA_ARCHIVE_ROOT=/data_store -DIH_DB_NAME=hd_ob92box -DDB_ADDR=dx1f -DHOSTNAME=dx3-tbw3 -DLD_LIBRARY_PATH=/awips2/edex/lib/native/linux32/awips1:/awips2/java/lib:/awips2/python/lib:/awips2/python/lib/python2.7/site-packages/jep:/awips2/psql/lib:/awips/ops/sharedLib:/awips2/yajsw/lib/core/jna/com/sun/jna/linux-
amd64:/awips2/python/lib:/awips2/postgresql/lib:/awips2/psql/lib:/awips2/qpidd/lib:/awips2/notification/lib:/awips2/tools/lib:/awips/ops/sharedlib -DFXA_DB_NAME=fxatext -DDC_DB_NAME=dc_ob7box -DMETADATA_POOL_TIMEOUT=300 -DLOG_CONF=logback.xml -DMETADATA_POOL_MAX=10 -DHOME=/home/awips -DSOFT_REF_LRU_POLICY_MS_PER_MB=1000 -DAWIPS2_TEMP=/awips2/tmp -DDB_PORT=5432 -DWRAPPER_ON_EXIT_ACTION=RESTART -DCONSOLE_LOGLEVEL=NONE -classpath
/awips2/yajsw/wrapperApp.jar:/awips2/edex/conf:/awips2/edex/conf/cache:/awips2/edex/conf/spring:/awips2/edex/conf/resources:/awips2/edex/lib/dependencies/org.dom4j/*:/awips2/edex/lib/dependencies/org.jep/*:/awips2/edex/lib/dependencies/org.apache.velocity/*:/awips2/edex/lib/dependencies/gov.nasa.gsfc.fits/*:/awips2/edex/lib/dependencies/org.apache.activemq/*:/awips2/edex/lib/dependencies/org.apache.commons.cli/*:/awips2/edex/lib/dependencies/org.apache.commons.digester/*:/awips2/edex/lib/dependencies/org.apache.commons.collections/*:/awips2/edex/lib/dependencies/org.apache.camel/*:/awips2/edex/lib/dependencies/org.apache.xmlbeans/*:/awips2/edex/lib/dependencies/javax.jms/*:/awips2/edex/lib/dependencies/javax.mail/*:/awips2/edex/lib/dependencies/org.apache.ws.commons.schema/*:/awips2/edex/lib/dependencies/org.postgres/*:/awips2/edex/lib/dependencies/net.sf.cglib/*:/awips2/edex/lib/dependencies/org.javassist/*:/awips2/edex/lib/dependencies/com.mchange/*:/awips2/edex/lib/dependencies/org.apache.commons.beantils/*:/awips2/edex/lib/dependencies/voiceware/*:/awips2/edex/lib/dependencies/org.apache.commons.configuration/*:/awips2/edex/lib/dependencies/javax.measure/*:/awips2/edex/lib/dependencies/javax.servlet/*:/awips2/edex/lib/dependencies/org.apache.qpidd/*:/awips2/edex/lib/dependencies/org.slf4j/*:/awips2/edex/lib/dependencies/org.apache.commons.pool/*:/awips2/edex/lib/dependencies/org.eclipse.jetty/*:/awips2/edex/lib/dependencies/org.apache.commons.management/*:/awips2/edex/lib/dependencies/org.apache.commons.codec/*:/awips2/edex/lib/dependencies/org.apache.thrift/*:/awips2/edex/lib/dependencies/org.apache.commons.lang/*:/awips2/edex/lib/dependencies/org.quartz/*:/aw

awips      10825 28.0 10.4 16781020 3414164 ?      SNs1 Apr28 1665:49
/awips2/java/bin/java -Dedex.run.mode=ingest -
Daw.site.identifier=BOX -Dedex.home=/awips2/edex -
XX:MaxPermSize=128m -Dorg.apache.camel.jmx.disabled=true -
Duser.timezone=GMT -Djava.io.tmpdir=/awips2/tmp -
XX:+UseConcMarkSweepGC -XX:+CMSIncrementalMode -
XX:+HeapDumpOnOutOfMemoryError -XX:HeapDumpPath=/data/fxa/cave/dx3-

```

```

tbw3/ -XX:SoftRefLRUPolicyMSPerMB=1000 -Dqpid.dest_syntax=BURL -
Ddb.addr=dx1f -Ddb.port=5432 -Ddc.db.name=dc_ob7box -
Dfxa.db.name=fxatext -Dhm.db.name=hmdb -Dih.db.name=hd_ob92box -
Ddb.metadata.pool.max=50 -Ddb.metadata.pool.timeout=300 -
Ddata.archive.root=/data_store -Dlogback.configurationFile=logback-
ingest.xml -
Dlogback.statusListenerClass=com.raytheon.uf.common.logback.UFLogbac
kInternalStatusListener -
Dcom.mchange.v2.log.MLog=com.mchange.v2.log.FallbackMLog -
Dcom.mchange.v2.log.FallbackMLog.DEFAULT_CUTOFF_LEVEL=OFF -
Djava.util.logging.config.file=/awips2/edex/conf/logging.properties
-Dthrift.stream.maxsize=200 -
Djava.util.prefs.userRoot=/home/awips/.java/dx3-tbw3-
ingest.userPrefs -
Djava.library.path=/awips2/edex/lib/native/linux32/awips1:/awips2/ja
va/lib:/awips2/python/lib:/awips2/python/lib/python2.7/site-
packages/jep:/awips2/psql/lib:/awips/ops/sharedLib:/awips2/yajsw/lib
/core/jna/com/sun/jna/linux-
amd64:/awips2/python/lib:/awips2/postgresql/lib:/awips2/psql/lib:/aw
ips2/qpid/lib:/awips2/notification/lib:/awips2/tools/lib:/awips/ops/
sharedlib:/awips2/edex/lib/native/linux32:/awips2/edex/lib/native/l
inux64/ -Xms512m -Xmx2560m -DMAX_PERM_SIZE=128m -DHM_DB_NAME=hmdb -
DMAX_MEM=2560 -DJAVA_HOME=/awips2/java -DAW_SITE_IDENTIFIER=BOX -
DSHORT_HOSTNAME=dx3-tbw3 -DDATA_ARCHIVE_ROOT=/data_store -
DIH_DB_NAME=hd_ob92box -DDB_ADDR=dx1f -DHOSTNAME=dx3-tbw3 -
DEDEX_HOME=/awips2/edex -DPROFILER_PARAM_1= -DINIT_MEM=512 -
DLL_LIBRARY_PATH=/awips2/edex/lib/native/linux32/awips1:/awips2/java
/lib:/awips2/python/lib:/awips2/python/lib/python2.7/site-
packages/jep:/awips2/psql/lib:/awips/ops/sharedLib:/awips2/yajsw/lib
/core/jna/com/sun/jna/linux-
amd64:/awips2/python/lib:/awips2/postgresql/lib:/awips2/psql/lib:/aw
ips2/qpid/lib:/awips2/notification/lib:/awips2/tools/lib:/awips/ops/
sharedlib -DFXA_DB_NAME=fxatext -DDC_DB_NAME=dc_ob7box -
DMETADATA_POOL_TIMEOUT=300 -DLOG_CONF=logback-ingest.xml -
DMETADATA_POOL_MAX=50 -DHOME=/home/awips -
DSOFT_REF_LRU_POLICY_MS_PER_MB=1000 -DAWIPS2_TEMP=/awips2/tmp -
DDB_PORT=5432 -DWRAPPER_ON_EXIT_ACTION=RESTART -
DCONSOLE_LOGLEVEL=NONE -classpath
/awips2/yajsw/wrapperApp.jar:/awips2/edex/conf:/awips2/edex/conf/cac
he:/awips2/edex/conf/spring:/awips2/edex/conf/resources:/awips2/edex
/lib/dependencies/org.dom4j/*:/awips2/edex/lib/dependencies/org.jep/
*/awips2/edex/lib/dependencies/org.apache.velocity/*:/awips2/edex/l
ib/dependencies/gov.nasa.gsfc.fits/*:/awips2/edex/lib/dependencies/o
rg.apache.activemq/*:/awips2/edex/lib/dependencies/org.apache.common
s.cli/*:/awips2/edex/lib/dependencies/org.apache.commons.digester/*:
/awips2/edex/lib/dependencies/org.apache.commons.collections/*:/awip
s2/edex/lib/dependencies/org.apache.camel/*:/awips2/edex/lib/depende
ncies/org.apache.xmlbeans/*:/awips2/edex/lib/dependencies/javax.jms/
*/awips2/edex/lib/dependencies/javax.mail/*:/awips2/edex/lib/depend
encies/org.apache.ws.commons.schema/*:/awips2/edex/lib/dependencies/
org.postgres/*:/awips2/edex/lib/dependencies/net.sf.cglib/*:/awips2/
edex/lib/dependencies/org.javassist/*:/awips2/edex/lib/dependencies/
com.mchange/*:/awips2/edex/lib/dependencies/org.apache.commons.beanu
tils/*:/awips2/edex/lib/dependencies/voiceware/*:/awips2/edex/lib/de
pendencies/org.apache.commons.configuration/*:/awips2/edex/lib/depend
encies/javax.measure/*:/awips2/edex/lib/dependencies/javax.servlet/
*/awips2/edex/lib/dependencies/org.apache.qpid/*:/awips2/edex/lib/d

```

```

dependencies/org.slf4j/*:/awips2/edex/lib/dependencies/org.apache.com
mons.pool/*:/awips2/edex/lib/dependencies/org.eclipse.jetty/*:/awips
2/edex/lib/dependencies/org.apache.commons.management/*:/awips2/edex
/lib/dependencies/org.apache.commons.codec/*:/awips2/edex/lib/depend
encies/org.apache.thrift/*:/awips2/edex/lib/dependencies/org.apache.
commons.lang/*:/awips2/edex/lib/dependencies/org.quartz

```

```

awips 10905 9.9 5.6 15074428 1867620 ? SNsl Apr28 590:16
/awips2/java/bin/java -Dedex.run.mode=ingestDat -
Daw.site.identifiier=BOX -Dedex.home=/awips2/edex -
XX:MaxPermSize=128m -Dorg.apache.camel.jmx.disabled=true -
Duser.timezone=GMT -Djava.io.tmpdir=/awips2/tmp -
XX:+UseConcMarkSweepGC -XX:+CMSIncrementalMode -
XX:+HeapDumpOnOutOfMemoryError -XX:HeapDumpPath=/data/fxa/cave/dx3-
tbw3/ -XX:SoftRefLRUPolicyMSPerMB=1000 -Dqpidd.dest_syntax=BURL -
Ddb.addr=dx1f -Ddb.port=5432 -Ddc.db.name=dc_ob7box -
Dfxa.db.name=fxatext -Dhm.db.name=hmdb -Dih.db.name=hd_ob92box -
Ddb.metadata.pool.max=25 -Ddb.metadata.pool.timeout=300 -
Ddata.archive.root=/data_store -
Dlogback.configurationFile=logback.xml -
Dlogback.statusListenerClass=com.raytheon.uf.common.logback.UFLogbac
kInternalStatusListener -
Dcom.mchange.v2.log.MLog=com.mchange.v2.log.FallbackMLog -
Dcom.mchange.v2.log.FallbackMLog.DEFAULT_CUTOFF_LEVEL=OFF -
Djava.util.logging.config.file=/awips2/edex/conf/logging.properties
-Dthrift.stream.maxsize=200 -
Djava.util.prefs.userRoot=/home/awips/.java/dx3-tbw3-
ingestDat.userPrefs -
Djava.library.path=/awips2/edex/lib/native/linux32/awips1:/awips2/ja
va/lib:/awips2/python/lib:/awips2/python/lib/python2.7/site-
packages/jep:/awips2/psql/lib:/awips/ops/sharedLib:/awips2/yajsw/lib
/core/jna/com/sun/jna/linux-
amd64:/awips2/python/lib:/awips2/postgresql/lib:/awips2/psql/lib:/aw
ips2/qpidd/lib:/awips2/notification/lib:/awips2/tools/lib:/awips/ops/
sharedlib:/awips2/edex/lib/native/linux32:/awips2/edex/lib/native/l
inux64/ -Xms512m -Xmx2560m -DMAX_PERM_SIZE=128m -DHM_DB_NAME=hmdb -
DMAX_MEM=2560 -DJAVA_HOME=/awips2/java -DAW_SITE_IDENTIFIER=BOX -
DSHORT_HOSTNAME=dx3-tbw3 -DDATA_ARCHIVE_ROOT=/data_store -
DIH_DB_NAME=hd_ob92box -DDB_ADDR=dx1f -DHOSTNAME=dx3-tbw3 -
DEDEX_HOME=/awips2/edex -DPROFILER_PARAM_1= -DINIT_MEM=512 -
DLL_LIBRARY_PATH=/awips2/edex/lib/native/linux32/awips1:/awips2/java
/lib:/awips2/python/lib:/awips2/python/lib/python2.7/site-
packages/jep:/awips2/psql/lib:/awips/ops/sharedLib:/awips2/yajsw/lib
/core/jna/com/sun/jna/linux-
amd64:/awips2/python/lib:/awips2/postgresql/lib:/awips2/psql/lib:/aw
ips2/qpidd/lib:/awips2/notification/lib:/awips2/tools/lib:/awips/ops/
sharedlib -DFXA_DB_NAME=fxatext -DDC_DB_NAME=dc_ob7box -
DMETADATA_POOL_TIMEOUT=300 -DLOG_CONF=logback.xml -
DMETADATA_POOL_MAX=25 -DHOME=/home/awips -
DSOFT_REF_LRU_POLICY_MS_PER_MB=1000 -DAWIPS2_TEMP=/awips2/tmp -
DDB_PORT=5432 -DWRAPPER_ON_EXIT_ACTION=RESTART -
DCONSOLE_LOGLEVEL=NONE -classpath
/awips2/yajsw/wrapperApp.jar:/awips2/edex/conf:/awips2/edex/conf/cac
he:/awips2/edex/conf/spring:/awips2/edex/conf/resources:/awips2/edex
/lib/dependencies/org.dom4j/*:/awips2/edex/lib/dependencies/org.jep/
*/awips2/edex/lib/dependencies/org.apache.velocity/*:/awips2/edex/l
ib/dependencies/gov.nasa.gsfc.fits/*:/awips2/edex/lib/dependencies/o

```

```
rg.apache.activemq/*:/awips2/edex/lib/dependencies/org.apache.common
s.cli/*:/awips2/edex/lib/dependencies/org.apache.commons.digester/*:
/awips2/edex/lib/dependencies/org.apache.commons.collections/*:/awip
s2/edex/lib/dependencies/org.apache.camel/*:/awips2/edex/lib/depende
ncies/org.apache.xmlbeans/*:/awips2/edex/lib/dependencies/javax.jms/
*/awips2/edex/lib/dependencies/javax.mail/*:/awips2/edex/lib/depend
encies/org.apache.ws.commons.schema/*:/awips2/edex/lib/dependencies/
org.postgres/*:/awips2/edex/lib/dependencies/net.sf.cglib/*:/awips2/
edex/lib/dependencies/org.javassist/*:/awips2/edex/lib/dependencies/
com.mchange/*:/awips2/edex/lib/dependencies/org.apache.commons.beanu
tils/*:/awips2/edex/lib/dependencies/voiceware/*:/awips2/edex/lib/de
pendencies/org.apache.commons.configuration/*:/awips2/edex/lib/dep
endencies/javax.measure/*:/awips2/edex/lib/dependencies/javax.servlet/
*/awips2/edex/lib/dependencies/org.apache.qpid/*:/awips2/edex/lib/d
ependencies/org.slf4j/*:/awips2/edex/lib/dependencies/org.apache.com
mons.pool/*:/awips2/edex/lib/dependencies/org.eclipse.jetty/*:/awips
2/edex/lib/dependencies/org.apache.commons.management/*:/awips2/edex
/lib/dependencies/org.apache.commons.codec/*:/awips2/edex/lib/depend
encies/org.apache.thrift/*:/awips2/edex/lib/dependencies/org.apache.
```

At this point, it is easy to see that further tuning of the *ps / grep* approach for monitoring an EDEX process is required. This requires more information about the EDEX system and is covered in more detail in section 25.7, [EDEX System Monitoring](#).

#### 25.4.2 Managing Software on CPSBN1/21/2

CPSBN1 and CPSBN2 function as a heartbeat cluster; failover is managed automatically or manually. Note that only a single high-availability package is currently used on this cluster. The package name is a2cp1apps. In failover mode, package execution shifts to the backup server. LDM runs only on the SBN CP server. The a2cp1apps package manages the cp1f floating server name. Note that floating names are available only when the high-availability packages are running; they cannot be used to start or stop the high-availability packages

The AWIPS II services used on CPSBN1/2 are listed in Table 25.4.2-1.

**Table 25.4.2-1. CPSBN1/2 Services**

System	AWIPS II Services
CPSBN1 and CPSBN2	LDM, Queue Processor Interface Daemon (Apache AMQP Message Broker) (QPID), Java, Python, rehost

The AWIPS II services on CPSBN1/2 are managed using the standard Linux *service* tool, which requires root access to run and is normally located */sbin*. They can also be managed by directly executing the System V scripts located in */etc/init.d*. In addition, LDM may be controlled directly using the *ldmadmin* tool. The root user must switch user to *ldm* prior to running *ldmadmin*, however.

The AWIPS II services may be started with the Linux *service* command; the basic command format is *service <name> start*. To start the AWIPS II services on either CPSBN1 or CPSBN2, log into the target server using the root account and password.

1. To start *ldmcp*:

**Enter:** `service ldmcp start`

2. To start qpidd:

**Enter:** `service qpidd start`

3. To start pulse:

**Enter:** `service pulse start`

The AWIPS II services may be stopped with the Linux `service` command; the basic command format is `service <name> stop`. To stop the AWIPS II services on either CPSBN1 or CPSBN2, log into the target server using the root account and password.

1. To stop ldmcp:

**Enter:** `service ldmcp stop`

2. To stop qpidd:

**Enter:** `service qpidd stop`

3. To stop pulse:

**Enter:** `service pulse stop`

The AWIPS II services may be status checked with the Linux `service` command; the basic command format is `service <name> status`. It is also useful to use the Linux `ps` command to operation.

The CP1/2 cluster is a heartbeat cluster, although the architecture is somewhat different from that of DX1/2. On the CP1/2 cluster, the LDM processes will normally run on both CPSBN1 and CPSBN2 and are not heartbeat managed. The heartbeat manages QPID and pulse (IPVS), which run on one of the servers. This server is accessed via the cp1f floater. You will log into the servers using the `root` login and password.

The software to check on the CP1/2 cluster consists of:

- The heartbeat service (CPSBN1 and CPSBN2)
- The LDM processes (CPSBN1 and CPSBN2)
- The QPID message broker (cp1f)
- The pulse (IPVS) service (cp1f)

Dataflow to check on the CP1/2 cluster:

- LDM data flow (on CPSBN1 and CPSBN2)

For verification, perform these steps:

- a. Open a terminal window on your workstation.
- b. Log into CPSBN1 using the `root` login.

**Enter:** `ssh root@cpsbn1`

- c. Verify the heartbeat service is running.

**Enter:** `service heartbeat status`

```
heartbeat OK [pid 28624 et al] is running on cpsbn1-tbdw [cpsbn1-tbdw]...
```

d. Verify LDM processes are running.

**Enter:** `ps -ef | grep ldmd | grep -v grep | cut -b -80`

```
ldm      30195      1  0 Jul10 ?          00:00:00 ldmd -I 0.0.0.0 -P 388
-M 256 -m
```

**Enter:** `ps -wef | egrep noaaportIngest`

```
root      10778   9421   0 15:19 pts/0    00:00:00 grep noaaportIngest
root      26080  26076   2 Jan28 ?          03:18:21 noaaportIngest -b
10000 -m 224.0.1.1 -n -u 3 -t mhs -r 1 -s NMC
root      26081  26076   0 Jan28 ?          00:07:34 noaaportIngest -b
10000 -m 224.0.1.2 -n -u 4 -t mhs -r 1 -s GOES
root      26082  26076   3 Jan28 ?          05:30:54 noaaportIngest -b
10000 -m 224.0.1.3 -n -u 5 -t mhs -r 1 -s NMC2
root      26083  26076   0 Jan28 ?          00:09:10 noaaportIngest -b
10000 -m 224.0.1.4 -n -u 6 -t mhs -r 1 -s NOAAPORT_OPT
root      26084  26076   0 Jan28 ?          00:00:02 noaaportIngest -b
10000 -m 224.0.1.5 -n -u 7 -t mhs -r 1 -s NMC3
root      26085  26076   0 Jan28 ?          00:00:02 noaaportIngest -b
10000 -m 224.0.1.6 -n -u 4 -t mhs -r 1 -s ADD
```

**Note:** Sites would normally see only the first 5 channels listed above. ADD channel will only exist at sites where Data Delivery is activated. As of now, that is limited to test beds and a few regions. Once Data Delivery is “activated and fully operational”, then all the sites would be able to see the 6th channel (ADD).

e. Verify LDM data flow.

**Enter:** `su - ldm`

**Enter:** `ldmadmin watch`

**NOTE:** Look for a continuous stream of “INFO:” messages; press <Ctrl-D> to terminate the watch.

```
Jan 16 15:18:47 pqutil INFO:      8404 20140116151846.755 NEXRAD3
52594656 SDUS53 KGLD 161449 /pN0SGLD
Jan 16 15:18:47 pqutil INFO:      686 20140116151846.755 NEXRAD3
52594657 SDUS86 KPDT 161445 /pDODPDT
Jan 16 15:18:47 pqutil INFO:      9056 20140116151846.760 NEXRAD3
52594658 SDUS26 KLOX 161445 /pN2QVTX !nids/
Jan 16 15:18:47 pqutil INFO:     14214 20140116151846.761 NEXRAD3
52594659 SDUS83 KSGF 161445 /pN2XSGF !nids/
Jan 16 15:18:47 pqutil INFO:     24485 20140116151846.763 NEXRAD3
```



```

52594660 SDUS84 KBMX 161449 /pN0XMX !nids/
Jan 16 15:18:47 pqutil INFO: 4657 20140116151846.764 NEXRAD3
52594661 SDUS73 KBIS 161451 /pN0ZMBX
Jan 16 15:18:47 pqutil INFO: 37890 20140116151846.770 NEXRAD3
52594662 SDUS51 KCLE 161451 /pTV0LVE !nids/
Jan 16 15:18:47 pqutil INFO: 7695 20140116151846.771 NEXRAD3
52594663 SDUS82 KMLB 161449 /pN1KMLB !nids/
Jan 16 15:18:47 pqutil INFO: 11125 20140116151846.772 NEXRAD3
52594664 SDUS82 KMLB 161449 /pN1HMLB !nids/
Jan 16 15:18:47 pqutil INFO: 7447 20140116151846.772 NEXRAD3
52594665 SDUS53 KMKX 161451 /pN0VMKX
Jan 16 15:18:47 pqutil INFO: 4491 20140116151846.773 NEXRAD3
52594666 SDUS86 KMFR 161449 /pN0MMAX
Jan 16 15:18:47 pqutil INFO: 11290 20140116151846.774 NEXRAD3
52594667 SDUS51 KAKQ 161446 /pDVLAKQ !nids/
Jan 16 15:18:47 pqutil INFO: 5759 20140116151846.774 NEXRAD3
52594668 SDUS71 KAKQ 161446 /pEETAKQ !nids/
Jan 16 15:18:47 pqutil INFO: 33827 20140116151846.781 NEXRAD3
52594669 SDUS82 KMLB 161449 /pN1CMLB !nids/
Jan 16 15:18:47 pqutil INFO: 2300 20140116151846.781 NEXRAD3
52594670 SDUS34 KHGX 161447 /pN1PHGX
Jan 16 15:18:47 pqutil INFO: 5589 20140116151846.781 NEXRAD3
52594671 SDUS59 PAFG 161442 /pDVLAPD !nids/
Jan 16 15:18:47 pqutil INFO: 239 20140116151846.781 NEXRAD3
52594672 SDUS86 KPDT 161445 /pDAAPDT !nids/
Jan 16 15:18:47 pqutil INFO: 8660 20140116151846.782 NEXRAD3
52594673 SDUS53 KGLD 161449 /pN0VGLD
Jan 16 15:18:47 pqutil INFO: 1470 20140116151846.782 NEXRAD3
52594674 SDUS36 KPDT 161445 /pPTAPDT
Jan 16 15:18:47 pqutil INFO: 6186 20140116151846.783 NEXRAD3
52594675 SDUS53 KBIS 161451 /pN0QMBX !nids/
Jan 16 15:18:47 pqutil INFO: 523 20140116151846.783 NEXRAD3
52594676 SDUS31 KAKQ 161446 /pNSTAKQ
Jan 16 15:18:47 pqutil INFO: 22878 20140116151846.790 NEXRAD3
52594677 SDUS54 KHGX 161447 /pDHRHGX !nids/
Jan 16 15:18:47 pqutil INFO: 23130 20140116151846.792 NEXRAD3
52594678 SDUS88 PAFG 161449 /pN1XAKC !nids/

```

**Enter:** `exit`

- f. Log off CPSBN1.

**Enter:** `exit`

- g. Log into CPSBN2 using the *root* login.

**Enter:** `ssh root@cpsbn2`

- h. Verify the heartbeat service is running.

**Enter:** `service heartbeat status`

```
heartbeat OK [pid 5029 et al] is running on cpsbn2-tbdw [cpsbn2-tbdw]...
```

- i. Verify the LDM processes are running.

**Enter:** `ps -ef | grep ldm | grep -v grep | cut -b -80`

```
ldm 10274      1  0 Mar17 ?  00:00:02 ldmd -I 165.92.24.51 -P 388 -M 2
ldm 10276 10274  0 Mar17 ?  01:28:26 pqact -e
ldm 10277 10274  0 Mar17 ?  00:12:28 edexBridge -vx1 /usr/local/ldm/1
```

**Enter:** `ps -wef | egrep noaaportIngest`

```
root      10778  9421  0 15:19 pts/0    00:00:00 grep noaaportIngest
root      26080 26076  2 Jan28 ?          03:18:21 noaaportIngest -b
10000 -m 224.0.1.1 -n -u 3 -t mhs -r 1 -s NMC
root      26081 26076  0 Jan28 ?          00:07:34 noaaportIngest -b
10000 -m 224.0.1.2 -n -u 4 -t mhs -r 1 -s GOES
root      26082 26076  3 Jan28 ?          05:30:54 noaaportIngest -b
10000 -m 224.0.1.3 -n -u 5 -t mhs -r 1 -s NMC2
root      26083 26076  0 Jan28 ?          00:09:10 noaaportIngest -b
10000 -m 224.0.1.4 -n -u 6 -t mhs -r 1 -s NOAAPORT_OPT
root      26084 26076  0 Jan28 ?          00:00:02 noaaportIngest -b
10000 -m 224.0.1.5 -n -u 7 -t mhs -r 1 -s NMC3
root      26085 26076  0 Jan28 ?          00:00:02 noaaportIngest -b
10000 -m 224.0.1.6 -n -u 4 -t mhs -r 1 -s ADD
```

- j. Verify LDM data flow.

**Enter:** `su - ldm`

**Enter:** `ldmadmin watch`

**Note:** Look for a continuous stream of “INFO:” messages; press <Ctrl-D> to terminate the watch.

```
4 15:32:54 pqutil INFO:      95704 20130724153254.025 NEXRAD3 3216336
SDUS54 KFWD 241532 /pTV0DFW !nids/
Jul 24 15:32:54 pqutil INFO:      15694 20130724153254.030 NEXRAD3
3216337 SDUS24 KFWD 241530 /pN3QFWS !nids/
Jul 24 15:32:54 pqutil INFO:      64062 20130724153254.048 NEXRAD3
3216338 SDUS53 KLOT 241531 /pTV0ORD !nids/
Jul 24 15:32:54 pqutil INFO:      32190 20130724153254.058 NEXRAD3
3216339 SDUS24 KFWD 241530 /pN3UFWS !nids/
Jul 24 15:32:54 pqutil INFO:        188 20130724153254.058 IDS|DDPLUS
3216340 SXTN50 KWAL 241532
Jul 24 15:32:54 pqutil INFO:        152 20130724153254.058 IDS|DDPLUS
3216341 SZNC41 RJTD 241532
Jul 24 15:32:54 pqutil INFO:        2682 20130724153254.059 NEXRAD3
3216342 SDUS83 KGRB 241524 /pDTAGRB !nids/
Jul 24 15:32:54 pqutil INFO:       25141 20130724153254.066 NEXRAD3
3216343 SDUS85 KGJT 241532 /pN0KGJX !nids/
```

```

Jul 24 15:32:55 pqutil INFO:      38297 20130724153254.214 NEXRAD3
3216344 SDUS84 KFWD 241530 /pDTAFWS !nids/
Jul 24 15:32:55 pqutil INFO:       345 20130724153254.214 NEXRAD3
3216345 SDUS83 KGRB 241524 /pDSDGRB !nids/
Jul 24 15:32:55 pqutil INFO:       729 20130724153254.214 NEXRAD3
3216346 SDUS83 KGRB 241524 /pDODGRB !nids/
Jul 24 15:32:55 pqutil INFO:      8731 20130724153254.217 NEXRAD3
3216347 SDUS81 KGYX 241531 /pN0KGYX !nids/
Jul 24 15:32:55 pqutil INFO:      44166 20130724153254.229 NEXRAD3
3216348 SDUS84 KEPZ 241526 /pN2CEPZ !nids/
Jul 24 15:32:55 pqutil INFO:      3846 20130724153254.231 NEXRAD3
3216349 SDUS84 KEPZ 241526 /pDPREPZ !nids/
Jul 24 15:32:55 pqutil INFO:      6059 20130724153254.232 NEXRAD3
3216350 SDUS84 KEPZ 241526 /pHHCEPZ !nids/
Jul 24 15:32:55 pqutil INFO:       149 20130724153254.232      HDS
3216351 NXUS66 KPDT 241532 /pGSMPDT
Jul 24 15:32:55 pqutil INFO:      9365 20130724153254.423      NGRID
460163 LRGB86 KWBT 241200
!grib2/ncp/GFS/#255/201307241200F006/RELH/0 - ZPBL
Jul 24 15:32:55 pqutil INFO:      6018 20130724153254.425      NGRID
460164 LHGB00 KWBT 241200
!grib2/ncp/GFS/#255/201307241200F006/HGHT/0 - LLTW
Jul 24 15:32:55 pqutil INFO:      1703 20130724153254.425      NGRID
460165 MAGC98 KWBT 241200
!grib2/ncp/GFS/#255/201307241200F004/DWPK/0 - NONE
Jul 24 15:32:55 pqutil INFO:      9560 20130724153254.428      NGRID
460166 LRGB98 KWBT 241200
!grib2/ncp/GFS/#255/201307241200F006/SPFH/0 - NONE
Jul 24 15:32:55 pqutil INFO:      5553 20130724153254.430      NGRID
460167 LEGA98 KWBT 241200
!grib2/ncp/GFS/#255/201307241200F006/P06M/0 - NONE
Jul 24 15:32:55 pqutil INFO:      1264 20130724153254.430      NGRID
460168 LHGB98 KWBT 241200
!grib2/ncp/GFS/#255/201307241200F006/HGHT/0 - NONE
Jul 24 15:32:55 pqutil INFO:      1665 20130724153254.431      NGRID
460169 LAGB98 KWBT 241200
!grib2/ncp/GFS/#255/201307241200F006/DWPK/0 - NONE

```

**Enter:** `exit`

k. Log off CPSBN2.

**Enter:** `exit`

l. Log into cp1f using the *root* account.

**Enter:** `ssh root@cp1f`

m. Verify QPID is running.

**Enter:** `service qpidd status`

```
qpidd (pid 29150) is running...
```

**Enter:** `ps -ef | grep qpidd | grep -v grep | cut -b -80`

```
awips 29150 1 16 Oct20 ? 09:04:15
/awips2/qpidd/sbin/qpidd -daemon
```

- n. Verify pulse (IPVS) is running.

**Enter:** `service pulse status`

```
pulse (pid 3906) is running..
```

**Enter:** `ps -ef | grep pulse | grep -v grep | cut -b -80`

```
root 3906 1 0 May24 ? 00:00:00 pulse
```

- o. Log off cp1f.

**Enter:** `exit`

- p. Error results: As a general rule, if one of the processes is not running, the *ps* command will not print anything. If the service commands return a “not running” message, heartbeat is not running and automated failover will fail. If the floater (*cp1f*) login fails, this means that the high-availability package controlling the software is not running.

### 25.4.3 Managing Software on DX1/2

DX1 and DX2 function as a heartbeat cluster; failover is managed automatically or manually. Note that both DX1 and DX2 normally run separate high-availability packages; a2dx1apps on DX1 and a2dx2apps on DX2. In failover mode, both packages shift to the same server. Access to DX1 and DX2 is via server name alias: dx1f points to the server running the a2dx1apps package; dx2f points to the server running the a2dx2apps package. The high-availability packages are also used to manage several shared mounts to the Direct Attached Storage (DAS) and Network Attached Storage (NAS (NAS1 and NAS2)). Note that the floating names are available only when the high-availability packages are running; they cannot be used to start or stop the high-availability packages. The AWIPS II services used on DX1/2 are listed in table 25.4.3-1. The NAS and DAS file system mounts are listed in Table 25.4.3-2.

**Table 25.4.3-1. AWISP II Services on DX1/2**

Service	Applications Controlled	Notes
edex_postgres	PostgreSQL DBMS	managed by a2dx1apps
edex_rcm	Radar Server	managed by a2dx1apps
httpd-pypies	PyPIES	managed by a2dx2apps

**Table 25.4.3-2. DX1/2 Mounts on the DAS and NAS**

Mount	Mount Point	Notes
das1:/aiihdf5	/awips2/edex/data/hdf5	managed by a2dx1apps
das1:/aiidb	/awips2/data	managed by a2dx1apps

nas2:/data_store	/data_store	managed by a2dx2apps
nas1:/aiidata/utility	/awips2/edex/data/utility	managed by a2dx1apps
nas1:/GFESuite2	/awips2/GFESuite	managed by a2dx1apps

In addition to the AWIPS II services listed in Table 25.4.3-1, several re-hosted AWIPS II services continue to operate on DX1/2; these services are managed by the appropriate high-availability package.

In addition to using the heartbeat utilities for controlling the AWIPS II services, they may be managed individually. The `edex_postgres`, `edex_rpm`, and `httpd-pypies` are controlled using the Linux `service` command

The DX1/2 cluster is a heartbeat cluster with both nodes normally running AWIPS II processes. The two cluster nodes are accessible via the virtual server names **dx1f** and **dx2f**. You will be able to log into the appropriate node using the floating name **dx1f** or **dx2f**, and the `root` account and password.

The software to check on the DX1/2 cluster consists of:

- The heartbeat service (DX1 and DX2)
- The PostgreSQL database server (on dx1f)
- The Radar Server (on dx1f)
- The PyPIES data server (on dx2f)

Dataflow to check on the DX1/2 cluster:

- Radar Server data flow (on dx1f)

For verification, perform these steps:

- Open a terminal window on your workstation.
- Log into dx1f using the `root` login.

**Enter:** `ssh root@dx1f`

- Verify that the heartbeat service is running.

**Enter:** `service heartbeat status`

```
heartbeat OK [pid 1515 et al] is running on dx1-tbdw [dx1-tbdw]...
```

- Verify that the PostgreSQL server is running.

**Enter:** `ps -ef | grep postmaster | grep -v grep | cut -b -80`

```
awips      8003      1  0 Oct20 ?          00:00:25
/awips2/postgresql/bin/postmaste
```

- Verify that the Radar Server (RCM) is running.

**Enter:** `ps -ef | egrep "[/]rcm/" | tr -s ' ' | cut -b -80`

```

INFO 00:01:23,752 [TCM Read kbox #2] RadarServer: Stored message in
/data_store/radar/kbox/Z/elev2_4/res1/level16/kbox.19.20140526_2358
INFO 00:01:23,761 [TCM Read kbox #2] RadarServer: kbox: message
code=27 size=18820 elev=2.4 sequence=622 vs=2014-05-26 23:58:03 #80
INFO 00:01:23,761 [TCM Read kbox #2] RadarServer: Sending kbox
code=27 header=SDUS63 KOAX 262358 / N2VBOX (matched prodList)
INFO 00:01:23,761 [Thread-10] RadarServer: Running
[/awips/ops/bin/msg_send, -c, 0, -p, 1, -e,
/tmp/rcm2689793575575884052.tmp, -a, DEFAULTNCF]
INFO 00:01:23,776 [TCM Read kbox #2] RadarServer: Stored message in
/data_store/radar/kbox/V/elev2_4/res1/level16/kbox.27.20140526_2358
INFO 00:01:23,782 [TCM Read kbox #2] RadarServer: kbox: message
code=56 size=18126 elev=2.4 sequence=626 vs=2014-05-26 23:58:03 #80

```

f. Verify Radar Server data flow.

**Enter:** `tail -f /awips2/rcm/data/logs/radarserver.log`

**Note:** The current log is named *radarserver.log*; previous logs have the date of log appended.

**Note:** Look for messages containing “Stored message in”; press <Ctrl-C> to terminate tail.

```

INFO 00:00:01,125 [TCM Read keax #2] RadarServer: Stored
message in
/data_store/radar/keax/CC/elev5_3/res0_25/level256/keax.161.201
40601_2356

INFO 00:00:01,341 [TCM Read keax #2] RadarServer: keax:
message code=163 size=5918 elev=5.1 sequence=2817 vs=2014-06-01
23:56:42 #79

INFO 00:00:01,354 [TCM Read keax #2] RadarServer: Stored
message in
/data_store/radar/keax/KDP/elev5_3/res0_25/level256/keax.163.20
140601_2356

INFO 00:00:01,648 [TCM Read keax #2] RadarServer: keax:
message code=165 size=6241 elev=5.1 sequence=2822 vs=2014-06-01
23:56:42 #79

INFO 00:00:01,658 [TCM Read keax #2] RadarServer: Stored
message in
/data_store/radar/keax/HC/elev5_3/res0_25/level256/keax.165.201
40601_2356

INFO 00:00:02,023 [TCM Read keax #2] RadarServer: keax:
message code=149 size=1543 elev=5.1 sequence=2801 vs=2014-06-01
23:56:42 #79

INFO 00:00:02,027 [TCM Read keax #2] RadarServer: Stored
message in
/data_store/radar/keax/DMD/elev5_3/keax.149.20140601_2356

INFO 00:00:09,360 [TCM Read keax #2] RadarServer: keax:
message code=166 size=5960 elev=6.4 sequence=2828 vs=2014-06-01

```

```
23:56:42 #79

INFO 00:00:09,363 [TCM Read keax #2] RadarServer: Stored
message in
/data_store/radar/keax/ML/elev6_0/keax.166.20140601_2356

INFO 00:00:10,363 [TCM Read keax #2] RadarServer: keax:
message code=94 size=6142 elev=6.4 sequence=2791 vs=2014-06-01
23:56:42 #79
```

g. Log off dx1f.

**Enter:** `exit`

h. Log into dx2f using the *root* login.

**Enter:** `ssh root@dx2f`

i. Verify the heartbeat service is running.

**Enter:** `service heartbeat status`

```
heartbeat OK [pid 1515 et al] is running on dx2-tbdw [dx2-tbdw]...
```

j. Verify that the PyPIES data server is running.

**Enter:** `ps -ef | grep httpd_pypies | grep -v grep | cut -b -80`

awips	2875	8149	2	Oct22	?	00:00:35	
/awips2/httpd_pypies/usr/sbin/ht							
awips	5952	8149	5	00:15	?	00:00:09	
/awips2/httpd_pypies/usr/sbin/ht							
awips	6159	8149	3	00:15	?	00:00:05	
/awips2/httpd_pypies/usr/sbin/ht							
awips	6842	8149	2	Oct22	?	00:00:46	
/awips2/httpd_pypies/usr/sbin/ht							
root	8149		1	0	Oct20	?	00:00:00
/awips2/httpd_pypies/usr/sbin/ht							
awips	8823	8149	2	Oct22	?	00:00:31	
/awips2/httpd_pypies/usr/sbin/ht							
awips	8846	8149	2	Oct22	?	00:00:41	
/awips2/httpd_pypies/usr/sbin/ht							
awips	8847	8149	2	Oct22	?	00:00:29	
/awips2/httpd_pypies/usr/sbin/ht							
awips	11479	8149	2	Oct22	?	00:00:32	
/awips2/httpd_pypies/usr/sbin/ht							
awips	11496	8149	3	Oct22	?	00:00:45	
/awips2/httpd_pypies/usr/sbin/ht							
awips	11497	8149	2	Oct22	?	00:00:29	
/awips2/httpd_pypies/usr/sbin/ht							
awips	11529	8149	3	Oct22	?	00:00:40	
/awips2/httpd_pypies/usr/sbin/ht							
awips	11530	8149	2	Oct22	?	00:00:33	
/awips2/httpd_pypies/usr/sbin/ht							
awips	11531	8149	2	Oct22	?	00:00:37	
/awips2/httpd_pypies/usr/sbin/ht							
awips	11532	8149	2	Oct22	?	00:00:27	
/awips2/httpd_pypies/usr/sbin/ht							
awips	12843	8149	2	Oct22	?	00:01:02	
/awips2/httpd_pypies/usr/sbin/ht							
awips	19247	8149	2	Oct22	?	00:00:54	
/awips2/httpd_pypies/usr/sbin/ht							
awips	19269	8149	1	Oct22	?	00:00:50	
/awips2/httpd_pypies/usr/sbin/ht							
awips	26434	8149	2	Oct22	?	00:00:45	
/awips2/httpd_pypies/usr/sbin/ht							
awips	28162	8149	2	Oct22	?	00:00:44	
/awips2/httpd_pypies/usr/sbin/ht							
awips	28507	8149	2	Oct22	?	00:00:48	
/awips2/httpd_pypies/usr/sbin/ht							
awips	31098	8149	2	Oct22	?	00:00:45	
/awips2/httpd_pypies/usr/sbin/ht							
awips	31328	8149	2	Oct22	?	00:00:49	
/awips2/httpd_pypies/usr/sbin/ht							

k. Log off dx2f.

**Enter:** `exit`

1. Error Results: As a general rule, if any of the *ps* commands has an empty return, the specific process being checked is not running. If the service commands return a “not running” message, heartbeat is not running and automated failover will fail. If either login fails, this means the high-availability package controlling the software is not running.



#### 25.4.4 *Managing Software on PX1/2*

PX1 and PX2 are used to run various re-hosted applications. As in AWIPS I, the PX1/2 cluster is a heartbeat cluster. The main operational change is the names of the high-availability packages. For AWIPS II they are a2px1apps and a2px2apps.

The AWIPS II high-availability packages on PX1 are controlled using the heartbeat utilities: hb\_run, hb\_halt, and hb\_stat. In normal operation, only the a2px1apps high-availability package is running on PX1.

1. To start a2px1apps:  
**Enter: hb\_run a2px1apps**
2. To stop a2px1apps:  
**Enter: hb\_halt a2px1apps**
3. To verify a2px1apps:  
**Enter: hb\_stat**

The AWIPS II high-availability packages on PX2 are controlled using the heartbeat utilities: hb\_run, hb\_halt, and hb\_stat. In normal operation, only the a2px2apps high-availability package is running on PX2.

1. To start a2px2apps:  
**Enter: hb\_run a2px2apps**
2. To stop a2px2apps:  
**Enter: hb\_halt a2px2apps**
3. To verify a2px2apps:  
**Enter: hb stat**

Logging by the re-hosted apps on PX1/2 is generally unchanged. Specifically, log locations are unchanged for the re-hosted applications.

#### 25.4.5 *Managing Software on DX3/4*

DX3 and DX4 are independent servers, both of which run the EDEX server software. **There is no failover between DX3 and DX4.** Both servers are load balanced and share data processing responsibilities; if one server is stopped, the other will pick up the entire data processing load. Processing load balancing between DX3 and DX4 is provided by QPID as data messages are removed from QPID queues and processed by the EDEX instance having available processing capacity. Client request balancing for DX3 and DX4 is managed by Internet Protocol Virtual Server (IPVS) (the pulse service). Both QPID and IPVS run on CPSBN1 and CPSBN2.

Unlike the other servers, the AWIPS II software must be verified on both DX3 and DX4. Access to both servers is by direct login. The steps in this procedure must be performed on both DX3 and DX4 using the *root* login and password.

The software to check on DX3 and DX4 consists of:

- EDEX server software.

Dataflow to check on the DX3/4:

- EDEX ingest processes (on DX3 and DX4).

For verification, perform these steps:

- Open a terminal window on your workstation.
- Log into DX3 using the *root* login.

**Enter:** `ssh root@dx3`

- Determine the available memory on the server.

**Enter:** `free -g`

	total	used	free	shared	buffers	cached	
Mem:		7	6	0	0	0	1
-/+ buffers/cache:			5	2			
Swap:		2	0	2			

- Verify the EDEX server software is running.

**Note:** There are four possible instances of EDEX: *ingest*, *request*, *ingestGrib*, and *ingestDat*. If the available memory indicated by the *free -g* command is less than 4 GB, *ingestDat* will not be running.

**Enter:** `service edex_camel status`

```
EDEX Camel (ingest) is running (wrapper PID 27792)
EDEX Camel (ingest) is running (java PID 27794)
EDEX Camel (ingestGrib) is running (wrapper PID 27896)
EDEX Camel (ingestGrib) is running (java PID 27898)
EDEX Camel (ingestDat) is running (wrapper PID 28001)
EDEX Camel (ingestDat) is running (java PID 28003)
EDEX Camel (request) is running (wrapper PID 28119)
EDEX Camel (request) is running (java PID 28121)
```

**Enter:** `ps -ef | grep edex.run.mode | grep -v grep | cut -b -80`

```
awips 837 834 12 Apr19 ? 08:35:40 /awips2/java/bin/java -Dedex.run
awips 17456 17451 7 Apr19 ? 05:13:35 /awips2/java/bin/java -Dedex.run
awips 25828 25826 78 Apr20 ? 1-16:54:51 /awips2/java/bin/java -Dedex.r
awips 31216 30171 5 Apr20 ? 02:37:31 /awips2/java/bin/java -Dedex.run
```

- Verify EDEX ingest process data flow.

**Enter:** `cd /awips2/edex/logs`

**Enter:** `tail -f edex-ingest-`date +%Y%m%d`.log`

**Note:** Look for a continuous display of messages containing “processed in:”; press **<Ctrl-C>** to terminate tail.

```
INFO 2015-06-01 00:29:49,505 [external.dropbox-2] JmsPooledProducer:
EDEX - Creating AMQ producer Ingest.bufrmos
INFO 2015-06-01 00:29:49,919 [Ingest.bufrmos-1] Ingest: EDEX: Ingest
- bufrmos::
/data_store/bufrmos/20150601/00/JSMF15_KWNO_010000_3435472.bufr.201506
0100 processed in: 1.4090 (sec) Latency: 1.4180 (sec)
INFO 2015-06-01 00:29:50,506 [external.dropbox-3] JmsPooledProducer:
EDEX - Creating AMQ producer Ingest.bufrmos
Time spent in persist: 130
INFO 2015-06-01 00:29:51,509 [external.dropbox-1] JmsPooledProducer:
EDEX - Creating AMQ producer Ingest.bufrmos
INFO 2015-06-01 00:29:52,022 [Ingest.bufrmos-1] Ingest: EDEX: Ingest
- bufrmos::
/data_store/bufrmos/20150601/00/JSMF12_KWNO_010000_3435476.bufr.201506
0100 processed in: 1.5120 (sec) Latency: 1.5200 (sec)
Time spent in persist: 141
INFO 2015-06-01 00:29:54,406 [Ingest.bufrmos-1] Ingest: EDEX: Ingest
- bufrmos::
/data_store/bufrmos/20150601/00/JSMF14_KWNO_010000_3435477.bufr.201506
0100 processed in: 2.3350 (sec) Latency: 2.9040 (sec)
INFO 2015-06-01 00:49:12,287 [Ingest.bufrsigwx-1] SigWxDataAdapter:
/res/pointdata/cat_swhshm.xmlPointDataDescription loaded
INFO 2015-06-01 00:49:12,288 [Ingest.bufrsigwx-1] SigWxDecoder: null
- Decoded 5 obs
Time spent in persist: 16
INFO 2015-06-01 00:49:12,309 [Ingest.bufrsigwx-1] Ingest: EDEX:
Ingest - bufrsigwx::
/data_store/bufrsigwx/20150531/18/JUME00_KKCI_311800_3443997.bufr.2015
060100 processed in: 0.0260 (sec) Latency: 0.0350 (sec)
INFO 2015-06-01 00:49:18,280 [external.dropbox-3] JmsPooledProducer:
EDEX - Creating AMQ producer Ingest.bufrsigwx
INFO 2015-06-01 00:49:18,289 [Ingest.bufrsigwx-1] SigWxDataAdapter:
/res/pointdata/trop_swhshm.xmlPointDataDescription loaded
INFO 2015-06-01 00:49:18,289 [Ingest.bufrsigwx-1] SigWxDecoder: null
- Decoded 3 obs
Time spent in persist: 15
INFO 2015-06-01 00:49:18,307 [Ingest.bufrsigwx-1] Ingest: EDEX:
Ingest - bufrsigwx::
/data_store/bufrsigwx/20150531/18/JUOE00_KKCI_311800_3444040.bufr.2015
060100 processed in: 0.0230 (sec) Latency: 0.0310 (sec)
```

**Enter:** `tail -f edex-ingestGrib-`date +%Y%m%d`.log`

**Note:** Look for a continuous display of messages containing “processed in:”; press **<Ctrl-C>** to terminate tail.

```
INFO 2015-06-01 00:06:34,619 [Ingest.GribSplit-2] JmsPooledProducer:
```

```

EDEX - Creating AMQ producer Ingest.GribDecode
INFO 2015-06-01 00:06:34,885 [Ingest.GribSplit-1] JmsPooledProducer:
EDEX - Creating AMQ producer Ingest.GribDecode
INFO 2015-06-01 00:06:34,909 [Ingest.GribDecode-2] Ingest: EDEX:
Ingest - grib1::
/awips2/edex/data/processing/ZETA98_BDHRMOSAIC201506010001z_01000625.gr
ib processed in: 0.0340 (sec) Latency: 0.0490 (sec)
INFO 2015-06-01 00:06:34,917 [Ingest.GribDecode-4] Ingest: EDEX:
Ingest - grib1::
/awips2/edex/data/processing/ZETA98_ERMOSAICM60201506010001z_01000626.g
rib processed in: 0.0330 (sec) Latency: 0.0490 (sec)
INFO 2015-06-01 00:06:34,932 [Ingest.GribDecode-1] Ingest: EDEX:
Ingest - grib1::
/awips2/edex/data/processing/ZETA98_EBMOSAICM60201506010001z_01000626.g
rib processed in: 0.0420 (sec) Latency: 0.0560 (sec)
INFO 2015-06-01 00:06:35,460 [Camel (persist-camel) thread #4 -
timer://notificationTimer] JmsPooledConnection: EDEX - Creating
connection: com.raytheon.uf.common.jms.JmsPooledConnection@5a9203ae
INFO 2015-06-01 00:06:35,464 [IoReceiver - cplf/165.92.24.60:5672]
ClientDelegate: Heartbeat interval is 0 sec. Heartbeats are disabled.
INFO 2015-06-01 00:25:15,126 [Ingest.GribDecode-2] Ingest: EDEX:
Ingest - grib1::
/data_store/manual/grib/20150501/23/mpe/ZETA98_2015053123z_01002505.gri
b processed in: 0.0200 (sec) Latency: 0.0340 (sec)
INFO 2015-06-01 00:25:15,137 [Ingest.GribDecode-4] Ingest: EDEX:
Ingest - grib1::
/data_store/manual/grib/20150601/00/mpe/ZETA98_2015060100z_01002507.gri
b processed in: 0.0090 (sec) Latency: 0.0220 (sec)
INFO 2015-06-01 00:25:15,459 [Camel (persist-camel) thread #4 -
timer://notificationTimer] JmsPooledConnection: EDEX - Creating
connection: com.raytheon.uf.common.jms.JmsPooledConnection@50689bd
INFO 2015-06-01 00:25:15,464 [IoReceiver - cplf/165.92.24.60:5672]
ClientDelegate: Heartbeat interval is 0 sec. Heartbeats are disabled.
INFO 2015-06-01 00:25:15,465 [Camel (persist-camel) thread #4 -
timer://notificationTimer] AMQConnection: Connection 269 now connected
from /165.92.24.3:34522 to cplf/165.92.24.60:5672

```

f. Log off DX3.

**Enter:** `exit`

g. Log into DX4 using the *root* login.

**Enter:** `ssh root@dx4`

h. Determine the available memory on the server.

**Enter:** `free -g`

total	used	free	shared	buffers	cached	
Mem:	7	7	0	0	0	2
-/+ buffers/cache:	4		3			
Swap:	2	0	1			

- i. Verify the EDEX server software is running.

**Note:** There are four possible instances of EDEX: ingest, request, ingestGrib, and ingestDat. If the available memory indicated by the *free -g* command is less than 4 GB, ingestDat will not be running.

**Enter:** `service edex_camel status`

```
EDEX Camel (ingest) is running (java PID 23995)
EDEX Camel (ingestGrib) is running (wrapper PID 24110)
EDEX Camel (ingestGrib) is running (java PID 24112)
EDEX Camel (ingestDat) is running (wrapper PID 24213)
EDEX Camel (ingestDat) is running (java PID 24215)
EDEX Camel (request) is running (wrapper PID 24333)
EDEX Camel (request) is running (java PID 24336)
```

**Enter:** `ps -ef | grep edex.run.mode | grep -v grep | cut -b -80`

```
awips 23995 23992 99 Oct21 ? 1-08:00:31
/awips2/java/bin/java -Dedex.r
awips 24112 24110 9 Oct21 ? 03:07:58 /awips2/java/bin/java
-Dedex.run
awips 24215 24213 2 Oct21 ? 00:41:29 /awips2/java/bin/java
-Dedex.run
awips 24336 24333 1 Oct21 ? 00:32:08 /awips2/java/bin/java
-Dedex.run
```

- j. Verify EDEX ingest process data flow.

**Enter:** `cd /awips2/edex/logs`

**Enter:** `tail -f edex-ingest-`date +%Y%m%d`.log`

**Note:** Look for a continuous display of messages containing “processed in:”; press **<Ctrl-C>** to terminate tail.

```
WARN 2015-06-01 14:04:16,063 [Ingest.binlightning-1]
EncryptedBinLightningCipher: EDEX -
/data_store/entlightning/20150601/10/SFPA42_KWBC_011038_1441837.201506
0114 - Data length from file
/data_store/entlightning/20150601/10/SFPA42_KWBC_011038_1441837.201506
0114 is 17556 bytes, trailing 4 bytes has been trimmed to 17552 bytes
for decryption.
INFO 2015-06-01 14:04:16,063 [Ingest.binlightning-1]
EncryptedBinLightningCipher: EDEX - Data (17552 bytes) decrypted to
17552 bytes with key: 2014-06-06-newkey
WARN 2015-06-01 14:04:16,064 [Ingest.binlightning-1]
TotalLightningDecoder: EDEX - Extra data at end of lightning packets:
10 bytes
```

```

INFO 2015-06-01 14:04:16,096 [Ingest.binlightning-1] Ingest: EDEX:
Ingest - binlightning::
/data_store/entlightning/20150601/10/SFPA42_KWBC_011038_1441837.201506
0114 processed in: 0.0350 (sec) Latency: 0.1240 (sec)
INFO 2015-06-01 14:04:16,100 [Ingest.goessounding-1] Ingest: EDEX:
Ingest - goessounding::
/data_store/goessounding/20150601/13/JUTX05_KNES_011306_11300206.bufr.
2015060114 processed in: 0.0080 (sec) Latency: 0.1830 (sec)
INFO 2015-06-01 14:04:16,118 [Ingest.goessounding-1] Ingest: EDEX:
Ingest - goessounding::
/data_store/goessounding/20150601/13/JUTX05_KNES_011306_11300208.bufr.
2015060114 processed in: 0.0070 (sec) Latency: 0.2000 (sec)
INFO 2015-06-01 14:04:16,129 [Ingest.goessounding-1] Ingest: EDEX:
Ingest - goessounding::
/data_store/goessounding/20150601/13/JUTX05_KNES_011306_11300211.bufr.
2015060114 processed in: 0.0080 (sec) Latency: 0.2120 (sec)
INFO 2015-06-01 14:04:16,133 [Ingest.airep-1] Ingest: EDEX: Ingest -
airep::
/data_store/airep/20150601/13/UANT01_CWAO_011307_11300157.2015060114
processed in: 0.2470 (sec) Latency: 0.2950 (sec)
INFO 2015-06-01 14:04:16,150 [Ingest.goessounding-1] Ingest: EDEX:
Ingest - goessounding::
/data_store/goessounding/20150601/13/JUTX05_KNES_011306_11300213.bufr.
2015060114 processed in: 0.0140 (sec) Latency: 0.2320 (sec)

```

**Enter:** `tail -f edex-ingestGrib-`date +%Y%m%d`.log`

**Note:** Look for a continuous display of messages containing “processed in.”; press **<Ctrl-C>** to terminate tail.

```

INFO 2016-04-30 00:00:00,206 [GribPersist-3] Ingest: EDEX: Ingest -
grib2:: /data_store/grib2/20160429/23/HRRR/GRID255/2300Z_F004_TMPK-
YTCE50_KWBY_292300_78292851.grib2.2016042923 processed in: 0.2460
(sec) Latency: 0.2670 (sec)
INFO 2016-04-30 00:00:00,206 [GribPersist-3] GridPersister: EDEX -
Processed: [1/976.5kB/37ms] to /HRRR/MB/grid-2016-04-29-23.h5, in
process on other threads: [2/1.9MB], pending: [0/0.0B]
INFO 2016-04-30 00:00:00,232 [GribPersist-6] Ingest: EDEX: Ingest -
grib2:: /data_store/grib2/20160429/23/HRRR/GRID255/2300Z_F004_TMPK-
YTCE85_KWBY_292300_78292850.grib2.2016042923 processed in: 0.2720
(sec) Latency: 0.2930 (sec)
INFO 2016-04-30 00:00:00,232 [GribPersist-6] GridPersister: EDEX -
Processed: [1/976.5kB/63ms] to /HRRR/MB/grid-2016-04-29-23.h5, in
process on other threads: [1/976.5kB], pending: [0/0.0B]
INFO 2016-04-30 00:00:00,266 [GribPersist-4] Ingest: EDEX: Ingest -
grib2:: /data_store/grib2/20160429/23/HRRR/GRID255/2300Z_F004_VREL-
YVCE50_KWBY_292300_78292852.grib2.2016042923 processed in: 0.2940
(sec) Latency: 0.3270 (sec)
INFO 2016-04-30 00:00:00,266 [GribPersist-4] GridPersister: EDEX -
Processed: [1/976.5kB/90ms] to /HRRR/MB/grid-2016-04-29-23.h5, in
process on other threads: [0/0.0B], pending: [0/0.0B]

```

```
INFO 2016-04-30 00:00:00,954 [Ingest.GribDecode-2] GribDecoder: EDEX
- Decoding file:
/data_store/grib2/20160429/23/HRRR/GRID255/2300Z_F004_UREL-
YUCE92_KWBY_292300_78292853.grib2.2016043000
```

k. Log off DX4.

**Enter:** `exit`

l. Error results: If the EDEX software is not running, the `ps` command will display nothing. If fewer than three lines of output are produced, one or more EDEX processes are not running.

**NOTE:** The `free -g` command in step c. can be refined to limit the output. Entering `free -g | grep Mem | tr -s [:space:] | cut -d ' ' -f 2` will display a single number identifying the memory size in gigabytes.

## 25.5 System Configuration

Most system configuration is handled at system installation.

## 25.6 EDEX Process Log and Log Format

The EDEX processes generate a number of log files as they execute. This section offers an overview of these logs and information on the primary process log. More Recipes on monitoring the process logs are included in Section 25.7, [EDEX System Monitoring](#).

### 25.6.1 Process Logs

EDEX process logs are located in the `/awips2/edex/logs` directory. This directory will contain several logs; one log is created for each EDEX process, each day. EDEX is normally configured to retain up to 30 log files for each EDEX process.

### 25.6.2 Additional Log Files

In addition to the EDEX process logs, the JVM occasionally generates an error log in the JVM's run directory. For the EDEX processes, the run directory is `/awips2/edex/bin`.

This log is created when 1) the JVM crashes, and 2) it is able to generate a log file before the crash. In the event of a JVM crash, this log could hold valuable information about the cause of the crash. Reports on EDEX crashes should include the information in this log.

The JVM error log files are named `hs_err_pidxxx.log`, where `xxx` is the PID of the JVM that generated the log.

### 25.6.3 Process Log File Naming Convention

The EDEX process logs are located in the `/awips2/edex/logs` directory. The logs are named `edex-{process}-{date}.log`.

- *{process}* identifies the EDEX process that creates the log. The EDEX processes, as discussed in section 25.2.2, Operational Considerations, are ingest, ingestGrib, and request.
- *{date}* is the date the log was created; the date format is YYYYMMDD.

### Example 25.6.3-1: Log File Names

The log created by the EDEX Ingest process on October 22, 2011, is named *edex-ingest-20111022.log*.

## 25.6.4 Log Formats

The EDEX processes use a console appender to capture all logging to a single log file; this includes both formatted log messages and unformatted output such as that produced by writing to Linux's STDOUT and STDERR. As a result, most entries in an EDEX process log follow a standard format, which, as specified in the log4j configuration, is

```
%-5p %d [%t] %c{1}: %m%n
```

The components of this format definition are:

1. **%-5p** – The “p” specifies that the logging level is to be output. The “%-5” specifies the formatting; it is to be left justified in a five-character field
2. **%d** – This component specifies that the date/time of the message is to be printed. The format used is YYYY-MM-DD hh:mm:ss,xxx where xxx is milliseconds.
3. **[%t]** – This component specifies that the thread generating the message is listed. For EDEX, this is generally the camel route's thread pool; it can usually be ignored for diagnostic purposes.
4. **%c{1}** – This component specifies that the logger handling the message is listed. The “{1}” specifies that only the final component of the logger name is listed. Usually, this is the name of the class that logs the message. The colon is printed immediately following the logger name.
5. **%m%n** – The “%m” specifies that the message from the application is logged; the “%n” specifies that it should be followed by a new-line character.

To summarize, the standard log format is

```
LEVEL DATE-TIME [THREAD] LOGGER: MESSAGE
```

If the log message contains multiple lines, as is the case when a Java stack trace is included, only the first line of the message follows this format. Of the standard elements in a log message, the logging level and the logger can be used with the Linux *tail* and *grep* tools to provide real-time filtering of log messages. In addition, there are some standard message patterns that can be useful in monitoring for specific information/problems in an EDEX instance.

## 25.6.5 EDEX Logging Levels



EDEX logs messages at one of these five severity levels: DEBUG; INFO; WARNING; ERROR; and FATAL. Each message logged by the application is given one of these levels. In addition, the logging facility is configured with a logging level. Only messages that meet or exceed the configured logging level are written to the log file. For example, if the logging facility is configured to a logging level of *WARNING*, only messages with a level of *WARNING* and above (i.e., *WARNING*, *ERROR*, and *FATAL*) are logged.

Out of the box, most EDEX logging is at the *INFO* level; in this case *INFO*, *WARNING*, *ERROR*, and *FATAL* messages are logged.

### **Example 25.6.5-1: Monitoring EDEX Process Log for Errors**

To monitor for errors in the EDEX Ingest process on DX4, use *tail* to display the EDEX log. To filter for errors, pipe the results of *tail* to *grep*, using the appropriate filter on *grep*. (**Note:** For this example, assume the current date is September 10, 2014). The steps to follow:

```
$ ssh awips@dx4
awips@dx4's password:
$ cd /awips2/edex/logs
$ tail -f edex-ingest-20140910.log | grep -P "^ERROR"
```

```
ERROR 2014-09-10 00:27:05,859 [Ingest.binlightning-1]
EncryptedBinLightningCipher: Fail to decrypt with all known keys,
either data is not encrypted or is invalid: Given final block not
properly padded
INFO 2014-09-10 00:27:05,859 [Ingest.binlightning-1]
BinLightningDecoderUtil:
/data_store/binlightning/20140910/00/SFUS41_KWBC_100025_179163588.nldn.
2014091000 - Given final block not properly padded: Decryption failed,
will try decode the old-fashioned way
ERROR 2014-09-10 00:29:24,592 [Ingest.dpa-1] ProcessBuilder: ksh
/awips2/edex/data/share/hydroapps/precip_proc/bin/Run_DecodeDPA
/awips2/edex/data/share/hydroapps/precip_proc/local/data/dpa_gather/KSG
F_DPA_100027-SDUS53_KSGF_179169132.rad.2014091000 failed with exit code
1
ERROR 2014-09-10 00:29:24,592 [Ingest.dpa-1] DecodeDpaSrv: DPA Product
not decoded. DpaDecoder process terminated with exit code: 1
```

### **25.6.6 Controlling Logging Levels**

This section will be updated as information becomes available.

### **25.7 EDEX System Monitoring**

This section discusses a few of the options available for monitoring the EDEX processes. The EDEX processes are deployed on DX3 and DX4 (see [Exhibit 25.2-1](#)).

System monitoring is somewhat complicated by the general design and deployment of EDEX, as described earlier. Factors to be considered include the following:

1. Each EDEX process is designed around the Service Oriented Architecture (SOA) concept and is, therefore, a collection of services that perform specific tasks or functions in response to events. In the ingest stream discussed in section 25.3, Basic Data Flow Concepts, the event that triggers an action in a Data Decoder service is the arrival of a message in that decoder's message queue. Other events include time-based (Quartz triggered) events and client requests (http/thrift events). A good way to visualize SOA events is to picture your favorite GUI application. As you manipulate the GUI, events are created that cause the application to perform processing for you. EDEX utilizes the SOA concept to provide somewhat similar, event-driven processing.
2. Because each EDEX process logs primarily to a single log file,<sup>1</sup> some filtering is needed to extract information specific to a service from the combined log file of the EDEX process.
3. EDEX services replace many of the separate processes running on the AWIPS I servers. As noted previously, the result is that messages from all *services* in each EDEX *process* are combined in a single log file.

### 25.7.1 Using Standard Linux Tools

Table 25.7.1-1 lists several standard Linux tools that can be used to monitor the EDEX processes. Other useful monitoring tools include the Java Jconsole tool, which is packaged with EDEX. The PG Admin tool and HDF View, which are not packaged with EDEX, may be used to check the database and the data store.

**Table 25.7.1-1. Useful Tools for Monitoring EDEX**

Tool	Location	Monitoring Use
ps	/bin	Can be used to get information about specific processes
cat	/bin	Used to display a text file in a terminal
tail	/usr/bin	Used to provide a dynamic picture of process logs
grep	/bin	Used to filter content of process logs; used to filter output of other tools
top	/usr/bin	Provides a dynamic view of the memory and cpu usage of the EDEX processes
tee	/usr/bin	Sends command line output to a file
less	/usr/bin	Used to give a page-oriented view of files; includes search capabilities
edex_camel	/etc/init.d	Determines the PIDs of the EDEX processes
JConsole	/awips2/java/bin	Monitors the internal state of an EDEX process

The rest of this section is a series of Examples that illustrate various monitoring activities for EDEX processes. All of these examples make the following simple assumptions:

1. EDEX is installed on DX3. For other servers, the initial login should be modified as appropriate.
2. EDEX is installed under /awips2. Supporting software such as Java and Python is also installed under /awips2.

<sup>1</sup> The basic logging should stay the same, although some of the messages being logged may change.

3. The administrator is logging into the server using ssh from a Linux workstation.

### **Example 25.7.1-1: Determining the EDEX Version**

The installed EDEX version is listed in a file named *banner.txt*, which is located in */awips2/edex/conf*. The steps to follow:

```
$ ssh awips@dx3
awips@dx3's password:
$ cd /awips2/edex/conf
$ cat banner.txt
*****
* AWIPS II EDEX ESB Platform *
* Version: 16.1.1-30 *
* Raytheon Company *
* ----- *
* Build Date : 12-11-2015 *
* Build Time : 14:48:50 EST *
* Build System: build64 *
*****
```

**Note:** Version and build information displayed will be different depending on the installed version of EDEX.

### **Example 25.7.1-2: Determining EDEX Status**

The status of the EDEX processes may be determined using the *status* option of the *edex\_camel* script. This option is also helpful for determining the PID of each EDEX process. Unlike other options involving *edex\_camel*, the *status* option is usable by only **root** user account on the server. The steps to follow:

```
$ ssh root@dx3
root@dx3's password:
$ cd /etc/init.d
$ ./edex_camel status
EDEX Camel (ingest) is running (wrapper PID 24173)
EDEX Camel (ingest) is running (java PID 24175)
EDEX Camel (ingestGrib) is running (wrapper PID 24272)
EDEX Camel (ingestGrib) is running (java PID 24274)
EDEX Camel (ingestDat) is running (wrapper PID 17309)
EDEX Camel (ingestDat) is running (java PID 17314)
EDEX Camel (request) is running (wrapper PID 24497)
EDEX Camel (request) is running (java PID 14130)
```

This output indicates that three EDEX processes are running. Note that the reported PIDs will depend on the actual PIDs on the server being monitored.

**TIP:** To determine the status of a specific EDEX process, specify the process name

on the command line. For example: `./edex_camel status request.`

**TIP:** If one of the EDEX processes is not running, the status reported will be “EDEX Camel (*process*) is not running” where *process* is the name of the process that is not running. (See section 25.2.2, [Operational Considerations](#) for a list of EDEX processes.)

### Example 25.7.1-3: Determining EDEX Process Restarts

Each time wrapper starts a JVM running an EDEX process, it prints *Launching a JVM...* in the process log. This provides an easy means of determining the number of times an EDEX process has been started. The steps to follow:

```
$ ssh awips@dx3
awips@dx3's password:
$ cd /awips2/edex/logs
$ ls edex*-20111023.log

edex-ingest-20111023.log
edex-ingestDat-20111023.log
edex-ingest-gen_areal_ffg-20111023.log
edex-ingest-gen_areal_qpe-20111023.log
edex-ingestGrib-20111023.log
edex-ingest-purge-20111023.log
edex-ingest-radar-20111023.log
edex-ingest-satellite-20111023.log
edex-ingest-shef-20111023.log
edex-ingest-shef-performance-20111023.log
edex-ingest-smartInit-20111023.log
edex-ingest-text-20111023.log
edex-ingest-unrecognized-files-20111023.log
edex-request-20111023.log
edex-request-productSrvRequest-20111023.log
edex-ingest-archive-20111023.log
edex-ingest-activeTableChange-20111023.log
edex-ingestDat-performance-20111023.log
edex-ingestGrib-performance-20111023.log
edex-ingest-performance-20111023.log
edex-request-performance-20111023.log
edex-ingest-gen_areal_qpe-20111023.log
start-edex-ingest-20111023.log
start-edex-ingestDat-20111023.log
start-edex-ingestGrib-20111023.log
start-edex-request-20111023.log
edex-request-hibernate-20111023.log
edex-ingest-hibernate-20111023.log
edex-ingest-ohd-20111023.log
edex-request-textdbSrvRequest-20111023.log
edex-ingestDat-performance-20111023.log
edex-request-sportlma-20111023.log
edex-ingestGrib-hibernate-20111023.log
```

```
$ grep "Launching" edex-ingest-20111023.log
edex-ingest-20111023.log:Launching a JVM...
edex-ingest-20111023.log:Launching a JVM...
```

This output shows that the EDEX *ingest* process was started twice on Oct 23, 2011. In this case the EDEX installation was also performed on Oct 23, so we know *wrapper* restarted the *ingest* process once – this indicates a process crash that should be investigated.

**TIP:** To determine the starts logged in each process log, use the *-c* (count) option on *grep*.

**NOTE:** The names of the available log files depend on when EDEX was first started and the length of time the EDEX processes have actually been running on the server.

#### **Example 25.7.1-4: Determining Available Data Types from Ingest**

This Example shows how to monitor ingest of a specific data type on one of the EDEX servers. This Example obtains a list of data types being ingested. The list can then be used to selectively monitor ingest of a specific data type. The steps to follow:

```
$ ssh awips@dx3
awips@dx3's password:
$ cd /awips2/edex/logs
```

**Note:** For today's log file, for example use `ls edex-*-20111023.log`

```
edex-ingest-20111023.log
edex-ingestDat-20111023.log
edex-ingest-gen_areal_ffg-20111023.log
edex-ingest-gen_areal_qpe-20111023.log
edex-ingestGrib-20111023.log
edex-ingest-purge-20111023.log
edex-ingest-radar-20111023.log
edex-ingest-satellite-20111023.log
edex-ingest-shef-20111023.log
edex-ingest-shef-performance-20111023.log
edex-ingest-smartInit-20111023.log
edex-ingest-text-20111023.log
edex-ingest-unrecognized-files-20111023.log
edex-request-20111023.log
edex-request-productSrvRequest-20111023.log
edex-ingest-archive-20111023.log
edex-ingest-activeTableChange-20111023.log
edex-ingestDat-performance-20111023.log
edex-ingestGrib-performance-20111023.log
edex-ingest-performance-20111023.log
edex-request-performance-20111023.log
edex-ingest-gen_areal_qpe-20111023.log
start-edex-ingest-20111023.log
start-edex-ingestDat-20111023.log
start-edex-ingestGrib-20111023.log
```

```

start-edex-request-20111023.log
edex-request-hibernate-20111023.log
edex-ingest-hibernate-20111023.log
edex-ingest-ohd-20111023.log
edex-request-textdbSrvRequest-20111023.log
edex-ingestDat-performance-20111023.log
edex-request-sportlma-20111023.log
edex-ingestGrib-hibernate-20111023.log

```

```

$ grep -Po "Ingest: .+::" edex-ingest-20111023.log > ingest-
types.txt

```

```

Ingest: EDEX: Ingest - obs::
Ingest: EDEX: Ingest - sfcobs::
Ingest: EDEX: Ingest - obs::
Ingest: EDEX: Ingest - sfcobs::
Ingest: EDEX: Ingest - sfcobs::
Ingest: EDEX: Ingest - sfcobs::
Ingest: EDEX: Ingest - warning::
Ingest: EDEX: Ingest - ldadhydro::
Ingest: EDEX: Ingest - ldadmsonet::
Ingest: EDEX: Ingest - obs::
Ingest: EDEX: Ingest - acars::
Ingest: EDEX: Ingest - bufrhdw::
Ingest: EDEX: Ingest - bufrhdw::
Ingest: EDEX: Ingest - bufrhdw::
Ingest: EDEX: Ingest - bufrhdw::
Ingest: EDEX: Ingest - bufrhdw::
Ingest: EDEX: Ingest - bufrhdw::
Ingest: EDEX: Ingest - obs::
Ingest: EDEX: Ingest - bufrhdw::
Ingest: EDEX: Ingest - bufrhdw::
Ingest: EDEX: Ingest - bufrhdw::
Ingest: EDEX: Ingest - bufrhdw::
"ingest-types.txt" 135778L, 4742279C
Ingest: EDEX: Ingest - obs::
Ingest: EDEX: Ingest - sfcobs::
Ingest: EDEX: Ingest - obs::
Ingest: EDEX: Ingest - sfcobs::
Ingest: EDEX: Ingest - sfcobs::
Ingest: EDEX: Ingest - sfcobs::
Ingest: EDEX: Ingest - warning::
Ingest: EDEX: Ingest - ldadhydro::
Ingest: EDEX: Ingest - ldadmsonet::
Ingest: EDEX: Ingest - obs::
Ingest: EDEX: Ingest - acars::
Ingest: EDEX: Ingest - bufrhdw::
Ingest: EDEX: Ingest - bufrhdw::
Ingest: EDEX: Ingest - bufrhdw::
Ingest: EDEX: Ingest - bufrhdw::
Ingest: EDEX: Ingest - bufrhdw::
Ingest: EDEX: Ingest - bufrhdw::
Ingest: EDEX: Ingest - obs::
Ingest: EDEX: Ingest - bufrhdw::

```

```

Ingest: EDEX: Ingest - bufrhdw::
Ingest: EDEX: Ingest - bufrhdw::
Ingest: EDEX: Ingest - bufrhdw::
Ingest: EDEX: Ingest - bufrhdw::
Ingest: EDEX: Ingest - bufrhdw::
Ingest: EDEX: Ingest - bufrhdw::
Ingest: EDEX: Ingest - obs::
Ingest: EDEX: Ingest - obs::
Ingest: EDEX: Ingest - obs::
Ingest: EDEX: Ingest - redbook::
Ingest: EDEX: Ingest - obs::
Ingest: EDEX: Ingest - obs::
Ingest: EDEX: Ingest - acars::
Ingest: EDEX: Ingest - bufrhdw::
Ingest: EDEX: Ingest - obs::
Ingest: EDEX: Ingest - sfcobs::
Ingest: EDEX: Ingest - bufrhdw::
Ingest: EDEX: Ingest - obs::
Ingest: EDEX: Ingest - binlightning::
Ingest: EDEX: Ingest - acars::
Ingest: EDEX: Ingest - bufrhdw::
Ingest: EDEX: Ingest - bufrhdw::
Ingest: EDEX: Ingest - bufrhdw::
Ingest: EDEX: Ingest - obs::
Ingest: EDEX: Ingest - obs::
Ingest: EDEX: Ingest - obs::
Ingest: EDEX: Ingest - obs::
Ingest: EDEX: Ingest - obs::
Ingest: EDEX: Ingest - obs::
Ingest: EDEX: Ingest - obs::
Ingest: EDEX: Ingest - acars::
Ingest: EDEX: Ingest - bufrhdw::
Ingest: EDEX: Ingest - bufrhdw::
Ingest: EDEX: Ingest - bufrhdw::
Ingest: EDEX: Ingest - bufrhdw::
Ingest: EDEX: Ingest - bufrhdw::
Ingest: EDEX: Ingest - bufrhdw::
Ingest: EDEX: Ingest - bufrhdw::
Ingest: EDEX: Ingest - bufrhdw::
Ingest: EDEX: Ingest - bufrhdw::
Ingest: EDEX: Ingest - bufrhdw::
Ingest: EDEX: Ingest - bufrhdw::
Ingest: EDEX: Ingest - bufrhdw::
Ingest: EDEX: Ingest - obs::
Ingest: EDEX: Ingest - obs::
Ingest: EDEX: Ingest - qc::
Ingest: EDEX: Ingest - acars::
Ingest: EDEX: Ingest - obs::
Ingest: EDEX: Ingest - obs::
Ingest: EDEX: Ingest - obs::
Ingest: EDEX: Ingest - obs::
Ingest: EDEX: Ingest - obs::
Ingest: EDEX: Ingest - obs::
Ingest: EDEX: Ingest - obs::
Ingest: EDEX: Ingest - obs::

```





```

Ingest: EDEX: Ingest - obs::
Ingest: EDEX: Ingest - obs::
Ingest: EDEX: Ingest - warning::
Ingest: EDEX: Ingest - obs::
Ingest: EDEX: Ingest - obs::
Ingest: EDEX: Ingest - sfcobs::
Ingest: EDEX: Ingest - obs::
Ingest: EDEX: Ingest - obs::
Ingest: EDEX: Ingest - sfcobs::
Ingest: EDEX: Ingest - obs::
Ingest: EDEX: Ingest - sfcobs::
Ingest: EDEX: Ingest - sfcobs::
Ingest: EDEX: Ingest - sfcobs::
Ingest: EDEX: Ingest - warning::
Ingest: EDEX: Ingest - ldadhydro::
Ingest: EDEX: Ingest - ldadmsonet::
Ingest: EDEX: Ingest - obs::
Ingest: EDEX: Ingest - acars::
Ingest: EDEX: Ingest - bufrhdw::
Ingest: EDEX: Ingest - bufrhdw::
Ingest: EDEX: Ingest - bufrhdw::
Ingest: EDEX: Ingest - bufrhdw::
Ingest: EDEX: Ingest - bufrhdw::
Ingest: EDEX: Ingest - bufrhdw::
Ingest: EDEX: Ingest - bufrhdw::
Ingest: EDEX: Ingest - obs::
Ingest: EDEX: Ingest - bufrhdw::
Ingest: EDEX: Ingest - bufrhdw::
Ingest: EDEX: Ingest - bufrhdw::
Ingest: EDEX: Ingest - bufrhdw::
Ingest: EDEX: Ingest - bufrhdw::
Ingest: EDEX: Ingest - obs::
Ingest: EDEX: Ingest - obs::
Ingest: EDEX: Ingest - obs::
Ingest: EDEX: Ingest - redbook::
Ingest: EDEX: Ingest - obs::
Ingest: EDEX: Ingest - obs::
Ingest: EDEX: Ingest - acars::
Ingest: EDEX: Ingest - bufrhdw::
Ingest: EDEX: Ingest - obs::
Ingest: EDEX: Ingest - sfcobs::

```

This output shows a sorted list of data types being processed on this server.

**TIP:** The `-P` option on `grep` allows you to use a *Perl 5* regular expression as your search pattern. The `-o` option limits the output to *only* the portion of the line that matches the pattern.

**TIP:** This recipe uses the `sort` and `uniq` tools to help identify/filter information. See the man pages for details.

**Example 25.7.1-5: Monitoring Data Ingest**

Each time a data file is successfully ingested, the EDEX Ingest process logs a message. The general format of the message is *INFO <date> <time> [thread] Ingest: type:: <message>*. (Note that there are two spaces between INFO and the start of the date stamp.) The strategy is to tail the active log file and use `grep` to limit the output to show successful data ingest messages. This recipe presents two scenarios for monitoring data ingest: 1) monitoring all data ingest; and 2) monitoring ingest of a specific type of data.

**Scenario 1: Monitoring General Data Ingest**

For general data ingest, we can ignore the *type* token and simply look for INFO messages from ingest. (A Perl 5 regex that matches is `^INFO.+ Ingest: .`) The steps to follow:

```
$ ssh awips@dx3
awips@dx3's password:
$ cd /awips2/edex/logs

$ ls edex-*-20111023.log

edex-ingest-20111023.log
edex-ingestDat-20111023.log
edex-ingest-gen_areal_ffg-20111023.log
edex-ingest-gen_areal_qpe-20111023.log
edex-ingestGrib-20111023.log
edex-ingest-purge-20111023.log
edex-ingest-radar-20111023.log
edex-ingest-satellite-20111023.log
edex-ingest-shef-20111023.log
edex-ingest-shef-performance-20111023.log
edex-ingest-smartInit-20111023.log
edex-ingest-text-20111023.log
edex-ingest-unrecognized-files-20111023.log
edex-request-20111023.log
edex-request-productSrvRequest-20111023.log
edex-ingest-archive-20111023.log
edex-ingest-activeTableChange-20111023.log
edex-ingestDat-performance-20111023.log
edex-ingestGrib-performance-20111023.log
edex-ingest-performance-20111023.log
edex-request-performance-20111023.log
edex-ingest-gen_areal_qpe-20111023.log
start-edex-ingest-20111023.log
start-edex-ingestDat-20111023.log
start-edex-ingestGrib-20111023.log
start-edex-request-20111023.log
edex-request-hibernate-20111023.log
edex-ingest-hibernate-20111023.log
edex-ingest-ohd-20111023.log
edex-request-textdbSrvRequest-20111023.log
edex-ingestDat-performance-20111023.log
edex-request-sportlma-20111023.log
edex-ingestGrib-hibernate-20111023.log
```

```
$ tail -f edex-ingest-<YYYYMMDD.log> | grep -P "^INFO .+ Ingest:"

INFO 2014-09-10 01:25:29,001 [Ingest.obs-1] Ingest: EDEX: Ingest -
obs::
/data_store/metar/20140910/01/SAOS32_LOWM_100120_179296970.201409100
1 processed in: 0.0010 (sec) Latency: 0.0620 (sec)
Time spent in persist: 42
INFO 2014-09-10 01:29:25,134 [Ingest.bufrmos-1] Ingest: EDEX:
Ingest - bufrmos::
/data_store/bufrmos/20140910/01/JSMF14_KWNO_100100_32470556.bufr.201
4091001 processed in: 3.6400 (sec) Latency: 4.8970 (sec)
To stop monitoring, press <ctrl-c>.
```

### Scenario 2: Monitoring Specific Data Ingest

To monitor a specific data ingest, it is necessary to include the *type* token in the grep. (A Perl 5 regex that matches is `^INFO .+ Ingest: type::`. Replace *type* with the name of the data type to monitor.) For this example, we will monitor radar ingest. The steps to follow:

```
$ ssh awips@dx3
awips@dx3's password:
$ cd /awips2/edex/logs

$ ls edex-*-20130213.log

edex-ingest-20111023.log
edex-ingestDat-20111023.log
edex-ingest-gen_areal_ffg-20111023.log
edex-ingest-gen_areal_qpe-20111023.log
edex-ingestGrib-20111023.log
edex-ingest-purge-20111023.log
edex-ingest-radar-20111023.log
edex-ingest-satellite-20111023.log
edex-ingest-shef-20111023.log
edex-ingest-shef-performance-20111023.log
edex-ingest-smartInit-20111023.log
edex-ingest-text-20111023.log
edex-ingest-unrecognized-files-20111023.log
edex-request-20111023.log
edex-request-productSrvRequest-20111023.log
edex-ingest-archive-20111023.log
edex-ingest-activeTableChange-20111023.log
edex-ingestDat-performance-20111023.log
edex-ingestGrib-performance-20111023.log
edex-ingest-performance-20111023.log
edex-request-performance-20111023.log
edex-ingest-gen_areal_qpe-20111023.log
start-edex-ingest-20111023.log
start-edex-ingestDat-20111023.log
start-edex-ingestGrib-20111023.log
start-edex-request-20111023.log
edex-request-hibernate-20111023.log
edex-ingest-hibernate-20111023.log
edex-ingest-ohd-20111023.log
```

```
edex-request-textdbSrvRequest-20111023.log
edex-ingestDat-performance-20111023.log
edex-ingestGrib-hibernate-20111023.log
```

```
$ tail -f edex-ingest-<<YYYYMMDD.log>> | grep -P "^INFO .+ Ingest:
pirep::"
```

```
INFO 2014-09-10 00:00:11,374 [Ingest.pirep-1] Ingest: EDEX: Ingest
- pirep::
/data_store/pirep/20140910/00/UBWV90_KWBC_100000_179097505.201409100
0 processed in: 0.1320 (sec) Latency: 0.2680 (sec)
```

To stop monitoring, press <ctrl-c>.

**NOTE:** In both scenarios, the Linux *cut* utility can be used to limit the displayed output. For example, to eliminate the date stamp from the output, pipe the tail/grep command from either scenario into *cut -d ' ' -f 1,4,6-15*. (This also eliminates the *[thread]* from the output but includes the data type and file name.)

### Example 25.7.1-6: Monitoring Data Ingest Latency

Latency is the elapsed time between when the AWIPS II system first contacts a data file and when the data has been ingested, decoded, and is ready for retrieval by either CAVE or another client application. This information is logged into the EDEX process logs for every file that is ingested. The general format of the message is *INFO <date> <time> [thread] Ingest: <type>:: <file> processed in: <time> Latency: <time>*. (Note that there are two spaces between INFO and the start of the date stamp.) This pattern can be used to monitor the EDEX Ingest process logs for ingest latency, using the pattern to filter out undesirable messages.

This recipe presents two scenarios: 1) general latency monitoring; and 2) monitoring latency for a specific data type. Both scenarios use the Linux *tail* and *grep* tools to provide real-time display of the log files while filtering to eliminate extra output. They also use the Linux *cut* tool to eliminate some extra information from the lines being displayed.

#### Scenario 1: Monitoring General Data Latency

For general data latency, we can ignore the *type* token and simply capture the *INFO* messages from Ingest. To simplify the output, we will use *cut* to eliminate the date and time stamps, the thread identifier, the data type, and the file name from the output.

The Perl 5 regex: `^INFO .+ Ingest:`

The cut command: `cut -d ' ' -f 1,4,6,9-`

The steps to follow:

```
$ ssh awips@dx3
awips@dx3's password:
$ cd /awips2/edex/logs
```

```
$ ls edex-*-20111023.log

edex-ingest-20111023.log
edex-ingestDat-20111023.log
edex-ingest-gen_areal_ffg-20111023.log
edex-ingest-gen_areal_qpe-20111023.log
edex-ingestGrib-20111023.log
edex-ingest-purge-20111023.log
edex-ingest-radar-20111023.log
edex-ingest-satellite-20111023.log
edex-ingest-shef-20111023.log
edex-ingest-shef-performance-20111023.log
edex-ingest-smartInit-20111023.log
edex-ingest-text-20111023.log
edex-ingest-unrecognized-files-20111023.log
edex-request-20111023.log
edex-request-productSrvRequest-20111023.log
edex-ingest-archive-20111023.log
edex-ingest-activeTableChange-20111023.log
edex-ingestDat-performance-20111023.log
edex-ingestGrib-performance-20111023.log
edex-ingest-performance-20111023.log
edex-request-performance-20111023.log
edex-ingest-gen_areal_qpe-20111023.log
start-edex-ingest-20111023.log
start-edex-ingestDat-20111023.log
start-edex-ingestGrib-20111023.log
start-edex-request-20111023.log
edex-request-hibernate-20111023.log
edex-ingest-hibernate-20111023.log
edex-ingest-ohd-20111023.log
edex-request-textdbSrvRequest-20111023.log
edex-ingestDat-performance-20111023.log
edex-ingestGrib-hibernate-20111023.log
```

```
$ tail -f edex-ingest-20111023.log | grep -P "^INFO .+ Ingest:" |
cut -d ' ' -f 1,4,6,9-
  (as EDEX Ingest writes to the log file, lines identifying
  successful ingest with processing and latency times are displayed.)
```

To stop monitoring, press <ctrl-c>.

Typical messages will be similar to

<pre>INFO 18:41:56,011 Ingest: processed in: 0.0440 (sec) Latency: 0.0880 (sec) INFO 18:41:58,021 Ingest: processed in: 0.0830 (sec) Latency: 0.0870 (sec) INFO 18:41:58,061 Ingest: processed in: 0.0380 (sec) Latency: 0.1260 (sec)</pre>
---------------------------------------------------------------------------------------------------------------------------------------------------------------------------------------------------------------------------------------------

### ***Scenario 2: Monitoring Data Latency for a Specific Data Type***

To monitor a specific data type, the *type* is important. Other than that, the process is nearly identical to scenario 1. For this example, we will monitor radar data.

The Perl 5 regex: `^INFO .+ Ingest: radar::`

The cut command: `cut -d ' ' -f 1,4-6,9-15`

The steps to follow:

```
$ ssh awips@dx3
awips@dx3's password:
$ cd /awips2/edex/logs
$ ls edex-*.log
```

**Note:** For today's log file, for example, use `ls edex-*-20111023.log`

```
edex-ingest-20111023.log
edex-ingestDat-20111023.log
edex-ingest-gen_areal_ffg-20111023.log
edex-ingest-gen_areal_qpe-20111023.log
edex-ingestGrib-20111023.log
edex-ingest-purge-20111023.log
edex-ingest-radar-20111023.log
edex-ingest-satellite-20111023.log
edex-ingest-shef-20111023.log
edex-ingest-shef-performance-20111023.log
edex-ingest-smartInit-20111023.log
edex-ingest-text-20111023.log
edex-ingest-unrecognized-files-20111023.log
edex-request-20111023.log
edex-request-productSrvRequest-20111023.log
edex-ingest-archive-20111023.log
edex-ingest-activeTableChange-20111023.log
edex-ingestDat-performance-20111023.log
edex-ingestGrib-performance-20111023.log
edex-ingest-performance-20111023.log
edex-request-performance-20111023.log
edex-ingest-gen_areal_qpe-20111023.log
start-edex-ingest-20111023.log
start-edex-ingestDat-20111023.log
start-edex-ingestGrib-20111023.log
start-edex-request-20111023.log
edex-request-hibernate-20111023.log
edex-ingest-hibernate-20111023.log
edex-ingest-ohd-20111023.log
edex-request-textdbSrvRequest-20111023.log
edex-ingestDat-performance-20111023.log
edex-request-sportlma-20111023.log
edex-ingestGrib-hibernate-20111023.log

$ tail -f edex-ingest-radar-20111023.log | grep -P "^INFO .+ Ingest:
radar::" | cut -d ' ' -f 1,4,6,7,9-
```

To stop monitoring, press <ctrl-c>.

Typical messages will be similar to this:

```
INFO 2014-05-27 00:57:13,472 [Ingest.RadarRadarServer-1] Ingest:
EDEX: Ingest - radar-local::
/data_store/radar/kbox/TVS/kbox.61.20140526_0622 processed in:
0.2350 (sec) Latency: 66,516.2680 (sec)
```

```
INFO 2014-05-27 00:57:13,529 [Ingest.Radar-1] Ingest: EDEX: Ingest
- radar-sbn::
/data_store/radar/20140526/06/KOKX/NAQ/KOKX_NAQ_260626-
SDUS51_KOKX_64116811.rad.2014052606 processed in: 0.0620 (sec)
Latency: 66,571.9940 (sec)
```

**NOTE:** You can expect the latency time to vary somewhat during the day depending on the rate at which data is arriving at the particular time of day. Extended periods of high latency are an indication of general system problems.

**TIP:** To monitor other data types, change *radar* to the name of the data type. See [Example 25.7.1-4](#) to determine available data types.

### Example 25.7.1-7: Monitoring Ingest Failures

Unfortunately, as of this writing, there is no standard message logged when an ingest process fails. The closest available is a message with the general format of *ERROR* `<date> <time> [thread] Logger:< message>`. (A Perl 5 regex that matches this pattern is `^ERROR.+Logger:.`) This pattern has two problems. First, it does not name the file being ingested when the error occurred, and second, it is not exclusive to file ingest. Because all ingest is handled by the EDEX ingest or GRIB ingest process, the second problem is less of an issue. The steps to follow:

```
$ ssh awips@dx3
awips@dx3's password:
$ cd /awips2/edex/logs
$ ls edex-*-20111023.log
```

**Note:** For today's log file, for example use `ls edex-*-20111023.log`

```
edex-ingest-20111023.log
edex-ingestDat-20111023.log
edex-ingest-gen_areal_ffg-20111023.log
edex-ingest-gen_areal_qpe-20111023.log
edex-ingestGrib-20111023.log
edex-ingest-purge-20111023.log
edex-ingest-radar-20111023.log
edex-ingest-satellite-20111023.log
edex-ingest-shef-20111023.log
edex-ingest-shef-performance-20111023.log
edex-ingest-smartInit-20111023.log
edex-ingest-text-20111023.log
edex-ingest-unrecognized-files-20111023.log
edex-request-20111023.log
edex-request-productSrvRequest-20111023.log
edex-ingest-archive-20111023.log
edex-ingest-activeTableChange-20111023.log
edex-ingestDat-performance-20111023.log
edex-ingestGrib-performance-20111023.log
edex-ingest-performance-20111023.log
edex-request-performance-20111023.log
edex-ingest-gen_areal_qpe-20111023.log
start-edex-ingest-20111023.log
```

```

start-edex-ingestDat-20111023.log
start-edex-ingestGrib-20111023.log
start-edex-request-20111023.log
edex-request-hibernate-20111023.log
edex-ingest-hibernate-20111023.log
edex-ingest-ohd-20111023.log
edex-request-textdbSrvRequest-20111023.log
edex-ingestDat-performance-20111023.log
edex-request-sportlma-20111023.log
edex-ingestGrib-hibernate-20111023.log

$ tail -f edex-ingest-20111023.log | grep -P "^ERROR .+ Logger:"

(as EDEX Ingest writes errors to the log file they are displayed.)

```

To stop monitoring, press <ctrl-c>.

### **Example 25.7.1-8: Verifying EDEX Ready to Execute**

When an EDEX process is started, it performs a series of initial operations before it is operational, that is, before it is ready to process data or handle client requests. EDEX logs three distinct messages during the startup process:

- *Launching a JVM... is logged as wrapper starts the EDEX process:*
- *\* AWIPS II EDEX ESB Platform is logged as the EDEX process starts.*
- *\* EDEX ESB is now operational is logged once the process is operational.*

*grep* can be used to search the log at startup to determine if the EDEX process is operational. The steps to follow:

```

$ ssh awips@dx3
awips@dx3's password:
$ cd /awips2/edex/logs
$ ls edex*-20111023.log

edex-ingest-20111023.log
edex-ingestDat-20111023.log
edex-ingest-gen_areal_ffg-20111023.log
edex-ingest-gen_areal_qpe-20111023.log
edex-ingestGrib-20111023.log
edex-ingest-purge-20111023.log
edex-ingest-radar-20111023.log
edex-ingest-satellite-20111023.log
edex-ingest-shef-20111023.log
edex-ingest-shef-performance-20111023.log
edex-ingest-smartInit-20111023.log
edex-ingest-text-20111023.log
edex-ingest-unrecognized-files-20111023.log
edex-request-20111023.log
edex-request-productSrvRequest-20111023.log
edex-ingest-archive-20111023.log
edex-ingest-activeTableChange-20111023.log
edex-ingestDat-performance-20111023.log
edex-ingestGrib-performance-20111023.log

```



```

edex-ingest-performance-20111023.log
edex-request-performance-20111023.log
edex-ingest-gen_areal_qpe-20111023.log
start-edex-ingest-20111023.log
start-edex-ingestDat-20111023.log
start-edex-ingestGrib-20111023.log
start-edex-request-20111023.log
edex-request-hibernate-20111023.log
edex-ingest-hibernate-20111023.log
edex-ingest-ohd-20111023.log
edex-request-textdbSrvRequest-20111023.log
edex-ingestDat-performance-20111023.log
edex-ingestGrib-hibernate-20111023.log

$ grep -Pw "Launching|Platform|operational" edex-ingest-
20111023.log

Launching a JVM...
* AWIPS II EDEX ESB Platform *
* EDEX ESB is now operational *
Launching a JVM...
* AWIPS II EDEX ESB Platform *
* EDEX ESB is now operational *

```

This output shows that the EDEX ingest process started and became operational twice on October 23, 2011. Assuming EDEX ingest has not been stopped, it also shows that the EDEX ingest process is ready to process data.

**TIP:** The `-P` option on `grep` allows you to use a *Perl 5* regular expression as the search pattern. The `-w` option instructs `grep` to search for whole word matches only.

### Example 25.7.1-9: Monitoring General EDEX Server Status

The Linux `top` utility can be used to monitor the general status of a server. `top` is designed to provide dynamic real-time view of the system. It provides a system summary and a list of executing tasks on the server.

The basic steps for running `top`:

```

$ ssh awips@dx3
awips@dx3's password:
$ top

```

To exit `top`, either press `q` or `<ctrl-c>`. Typical output is shown in Exhibit 25.7.1-1.

Interesting values to watch are in the PID, VIRT, RES, SHR, %CPU, %MEM and TIME columns. From the top main page:

- **PID:** Process Id.
- **VIRT:** Virtual Image (kb). The total amount of virtual memory used by the task. Includes code, data, and shared libraries plus pages that have been swapped out.
- **RES:** Resident size (kb). The non-swapped physical memory a task has used.

- **SHR:** Shared Mem size (kb). The amount of shared memory used by a task. It simply reflects memory that could be potentially shared with other processes.
- **%CPU:** CPU usage. The task's share of the elapsed CPU time since the last screen update, expressed as a percentage of total CPU time.
- **%MEM:** Memory usage (RES). A task's currently used share of available physical memory
- **TIME:** CPU Time. Total CPU time the task has used since it started. When 'Cumulative mode' is "On," each process is listed with the cpu time that it and its dead children have used.

```
top - 03:25:10 up 73 days, 10:24, 1 user, load average: 2.84, 2.78, 2.77
Tasks: 213 total, 1 running, 212 sleeping, 0 stopped, 0 zombie
Cpu(s): 6.8%us, 2.5%sy, 0.0%ni, 86.9%id, 0.5%wa, 0.4%hi, 2.9%si,
0.0%st
Mem: 8306672k total, 7517240k used, 789432k free, 18520k buffers
Swap: 2199544k total, 6920k used, 2192624k free, 1608884k cached

  PID USER      PR  NI  VIRT  RES  SHR  S  %CPU  %MEM    TIME+  COMMAND
 24175 awips    22   0 1666m 1.3g 17m  S  72.8  16.6   5315:37 java
 17314 awips    20   0 1683m 918m 14m  S  14.3  11.3  380:07.88 java
 22469 root     15   0  2632 1264 924  R   0.3   0.0    0:00.11 top
     1 root     15   0   2160  540 512  S   0.0   0.0    0:12.62 init
     2 root     RT  -5      0    0    0  S   0.0   0.0    1:28.10 migration/0
     3 root     34  19      0    0    0  S   0.0   0.0    0:18.69 ksoftirqd/0
     4 root     RT  -5      0    0    0  S   0.0   0.0    0:00.00 watchdog/0
     5 root     RT  -5      0    0    0  S   0.0   0.0    0:05.76 migration/1
     6 root     34  19      0    0    0  S   0.0   0.0    0:00.87 ksoftirqd/1
     7 root     RT  -5      0    0    0  S   0.0   0.0    0:00.00 watchdog/1
     8 root     RT  -5      0    0    0  S   0.0   0.0    0:07.58 migration/2
     9 root     34  19      0    0    0  S   0.0   0.0    0:00.35 ksoftirqd/2
    10 root     RT  -5      0    0    0  S   0.0   0.0    0:00.00 watchdog/2
    11 root     RT  -5      0    0    0  S   0.0   0.0    0:06.77 migration/3
    12 root     39  19      0    0    0  S   0.0   0.0    0:02.91 ksoftirqd/3
    13 root     RT  -5      0    0    0  S   0.0   0.0    0:00.00 watchdog/3
    14 root     RT  -5      0    0    0  S   0.0   0.0    0:08.81 migration/4
    15 root     34  19      0    0    0  S   0.0   0.0    0:00.34 ksoftirqd/4
    16 root     RT  -5      0    0    0  S   0.0   0.0    0:00.00 watchdog/4
    17 root     RT  -5      0    0    0  S   0.0   0.0    0:05.04 migration/5
    18 root     34  19      0    0    0  S   0.0   0.0    0:01.11 ksoftirqd/5
    19 root     RT  -5      0    0    0  S   0.0   0.0    0:00.00 watchdog/5
    20 root     RT  -5      0    0    0  S   0.0   0.0    0:08.65 migration/6
    21 root     34  19      0    0    0  S   0.0   0.0    0:00.36 ksoftirqd/6
    22 root     RT  -5      0    0    0  S   0.0   0.0    0:00.00 watchdog/6
    23 root     RT  -5      0    0    0  S   0.0   0.0    0:04.72 migration/7
    24 root     34  19      0    0    0  S   0.0   0.0    0:01.04 ksoftirqd/7
```

**Exhibit 25.7.1-1. Basic top Display**

### **Example 25.7.1-10: Monitoring Just the EDEX Processes**

*Top* supports several command line options; one of the most useful is the ability to select the processes to monitor. This is done using the *-p* flag. The basic syntax is

**top -p PID1[, PID2[, PID3 ...]]**

This can be used to have *top* monitor just the EDEX processes. The steps to follow:

```
$ ssh root@dx3
root@dx3's password:
$ /etc/init.d/edex_camel status | grep java
EDEX Camel (ingest) is running (java PID 24175)
EDEX Camel (ingestGrib) is running (java PID 24274)
EDEX Camel (ingestDat) is running (java PID 17314)
EDEX Camel (request) is running (java PID 14130)

$ top -p 24175, 24274, 17314, 14130
```

To exit *top*, press either *q* or *<ctrl-c>*. Typical output is shown in Exhibit 25.7.1-2.

```
top - 03:32:22 up 73 days, 10:31, 1 user, load average: 2.08, 2.41, 2.58
Tasks:  4 total,   0 running,  4 sleeping,  0 stopped,  0 zombie
Cpu(s): 14.5%us,  3.0%sy,  0.0%ni, 79.6%id,  0.7%wa,  0.3%hi,  1.9%si,
0.0%st
Mem:   8306672k total,  7715440k used,   591232k free,   23132k buffers
Swap: 2199544k total,   6920k used,  2192624k free,  1755508k cached
```

PID	USER	PR	NI	VIRT	RES	SHR	S	%CPU	%MEM	TIME+	COMMAND
24175	awips	22	0	1677m	1.3g	17m	S	117.6	16.6	5323:16	java
24274	awips	22	0	1529m	1.3g	17m	S	6.0	16.7	458:16.28	java
14130	awips	17	0	2718m	1.8g	17m	S	4.0	22.9	73:18.21	java
17314	awips	20	0	1683m	918m	14m	S	0.0	11.3	381:46.94	java

**Exhibit 25.7.1-2. Top Display with Selected Processes**

### 25.7.2 Using the JConsole Tool

The JConsole tool has been part of the standard Java release since Java 1.5. It provides a GUI interface into an executing Java program and is a basic tool for monitoring the EDEX Processes. JConsole utilizes the Java Management Extension (JMX) to provide a low-impact view into the internals of a Java application.

EDEX has been configured to support JConsole connectivity options that allow both local and remote monitor monitoring.

In this context, “local” means logged onto the server as the user, normally awips, running EDEX. This also means that we must first identify the PID of the AWIPS Process we want to monitor. Finally, because JConsole is a GUI based application, you will need to export display from the EDEX server being monitored to the workstation. If you log into the server using *ssh*, the *-X* flag may be used to export display.

Remote monitoring allows a user to monitor the EDEX without logging into the server running EDEX. In order to do so you need the hostname of the server and the port the EDEX instance exposes for JConsole monitoring. The ports currently exposed by EDEX are listed in Table 25.7.2-1.

**Table 25.7.2-1. EDEX JConsole Ports**

Process	Token	JConsole Port
EDEX Request	request	1616
EDEX Ingest	ingest	1617
EDEX GRIB Ingest	ingestGrib	1618
EDEX DAT Ingest	ingestDAT	1619

**NOTE:** Remote monitoring requires that Java 1.5 or later be installed on the computer running JConsole.

The next few recipes discuss using JConsole to interact with the running EDEX processes.

**NOTE:** When possible, remote monitoring should be used for monitoring; this results in a lower processing load on the EDEX server.

### **Example 25.7.2-1: Using JConsole to Monitor an EDEX Process**

This recipe presents the basics for using JConsole. There are two scenarios: local monitoring of the EDEX process; and remote monitoring of the EDEX process. In the next few recipes, it will be assumed that the steps provided in this recipe are used to start JConsole.

#### **Scenario 1: Using JConsole in Local Monitoring Mode**

For local monitoring, you need to be logged into the EDEX server using the same account that is running EDEX. Normally, this is the *awips* account.

The steps to follow to initiate a JConsole connection to an operating EDEX ingest process:

```
$ ssh -X awips@dx3
awips@dx3's password:
$ /etc/init.d/edex_camel status ingest | grep java
EDEX Camel (ingest) is running (java PID 13603)
$ /awips2/java/bin/jconsole 13603 &
$
```

For the other EDEX processes, replace *ingest* with the token for the desired EDEX process. (See section 25.2.2, [Operational Considerations](#) for a list of EDEX processes.)

#### **Scenario 2: Using JConsole in Remote Monitoring Mode**

For remote monitoring you will need two items – the host name of the EDEX server and the connection port. The command line format for remote connection is:

```
jconsole host:port.
```

In this recipe, we will connect to the EDEX Ingest process on DX3. The port used by the EDEX request process is 1616, see section 25.7.2, [Using the JConsole Tool](#) (Table 25.7.2-1) for a list of ports for the other EDEX processes.

**NOTE:** This scenario assumes that Java 1.5 or better has been installed on the workstation and that the JConsole executable is in the path.

The steps to follow to initiate a remote JConsole connection to an operating EDEX Request process:

(Open a terminal window on your workstation.)

```
$ jconsole dx3:1616 &
$
```

In both scenarios, JConsole starts with the *Overview* tab selected. The display will be similar to Exhibit 25.7.2-1.

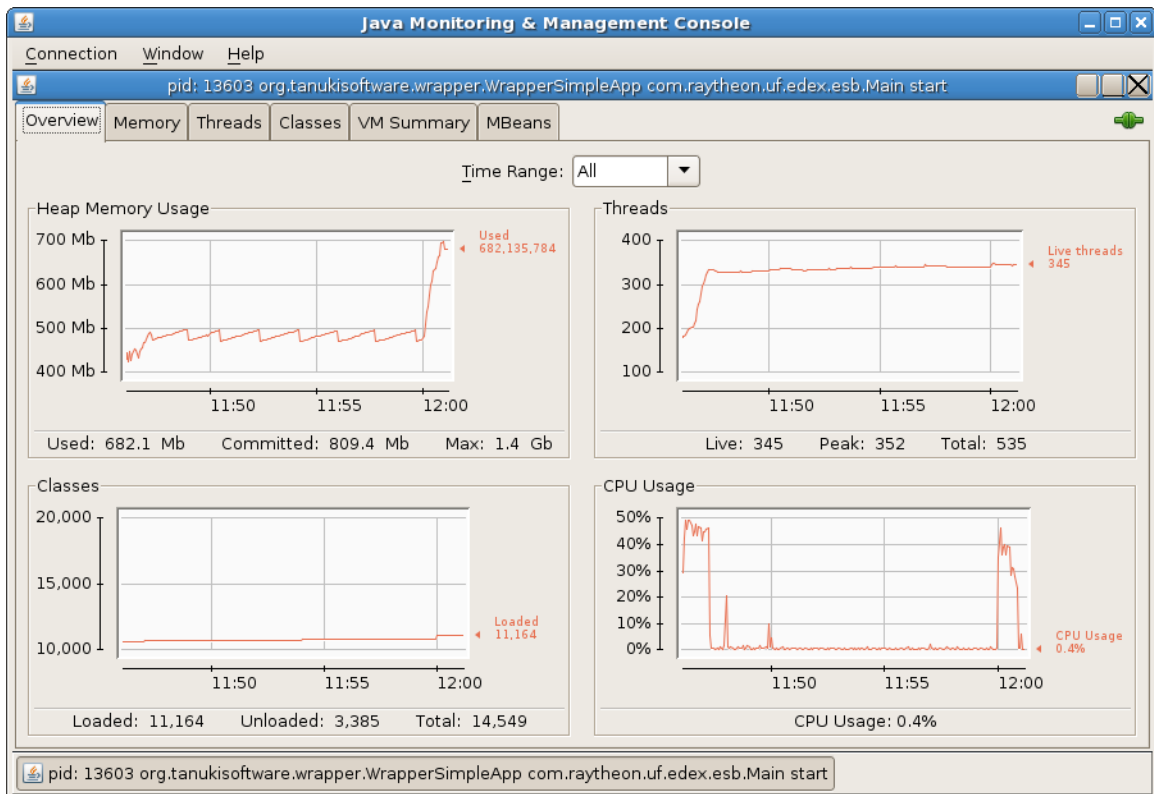

**Exhibit 25.7.2-1. Initial JConsole Display**

JConsole has six tabs that provide different views into the running application. Of these, the most useful are:

- *Overview:* Provides a general view of the application
- *Memory:* Provides detailed information on memory usage by the application.
- *MBeans:* Provides access into detailed information and (some) control of the processes.

**TIP:** This recipe uses one of the command line options available for starting JConsole. Use `/awips2/java/bin/jconsole -h` to see the other options.

### Example 25.7.2-2: Using JConsole to Examine Data Ingest Status

The MBeans tab on JConsole provides a means to examine the inner workings of the various components that make up EDEX. The various components of EDEX, as shown in Exhibit 25.7.2-2, are known as MBeans; this means they expose attributes that can be displayed in JConsole. They may also expose operations that can be executed from JConsole. This recipe looks at some of the component data that is available via that page. For illustrative purposes, we will examine the data available in the Radar decoder service. Other data types may be examined using the same basic steps.

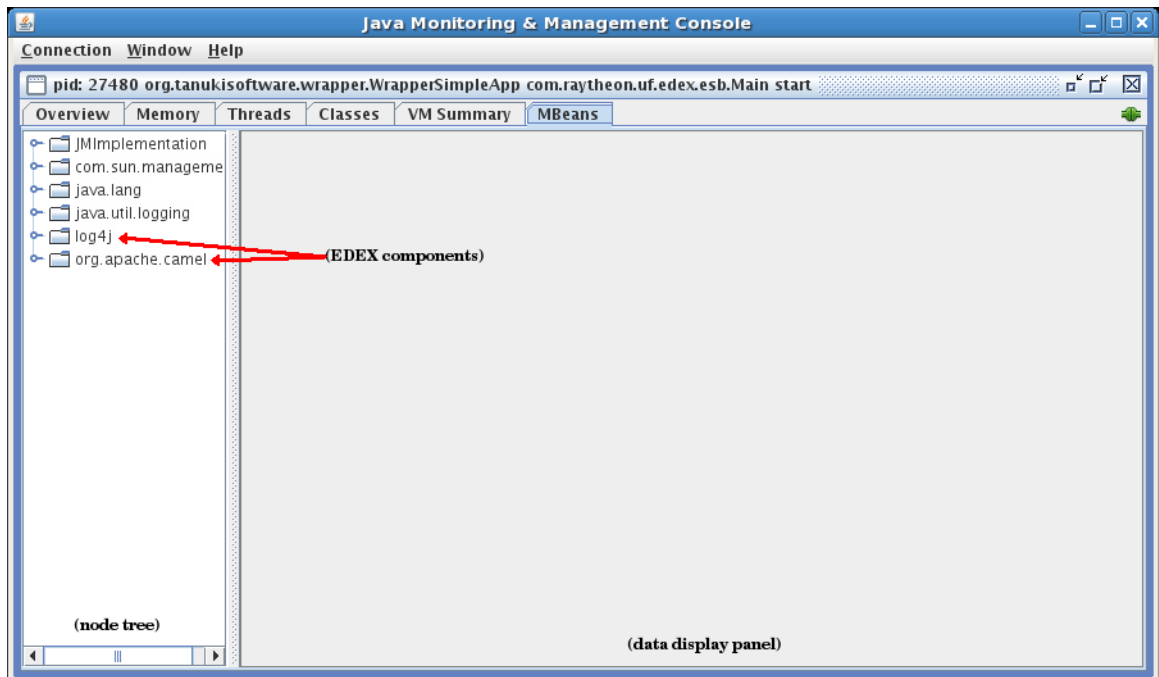
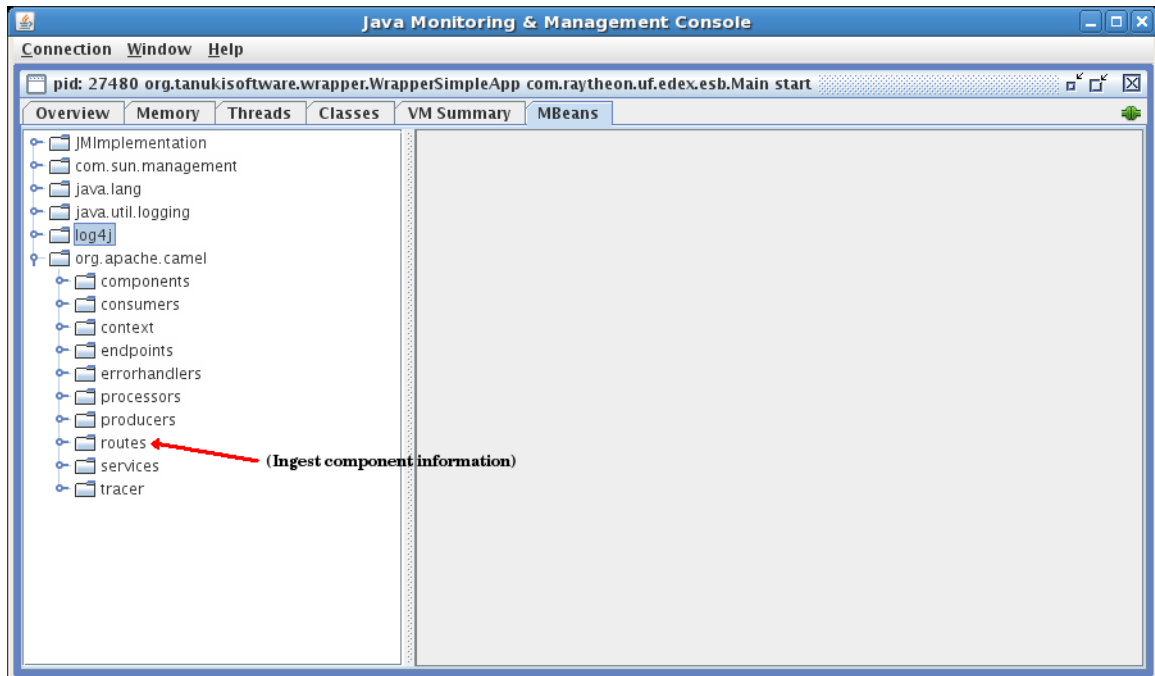

Exhibit 25.7.2-2. JConsole MBean Tab, Initial Display

Follow the basic steps in [Example 25.7.2-1/Scenario 2](#) to start JConsole monitoring the EDEX ingest process on DX3. Once JConsole is running, click the *MBeans* tab. This will display the *MBeans* browser, which is a fairly standard tree browser. On the left is an expandable tree view of the process' MBeans, while the right side is used to display information about the selected node of the MBeans tree.

The initial tree display presents the top-level view of the components visible in JConsole. Of these, *log4j* and *org.apache.camel* are the nodes containing EDEX components, as shown in Exhibit 25.7.2-3. Clicking the *toggle* in front of a node name in the tree expands that node; selecting a node name displays available information on that node.



**Exhibit 25.7.2-3. JConsole MBean Tab with org.apache.camel Expanded**

The nodes under *org.apache.camel* provide information about both the EDEX components and the Camel framework on which they are running. (The node is named *org.apache.camel* because EDEX runs within the Camel framework.) Of the nodes under *org.apache.camel* the one providing the most status information is the *routes* node, as shown in Exhibit 25.7.2-4, which displays a partial listing of Camel routes. Roughly speaking, a Camel route equates to an EDEX service. (Technically, this list contains Camel contexts.)

The names of the route nodes are *<host>/node*. In particular, the name of the Camel route node for Radar ingest is *<host>/node*. Note that the *<host>* name is a fully qualified domain name.

**NOTE:** The images in this recipe were captured from a development server (awips-dev1.oma.ray.com) running the build of EDEX. On a production system, the computer name will change appropriately.

Clicking the toggle to expand the *radar-camel* node, we see that radar-camel has two beans listed – *radarFileConsumerRoute* and *radarIngestAlert*. See Exhibit 25.7.2-5.

Ingest components will normally have a route with a name like *dataIngestRoute*. Note the naming pattern; the data type name is followed by the *IngestRoute*. This bean provides the information on the status of the ingest component.

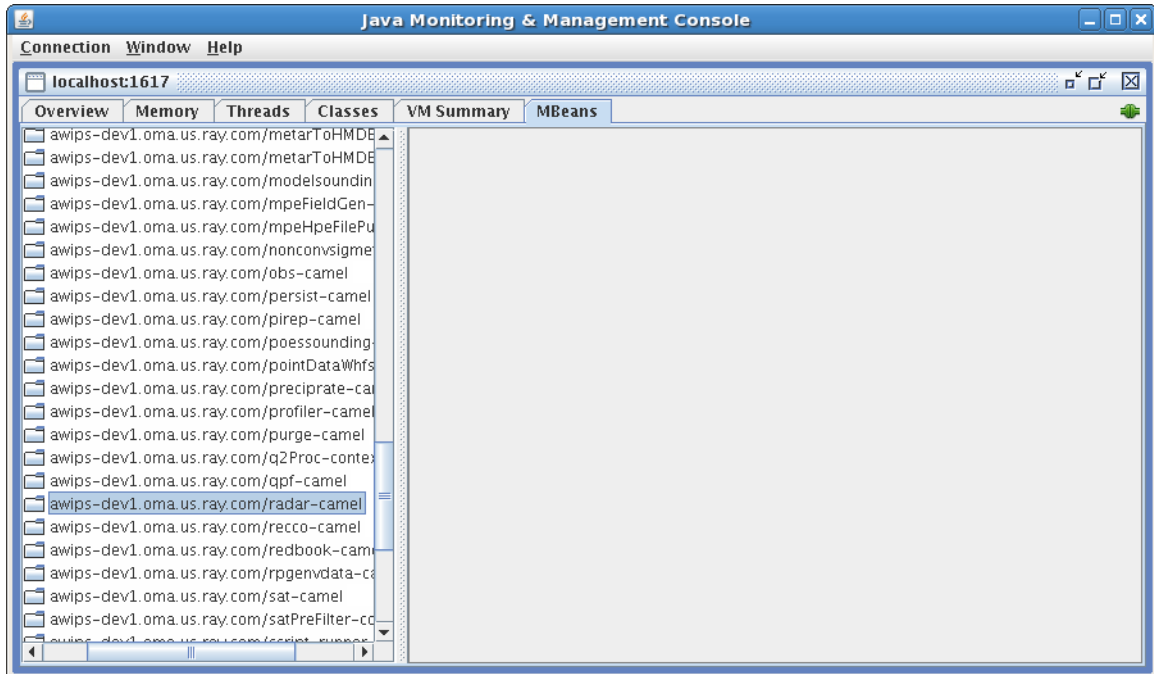

Exhibit 25.7.2-4. Partial Listing of Camel Routes

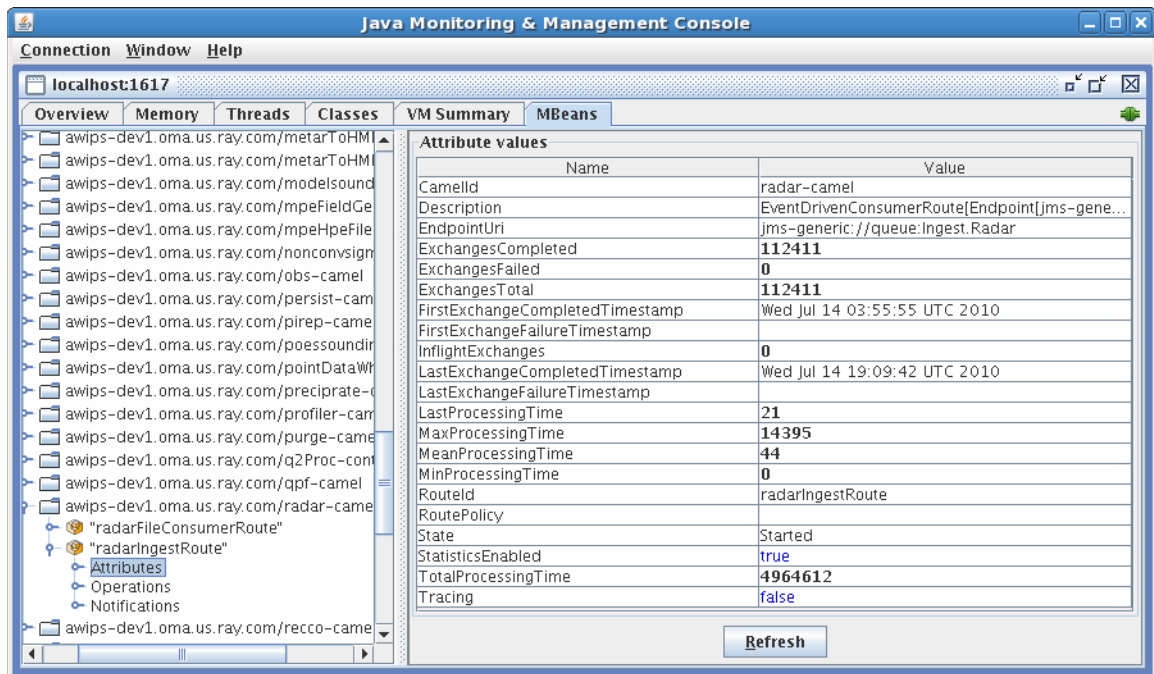

Exhibit 25.7.2-5. Radar Decoder Route with Attributes Displayed

Clicking the toggle on the `radarIngestRoute`, we see that the `radarIngestRoute` can display Attributes, Operations, and Notifications. Selecting *Attributes* displays the attributes in the data display panel.



Of the attributes listed, the most interesting are the three “Exchanges” attributes, and the “Processing Time” attributes. These are generally self-explanatory, although the units are not. The processing time attributes are given in milliseconds.

**TIP:** You can generally double click on any numeric attribute to get a real-time graphical view of that attribute.

### Example 25.7.2-3: Using JConsole to Monitor Request Status

The *MBeans* tab on JConsole, as shown in Exhibit 25.7.2-6, provides a means to examine the inner workings of the various components that make up EDEX. The various components of EDEX are known as *MBeans*; this means they expose attributes that can be displayed in JConsole. They may also expose operations that can be executed from JConsole. This recipe looks at some of the component data that is available via that page. For illustrative purposes, we will examine  $\mu$ Engine (Micro Engine) requests.

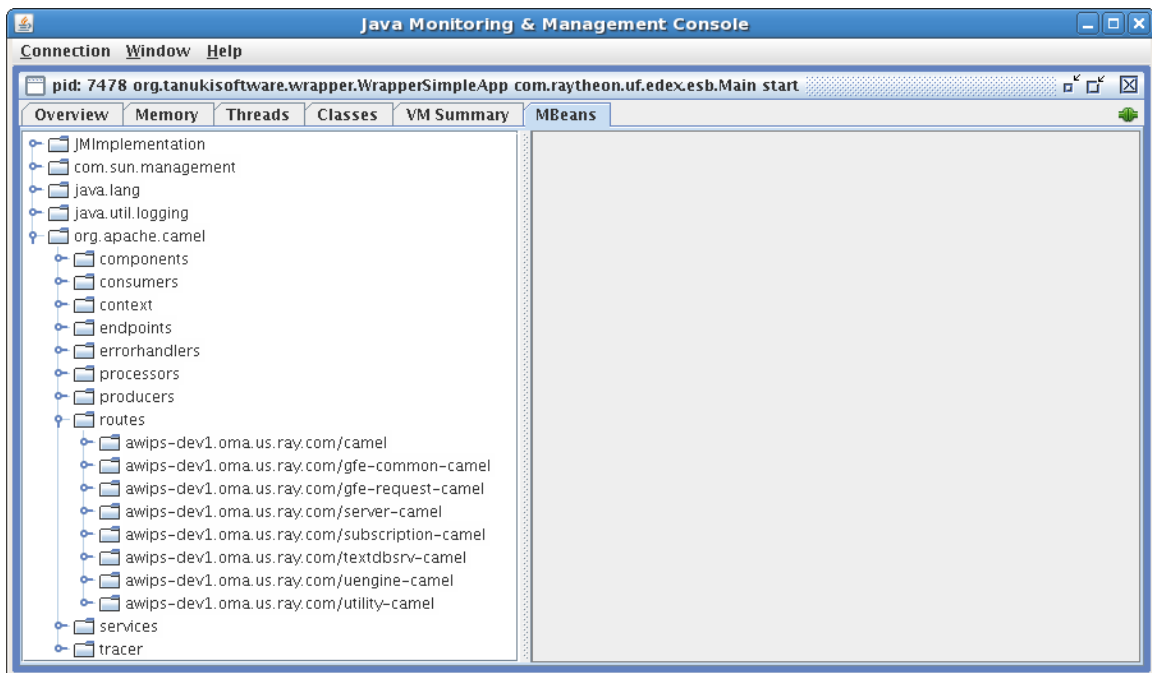

**Exhibit 25.7.2-6. EDEX Request in JConsole with Routes Expanded**

Follow the basic steps in [Example 25.7.2-1/Scenario 2](#) to start JConsole monitoring the EDEX Request process on DX3. Once JConsole is running, click the *MBeans* tab. This will display the *MBeans* browser, which is a fairly standard tree browser. On the left is an expandable tree view of the process' *MBeans*, while the right side is used to display information about the selected node of the *MBeans* tree.

Click the toggle to expand the *org.apache.camel* node of the tree. As with monitoring the ingest process in [Example 25.7.2-2](#), the most useful information is in the tree under the *routes* node. Click the toggle to expand this node.

Micro Engine requests are handled by the *uengine-camel* route (remember, routes are listed as server/route). When we expand this node, we see that the *uengine-camel* has two *Beans* listed – *uEngineHttpJaxb* and *uEngineHttpThrift*. These beans represent the two ways a client can submit requests to the Micro Engine. In AWIPS II, CAVE makes all requests via the *uEngineHttpThrift* bean. Thus, the attributes of this bean provide information on the number and time spent on CAVE requests.

Click on the Micro Engine (*uengine-camel*) node and then expand the *uEngineHttpThrift* bean. Finally select the *attributes* node. The result is shown in Exhibit 25.7.2-7.

The screenshot shows the Java Monitoring & Management Console window. The left pane displays a tree view of the application structure, with the *uEngineHttpThrift* bean under the *uengine-camel* route selected. The right pane shows the *Attribute values* table for this bean.

Name	Value
CamelId	uengine-camel
Description	EventDrivenConsumerRoute[Endpoint[h...]
EndpointUri	http://0.0.0.0:9581/services/pyprodu...
ExchangesCompleted	5259
ExchangesFailed	0
ExchangesTotal	5259
FirstExchangeCompletedTimestamp	Tue May 11 12:36:24 UTC 2010
FirstExchangeFailureTimestamp	
InflightExchanges	1
LastExchangeCompletedTimestamp	Tue May 11 13:30:49 UTC 2010
LastExchangeFailureTimestamp	
LastProcessingTime	1
MaxProcessingTime	2701
MeanProcessingTime	25
MinProcessingTime	0
RouteId	uEngineHttpThrift
RoutePolicy	
State	Started
StatisticsEnabled	true
TotalProcessingTime	136520
Tracing	false

Exhibit 25.7.2-7. Micro Engine Http Thrift Bean Attributes

#### Example 25.7.2-4: Using JConsole to Change Logging Thresholds

As discussed previously (see section 25.6.5, [EDEX Logging Levels](#)), the messages being logged to the EDEX process log are controlled in part by changing the threshold level of the appropriate logger. The EDEX server provides a mechanism where this threshold may be changed using JConsole. It is important to realize that this change is temporary – the threshold value will revert to its configured value when the system is restarted.

To illustrate the process, we will change the logging level for the Subscription Service's Script Runner to DEBUG. This threshold change will provide additional log messages in the EDEX process log. The Subscription Service's Script Runner is a Service in the EDEX Ingest process.

To get started, follow the steps in [Example 25.7.2-1/Scenario 2](#) to connect to the EDEX ingest process on DX3. Once connected, select the *MBeans* tab and expand first the *log4j* node and then the *settings* bean, as shown in Exhibit 25.7.2-8.

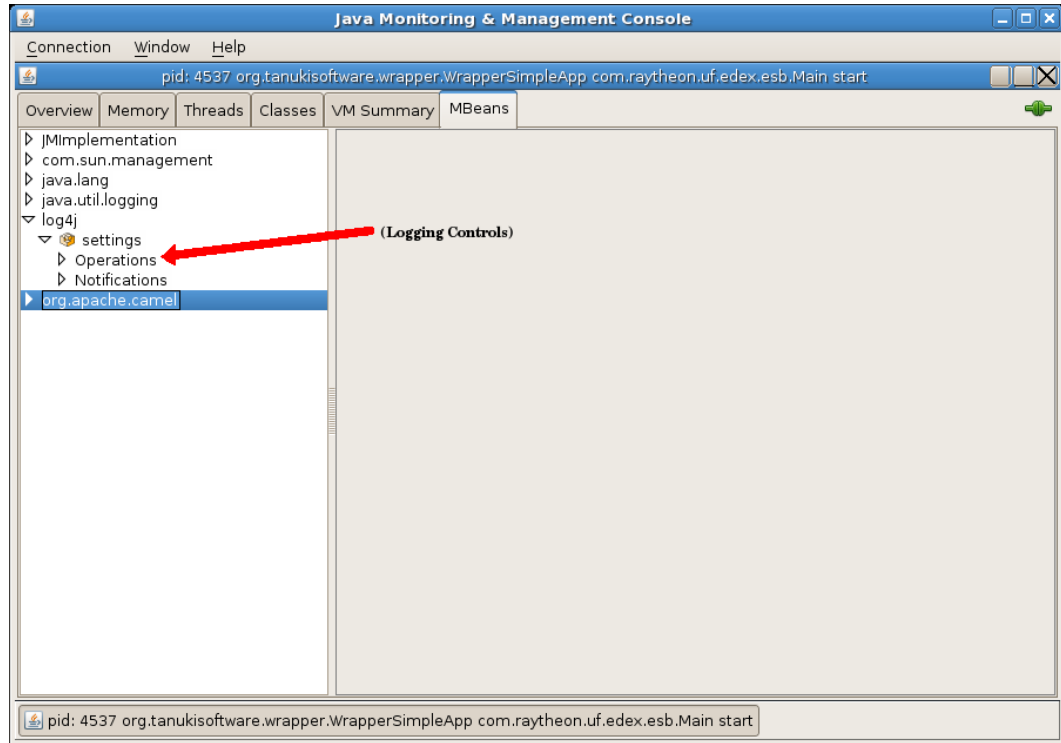

**Exhibit 25.7.2-8. EDEX Logging Controls via JConsole**

The settings *MBean* has no Attributes; controls are listed under the Operations node. Selecting the Operations node displays the list of available operations. (See Exhibit 25.7.2-9.)

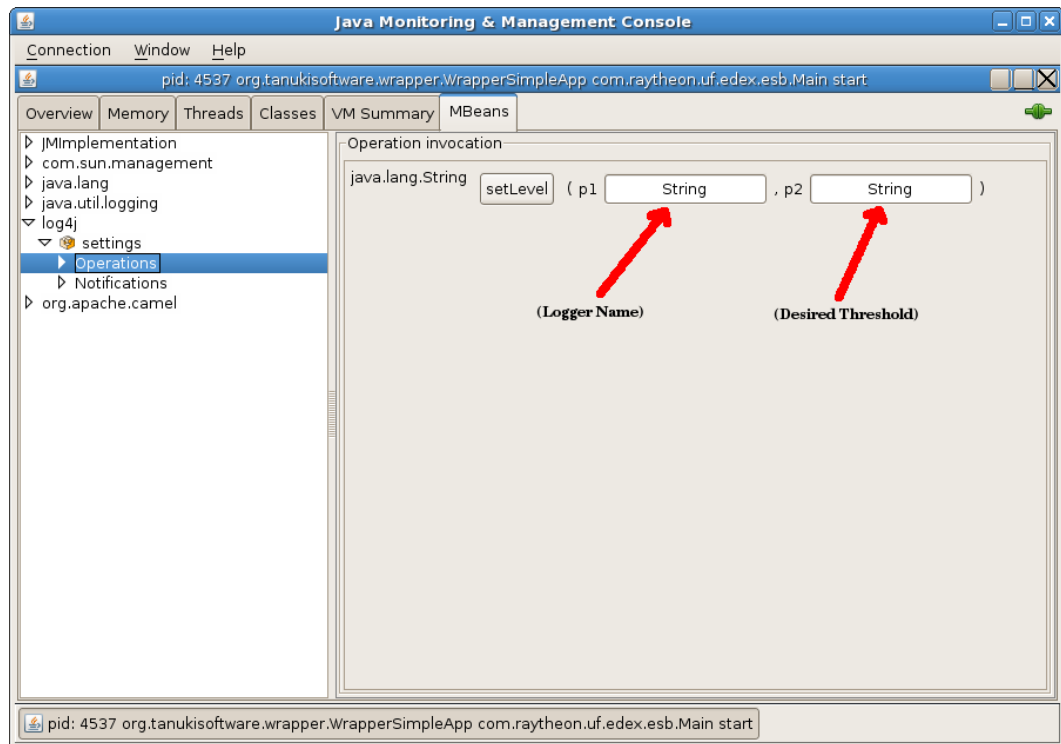

**Exhibit 25.7.2-9. Set Level Operation of the Logging MBean**

Unfortunately, JConsole does not provide a very user friendly display of the available operations. The display lists the method name for the operation correctly, but the user inputs are identified simply as p1, p2, p3, etc. The JConsole GUI does identify the expected type of each input and does provide a text box for entering the value.

For setting EDEX Logging Thresholds, the Operation is called *setLevel*. *setLevel* takes two string arguments – the name of the logger (labeled as p1) and the new logging threshold (labeled as p2). The logging thresholds are simply the logging levels listed in Section 25.6.5, [EDEX Logging Levels](#): DEBUG; INFO; WARNING; ERROR; and FATAL.

To change the logging threshold for the Subscription Service's script runner, we will set the following loggers to DEBUG:

**com.raytheon.edex.services.ScriptRunner**  
**com.raytheon.edex.subscription**  
**com.raytheon.edex.uengine.runners**

**NOTE:** This changes the logging threshold for any class having one of these strings as the prefix of its package. (The first one is a class, but the others could result in unexpected additional logging. Sorry, but that's the way LOG4J works.)

Refer to Exhibit 25.7.2-9. Enter the first logger name, *com.raytheon.edex.services.ScriptRunner*, in the p1 text box, then enter DEBUG in the p2 text, and then click *setLevel*. The update status message is displayed in a separate dialog, as shown in Exhibit 25.7.2-10. Click *OK* to close the dialog.

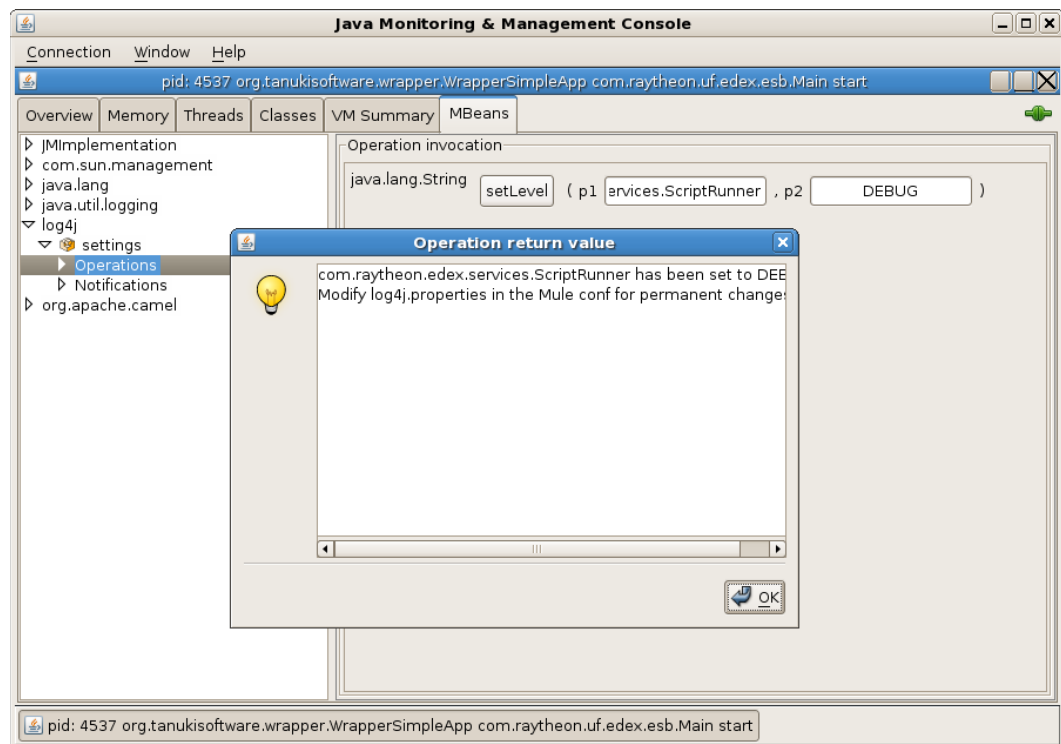

**Exhibit 25.7.2-10. Changing a Logging Level**

Repeat the process for the other two loggers (com.raytheon.edex.subscription and com.raytheon.edex.uengine.runners).

To verify the change, monitor the EDEX log. You should start seeing DEBUG level logging. In particular, you should start see DEBUG level messages similar to *ScriptRunner: script runner fired: type= timer, trigger= [1273594140002]*.

**TIP:** The logging threshold will only be in effect until EDEX is restarted.

## 25.8 Other EDEX-Related Monitoring

While the EDEX processes run on DX3 and DX4, they rely on processes running on other servers for operation. Key among these are the database, running on DX1/2, the QPID Message Broker, running on CP1/2, the Radar Server, running on DX1/2, and the LDM data manager, running on CP1/2. These processes are discussed in this section. Also discussed is the HDF5 data store, which is accessible via /awips2/edex/data/hdf5 from either DX3 or DX4.

**NOTE:** There are tools other than those discussed in this section that may be used for monitoring. Some of these tools are standard Linux utilities. This section is limited to tools that are either 1) part of the standard RedHat Linux distribution, or 2) delivered as part of the AWIPS II distribution.

### 25.8.1 Monitoring the Database

This document limits the discussion of database monitoring to EDEX-related monitoring. In the recipes presented, only Linux tools and database tools delivered with the EDEX installation are discussed.

#### *Example 25.8.1-1: Identifying the Database Used by EDEX*

When EDEX is installed, the installer sets the Database Host and Port into the EDEX environment file, /awips/edex/bin/setup.env. This file is sourced at EDEX startup to set the runtime environment for EDEX. Examining this file allows you to determine the server name and port of the database EDEX is using to store data.

The lines containing the information start *export DB\_ADDR* and *export DB\_PORT*. We can use *grep* to extract this information from the startup script. The steps to follow:

```
$ ssh awips@dx3
awips@dx3's password:
$ cd /awips2/edex/bin
$ grep -P "^export DB" setup.env
export DB_ADDR=dx1f
export DB_PORT=5432
$
```

**TIP:** The information obtained here is used each time we want to connect to the database.

**NOTE:** Other Linux tools, such as *less* or *view*, can be used to examine the EDEX environment file. In this case, *grep* was used due to the size (25 lines) of the file and the fact that a search pattern was known.

### **Example 25.8.1-2: Verifying that PostgreSQL Server Is Running**

The Linux *ps* tool may be used to verify that the PostgreSQL server is running. It can also be used to determine the source and status of connections to the database. This check is performed from the database server.

To simplify the output somewhat, we will choose the *-o* option of the *ps* tool. This option allows you to specify the outputs; we will limit the outputs to the process id (pid) and the command line used to start the process (args). The basic steps to follow:

```
$ ssh awips@dx1
awips@dx1's password:
$ ps ax -o pid,args | grep -v grep | grep post
<<filtered output from ps>>
$
```

The output at this point depends on a number of factors; however, if nothing is displayed it means the PostgreSQL server is not running. If PostgreSQL is running you will see output similar to this:

```
14898 /awips/postgres/bin/postmaster -D /awips/data -p 5432
14905 postgres: logger process
14907 postgres: writer process
14908 postgres: wal writer process
14909 postgres: autovacuum launcher process
14910 postgres: stats collector process
14913 postgres: awips postgres 127.0.0.1(50547) idle
14914 postgres: awips fxatext 127.0.0.1(50548) idle
```

This output indicates that the PostgreSQL server consists of the “postmaster” and a number of “postgres” children. The children may be divided into two types: 1) background processes; and 2) client service processes. The background processes have a command line that ends with *process*. Client service processes, which handle client interactions with the PostgreSQL server, include login information from the client, including the IP address of the client. We can use this information for status checking.

To determine if the PostgreSQL server is running, we can change the command to filter for *postmaster* rather than the more general *post*. The basic steps are:

```
$ ssh awips@dx1
awips@dx1's password:
$ ps ax -o pid,args | grep -v grep | grep postmaster
14898 /awips/postgres/bin/postmaster -D /awips/data -p 5432
$
```

As before, if the PostgreSQL server is not running, no output will be displayed.

To get a list of client connections, we can change the original command somewhat to filter for IP addresses. The basic steps are:

```
$ ssh awips@dx1
awips@dx1's password:
$ ps ax -o pid,args | grep-vgrep | grep -P "post.+
\d+\.\.\d+\.\.\d+\.\.\d+"
14913 postgres: awips postgres 127.0.0.1(50547) idle
14914 postgres: awips fxatext 127.0.0.1(50548) idle
$
```

In this case, if there are no client connections, no output is displayed.

Each line of output includes, in order, the following entries: the Process ID (PID) and name of each process, the login name of the client, the IP address of the client, the port used by the client, and the status of the client's connection. In this example, the client is logged in using the *awips* account and has connections to the *postgres* and *fxatext* databases. The login is from the database server itself – indicated by the “local” IP address of 127.0.0.1, and both connections are idle.

### **Example 25.8.1-3: Verifying Database Availability**

Database availability can be verified by attempting to log into the database using the *psql* command line database client, which is normally installed with the AWIPS II software. To complete the login, you may need to specify a password – that depends on the authentication levels set for the database. At this writing, the new AWIPS II databases require passwords; the legacy (AWIPS I) databases utilized by EDEX do not.

To simplify connecting to the database using *psql*, several command line flags may be used. The basic syntax to use is

```
psql -h host -p port -d database -U user
```

where:

- **host** is the host name identified in [Example 25.8.1-1](#).
- **port** is the port identified in [Example 25.8.1-1](#).
- **database** is the database you wish to access.
- **user** is the database user for the login.

For a complete listing of command line options, run *psql --h* from the command line. Running *psql --h* will also identify the defaults for any command line options.

To test the availability of the EDEX database, we will attempt to connect to the *metadata* database as user *awips*. Because we are interested in confirming the availability of the database to EDEX, we will attempt the connection from DX3. The steps to follow:

```
$ ssh awips@dx3
```

```
awips@dx3's password:
$ psql -h dx1 -p 5432 -d metadata -U awips

psql (9.3.5)
Type "help" for help.
metadata=#
```

**NOTE:** Please provide the password if prompted.

This listing shows a complete session connecting to the metadata database as user awips and then logging out. It is important to note that the request for a password shows the connection is accessible. If the database is not available, *psql* will return a message similar to this:

```
Psq1: could not connect to server: Connection refused
Is the server running on host "dx1" and accepting
TCP/IP connections on port 5432?
```

**NOTE:** To save space, the welcome banner was omitted from this listing. It is also omitted from other recipes involving *psql*.

#### **Example 25.8.1-4: Determining Data Type Tables in Metadata Database**

AWIPS II uses the metadata database to store information about ingested data. To get a list of the main table names that store the metadata, we can query a table named *plugin\_info* in that database. The steps to follow:

```
$ ssh awips@dx3
awips@dx3's password:
$ psql -h dx1 -p 5432 -d metadata -U awips
Password for user awips:
metadata=# select name, tablename from plugin_info
metadata-# where database='metadata'
metadata-# and tablename != '<unspecified>';
      name      |  tablename
-----|-----
acarssounding | acarssounding
level          | level
grib           | grib
(more rows are printed - there are 51 rows total)
ldadmanual    | ldad_manual
bufmos        | bufmos
metadata=# \q
$
```

As an example, this result shows that the main table of GRIB is *grib*.



**TIP:** You can spread the sql query over several lines in PSQL; simply press return to at the end of the line. Note that the prompt changes slightly. To execute the query, terminate the line with a semicolon and then press return.

**Example 25.8.1-5: Determine Latest Insertion Time of GRIB Metadata**

One basic method for checking on data flow is to query the latest insertion time of the metadata for a specific data type. Most of the data type tables contain a field named *inserttime* that contains the data/time stamp of the insertion. This is not the same as the valid time of the data,<sup>2</sup> of course, but it can indicate if a decoder is actively performing metadata data inserts.

Note the use of a couple of PostgreSQL functions – *to\_char()* and *now()*. *now()* provides the current data/time on the database server; *to\_char()* is used to modify the print format of the time fields. The steps to follow:

```
$ ssh awips@dx3
awips@dx3's password:
$ psql -h dx1 -p 5432 -d metadata -U awips
Password for user awips:
metadata=# select to_char((select now()),'MM/DD HH24:MI')
metadata-# as "Time Now", to_char((select inserttime
metadata(# from awips.grib order by inserttime desc
metadata(# limit 1),'MM/DD HH24:MI') as "Latest";
      Time Now      |      Latest
-----+-----
      05/11 21:25 | 05/11 21:24
metadata=# \q
$
```

This result shows the current time as well as the most recent insert time for GRIB data. Note that the last insert was at 21:24 while the current time is 21:25.

**TIP:** To check the latest insert time for a different data type, simply change *grib* to the desired data table name.

**TIP:** Given the length of the query, you may want to save it into a file for later use. Assuming the query has been saved to */path/to/file/query.sql*, you execute it by entering *\i /path/to/file/query.sql* at the psql command prompt.”

**Example 25.8.1-6: Determining Database Session Information Using psql**

The *postgres* database contains useful information about the database that may be queried to help determine the state/health of the database. Two useful tables are the *pg\_database* table and the *pg\_stat\_activity* table. The *pg\_database* table provides information about

<sup>2</sup> In most tables, the valid time of the data is contained in a field named *reftime*.

the databases available in the PostgreSQL server; the *pg\_stat\_activity* provides a snapshot of the current activity in the server. In addition, the *information\_schema.columns* table can be used to get a listing of the columns in a specific table. This Example presents two scenarios: 1) determining the available databases; and 2) determining the activity for a specific client.

***Scenario 1: Determine the Databases Available in the PostgreSQL Server on DX1***

To determine the available databases, we connect to the postgres database in the PostgreSQL server on DX1 using *psql*. Note that we make the connection from DX3 because we are interested in the structure of the database used by the EDEX server. (See [Example 25.8.1-1](#) to determine the database used by EDEX on DX3.) We then query the *pg\_database* table to determine the available table names. The steps to follow:

```
$ ssh awips@dx3
awips@dx3's password:
$ psql -h dx1 -p 5432 -d postgres -U awips
    Password for user awips:
postgres=# select table_name,column_name from
postgres-# information_schema.columns
postgres-# where table_name = 'pg_database';
table_name | column_name
-----+-----
pg_database | datname
pg_database | datdba
pg_database | encoding
pg_database | datistemplate
pg_database | dataallowconn
pg_database | datconnlimit
pg_database | datlastsysoid
pg_database | datfrozenxid
pg_database | dattablespace
pg_database | datconfig
pg_database | datacl
(11 rows)

postgres=# select datname as "database"
postgres-# from pg_database
postgres-# where datistemplate='f';
    database
-----
postgres
metadata
fxatext
maps
hd_ob83oax
```

```

dc_ob7oax
hmdb
(7 rows)

postgres=# \q

```

As this output shows, there are six AWIPS II databases available on DX1. As noted before, *postgres* is a standard database that contains general information and is not specific to AWIPS II.

### **Scenario 2: Determining Status of Database Clients**

To determine client status with the PostgreSQL server, we connect to the *postgres* database in the PostgreSQL server on DX1 using *psql*. Note that we make the connection from DX3 because we are interested in client connections of the database used by the EDEX server. (See [Example 25.8.1-1](#) to determine the database used by EDEX on DX3.)

Once connected, we will first query the *pg\_stat\_activity* table to determine the status of each database connection. The columns to query are somewhat arbitrarily chosen; several “trial and error” queries were attempted before deciding on the query shown here. The *as* modifier is used on some columns in the query to provide more readable output. In addition, the *where* clause is used to filter out the activity created by running this query.

Also note the use of a couple of PostgreSQL functions; *to\_char()* and *now()*. *now()* provides the current data/time on the database server; *to\_char()* is used modify the print format of the time fields. The steps to follow:

```

$ ssh awips@dx3
awips@dx3's password:
$ psql -h dx1 -p 5432 -d postgres -U awips
postgres=# select table_name,column_name from
postgres-# information_schema.columns
postgres-# where table_name = 'pg_stat_activity';
   table_name   | column_name
-----+-----
pg_stat_activity | datid
pg_stat_activity | datname
pg_stat_activity | procpid
pg_stat_activity | usesysid
pg_stat_activity | username
pg_stat_activity | current_query
pg_stat_activity | waiting
pg_stat_activity | xact_start
pg_stat_activity | query_start
pg_stat_activity | backend_start
pg_stat_activity | client_addr
pg_stat_activity | client_port
(12 rows)

```

```

postgres=# select datname,username,current_query as
postgres-# status,to_char(backend_start,'MM/DD HH24:MI')
postgres-# as start_time,client_addr as client
postgres-# from pg_stat_activity where current_query
postgres-# not like '%pg_stat_activity%';
 datname | username | status | start_time | client
-----+-----+-----+-----+-----
 postgres | awips    | <IDLE> | 05/19 15:04 | 127.0.0.1
  fxatext | awips    | <IDLE> | 05/19 15:04 | 127.0.0.1
  dc_ob7oax | awips    | <IDLE> | 05/19 15:04 | 127.0.0.1
 metadata | awips    | <IDLE> | 05/19 17:14 | 127.0.0.1
 metadata | awips    | <IDLE> | 05/19 15:46 | 127.0.0.1
(5 rows)

postgres=# select to_char(now(),'MM/DD HH24:MI') as now;
      now
-----
 05/19 17:33
(1 row)

postgres=# \q
$

```

This output gives a snapshot of the client activity for each database that is currently engaged. As we can see, there are a total of five client connections, all of which are currently idle. Displaying the start time and then querying for the current time provides an idea of how long each connection has been in use.

**NOTE:** Some of the queries used by AWIPS II are rather long, so the output may not be this brief.

**NOTE:** The sample output was produced by querying an isolated database; in an active AWIPS II installation, the number of connections will be considerably higher.

### ***Example 25.8.1-7: Determining Data Type Tables in Metadata Database (Revisited)***

When combined, [Example 25.8.1-4](#) and [Example 25.8.1-5](#) present a method for determining the latest insertion time for the AWIPS II GRIB metadata table. This Example presents additional information on how this was done. The intent is to present a pattern of queries that can be adapted to mine other data from the database.

Generally, we will follow these steps:

1. Connect to the database server using *psql*.
2. Query to determine available schema in the database.
3. Query to determine the tables in the schema.
4. Query to determine the fields in the desired table.

### 5. Query to determine contents of a specific table.

When possible, *where* clauses should be used to limit queries. For example, many of the PostgreSQL elements have a name that is prefaced with “pg\_”. These can be filtered out using a *where* clause similar to *where <<field name>> not like 'pg\_%'*.

Following this general outline, the steps to follow are:

```
$ ssh awips@dx3
awips@dx3's password:
$ psql -h dx1 -p 5432 -d metadata -U awips
Password for user awips:
metadata=# select table_name,column_name
metadata-# from information_schema.columns
metadata-# where table_name='schemata';
  table_name |          column_name
-----+-----
  schemata   | catalog_name
  schemata   | schema_name
  schemata   | schema_owner
  schemata   | default_character_set_catalog
  schemata   | default_character_set_schema
  schemata   | default_character_set_name
  schemata   | sql_path
(7 rows)

metadata=# select catalog_name,schema_name
metadata-# from information_schema.schemata
metadata-# where schema_name not like 'pg_%'
metadata-# and schema_name not like 'information_%';
  catalog_name | schema_name
-----+-----
  metadata     | public
  metadata     | awips
  metadata     | subscription
  metadata     | vtec
(4 rows)

metadata=# select table_name,column_name
metadata-# from information_schema.columns
metadata-# where table_name = 'pg_tables';
  table_name | column_name
-----+-----
  pg_tables  | schemaname
  pg_tables  | tablename
  pg_tables  | tableowner
  pg_tables  | tablespace
```

```

pg_tables | hasindexes
pg_tables | hasrules
pg_tables | hastriggers
(7 rows)

metadata=# select schemaname,tablename
metadata=# from pg_tables
metadata=# where schemaname = 'awips'
metadata=# order by tablename asc;
  schemaname |          tablename
-----+-----
awips       | acars
awips       | acarsbuilder
awips       | acarssounding
awips       | acarssoundinglayer
awips       | airep
awips       | airmet
awips       | airmet_location
<<several rows deleted>>
awips       | goessounding
awips       | grib
awips       | grib_lambertconformal_coverages
<<a bunch of rows deleted>>
awips       | vil
awips       | warning
awips       | warning_ugczone
(94 rows)

metadata=# select table_name,column_name
metadata=# from information_schema.columns
metadata=# where table_name = 'grib'
metadata=# and column_name like '%time';
 table_name | column_name
-----+-----
grib       | forecasttime
grib       | reftime
grib       | inserttime
(3 rows)

metadata=# select to_char((select now()),'MM/DD HH24:MI')
metadata=# as "Time Now", to_char((select inserttime
metadata9# from awips.grib order by inserttime desc
metadata(# limit 1),'MM/DD HH24:MI') as "Latest";
  Time Now | Latest
-----+-----
05/11 21:25 | 05/11 21:24

```

```
metadata=# \q
$
```

The final query shows that the latest insert time is approximately 1 minute prior to the current time. From this we know the insertions are recent; it does not identify whether the data being inserted is up to date, however.

Here are a couple more notes on these queries. First, the PostgreSQL query engine is geared toward queries into the *public* schema of a database. To query into other schemata, you need to preface the table name with the schemata name, for example, *information\_schema.schemata* or *awips.grib*. Second, note that many, but not all, of the AWIPS II metadata tables include an *inserttime* field, so it may be necessary to use a *where* clause similar to *where column\_name like '%time'* to identify time fields to query.

### 25.8.2 Monitoring the Data Store

EDEX uses Hierarchical Data Format (HDF) 5 files to store data that has been ingested. EDEX does not interact directly with the HDF5 repository; rather it interacts with PyPIES, running on the DX2, to access the Data Store. As seen from DX2, the HDF5 Data Store is located in */awips2/edex/data/hdf5*. This directory contains both the HDF5 data store and other directories, notably the *topo* directory, which must be shared between DX1 and DX2 to allow the EDEX servers to operate correctly.

For gridded data, stored in the *grib* directory, and forecast grids, stored in the *gfe* directory, the structure is somewhat different. Gridded data is stored (and purged) by model and model run, so the *grib* directory contains a subdirectory for each model; HDF5 files for each model run are located in each subdirectory. For forecast grids, located under the *gfe* directory, grids are stored by site and specific type and model run.

Although the directory structure varies, there are some general techniques that apply to all data types. These techniques are covered in the Examples in this section.

#### **Example 25.8.2-1: Determining the Disk Space Used by the Data Store**

Disk space with the Data Store is managed by the EDEX Purge Service. This allows the data stored in the HDF5 repository to remain in synch with the metadata in the database. In order to determine optimal data retention rules, it is desirable to determine the disk usage in the Data Store.

The Linux *du* tool can be used to get a rough idea of the size of the Data Store. This information can then be used to determine if retention rules need to be modified to prevent over utilization of disk space. The basic procedure is

```
$ ssh awips@dx3
awips@dx3's password:
$ cd /awips2/edex/data/hdf5
$ du -sh --exclude=topo
42G      .
$
```

This result shows that the data store currently contains approximately 42 GBytes of data. Note that the `--exclude` flag is used to have the topo file not counted.

### **Example 25.8.2-2: Modifying Data Retention Time**

The Purge Service utilizes information packaged with each data decoder plug-in to determine the data retention rules for the plug-in. The data retention rules are then applied to delete records from the database and HDF5 files from the Data Store. Most data plug-ins use a simple, retention time-based purging. The rule here is simple: “If the data is more than X hours old, delete it.” The main plug-in that does not use this strategy is the grib plug-in; it uses a purge strategy based on the desired number of model runs to retain.

Data retention time is tracked in the `awips.plugin_info` table, which is in the metadata database in AWIPS II. The key fields are `name`, which identifies the data type, `retentiontime`, which identifies the number of hours to retain the data. When the Purge Service runs, it queries the database for the retention time; because of this, the retention time for a specific data type can be changed without requiring a restart of the EDEX server.

This Example presents two scenarios: 1) determining retention time; and 2) changing retention time. The data type used to illustrate this process is *satellite*.

#### **Scenario 1: Determining Retention Time for Satellite Data**

The retention time for *satellite* data may be obtained with a simple database query. This can be performed from any computer that has `psql` installed. For consistency with other `psql` examples, we will perform the test from the EDEX server. The basic steps to follow:

```
$ ssh awips@dx3
awips@dx3's password:
$ psql -h dx1 -p 5432 -d metadata -U awips
Password for user awips:
metadata=# select name, retentiontime
metadata=# from awips.plugin_info
metadata=# where name = 'satellite';
   name   | retentiontime
-----+-----
 satellite |             24
(1 row)

metadata=# \q
$
```

From this result, we see that the retention time for *satellite* data is 24 hours.



### Scenario 2: Changing Retention Time for Satellite Data

The retention time for *satellite* data is changed by changing its retention time entry in the *plugin\_info* table. This is accomplished using an SQL update command. The update command changes the value in the database. A word of caution: Be very careful running this command; small errors made when using *update* can cause unexpected problems and generally cannot be corrected/rolled back.

For this example, we will first change the *satellite* data retention time to 18 hours and then repeat the query from scenario 1 to confirm the change. The basic procedure is:

```
$ ssh awips@dx3
awips@dx3's password:
$ psql -h dx1 -p 5432 -d metadata -U awips
Password for user awips:
metadata=# update awips.plugin_info
metadata=# set retentiontime = 18
metadata=# where name = 'satellite';
UPDATE 1
metadata=# select name, retentiontime
metadata=# from awips.plugin_info
metadata=# where name = 'satellite';
   name   | retentiontime
-----+-----
 satellite |             18
(1 row)

metadata=# \q
$
```

The next time the Purge Server runs, all *satellite* data more than 18 hours old will be purged.

**TIP:** If you are running the EDEX server from a canned data set, you can avoid having to re-ingest the data by modifying the data retention rule. Simply set the retention time to a *large* number of hours, say 99999 – approximately 11 and a half years – and it will not be purged.

### Example 25.8.2-3: Determining Available Data Types (in the Data Store)

There are several means of determining data availability on the EDEX cluster. Database queries similar to those presented in [Example 25.8.1-4](#) and [Example 25.8.1-5](#) can be used to determine the data type EDEX can process as well as the latest insert time for the various data types. In this Example, we approach the question from the Linux file system. As is frequently the case with file system issues, basic Linux tools such as *ls*, *find*, and *tree* can provide useful information. This Example presents two scenarios; 1) getting a basic listing of available data types; and 2) determining which data types have current HDF5 repositories.

**Scenario 1: Determining available data types**

If *ls* is used to get a listing of the contents of `/awips2/edex/data/hdf5`, we will get a rough indication of the available data types. What we really need, however, is a listing of the subdirectories of `/awips2/edex/data/hdf5` that are the root of a directory tree containing HDF5 files.

A quick check for available data can be performed using the Linux *find* tool. Because available data is in HDF5 files, we use *find* to search for HDF5 files. The basic command is `find . -name "*.h5" |grep -Pv "^\.\/gfe" |cut -d '/' -f 2 > ingest-types.txt`. Unfortunately, the number of HDF5 files on an active EDEX cluster can reach the thousands. As a result, we need to do some filtering of the output from *find* to generate a more compact list. The techniques will be similar to those used in [Example 25.8.1-4](#). The basic steps to follow:

```
$ ssh awips@dx2
awips@dx2's password:
$ cd /awips2/edex/data/hdf5
$ find . -name "*.h5" |grep -Pv "^\.\/gfe" |cut -d '/' -f 2 >
  ingest-types.txt
$ sort ingest-types.txt > sorted-ingest-types.txt
$ uniq sorted-ingest-types.txt ingest-types.txt
$ cat ingest-types.txt
binlightning
bufрасcat
bufrhdw
bufrmosAVN
bufrmosEta
bufrmosGFS
<<several more lines>>
scan
sfcobs
tcg
tcs
topo
vil
```

The final output shows a sorted list of data types that utilize HDF5 for data storage. Note that it does not identify specifics such as GRIB models, satellite regions, or radar types. Those can be determined more easily by searching the database.

**Scenario 2: Determining the latest available data for a data type**

The `-l` flag on the Linux *ls* tool can be used to determine the latest modification time for the contents of a directory. However, what we really want is to find the newest file in a directory structure when only the root of the structure is known.

A quick and dirty check can be performed using some of the options of the Linux *tree* tool. The options to use are `-D` (print modification time), `-f` (print full path information – also suppresses tree style output), `-i` (don't print indentation lines), and `-t`

(sort by modification time). Finally, we will use the *grep* tool to limit the output to HDF5 files and the *cut* tool to reduce the output somewhat. The steps to follow (using *satellite* as the data type):

```
$ ssh awips@dx2
awips@dx2's password:
$ cd /awips2/edex/data/hdf5
$ tree -Dflt satellite |grep -P "\.h5$" |cut -d '/' -f 1
| | |-- [Feb 15 5:25] satellite
| | |-- [Feb 15 4:25] satellite
| | |-- [Feb 15 2:25] satellite
| | |-- [Feb 15 0:55] satellite
| | |-- [Feb 14 23:25] satellite
| | |-- [Feb 14 22:25] satellite
| | |-- [Feb 14 20:25] satellite
| | |-- [Feb 14 18:55] satellite
| | |-- [Feb 14 17:43] satellite
| | |-- [Feb 14 15:56] satellite
| | |-- [Feb 14 14:25] satellite
| | |-- [Feb 14 13:25] satellite
| | |-- [Feb 14 11:25] satellite
| | |-- [Feb 14 10:25] satellite
| | |-- [Feb 14 8:25] satellite
| | |-- [Feb 14 7:25] satellite
| | |-- [Feb 14 5:25] satellite
| | |-- [Feb 17 14:25] satellite
| | |-- [Feb 17 13:25] satellite
| | |-- [Feb 17 11:57] satellite
| | |-- [Feb 17 10:25] satellite
| | |-- [Feb 17 9:55] satellite
| | |-- [Feb 17 8:25] satellite
| | |-- [Feb 17 7:25] satellite
| | |-- [Feb 17 5:57] satellite
| | |-- [Feb 17 4:57] satellite
| | |-- [Feb 17 2:25] satellite
| | |-- [Feb 17 1:55] satellite
| | |-- [Feb 17 0:55] satellite
| | |-- [Feb 16 22:25] satellite
| | |-- [Feb 16 20:09] satellite
| | |-- [Feb 16 19:25] satellite
| | |-- [Feb 16 17:25] satellite
| | |-- [Feb 16 15:55] satellite
| | |-- [Feb 16 14:25] satellite
| | |-- [Feb 16 13:25] satellite
| | |-- [Feb 16 11:25] satellite
```

```
| | |-- [Feb 16 10:25] satellite
| | |-- [Feb 16 8:25] satellite
| | |-- [Feb 16 7:25] satellite
```

In this case, we see that the latest modification to the satellite data stored in HDF5 was at 13.43 on October 25.

Once again, due to the potential number of HDF5 files in the data store on an EDEX cluster, it may be desirable to pipe the output of this command into a file and use a text viewer to examine the file. In this case, we use the Linux *head* tool to view the first few lines of the file. The steps to follow (using *grib* as the data type):

```
$ ssh awips@dx2
awips@dx2's password:
$ cd /awips2/edex/data/hdf5
$ tree -Dflt grid |grep -P "\.h5$" > available-gribs.txt
$ head -n 5 available-gribs.txt

|-- [Jan 16 15:39] grid/1ad-hoc-test/FHAG/1ad-hoc-test-2014-01-16-
14-FH-000.h5
|      |-- [Jan 16 15:20] grid/1ad-hoc-test/FHAG/1ad-hoc-test-
2014-01-16-13-FH-000.h5
|      |-- [Jan 16 13:39] grid/1ad-hoc-test/FHAG/1ad-hoc-test-
2014-01-16-12-FH-000.h5
|      `-- [Jan 16 13:21] grid/1ad-hoc-test/FHAG/1ad-hoc-test-
2014-01-16-11-FH-000.h5
|      |-- [Jan 16 11:12] grid/1test-gfs/FRZ/1test-gfs-2014-01-16-
06-FH-192.h5
|      |-- [Jan 16 11:12] grid/1test-gfs/FRZ/1test-gfs-2014-01-16-
06-FH-171.h5
|      |-- [Jan 16 11:12] grid/1test-gfs/FRZ/1test-gfs-2014-01-16-
06-FH-174.h5
|      |-- [Jan 16 11:12] grid/1test-gfs/FRZ/1test-gfs-2014-01-16-
06-FH-177.h5
|      |-- [Jan 16 11:12] grid/1test-gfs/FRZ/1test-gfs-2014-01-16-
06-FH-180.h5
|      |-- [Jan 16 11:12] grid/1test-gfs/FRZ/1test-gfs-2014-01-16-
06-FH-183.h5
|      |-- [Jan 16 11:12] grid/1test-gfs/FRZ/1test-gfs-2014-01-16-
06-FH-186.h5
|      |-- [Jan 16 11:12] grid/1test-gfs/FRZ/1test-gfs-2014-01-16-
06-FH-189.h5
|      |-- [Jan 16 11:12] grid/1test-gfs/FRZ/1test-gfs-2014-01-16-
06-FH-147.h5
|      |-- [Jan 16 11:12] grid/1test-gfs/FRZ/1test-gfs-2014-01-16-
06-FH-153.h5
|      |-- [Jan 16 11:12] grid/1test-gfs/FRZ/1test-gfs-2014-01-16-
06-FH-156.h5
|      |-- [Jan 16 11:12] grid/1test-gfs/FRZ/1test-gfs-2014-01-16-
06-FH-159.h5
```

```

|          |-- [Jan 16 11:12]  grid/1test-gfs/FRZ/1test-gfs-2014-01-16-
06-FH-162.h5
|          |-- [Jan 16 11:12]  grid/1test-gfs/FRZ/1test-gfs-2014-01-16-
06-FH-165.h5
|          |-- [Jan 16 11:12]  grid/1test-gfs/FRZ/1test-gfs-2014-01-16-
06-FH-168.h5
|          |-- [Jan 16 11:12]  grid/1test-gfs/FRZ/1test-gfs-2014-01-16-
06-FH-141.h5
|          |-- [Jan 16 11:12]  grid/1test-gfs/FRZ/1test-gfs-2014-01-16-
06-FH-144.h5

```

This output is a bit deceptive, however, because the time sorting is performed on files within a single directory. A more accurate result is obtained by either sorting the output file or filtering for a specific *grib* model.

### 25.8.3 Monitoring QPID

QPID is an Advanced Message Queuing Protocol (AMQP) broker that provides for messaging between the various components in the EDEX cluster. It allows for a fairly high level of load balancing within the cluster and helps to minimize the loss of data ingest in the event an EDEX instance experiences an unplanned restart. QPID also allows the LDM to post messages to EDEX; see section 25.3, Basic Data Flow Concepts for details. QPID runs on the CP 1/2 cluster.

#### Example 25.8.3-1: Verifying QPID Execution

QPID execution can be verified by logging onto the CP1 and using either *ps* or *pidof* to verify that the process is running. Note that the actual QPID process is running as *qpidd*.

First, the steps for using *ps*:

```

$ ssh awips@cpsbn1
awips@cpsbn1's password:
$ ps ax -o pid,args | grep qpidd | grep -v grep

20632 /awips2/qpidd/sbin/qpidd --daemon --config
/awips2/qpidd/etc/qpidd.conf

```

This shows that QPID is running; if QPID is not running, there will be no output.

The linux *pidof* tool outputs the process ID (PID) of a process; if the process is not running, a blank line is output. Here are the steps to follow:

```

$ ssh awips@cpsbn1
awips@cpl1's password:
$ pidof qpidd
20632
$

```

**NOTE:** The Linux *pidof* tool is normally installed in */sbin*, which may not be in a user's path. If a *command not found* error is displayed, try using */sbin/pidof*.

**Example 25.8.3-2: Monitoring QPID Execution**

As with the EDEX processes (see [Example 25.7.1-10](#)), the general status of QPID may be monitored using the Linux *top* utility. To do so, we first use *pidof* to determine the PID of the QPID process, and then use the *-p* option on *top* to limit monitoring to the QPID instance. The steps to follow:

```
$ ssh awips@cpsbn1
awips@cp1's password:
$ pidof qpidd
24565
$ top -p 24565
```

To exit *top*, press either *q* or *<ctrl-c>*. Typical output is shown in Exhibit 25.8.3-1.

```
top - 21:02:06 up 91 days, 22:39, 1 user, load average: 0.22, 0.24, 0.13
Tasks:  1 total,  0 running,  1 sleeping,  0 stopped,  0 zombie
Cpu(s):  0.1%us,  0.1%sy,  0.0%ni, 99.8%id,  0.0%wa,  0.0%hi,  0.0%si,
         0.0%st
Mem:  6222480k total,  5657220k used,  565260k free,  385132k buffers
Swap:  2047992k total,      88k used,  2047904k free,  3354092k cached

  PID USER      PR  NI  VIRT  RES  SHR  S  %CPU  %MEM     TIME+  COMMAND
 24565 awips    15   0   599m 279m 6048  S   2.3   4.6  192:46.88  qpidd
```

**Exhibit 25.8.3-1. Top Display Monitoring QPID**

**Example 25.8.3-3: Monitoring QPID Logging**

When it is running, QPID writes */var/log/messages*; this file is owned by *root* and is readable only by *root*, but it can be monitored to provide information on QPID's operation. QPID messages are formatted as follows:

```
<date> <time> <server> qpidd[PID] <message>
```

This format allows you to scan */var/log/messages* for QPID messages; it also allows you to monitor QPID in real time.

**Scenario 1: Scanning for QPID Messages**

This scenario is similar to the recipes for scanning the EDEX process logs, e.g., [Example 25.6.5-1](#) or [Example 25.7.1-3](#). As in those previous recipes, the Linux *grep* utility is our weapon of choice. The steps to follow:

```
$ ssh awips@cpsbn1
awips@cp1's password:
$ cd /var/log
$ grep qpidd messages
```

```
17 14:35:03 cpsbn1-tbw3 qpidd[28596]: 2013-02-17 14:35:03 warning
task overran 2 times by 2ms (taking 200492ns) on average.
```

```
Feb 17 14:35:03 cpsbn1-tbw3 qpidd[28596]: 2013-02-17 14:35:03
warning ManagementAgent::periodicProcessing task overran 1 times by
3ms (taking 3516333ns) on average.
```

```
Feb 17 14:35:12 cpsbn1-tbw3 qpidd[28596]: 2013-02-17 14:35:12
warning ManagementAgent::periodicProcessing task overran 1 times by
3ms (taking 2884244ns) on average.
```

```
Feb 17 14:35:22 cpsbn1-tbw3 qpidd[28596]: 2013-02-17 14:35:22
warning ManagementAgent::periodicProcessing task overran 1 times by
2ms (taking 3276248ns) on average.
```

```
Feb 17 14:35:32 cpsbn1-tbw3 qpidd[28596]: 2013-02-17 14:35:32
warning ManagementAgent::periodicProcessing task overran 1 times by
3ms (taking 3644837ns) on average.
```

```
Feb 17 14:35:42 cpsbn1-tbw3 qpidd[28596]: 2013-02-17 14:35:42
warning ManagementAgent::periodicProcessing task overran 1 times by
3ms (taking 3272384ns) on average.
```

```
Feb 17 14:35:52 cpsbn1-tbw3 qpidd[28596]: 2013-02-17 14:35:52
warning ManagementAgent::periodicProcessing task overran 1 times by
5ms (taking 3560564ns) on average.
```

```
Feb 17 14:36:18 cpsbn1-tbw3 qpidd[28596]: 2013-02-17 14:36:18
warning task overran 1 times by 2ms (taking 3124ns) on average.
```

```
Feb 17 14:36:25 cpsbn1-tbw3 qpidd[28596]: 2013-02-17 14:36:25
warning task overran 1 times by 2ms (taking 5983ns) on average.
```

```
Feb 17 14:36:35 cpsbn1-tbw3 qpidd[28596]: 2013-02-17 14:36:35
warning task overran 1 times by 2ms (taking 6319ns) on average.
```

The displayed messages will vary depending on conditions encountered by QPID. Normally, QPID logs very few messages. If no messages are displayed and QPID is known to be running (see Example 25.8.3-1), you can assume that QPID is running normally.

### ***Scenario 2: Real-Time Scanning of QPID Messages***

This scenario is similar to the recipes for real-time scanning of the EDEX process logs, e.g., [Example 25.7.1-5](#) or [Example 25.7.1-6](#). As in those previous recipes, the trick is to use the Linux *tail* utility to obtain a real-time display of the log and to pipe *tail*'s output to *grep* to filter the display for QPID messages. The basic steps:

```
$ ssh awips@cpsbn1
awips@cpl's password:
$ cd /var/log
$ tail -f messages | grep qpidd
```

```
Feb 17 14:37:52 cpsbn1-tbw3 qpidd[28596]: 2013-02-17 14:37:52
warning ManagementAgent::periodicProcessing task overran 1 times by
2ms (taking 3480204ns) on average.
```

```
Feb 17 14:38:02 cpsbn1-tbw3 qpidd[28596]: 2013-02-17 14:38:02
warning task overran 2 times by 2ms (taking 4613ns) on average.
```

```
Feb 17 14:38:02 cpsbn1-tbw3 qpidd[28596]: 2013-02-17 14:38:02
warning ManagementAgent::periodicProcessing task overran 1 times by
3ms (taking 3402019ns) on average.
```

```
Feb 17 14:38:13 cpsbn1-tbw3 qpidd[28596]: 2013-02-17 14:38:13
warning task overran 3 times by 2ms (taking 5846ns) on average.
```

```
Feb 17 14:38:29 cpsbn1-tbw3 qpidd[28596]: 2013-02-17 14:38:29
warning task overran 2 times by 2ms (taking 6355ns) on average.
```

```
Feb 17 14:38:34 cpsbn1-tbw3 qpidd[28596]: 2013-02-17 14:38:34
warning task overran 4 times by 2ms (taking 116920ns) on average.
```

```
Feb 17 14:38:40 cpsbn1-tbw3 qpidd[28596]: 2013-02-17 14:38:40
warning task overran 2 times by 2ms (taking 4832ns) on average.
```

```
Feb 17 14:38:47 cpsbn1-tbw3 qpidd[28596]: 2013-02-17 14:38:47
warning task overran 3 times by 2ms (taking 57419ns) on average.
```

```
Feb 17 14:38:55 cpsbn1-tbw3 qpidd[28596]: 2013-02-17 14:38:55
warning task overran 5 times by 2ms (taking 5122ns) on average.
```

(As QPID writes messages, the display will update.)

To stop monitoring, press <ctrl-c>.

As in Scenario 1, the absence of messages means QPID is operating correctly.

### 25.8.3.1 QPID Monitoring Tools

QPID supports both stand-alone and clustered operation. Clustered operation facilitates failover operations on the CPSBN cluster, allowing failover of QPID operation without loss of messages. QPID management and monitoring is accomplished by a set of Python language tools that are installed on the CPSBN cluster. As these tools provide both monitoring and management/control functions, care must be taken to avoid operational impact. All examples in this section have been designed to provide monitoring functionality without affecting operations.

QPID monitoring tools are located in /awips2/python/bin on the CPSBN1/2 cluster. They may be installed on other systems as well. This section focuses on five of these tools. They are listed and described in Table 25.8.3.1-1.

**NOTE:** The QPID tools described here can be used with both the clustered and the unclustered QPID. In addition, all the tools have a *-h* option, which will cause the tool to print a usage message and terminate.



**Table 25.8.3.1-1. Basic QPID Tools**

Tool	Usage (Arguments)	Description
qpid-cluster	[options] [host[:port]]	General administration tool. Use to query information and administer the QPID cluster. Monitoring options: -C: view client connections for all cluster members -c: View client connections for a specific cluster member
qpid-stat	[options] [host[:port]]	Displays statistics on QPID operation Monitoring options: -b: show brokers -c: show connections -e: show exchanges -q: show queues -S: sort by a specified column name; msg, msgIn, msgOut and bytes are useful columns -L: limit the number of lines to display
qpid-printevents	[host[:port]]	Provides a real-time view of QPID events. Monitoring options: -h: display usage message <ctrl-C> to terminate
qpid-queue-stats	[options] [-a host[:port]]	Provides a real-time view of QPID queue statistics. Monitoring options: -f: list of queues to monitor, comma separated, regex are accepted <ctrl-C> to terminate
qpid-config	[-a host[:port]] [command]	General QPID administration tool. Use to query and administer QPID. Monitoring commands: queues: prints a list of queues exchanges: prints list of exchanges With no command, summary statistics are printed.

**Example 25.8.3.1-1: Determining the Status of the QPID Cluster**

QPID runs on the CPSBN1/2 cluster. In normal operation, QPID runs in clustered mode. The *qpid-cluster* tool may be used both to determine the status of the QPID cluster and to identify the members of the cluster. This tool is also used to manage the QPID cluster; care must be exercised to avoid affecting operations.

The basic steps to follow:

```
$ ssh root@cpsbn1
root@cpsbn1's password:
$ cd /awips2/python/bin
root@cpsbn1-tbw3 bin]# qpid-stat -b
```

Brokers

```
broker conn  exch  queue
=====
Broker    338      6    205
```

The output above is typical but will vary by site. If QPID is not operating in clustered mode, the following message is printed:

```
Failed: Exception - Clustering is not installed on the broker
```

### Example 25.8.3.1-2: Monitoring QPID Queue Status

The `qpid-stat` tool provides statistics on various QPID activities – queues, brokers, exchanges, and connections. In this example, we monitor the top 10 queues by number of messages in the queue. The output from `qpid-stat` is rather long (generally about 170 characters per line), so `cut` is used to shorten the output length to 145 characters. To provide near real-time display, `watch` is used to update the display every 5 seconds. The basic command for this is **`watch -n 5 “./qpid-stat -q -S msg -L 10 | cut -b -135”`**.

The full procedure:

```
$ ssh awips@cpsbn1
awips@cpsbn1's password:
$ cd /awips2/python/bin
$ watch -n 5 "qpid-stat -q -S msg -L 10 | cut -b -135"
<<results of watch are displayed>>
<ctrl-C>
```

Typical output is shown in Exhibit 25.8.3.1-1.

Every 5.0s: qpid-stat -q -S msg -L 10   cut -b -135								Tue Oct 25 15:51:12 2011	
Queues									
queue								dur	auto
Del	excl	msg	msgIn	msgOut	bytes	bytesIn	bytesO		
=====									
Ingest.dhr									Y
		3.90k	19.0k	15.0k	269k	1.31m	1.04m		
scheduledQCScanWork									
		1.12k	1.13k	14	0	0	0		
watchwarn									Y
		10	3.41m	3.41m	560	198m	198m		
Ingest.RadarRadarServer									Y
		0	0	0	0	0	0		
_edex.alerts.utility@amq.topic_0f77cb37-292b-4682-9eb4-ab1f9a543dd0	Y	0	52	52	0	30.6k	30.6k		Y
_rebuildD2DCache@amq.topic_76c92477-6363-4d2b-b671-71d59afa3aad	Y	0	95	95	0	0	0		Y
Ingest.wcp									
		0	4	4	0	214	214		
Ingest.ffg									
		0	1.65k	1.65k	0	96.3k	96.3k		
satNotification									Y

Exhibit 25.8.3.1-1. Typical Output of qpid-stat for Queue Monitoring

**Example 25.8.3.1-3: Monitoring Individual QPID Queues**

The same general approach can be used to monitor specific queues by piping the output of *qpid-stat* into *grep* with an appropriate pattern. For example, the EDEX ingest processes pull messages from QPID queues whose names start with *Ingest*. We can use this information to monitor ingest queues. As before, use *cut* to shorten the output and *watch* to provide near real-time monitoring. The basic command is **watch -n 5 'qpid-stat -q -S msg | grep -P "Queues|queue|===|Ingest" | cut -b -135**. (The *grep* search string selects lines of output containing *Queues*, *queue*, *===*, or *Ingest*. The first three match the header lines output by *qpid-stat*; the last one catches the ingest queue stats.)

The full procedure:

```
$ ssh awips@cpsbn1
awips@cpsbn1's password:
$ cd /awips2/python/bin
$ watch -n 5 'qpid-stat -q -S msg | grep -P
"Queues|queue|===|Ingest" | cut -b -135'
<<results of watch are displayed>>
<ctrl-C>
$
```

Typical output is shown in Exhibit 25.8.3.1-2.

Queue Name	Sec	Depth	Enq Rate	Deq Rate
=====				
Ingest.Grib	30.00	0	0.40	0.40
Ingest.Radar	10.00	0	1.00	1.00
Ingest.RadarRadarServer	10.00	0	2.50	2.50
Ingest.Satellite	10.00	0	0.20	0.20
Ingest.Shef	30.00	0	0.03	0.03
Ingest.Text	10.00	0	4.80	4.80
Ingest.dhr	20.00	0	0.40	0.40
Ingest.dpa	20.00	0	0.15	0.15
Ingest.lsr	80.01	0	0.01	0.01
Ingest.sfcobs	30.00	0	0.07	0.07
Ingest.Grib	10.00	0	5.60	5.60
Ingest.Radar	10.00	0	0.50	0.50
Ingest.RadarRadarServer	10.00	0	1.80	1.80
Ingest.Satellite	10.00	0	0.10	0.10
Ingest.Text	10.00	0	4.20	4.20
Ingest.acars	60.01	0	0.05	0.05
Ingest.dhr	10.00	0	0.10	0.10
Ingest.dpa	10.00	0	0.10	0.10
Ingest.obs	20.00	0	0.40	0.40
Ingest.redbook	180.02	0	0.01	0.01
Ingest.taf	40.01	0	0.02	0.02
Ingest.Grib	10.00	4	14.00	13.60
Ingest.Radar	10.00	0	1.60	1.60
Ingest.RadarRadarServer	10.00	0	0.60	0.60
Ingest.Satellite	10.00	0	0.30	0.30
Ingest.Shef	20.00	0	0.05	0.05
Ingest.Text	10.00	0	8.50	8.50
Ingest.Warning	120.01	0	0.01	0.01
Ingest.dhr	10.00	0	0.60	0.60

**Exhibit 25.8.3.1-2. Typical Output of qpid-stat Monitoring Ingest Queues**

The *qpid-queue-stats* tool can also be used to provide real-time monitoring of individual queue status. *qpid-queue-stats* provides some filtering; unlike *watch*, the new output is appended to the screen each time the statistics are updated. No sorting is provided; the output lines are shorter, however. The filtering mechanism is for specific queues; regex pattern matching is supported. To use *qpid-queue-stats* to display Ingest queue statistics, the basic command is `./qpid-queue-stats -f Ingest.*`.

The full procedure:

```
$ ssh awips@cpsbn1
awips@cpsbn1's password:
$ cd /awips2/python/bin
$ ./qpid-queue-stats -f Ingest.*
<<results of qpid-queue-stats are displayed>>
<ctrl-C>
```

Typical output is shown in Exhibit 25.8.3.1-3.

Queue Name	Sec	Depth	Enq Rate	Deq Rate
=====				
Ingest.Grib	30.00	0	0.40	0.40
Ingest.Radar	10.00	0	1.00	1.00
Ingest.RadarRadarServer	10.00	0	2.50	2.50
Ingest.Satellite	10.00	0	0.20	0.20
Ingest.Shef	30.00	0	0.03	0.03
Ingest.Text	10.00	0	4.80	4.80
Ingest.dhr	20.00	0	0.40	0.40
Ingest.dpa	20.00	0	0.15	0.15
Ingest.lsr	80.01	0	0.01	0.01
Ingest.sfcobs	30.00	0	0.07	0.07
Ingest.Grib	10.00	0	5.60	5.60
Ingest.Radar	10.00	0	0.50	0.50
Ingest.RadarRadarServer	10.00	0	1.80	1.80
Ingest.Satellite	10.00	0	0.10	0.10
Ingest.Text	10.00	0	4.20	4.20
Ingest.acars	60.01	0	0.05	0.05
Ingest.dhr	10.00	0	0.10	0.10
Ingest.dpa	10.00	0	0.10	0.10
Ingest.obs	20.00	0	0.40	0.40
Ingest.redbook	180.02	0	0.01	0.01
Ingest.taf	40.01	0	0.02	0.02
Ingest.Grib	10.00	4	14.00	13.60
Ingest.Radar	10.00	0	1.60	1.60
Ingest.RadarRadarServer	10.00	0	0.60	0.60
Ingest.Satellite	10.00	0	0.30	0.30
Ingest.Shef	20.00	0	0.05	0.05
Ingest.Text	10.00	0	8.50	8.50
Ingest.Warning	120.01	0	0.01	0.01

**Exhibit 25.8.3.1-3. Typical Output of qpid-queue-stats Monitoring Ingest Queues**

One comment here: These two tools may produce different results. In particular, *qpid-stat* tends to display more Ingest queues than *qpid-queue-stats*.

### 25.8.4 Monitoring IP Virtual Server (IPVS)

The IP Virtual Server (IPVS) is used to load balance the connections from clients (AlertViz, CAVE, etc.) to an EDEX cluster, as shown in Exhibit 25.8.4-1. IPVS is hosted on the CP 1/2 cluster. It is configured so that when an incoming connection request is made to the IPVS IP address, it looks to see which server has the fewest number of connections. It then routes the connection to the server with fewer active connections. If both servers have the same number of active connections, it is configured with DX4 weighted higher than DX3. This means that it will route to DX4 by default if both servers have the same number of active connections.

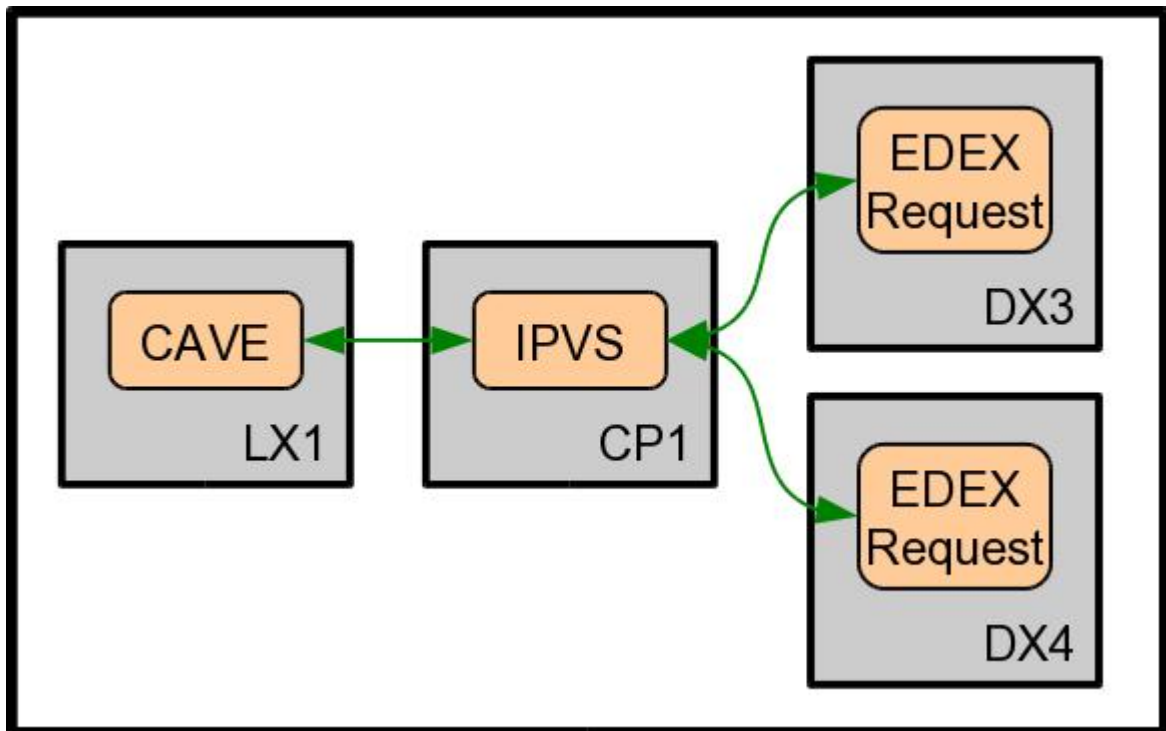

**Exhibit 25.8.4-1. Client Interaction with CAVE via IPVS**

For clients such as CAVE that interact with the EDEX Request process, IPVS allows a single connection string to be used regardless of the number of EDEX servers that are available. CAVE connects to a virtual address that is managed by IPVS on the CP1/2 cluster, shown here as CP1. (The virtual address used by CAVE is TS1.) Once the request is received, IPVS performs a handoff of one of the EDEX request servers, which fulfills the request. This results in a balancing of requests between DX3 and DX4.

IPVS is a standard part of the Red Hat Linux kernel that is installed on CP1/2.

On the clustered server, IPVS is managed by a number of Linux services and tools.

- *pulse* is a Linux heartbeat daemon for monitoring the health of cluster nodes. On a server that is part of a cluster, service pulse status can be used to determine if *pulse* is running; *top* may be used to monitor pulse.

- *lvsd* is the Linux daemon for controlling Red Hat clustering services. It is started by *pulse*. *lvsd* operation may be verified using *ps* and monitored using *top*.
- *nanny* is a Linux tool that monitors the status of services in a cluster. It is used by *pulse* and should not be used directly. *nanny* operation may be verified using *ps* and monitored using *top*.
- *ipvsadm* is the Linux Virtual Server administration management tool. It is used to manage the virtual server table and include some diagnostic/monitoring tools as well. *ipvsadm* must be run as root. When using *ipvsadm* for monitoring, use extreme care in the commands you execute.

The basic interaction of these tools is shown in Exhibit 25.8.4-2.

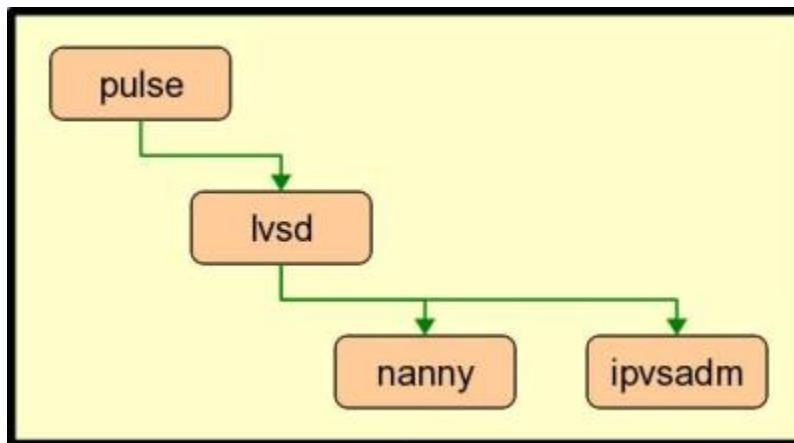

Exhibit 25.8.4-2. Basic Hierarchy of Tools in IPVS

#### Example 25.8.4-1: Verify/Monitor *pulse* Operation

*pulse* is the top-level tool involved in IPVS; it is a Linux daemon that is responsible for managing the cluster. Because IPVS is part of the CP1/2 cluster, *pulse* is ultimately responsible for its execution. If *pulse* is not running on all members of a cluster, cluster failover and other activities will fail. This recipe contains two scenarios: 1) verifying *pulse* execution; and 2) monitoring *pulse* execution using *top*.

##### Scenario 1: Verifying Pulse Execution

*pulse* is a Linux service whose operation may be controlled using the Linux *service* utility. Execution may be verified using *service pulse status*.

The basic steps to follow:

```

$ ssh root@cpsbn1
root@cpsbn1's password:
$ service pulse status
pulse (pid 27173) is running...
$
  
```

You should see output similar to the sample output above. (The actual PID will be different, of course.)

### Scenario 2: Monitoring Pulse Execution Using top

The Linux *top* utility provides for a near real-time picture of computer operation; the *-p* flag is used to limit the processing being watched. The syntax is *top -p <PID list>*.

The basic steps follow, and the *top* output monitoring *pulse* is shown in Exhibit 25.8.4-3.

```
$ ssh root@cpsbnx1
root@cpsbn1's password:
$ service pulse status
pulse (pid 27173) is running...
$ top -p 27173
(Typical top output is shown below, press q to quit top.)
```

```
mfegan@dev07:~
File Edit View Terminal Tabs Help
top - 22:24:02 up 133 days, 1:23, 1 user, load average: 0.01, 0.03, 0.14
Tasks: 1 total, 0 running, 1 sleeping, 0 stopped, 0 zombie
Cpu(s): 0.0%us, 0.1%sy, 0.0%ni, 99.8%id, 0.1%wa, 0.0%hi, 0.0%si, 0.0%st
Mem: 4145316k total, 1921268k used, 2224048k free, 376064k buffers
Swap: 2047992k total, 268k used, 2047724k free, 964068k cached

  PID USER      PR  NI  VIRT  RES  SHR  S  %CPU  %MEM    TIME+  COMMAND
 27173 root        15   0 1884   336  256  S   0.0   0.0   0:00.00 pulse
```

Exhibit 25.8.4-3. Top Output Monitoring *pulse*

### Example 25.8.4-2: Verify/Monitor *lvsd* Operation

*lvsd* is the Linux daemon that is responsible for controlling the clustering. As such, it is part of the chain of tools responsible for the operation of IPVS. As with *pulse*, *lvsd* should be running on all members of a cluster to ensure proper operation of IPVS on the cluster. This Example contains two scenarios: 1) verifying *lvsd* execution; and 2) monitoring *lvsd* execution using *top*.

#### Scenario 1: Verifying *lvsd* Operation

Since *lvsd* is controlled by *pulse*, we use the Linux *ps* tool to verify that it is executing.

The basic steps to follow:

```
$ ssh root@cpsbn1
root@cpsbn1's password:
$ ps ax -o pid,args | grep lvsd | grep -v grep
22787 /usr/sbin/lvsd --nofork -c /etc/sysconf/ha/lvs.cf
$
```

The first entry in the line is the *lvsd* process ID (PID); it will vary depending on the actual PID. In normal operation, you should expect to see a single instance of *lvsd*.

### Scenario 2: Monitoring *lvsd* Operation Using *top*

As with other processes, *lvsd* may be monitored using *top*.

The basic steps follow, and the *top* output monitoring *lvsd* is shown in Exhibit 25.8.4-4.

```
$ ssh root@cpsbn1
root@cpsbn1's password:
$ ps ax -o pid,args | grep lvsd | grep -v grep
22787 /usr/sbin/lvsd --nofork -c /etc/sysconf/ha/lvs.cf
$ top -p 22787
(Typical top output is shown below, press q to quit top.)
```

```
mfegan@dev07:/common/mfegan/viz/cave
File Edit View Terminal Tabs Help
top - 15:22:16 up 190 days, 23:33, 1 user, load average: 0.00, 0.00, 0.00
Tasks: 1 total, 0 running, 1 sleeping, 0 stopped, 0 zombie
Cpu(s): 0.0%us, 0.0%sy, 0.0%ni,100.0%id, 0.0%wa, 0.0%hi, 0.0%si, 0.0%st
Mem: 4145316k total, 1043356k used, 3101960k free, 367352k buffers
Swap: 2047992k total, 268k used, 2047724k free, 97492k cached

  PID USER      PR  NI  VIRT  RES  SHR  S  %CPU  %MEM    TIME+  COMMAND
 22787 root        18   0  1876   604  520  S   0.0   0.0   0:00.00  lvsd
```

Exhibit 25.8.4-4. Top Output Monitoring *lvsd*

### Example 25.8.4-3: Verify/Monitor *nanny* Operation

*nanny* is a Linux tool that is used to monitor the status of services in a cluster. As such, it is used to monitor IPVS to ensure continued operation. Note that *nanny* is started by *lvsd*; as with *lvsd*, *nanny* should be running on all members of a cluster to ensure proper operation of IPVS on the cluster. This recipe contains two scenarios: 1) verifying *nanny* execution; and 2) monitoring *nanny* operation using *top*.

#### Scenario 1: Verifying *nanny* Operation

As with *lvsd*, *nanny* runs as a child process of *pulse*; as a result *nanny* operation is checked using the Linux *ps* tool.

The basic steps to follow:

```
$ ssh root@cpsbn1
root@cpsbn1's password:
$ ps ax -o pid,args | grep nanny | grep -v grep
27213 /usr/sbin/nanny -c -h 155.157.61.161 -p 9581 -s GET /
HTTP/1.0\r\n\r\n -x HTTP -a 15 -I /sbin/ipvsadm -t 6 -w 1 -V
155.157.61.165 -M g -U none --lvs
```



```
27214 /usr/sbin/nanny -c -h 155.157.61.162 -p 9581 -s GET /
HTTP/1.0\r\n\r\n -x HTTP -a 15 -I /sbin/ipvsadm -t 6 -w 2 -V
155.157.61.165 -M g -U none -lvs
$
```

You should see a single line of output for each virtual host. The general format of each line of output is

```
PID /usr/sbin/nanny -c -h <address> -p <port> -s <ping> -x
<response> -a <time> -I <ipvsadm> -t <time> -w weight -V
<address> -M method -U none -lvs
```

The key values are the two addresses in each line. The first address is the IP for a DX server (DX3 or DX4); the second address is the virtual IP address for the IPVS server.

**TIP:** The output from *ps* for *nanny* is extremely long; *cut* can be used to shorten the output of the *grep* output, making the result easier to read. For example, piping the final *grep* in the example above into *cut -d ' ' -f -7* results in

```
27213 /usr/sbin/nanny -c -h 155.157.61.161 -p 9581
27214 /usr/sbin/nanny -c -h 155.157.61.162 -p 9581
```

### Scenario 2: Monitoring nanny Operation Using top

The Linux *top* utility is used to monitor *nanny* operation; in this case there are multiple PIDs to monitor. Note the format of the *top* command.

The basic steps to follow and the *top* output monitoring *nanny* is shown in Exhibit 25.8.4-5.

```
$ ssh root@cpsbn1
root@cpsbn1's password:
$ ps ax -o pid,args | grep nanny | grep -v grep | cut -d ' ' -f -7
27213 /usr/sbin/nanny -c -h 155.157.61.161 -p 9581
27214 /usr/sbin/nanny -c -h 155.157.61.162 -p 9581
$ top -p 27213, 27214
(Typical top output is shown below, press q to quit top.)
```

```
mfegan@dev07:~
File Edit View Terminal Tabs Help
top - 20:28:19 up 133 days, 23:27, 2 users, load average: 0.10, 0.11, 0.21
Tasks: 2 total, 0 running, 2 sleeping, 0 stopped, 0 zombie
Cpu(s): 0.0%us, 0.1%sy, 0.0%ni, 98.1%id, 1.8%wa, 0.0%hi, 0.0%si, 0.0%st
Mem: 4145316k total, 2763204k used, 1382112k free, 373848k buffers
Swap: 2047992k total, 268k used, 2047724k free, 1808252k cached

  PID USER      PR  NI  VIRT  RES  SHR  S  %CPU  %MEM    TIME+  COMMAND
 27213 root        15   0 1856  672  528  S   0.0   0.0   0:17.86  nanny
 27214 root        15   0 1852  668  528  S   0.0   0.0   0:16.51  nanny
```

Exhibit 25.8.4-5. Top Output Monitoring nanny

**Example 25.8.4-4: Monitoring IPVS Using the *ipvsadm* Tool**

*ipvsadm* is the Linux Virtual Server tool. It is used by *lvsd* to assist in managing the virtual servers in a cluster. *ipvsadm* is an extremely powerful tool and must be used with care; it is available only by the root user.

That said, *ipvsadm* does include some options that provide useful diagnostic information.

- *ipvsadm -L [-t <service>]* lists the Virtual Server Table, optionally for the specified service.
- *ipvsadm -L -c* lists current connection output including client system, virtual host and destination.
- *ipvsadm -L -stats* displays the statistics information of services and their servers.
- *ipvsadm -L -rate* displays the rate information of services and their servers (use *-n* to get numeric output of servers/services).

**CAUTION:** Use extreme care when using *ipvsadm*; several of the options available in *ipvsadm* perform modifications on the IPVS Virtual Server Table. Modifying the Virtual Server Table may have an adverse impact on system operation.

The IP aliasing information used by IPVS is contained in the Virtual Server Table. The Virtual Server Table identifies the aliased server and the real servers available via that alias. It also identifies the weighting scheme used for distributing the requests between the servers and connection information. *ipvsadm* is the tool used to display and manipulate the Virtual Server Table.

To display Virtual Server Table for IPVS:

```
$ ssh root@cpsbn1
root@cpsbn1's password:
$ ipvsadm -L
IP Virtual Server version 1.2.1 (size=4096)
Prot LocalAddress:Port Scheduler Flags
  -> RemoteAddress:Port          Forward Weight ActiveConn
InActConn
TCP  edexcluster-tbdw:9581 lc
  -> dx4-tbdw:9581                Route 2      2      29
  -> dx3-tbdw:9581                Route 1  2      29  $
```

In this display, captured on a typical AWIPS II installation, we see that there are two servers, DX3 and DX4. The connection port for all three servers is 9581. The weighting scheme for the two servers is 2:1 in favor of DX4. This means that, when both servers are available to handle requests, DX4 will get a new request.

**TIP:** To see a more dynamic view of the Virtual Server Table, use the Linux *watch* command to run *ipvsadm -L*.

As shown here, *ipvsadm* defaults to showing server information using DNS names; to display IP addresses, add an “-n” flag to the *ipvsadm* command.

```
$ ssh root@cpsbn1
root@cpsbn1's password:
$ ipvsadm -L -n
IP Virtual Server version 1.2.1 (size=4096)
Prot LocalAddress:Port Scheduler Flags
  -> RemoteAddress:Port      Forward Weight ActiveConn InActConn
TCP  155.157.61.165:9581 lc
  -> 155.157.61.162:9581      Route    2         0         0
  -> 155.157.61.161:9581      Route    1         0         0
$
```

**NOTE:** The same display, showing the IP addresses of the servers, is available via service *ipvsadm* status; either form may be used. In both cases, you must be logged on as the root user to run the command.

The *ipvsadm* tool can be used to display a snapshot of the connection information between clients and servers. The command to use is *ipvsadm -L -c*; when used with the *watch* command, this provides a near real-time tracking of server routing, as shown in Exhibit 25.8.4-6.

```
IPVS connection entries
pro expire state      source                virtual
destination
TCP 10:26 ESTABLISHED xt5-tbw3:57414        edexcluster-tbw3:9581 dx4-
tbw3:9581
TCP 10:26 ESTABLISHED xt3-tbw3:42347        edexcluster-tbw3:9581 dx4-
tbw3:9581
```

**Exhibit 25.8.4-6. Monitoring IPVS Connections Using *watch***

To display the IPVS connection information in near real-time:

```
$ ssh root@cpsbn1
root@cpsbn1's password:
$ watch ipvsadm -L -c
```

(Typical output is displayed below; use <Ctrl-C> to terminate) In this display, which was captured on an AWIPS II installation, we see that three clients (lx2, lx4, and px1) are connected to DX3 (dx3-tbdw) and DX4 (dx4-tbdw) via the edexcluster-tbdw:9581.

The *ipvsadm* tool can be used to display statistics about the virtual server, including connections and packet and byte statistics, as shown in Exhibit 25.8.4-7. The command to use is *ipvsadm -L --stats* (note the double dash). As is the case with other *ipvsadm* options, *watch* can be used to provide a near real-time view of the system performance.

```

root@px1-oma:~
File Edit View Terminal Tabs Help
Every 2.0s: ipvsadm -L --stats Thu Aug 19 21:44:32 2010

IP Virtual Server version 1.2.1 (size=4096)
Prot LocalAddress:Port          Conns   InPkts  OutPkts  InBytes  OutBytes
-> RemoteAddress:Port
TCP  ts1-oma:9581                   4606   16739052      0    5697M      0
-> dx3-oma:9581                   21     45762      0 25992601      0
-> dx4-oma:9581                   24     49653      0 29702850      0

```

**Exhibit 25.8.4-7. Monitoring IPVS Connection Statistics Using watch**

To display IPVS connection statistics in near real-time:

```

$ ssh root@cpsbn1
root@cpsbn1's password:
$ watch ipvsadm -L --stats
(Typical output is displayed below; use <Ctrl-C> to terminate)

```

In this display, which was captured on a typical AWIPS II installation, we see that the two servers, DX3 (dx3-oma) and DX4 (dx4-oma), are carrying a roughly equal load of connections, packets, and bytes. The actual percentages are:

Server	Connections	Packets	Bytes
DX3	47%	48%	47%
DX4	53%	52%	53%

**NOTE:** IPVS is not handling outbound traffic so the zeros for OutPkts and OutBytes are normal.

To display IPVS rate statistics in near-real time:

```

$ ssh root@cpsbn1
root@cpsbn1's password:
$ watch ipvsadm -L --rate
(Typical output is displayed below; use <Ctrl-C> to terminate)

```

The results are displayed in Exhibit 25.8.4-8.

```

root@px1-oma:~
File Edit View Terminal Tabs Help
Every 2.0s: ipvsadm -L --rate                               Fri Aug 20 17:47:39 2010
IP Virtual Server version 1.2.1 (size=4096)
Prot LocalAddress:Port          CPS   InPPS  OutPPS  InBPS  OutBPS
-> RemoteAddress:Port
TCP  ts1-oma:9581                   0     106    0       7511   0
-> dx4-oma:9581                   0     60    0       4032   0
-> dx3-oma:9581                   0     46    0       3479   0

```

**Exhibit 25.8.4-8. Monitoring IPVS Rate Statistics Using *watch***

In this display, captured on a typical AWIPS II installation, we see that the two servers, DX3 (dx3-oma) and DX4 (dx4-oma), are handling client requests. DX4 is averaging 60 packets per second (inbound) and 3,479 bytes per second (inbound).

**NOTE:** IPVS is not handling outbound, so the zeros for OutPPS and OutBPS are normal. Connections per second (CPS) also tends to be 0 because CAVE requests are generally infrequent.

### 25.8.5 Monitoring the LDM

The Local Data Management (LDM) is the system used by AWIPS II to transfer data from the SBN to the EDEX ingest processes. (See section 25.3, [Basic Data Flow Concepts](#).) The LDM is covered extensively in other documents; this section presents basic recipes for monitoring the LDM.

There is only one LDM server on SBN CP. It ingests everything from the SBN. The LDM behavior is controlled by the `pqact.conf` file. The patterns are matched against `pqact.conf`. LDM writes the product to `data_store` and posts a QPID message.

The LDM system includes *ldmadmin*, a general administration tool used to start and stop the LDM; it also provides some of the monitoring capabilities used in these examples.

#### **Example 25.8.5-1: Verifying LDM Operation on the CP Cluster**

Although *ldmadmin* provides a tool for determining if the LDM is running, it can be easier to use the Linux *ps* utility to verify operation on the CP cluster.

##### **Scenario 1: Verify LDM Operation Using the Linux *ps* Utility**

```

$ ssh ldm@cpsbn1f
ldm@cpsbn1f's password:
$ ps -u ldm -o user,pid,args

```

USER	PID	COMMAND
ldm	30195	ldmd -I 0.0.0.0 -P 388 -M 256 -m 3600 -o 3600 -q /usr/local/ldm/v
ldm	30197	pqact -e
ldm	30198	edexBridge -s cp1f
ldm	30195	ldmd -I 0.0.0.0 -P 388 -M 256 -m 3600 -o 3600 -q /usr/local/ldm/v
ldm	30197	pqact -e
ldm	30198	edexBridge -s cp1f

The exact output will vary. Note, however, that the critical lines are those with arguments *rpc.ldmd*, *pqact*, and *edexBridge*. These indicate that the various parts of the LDM are operating.

### **Scenario 2: Verify LDM Using the *ldmadmin* Program**

The *ldmadmin* program's *isrunning* option checks to see if the LDM is running. Unfortunately, this option simply returns 0 or 1 and exits; 0 is returned if the LDM is running, and a 1 is returned if it is not running. After executing *ldmadmin isrunning*, you need to check its return value. This sequence should work under most shells:

```
$ ssh ldm@cpsbn1f
ldm@cpsbn1f's password:
$ ldmadmin isrunning
$ echo $?
0
$
```

This output indicates that the LDM is running. If it were not running, the *echo* *\$?* command would print a 1.

If you are using the *bash* shell, you can combine things slightly and produce a more readable result. The modified command sequence:

```
$ ssh ldm@cpsbn1f
ldm@cpsbn1f's password:
$ ldmadmin isrunning > /dev/null 2>&1 && echo "Running"
Running
$
```

Once again, this output indicates that the LDM is running; if it were not, no output would be displayed.

### **Example 25.8.5-2: Monitoring LDM Data Flow on the CP Cluster**

The *ldmadmin* program provides for real-time monitoring of the LDM product queue. This can be used to determine quickly if data is passing through the LDM; it can also be filtered by data feed to concentrate on a specific data type. Three scenarios are presented: 1) basic product queue monitoring; 2) identifying data feeds; and 3) monitoring a specific data feed.

### **Scenario 1: Basic Product Queue Monitoring**

The *ldmadmin* program's *watch* option provides a real-time view of the LDM's message queue. Monitoring this queue provides a quick verification of the status of the LDM. The basic steps to follow:

```
$ ssh ldm@cpsbn1f
ldm@cpsbn1f's password:
$ ldmadmin watch
(type ^D when finished)
```

At this point, you should see output similar to

```
Apr 22 21:51:11 pqutil INFO:      5160 20120422215109.997 NEXRAD3
149811050  SDUS53 KLOT 222141 /pDVLLLOT !nids/

Apr 22 21:51:11 pqutil INFO:      1011 20120422215109.997 NEXRAD3
149811051  SDUS53 KILX 222142 /pDPAILX

Apr 22 21:51:11 pqutil INFO:       165 20120422215109.997 NEXRAD3
149811052  SDUS35 KPSR 222148 /pNMDPHX !nids/

Apr 22 21:51:11 pqutil INFO:      6764 20120422215109.997 NEXRAD3
149811053  SDUS23 KILX 222142 /pN3QILX !nids/

Apr 22 21:51:11 pqutil INFO:     18621 20120422215109.997 NEXRAD3
149811054  SDUS25 KRIW 222148 /pN3URIW !nids/

Apr 22 21:51:11 pqutil INFO:        97 20120422215110.999 IDS|DDPLUS
149811055  SPUS31 KKCI 222147

Apr 22 21:51:11 pqutil INFO:       117 20120422215110.999 IDS|DDPLUS
149811056  SAMH31 PKMJ 222200

Apr 22 21:51:11 pqutil INFO:       106 20120422215110.999 IDS|DDPLUS
149811057  SALV31 EVRA 222150

Apr 22 21:51:11 pqutil INFO:       149 20120422215110.999      HDS
149811058  NXUS62 KMFL 222150 /pGSMMLA

Apr 22 21:51:11 pqutil INFO:       134 20120422215110.999 IDS|DDPLUS
149811059  SAFA31 EKCH
```

If data is flowing, this output will scroll past fairly rapidly and the message date time stamp should be current. If no messages are scrolling, it is likely that there is an issue “upstream” from the LDM.

### **Scenario 2: Identifying LDM Data Feeds**

The *ldmadmin* program's *watch* facility has an option to filter output for a specific feed type. The basic command is *ldmadmin watch -f <feed>*. This scenario presents a method for identifying the available feeds.

The feeds used by LDM are defined in a file named *pqact.conf*, which is located in *<ldm-home>/etc*. While this file can be examined to determine the available feed

types, the process can be automated using the known structure of the file and a few basic Linux utilities. The lines defining LDM feeds have the following structure:

```
FEEDTYPE <tab> pattern <tab> action [<tab> options] [<tab> args]
```

Note that lines defining feed types start with at least one upper-case letter. This allows you to filter for the feed definitions and extract the feed names. The steps to follow:

```
$ ssh ldm@cpsbn1
ldm@cpsbn1's password:
$ cd /etc
$ grep -P "^[A-Z]+" pqact.conf | cut -f 1 > feeds.txt
$ sort feeds.txt > sorted-feeds.txt
$ uniq sorted-feeds.txt ldm-feeds.txt
$ cat ldm-feeds.txt
ANY
GPSSRC
GRID
NGRID/HDS
HDS
HRS
IDS/DDPLUS
NEXRAD2
NIMAGE
NNEXRAD
$
```

The final output is a sorted list of feed names. The list may differ somewhat depending on the exact data flow configuration for the server. Some of the feed type names are rather cryptic; common feed types are identified in Table 25.8.5-1.

**Table 25.8.5-1. Selected LDM Feed Types**

Feed Name	Description
ANY	wildcard – matches any feed type
GRID	NOAAport high-resolution model output
NEXRAD2	NEXRAD Level-II radar data
NIMAGE	NOAAport satellite imagery
NNEXRAD	NEXRAD Level-III products

### ***Scenario 3: Monitoring the Radar Data Feed***

The feed type names determined in Scenario 3 may be used to filter the output of the *ldmadmin* program's *watch* facility. For level III radar, the feed type name is *NNEXRAD*. The basic procedure:

```
$ ssh ldm@cpsbn1f
ldm@cpsbn1f's password:
$ ldmadmin watch -f NNEXRAD
```



(type ^D when finished)

At this point you should see output similar to

```

May 27 19:03:51 pqutil INFO:      66695 20140527190351.324 NEXRAD3
69451329 SDUS82 KFFC 271902 /pNAXFFC !nids/

May 27 19:03:51 pqutil INFO:      1050 20140527190351.324 NEXRAD3
69451330 SDUS74 KOHX 271858 /pNETOHX

May 27 19:03:51 pqutil INFO:      17046 20140527190351.326 NEXRAD3
69451331 SDUS82 KFFC 271902 /pNAHFFC !nids/

May 27 19:03:51 pqutil INFO:      2867 20140527190351.326 NEXRAD3
69451332 SDUS74 KEWX 271858 /pEETDFX !nids/

May 27 19:03:51 pqutil INFO:      15795 20140527190351.327 NEXRAD3
69451333 SDUS23 KLOT 271901 /pNBQLOT !nids/

May 27 19:03:51 pqutil INFO:      45659 20140527190351.550 NEXRAD3
69451334 SDUS88 PAFC 271900 /pDPRAHG !nids/

May 27 19:03:51 pqutil INFO:      15994 20140527190351.552 NEXRAD3
69451335 SDUS88 PAFC 271900 /pHHCABC !nids/

May 27 19:03:51 pqutil INFO:       165 20140527190351.552 NEXRAD3
69451336 SDUS31 KILN 271901 /pNMDDAY !nids/

May 27 19:03:51 pqutil INFO:      19770 20140527190351.553 NEXRAD3
69451337 SDUS81 KALY 271902 /pN0HENX !nids/

May 27 19:03:51 pqutil INFO:      30330 20140527190351.556 NEXRAD3
69451338 SDUS24 KTSA 271901 /pNBQINX !nids/

May 27 19:03:51 pqutil INFO:       998 20140527190351.556 NEXRAD3
69451339 SDUS56 KMFR 271857 /pDPAMAX

May 27 19:03:51 pqutil INFO:      21906 20140527190351.558 NEXRAD3
69451340 SDUS24 KFWD 271902 /pN1QFWS !nids/

May 27 19:03:51 pqutil INFO:      12653 20140527190351.559 NEXRAD3
69451341 SDUS54 KSJT 271900 /pNTPDYX

May 27 19:03:51 pqutil INFO:      8638 20140527190351.560 NEXRAD3
69451342 SDUS54 KEWX 271858 /pDVLDX !nids/

May 27 19:03:51 pqutil INFO:      2294 20140527190351.560 NEXRAD3
69451343 SDUS56 KMFR 271857 /pNTPMAX

May 27 19:03:51 pqutil INFO:      63767 20140527190351.565 NEXRAD3
69451344 SDUS82 KFFC 271902 /pNACFFC !nids/

May 27 19:03:51 pqutil INFO:      6247 20140527190351.566 NEXRAD3
69451345 SDUS73 KFSD 271903 /pN0ZFSD

```

As in scenario 1, the key is to look for recent message date/time stamps and a generally constant flow of messages. In this case, a lack of messages indicates that the specific feed is not getting any messages; if frequent products are expected, this indicates a problem “upstream” from the LDM.

**Example 25.8.5-3: Monitoring LDM Log on the CP Cluster**

The LDM writes a process message, i.e., a routing status message and errors, to a log. The *ldmadmin* program provides two facilities for checking the log – *log* and *tail*. *Log* allows the user to page through the current LDM log – similar to the Linux *more* utility. *Tail* accesses the current log in a manner similar to the Linux *tail -f* utility. The basic procedure:

```
$ ssh ldm@cpsbn1f
ldm@cpsbn1f's password:
$ ldmadmin tail
```

At this point you should see output similar to

```
Aug 13 08:28:54 cpsbn1-tbw3 rpc.ldmd[12415] NOTE: Terminating
process group

Aug 13 14:11:02 cpsbn1-tbw3 rpc.ldmd[11189] NOTE: Starting Up
(version: 6.7.1; built: May  3 2011 22:54:00)

Aug 13 14:11:02 cpsbn1-tbw3 rpc.ldmd[11189] NOTE: Using local
address 165.92.24.50:388

Aug 13 14:11:20 cpsbn1-tbw3 dx2-tbw3[11207] NOTE: Data-product with
signature 57b6643d8b6432d5cd95f8144f6ef5e6 wasn't found in product-
queue

Aug 13 14:11:20 cpsbn1-tbw3 dx2-tbw3(feed)[11207] NOTE: Starting
Up(6.7.1/6): 20120813131119.276 TS_ENDT {{ANY, ".*"}}},
SIG=57b6643d8b6432d5cd95f8144f6ef5e6, Alternate

Aug 13 14:11:20 cpsbn1-tbw3 dx2-tbw3(feed)[11207] NOTE: topo:  dx2-
tbw3 {{ANY, (.*)}}

Aug 13 14:12:21 cpsbn1-tbw3 dx2-tbw3(feed)[11207] ERROR: Couldn't
flush connection; nullproc_6() failure to dx2-tbw3: RPC: Unable to
receive; errno = Connection reset by peer

Aug 13 14:12:21 cpsbn1-tbw3 rpc.ldmd[11189] NOTE: child 11207 exited
with status 6

Aug 13 14:12:22 cpsbn1-tbw3 dx2-tbw3(feed)[11208] NOTE: Starting
Up(6.7.1/6): 20120813131221.599 TS_ENDT {{ANY, ".*"}}},
SIG=1d2785ba731e4c8d1290e3de37f11413, Primary

Aug 13 14:12:22 cpsbn1-tbw3 dx2-tbw3(feed)[11208] NOTE: topo:  dx2-
tbw3 {{ANY, (.*)}}}
```

What will be displayed depends on what has been logged. In this case, you will need to enter <ctrl-c> to terminate the tail.

**25.8.6 Monitoring Radar Server**

The AWIPS II system consolidated several legacy AWIPS I radar communication and management processes into a new application called “RadarServer.” The Radar Server

(RCM) is an independent application that runs on the DX1/2 cluster. It provides a bridge between the Open Radar Products Generator (ORPG) and the EDEX Ingest processes.

Like EDEX, RCM is written in Java. As a result, most monitoring of RCM is similar to the techniques used to monitor the EDEX processes: basic Linux tools and JConsole.

**NOTE:** Radar data comes from two sources: 1) the SBN for nationally distributed data; and 2) the Radar Server for locally collected radar data, including routine data and one-time as well as multiple requests from network radars.

### **Example 25.8.6-1: Verifying Radar Server Operation**

Unlike EDEX, the startup script for RCM does not include a status check option. Rather, the Linux *ps* utility is used to verify RCM execution. The basic procedure:

```
$ ssh awips@dx1
awips@dx1's password:
$ ps ax -o args | grep rcm.mqsrvr | grep -v grep
/awips2/bin/java -cp
/awips2/rcm/data/config/res::/awips2/lib/activation-1.1.jar
(several lines of output have been deleted)
$
```

From this output, we can see that RCM is currently executing. If the Radar Server is not running, there will be no output.

**NOTE:** Recall that all Java programs show the Java VM as the first argument. The first *grep* is used to identify the Radar Server. The second *grep* filters out the first *grep* from the output.

**TIP:** Output can be simplified somewhat by piping the second *grep* into *wc -l*; in that case, the output should be 0 or 1: 0 if Radar Server is running; 1 otherwise.

If it is desirable to also identify the PID of the Java instance running RCM, add it to the output list in the *ps* call. With that modification, the procedure becomes:

```
$ ssh awips@dx1
awips@dx1's password:
$ ps ax -o pid,args | grep rcm.mqsrvr | grep -v grep
17883 /awips2/bin/java -cp
/awips2/rcm/data/config/res::/awips2/lib/activation-1.1.jar
(several lines of output have been deleted)
$
```

### **Example 25.8.6-2: Monitoring RCM Performance Using top**

As with the EDEX processes, the Linux *top* utility may be used to monitor RCM. (See [Example 25.8.6-3](#) for additional details.) The basic procedure:

```
$ ssh awips@dx1
```

```
awips@dx1's password:
$ ps ax -o pid,args | grep rcm.mqsrvr | grep -v grep
17883 /awips2/bin/java -cp
/awips2/rcm/data/config/res::/awips2/lib/activation-1.1.jar
(several lines of output have been deleted)
$ top -p 17883
```

To exit *top*, press either *q* or *<ctrl-c>*. Typical output is shown in Exhibit 25.8.6-1.

```
mfegan@dev07:/common/mfegan
File Edit View Terminal Tabs Help
top - 16:12:37 up 20 days, 2:23, 10 users, load average: 4.48, 6.50, 5.94
Tasks: 1 total, 0 running, 1 sleeping, 0 stopped, 0 zombie
Cpu(s): 35.7%us, 1.3%sy, 0.0%ni, 62.3%id, 0.6%wa, 0.0%hi, 0.1%si, 0.0%st
Mem: 4149724k total, 3974308k used, 175416k free, 5384k buffers
Swap: 2031608k total, 588868k used, 1442740k free, 321764k cached

  PID USER      PR  NI  VIRT  RES  SHR  S  %CPU  %MEM    TIME+  COMMAND
 17883 awips    22   0 1189m 101m 7836  S   0.3   2.5   5:48.38 java
```

**Exhibit 25.8.6-1. Using *top* to Monitor the Radar Server**

**What's it mean?** Even with a reasonably full flow of ORPG products, CPU usage for RCM is normally low, typically no more than 1–2 percent; usage above that value should be investigated further.

### **Example 25.8.6-3: Monitoring RCM Using JConsole**

Like EDEX, the Radar Server is a Java program; thus, JConsole may be used to monitor the Radar Server. The techniques are essentially the same as those used for monitoring EDEX. (See [Example 25.7.2-1](#), [Example 25.7.2-2](#), and [Example 25.7.2-3](#) for more details on using JConsole.) This recipe covers the steps required to connect JConsole to the Radar Server. The basic steps follow, and Exhibit 25.8.6-2 displays the results.

```
$ ssh -X awips@dx1
awips@dx1's password:
$ ps ax -o pid,args | grep rcm.mqsrvr | grep -v grep
17883 /awips2/bin/java -cp
/awips2/rcm/data/config/res::/awips2/lib/activation-1.1.jar
(several lines of output have been deleted)
$ /awips2/java/bin/jconsole 2823 &
[1]28181
$
```

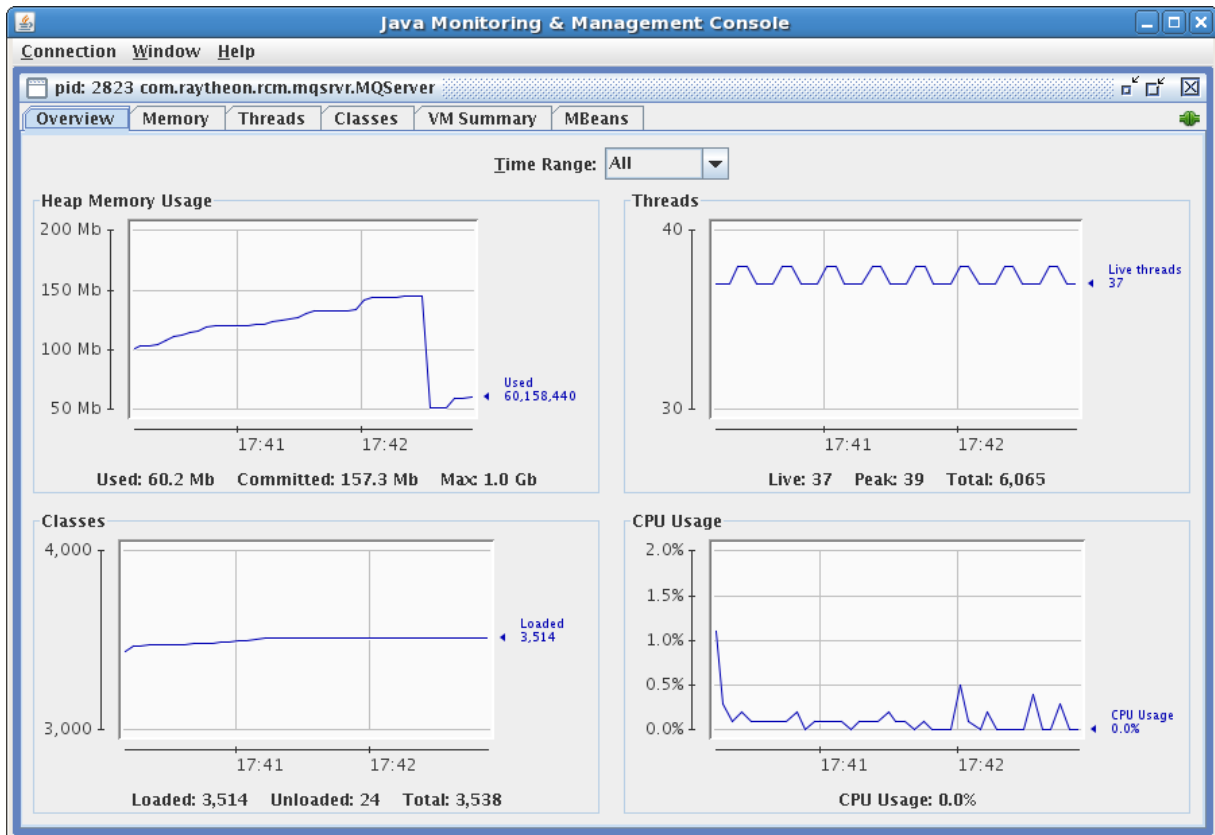

**Exhibit 25.8.6-2. Using JConsole to Monitor Radar Server**

**NOTE:** Radar Server does not support certain connectivity options of JConsole. As a result, only local connections to Radar Server are supported. In this context, “local” means logged onto the server as the user, normally `awips`, running Radar Server. This also means that we must first identify the PID of the Radar Server in order to monitor it. Once that is done, we can pass the PID to JConsole on the command line.

#### **Example 25.8.6-4: Monitoring the Radar Server Log**

Like the EDEX Processes, the Radar Server logs important events to a process log. The process logs are located on the DX 1/2 cluster in `/RadarServer/data/logs`. The Radar Server maintains a rolling set of logs; a new log is created daily. The current log is named `radarserver.log`; previous logs have the date of log appended. For example, the log for May 31, 2010 will have the name `radarserver.log.2010-05-31`.

The basic format of the entries in the Radar Server log is the same as those in the EDEX server logs; see section 25.6.4, [Log Formats](#) for more information on the EDEX log message formatting.

As with EDEX Process logs, the basic tools for monitoring Radar Server logs are `tail` and `grep`. This recipe presents two scenarios: 1) general log monitoring; and 2) filtered log monitoring.

### ***Scenario 1: Monitoring Radar Server Execution***

This scenario uses the Linux *tail* utility to provide a real-time view of events the Radar Server logs to its process log. Specific output is not displayed.

```
$ ssh -X awips@dx1
awips@dx1's password:
$ cd /awips2/rcm/data/logs
$ tail -f radarserver.log
INFO 00:00:45,912 [TCM Read kakq #2] RadarServer: kakq: message code=94
size=26632 elev=4.0 sequence=46 vs=2014-10-25 23:57:17 #48

INFO 00:00:45,934 [TCM Read kakq #2] RadarServer: Stored message in
/data_store/radar/kakq/Z/elev4_3/res1/level256/kakq.94.20141025_2357

INFO 00:00:46,257 [TCM Read kakq #2] RadarServer: kakq: message code=99
size=68264 elev=4.0 sequence=60 vs=2014-10-25 23:57:17 #48

INFO 00:00:46,334 [TCM Read kakq #2] RadarServer: Stored message in
/data_store/radar/kakq/V/elev4_3/res0_25/level256/kakq.99.20141025_2357

INFO 00:00:46,890 [TCM Read kakq #2] RadarServer: kakq: message code=149
size=7705 elev=4.0 sequence=83 vs=2014-10-25 23:57:17 #48

INFO 00:00:46,903 [TCM Read kakq #2] RadarServer: Stored message in
/data_store/radar/kakq/DMD/elev4_3/kakq.149.20141025_2357

INFO 00:00:46,934 [TCM Read kakq #2] RadarServer: kakq: message code=143
size=1558 elev=4.0 sequence=84 vs=2014-10-25 23:57:17 #48

INFO 00:00:46,947 [TCM Read kakq #2] RadarServe
```

To stop monitoring, press <ctrl-c>.

**What to look for:** Generally, you will see several messages display per minute, most of them *INFO* messages. The message frequency depends on the number of ORPG connections and the operational mode of the radars, including the RPS list employed.

### ***Scenario 2: Monitoring for Radar Product Delivery***

When the Radar Server writes a file to disk and sends a message to EDEX (via QPID), it logs a message giving the location of the file. The format of this message is:

```
INFO <time> [thread] RadarServer: Stored message in <path>
```

We use this information to filter the output of *tail* to display only the “stored message” lines from the Radar Server log. The basic steps:

```
$ ssh -X awips@dx1
awips@dx1's password:
$ cd /awips2/rcm/data/logs
$ tail -f radarserver.log | grep -P "^INFO.+Stored message"
(the display scrolls to display the latest messages as the Radar
Server writes the messages to the log file)
```

To stop monitoring, press <ctrl-c>.

**What to look for:** Generally, you should expect to see several messages per minute being logged. If the logging stops for an extended period of time, there is a problem with the ingest path.

### 25.8.7 Monitoring EDEX Subscription Script Running

The EDEX Subscription Script Runner provides a mechanism for executing arbitrary scripts based on system-level events. Three event types are supported: Quartz timer-based events; general data arrival-based events; and text product arrival-based events. (For text products, the Script Runner functions similarly to the existing text database watch/warn triggers.)

The Script Runner supports three types of script execution: text data triggered (ldad) scripts; generic (system) scripts; and  $\mu$ Engine (python) scripts. Text data triggered scripts are programs that reside on the server and, when triggered, are passed the AFOS PIL of the ingested text data. Generic scripts are also programs that reside on the server. The difference is the arguments passed to the program; any appropriate arguments can be passed to a generic script. A  $\mu$ Engine script is a Python script that is stored in the database. It can access the full capabilities of the EDEX  $\mu$ Engine.

The Subscription Script Runner has three components: EDEX Subscription Service; EDEX Script Runner; and the Command Line Interface (CLI) tool package. The CLI is covered in more detail elsewhere; the recipes in this section address system diagnostics.

#### *Example 25.8.7-1: Identifying Registered Subscriptions – Using psql*

EDEX Script Runner Subscriptions are stored in the *subscriptions* table in the AWIPS II database; the *subscriptions* table is in the *subscription* schema of the *metadata* database. We can use the *psql* tool to check for subscriptions. (For more information on the AWIPS II database and the *psql* tool, see [Examples 25.21-1 through 25.21-7](#).) This recipe presents four scenarios: 1) identifying available fields in the *subscription* table; 2) identifying available subscription trigger types, identifying timer-triggered subscriptions; and 4) identifying system runner subscriptions.

##### *Scenario 1: Identifying Available Fields in the Subscription Table*

This scenario provides information needed to access the subscription table in the AWIPS II database. In addition to the field names, we obtain the required connection/login information. The steps to follow:

```
$ ssh awips@dx3
awips@dx3's password:
$ cd /awips2/edex/bin
$ grep -P "^export DB" start.sh
export DB_ADDR=dx1
export DB_PORT=5432
$ psql -h dx1 -p 5432 -d metadata -U awips
Password for user awips:
metadata=# select table_name,column_name from
```

```

metadata=# information_schema.columns
metadata=# where table_name = 'subscriptions';
  table_name  | column_name
-----+-----
subscriptions | id
subscriptions | active
subscriptions | type
subscriptions | runner
subscriptions | trigger
subscriptions | script
subscriptions | filepath
subscriptions | arguments
(8 rows)

metadata=# \q
$

```

See Table 25.8.7-1 for information on the fields of the subscriptions table.

**Table 25.8.7-1. Subscriptions Table Fields**

Field	Description
Id	(bigint) Unique ID of the subscription
Active	(boolean) True if the subscription is active – i.e., will fire
Type	(char 10) Type of trigger event (timer, data, ldad) timer – event is triggered at a specific time data – event is triggered by data ingest ldad – event is triggered by text product ingest
Runner	(char 10) Type of script runner needed for the subscription python – use Python uEngine jscript – (deprecated) use JavaScript uEngine system – run the script as a separate process ldad – run the script using the text script runner
Trigger	(char 512) pattern to match to trigger the event
Script	(char 4048) script to run. Used only for <i>python</i> and <i>jscript</i> runners. Is encoded to preserve formatting for python.
Filepath	(char 512) full path to script to execute. Used only for <i>ldad</i> and <i>system</i> runners.
Arguments	(char 512) arguments to pass to the script. Used only for <i>ldad</i> and <i>system</i> runners. Optional. Special token, %TRIGGER%, specifying passing the trigger event to the script – used mainly for <i>ldad</i> runner.

### ***Scenario 2: Identifying Available Subscription Trigger Types***

The *type* field of the *subscriptions* table contains the subscript type. While valid subscription types are timer, ldad, and data, we can query the database to determine which types are currently registered. The steps to follow:

```

$ ssh awips@dx3
awips@dx3's password:

```



```
$ psql -h dx1 -p 5432 -d metadata -U awips
Password for user awips:
metadata=# select distinct type from
metadata=# subscription.subscriptions
metadata=# order by type;
type
-----
timer
(1 row)

Metadata # \q
$
```

### Scenario 3: Identifying Timer-Triggered Subscriptions

Once we know the available subscription types, we can easily query for subscriptions of a specific type. In this scenario, we query for *timer* type subscriptions. The steps to follow:

```
$ ssh awips@dx3
Awips@dx3's password:
$ psql -h dx1 -p 5432 -d metadata -U awips
Password for user awips:
metadata=# select id,active,type,runner,trigger
metadata=# from subscription.subscriptions
metadata=# where type = 'timer';
 id | active | type  | runner | trigger
-----+-----+-----+-----+-----
  3 | t      | timer | python | 0 * * * * ?
  6 | t      | timer | system | 0 0/5 * * * ?
(2 rows)

metadata=# \q
$
```

The output shows the single timer subscription that is currently registered. Because the value of the active field is *true*, this script should execute each minute. Note that we did not print out the fields that identify the script being executed. For *python* runners, the script is stored in the database as a binary encoded string and is not readable; for the other runners it may be useful to identify the file path and arguments. This can be accomplished easily using a slightly more complicated SQL query. The steps to follow:

```
$ ssh awips@dx3
awips@dx3's password:
$ psql -h dx1 -p 5432 -d metadata -U awips
Password for user awips:
metadata=# select type,runner,trigger,
```

```

metadata=# (case when char_length(script) > 1 then
metadata(# 'SCRIPT' else '' end) as script,
metadata=# filepath,arguments from
metadata=# subscription.subscriptions
metadata=# where type = 'timer';
  type | runner | trigger | script | filepath
  | arguments
-----+-----+-----+-----+-----
timer | python | 0 * * * * ? | SCRIPT |
|
timer | system | 0 0/5 * * * ? | /awips2/fxa/bin/myScript.sh | %TRIGGER%
(2 rows)

metadata=# \q
$

```

To shorten the display, the id and active fields are not included in the query. The result, as displayed in an xTerm, is shown in Exhibit 25.8.7-1.

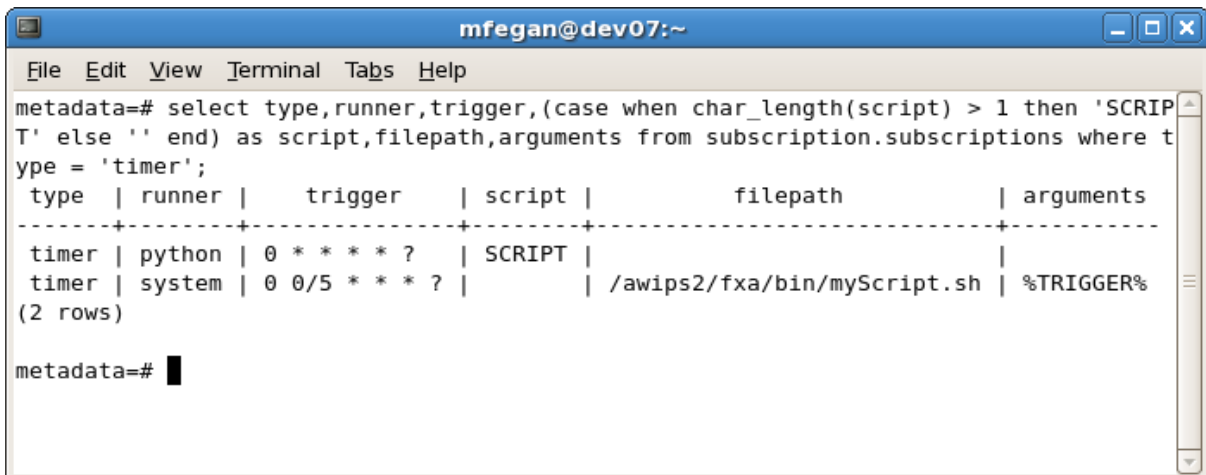

The screenshot shows a terminal window titled 'mfegan@dev07:~'. The terminal displays a SQL query and its output. The query is: `select type,runner,trigger,(case when char_length(script) > 1 then 'SCRIPT' else '' end) as script,filepath,arguments from subscription.subscriptions where type = 'timer';`. The output is a table with columns: type, runner, trigger, script, filepath, and arguments. There are two rows of data. The first row shows a timer runner 'python' with a trigger '0 \* \* \* \* ?' and script 'SCRIPT'. The second row shows a timer runner 'system' with a trigger '0 0/5 \* \* \* ?' and script '/awips2/fxa/bin/myScript.sh' with arguments '%TRIGGER%'. The terminal prompt is `metadata=#`.

Exhibit 25.8.7-1. Sample Result of Timer Type Query

**NOTE:** To see the actual script, use `decode(script,'hex')` as `script` in place of the `case` construct in the above query.

#### Scenario 4: Identifying System Runner Subscriptions

This scenario is nearly the same as Scenario 3; the main change is in the *where* clause. To identify a runner, the field to check is the *runner* field.

```

$ ssh awips@dx3
awips@dx3's password:
$ psql -h dx1 -p 5432 -d metadata -U awips
Password for user awips:
metadata=# select distinct runner from

```

```

metadata=# subscription.subscriptions
metadata=# order by runner;
runner
-----
ldad
python
system
(3 rows)

metadata # select type, runner, trigger,
metadata # (case when char_length(script) > 1 then
metadata # 'SCRIPT' else '' end) as script,
metadata # filepath,arguments from
metadata # subscription.subscriptions
metadata # where runner = 'system';
type | runner | trigger | script | filepath
| arguments
-----+-----+-----+-----+-----+-----+-----
timer | system | 0 0/5 * * * ? | | /awips2/fxa/bin/myScript.sh | %TRIGGER%
(1 row)
metadata # \q
$

```

From this output, we see that: 1) there is one *system* runner script; 2) it fires every 5 minutes; and 3) it runs *myScript.sh*, passing the value of the trigger to the script. This output is shown again in Exhibit 25.8.7-2.

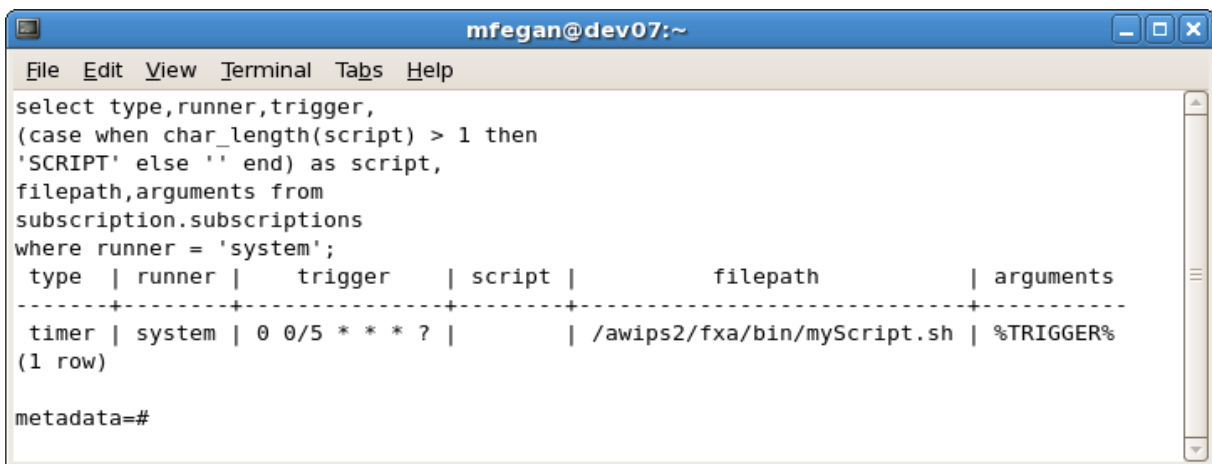

```

mfegan@dev07:~
File Edit View Terminal Tabs Help
select type,runner,trigger,
(case when char_length(script) > 1 then
'SCRIPT' else '' end) as script,
filepath,arguments from
subscription.subscriptions
where runner = 'system';
type | runner | trigger | script | filepath | arguments
-----+-----+-----+-----+-----+-----
timer | system | 0 0/5 * * * ? | | /awips2/fxa/bin/myScript.sh | %TRIGGER%
(1 row)
metadata=#

```

**Exhibit 25.8.7-2. Sample Result of System Runner Query**

### **Example 25.8.7-2: Identifying Registered Subscriptions – Using the CLI**

The Command Line Interface (CLI) tools are a set of tools that provide basic capabilities for interaction with the EDEX server. The CLI tools are normally installed on DX 3/4 in */awips2/bin*, and they are available for installation on workstations that also support

CAVE. Of interest here is the *subscription* tool, which is a custom EDEX client for managing subscriptions. This recipe introduces the *subscription* tool and provides scenarios for determining available subscriptions. As an EDEX client, it does not interact directly with the database; rather, it interacts with the EDEX server and returns specifically formatted responses. If additional information is desired, the *psql* tool can be used to interface directly with the AWIPS II database. (See [Example 25.8.7-1](#) for details.)

The *subscription* CLI tool uses a flag/value CLI for requesting information. The flags used for subscription query operations are shown in Table 25.8.7-2.

**Table 25.8.7-2. Basic Flags for Subscription CLI Tool**

Flag	Name	Description
-o	operation	Operation to perform. Valid values are <i>read</i> , <i>add</i> , <i>delete</i> , and <i>update</i> .
-p	trigger	The specific trigger for the subscription.
-t	type	The type of subscription trigger. Valid values are <i>timer</i> , <i>data</i> , and <i>ldad</i> .
-r	runner	The type of script runner for the subscription. Valid values are <i>python</i> , <i>jscrip</i> , <i>system</i> , and <i>ldad</i> , although <i>jscrip</i> is deprecated and should not be used.

For querying subscription information, the operation to use is *read*.

**NOTE:** The *subscription* tool uses a standard output format for output; the values of the *id*, *active*, *type*, *runner*, and *trigger* fields are displayed. The script is also displayed: for *python* runners, the hex encoded script is displayed; for *system* and *ldad* runners, the script's path and arguments are displayed.

### Scenario 1: Identifying Timer-Triggered Subscriptions

To determine the subscriptions of a specific trigger type, *timer* in this case, we use the *-t* with the appropriate subscription type name. The basic steps to follow:

```
$ ssh awips@dx3
awips@dx3's password:
$ cd /awips2/bin
$ ./subscription -o read -t timer
ID      ACTIVE TYPE  RUNNER TRIGGER  SCRIPT
-----
      3 True   timer python 0 * * * * ?
696d706f72742048656c6c6f576f726c640a72756e6e6572203d2048656c6c6f576f
726c642e48656c6c6f576f726c6428290a72756e6e65722e7365744d657373616765
2822222220254d4553534147452520222222290a72657475726e2072756e6e65722e
657865637574652829
      6 True   timer system 0 0/5 * * * ? /awips2/fxa/bin/myScript.sh
%TRIGGER%
$
```

It is possible to filter this output to eliminate much of the HEX output. The trick is to use the Linux *cut* tool and specify the number of characters to retain. For example, to filter output and retain just the first 80 characters of each line, “pipe” the command output into *cut -b -80*. With this refinement, the command sequence becomes

```

$ ssh awips@dx3
awips@dx3's password:
$ cd /awips2/bin
$ ./subscription -o read -t timer | cut -b -80
ID      ACTIVE TYPE  RUNNER TRIGGER  SCRIPT
-----
      3 True   timer python 0 * * * * ?
696d706f72742048656c6c6f576f726c640a72756
      6 True   timer system 0 0/5 * * * ? /awips2/fxa/bin/myScript.sh
%TRIGGER%
$

```

In either case, there are two *timer*-triggered scripts. The first one uses a stored *Python* script and triggers every minute. The second one runs *myScript.sh* every 5 minutes.

### **Scenario 2: Identifying System Runner Subscriptions**

To identify subscriptions using a specific runner, in this case the *system* runner, use the *-r* flag with the appropriate runner name. In this case, we also use the Linux *cut* utility to limit the length of the display lines. The basic steps to follow:

```

$ ssh awips@dx3
awips@dx3's password:
$ cd /awips2/bin
$ ./subscription -o read -r system | cut -b -80
ID      ACTIVE TYPE  RUNNER TRIGGER  SCRIPT
-----
      6 True   timer system 0 0/5 * * * ? /awips2/fxa/bin/myScript.sh
%TRIGGER%
$

```

**NOTE:** In both Scenario 3 and Scenario 4, only a single selection criterion is provided. In this case, selection criteria are specified using the *-t*, *-p*, or *-r* flags. In general, multiple flags are permitted but they “anded” together. For example, *subscription -o read -t timer -r system* performs a query for subscriptions that are both *timer* triggered and use external scripts (i.e., *system* runner type). The only way to perform *or* queries is to run separate queries.

### **Example 25.8.7-3: Identifying Text DB Triggers – Using the CLI**

Text DB triggers are executed using the EDEX Script Runner Service. Registered Text DB triggers are stored in the subscription table of the AWIPS II database. The AWIPS II CLI tool set provides a modified version of the *textdb* tool. The CLI *textdb* tool is a command line tool that supports the same functionality as the AWIPS I *textdb* tool. The CLI *textdb* tool allows a user to perform routine queries of the Text DB. It is also used to manage Text DB tools. This example presents two scenarios: 1) using the CLI *subscription* tool to identify Text DB triggers; and 2) using the CLI *textdb* tool to identify Text DB triggers.

**Scenario 1: Using the CLI Subscription Tool to Identify Text DB Triggers**

To use the subscription tool to identify registered Text DB triggers, you need to know either the runner type or the trigger type used for Text DB triggers. For Text DB triggers, both the runner and the trigger type are “ldad”. We can use this information to perform the query.

The basic steps to follow:

```
$ ssh awips@dx3
awips@dx3's password:
$ cd /awips2/fxa/bin
$ ./subscription -o read -r ldad
ID      ACTIVE TYPE RUNNER TRIGGER  SCRIPT
-----
1179968075 True     ldad   ldad   STLZFPNW1
1179968076 True     ldad   ldad   SFOLSRSTO
1179968077 True     ldad   ldad   SFOCEMSTO
1179968078 True     ldad   ldad   WBCZFPLWX
1179968079 True     ldad   ldad   STLNOWEAX

$ ./subscription -o read -t ldad
PRODUCTID SCRIPT
-----
STLZFPNW1 /awips/fxa/bin/asyncPilTrigger.sh
SFOLSRSTO /awips/fxa/bin/asyncPilTrigger.sh
SFOCEMSTO /awips/fxa/bin/asyncPilTrigger.sh
WBCZFPLWX /awips/fxa/bin/asyncPilTrigger.sh
STLNOWEAX /awips/fxa/bin/asyncPilTrigger.sh
$
```

It is interesting that the results obtained are different. Although both queries show that there is a Text DB trigger registered for a product ID of “STLZFPNW1”, the rest of the information is radically different. The reason for this – the *subscription* tool generally uses the *textdb* tool to perform queries that it recognizes as Text DB related. A trigger type of *ldad* indicates the query is Text DB related.

**Scenario 2: Using the CLI textdb Tool to I Text DB Triggers**

In order to identify Text DB triggers using the CLI *textdb* tool, you need to know the Product ID used to register the trigger. The basic steps to follow:

```
$ ssh awips@dx3
awips@dx3's password:
$ cd /awips2/bin
$ ./textdb -ldad -r OMAADMOMA
PRODUCTID SCRIPT
-----
OMAADMOMA /awips2/fxa/bin/myScript.sh
```

```
$ ./textdb -ldad -r OMAMTROMA
PRODUCTID SCRIPT
-----
$
```

This result shows that there is a single trigger registered for Product ID “OMAADMOMA” and no triggers registered to Product ID “OMAMRTOMA.”

#### **Example 25.8.7-4: Determining if Subscriptions Are Firing from the EDEX Process Logs**

The subscription script runner is part of the EDEX Request and Ingest process (see Table 25.8.7-3). Where the script runner is located depends on the type of script runner.

**Table 25.8.7-3. Script Runners by EDEX Process**

Runner Type	EDEX Process
timer	Ingest
data	Ingest
ldad	Ingest and Request

Note that the *ldad* runner in the EDEX Request process only fires in response to a text product being inserted into the Text DB via the CLI *textdb* tool. Because of this, the main log to monitor is the EDEX Ingest process log.

Each time the subscription fires, it logs to the appropriate EDEX process log some basic information. Generally, when the subscription fires successfully, the log messages match this pattern:

```
INFO <date> <time> [thread] ScriptRunner: Executed script: runner=
<runner>, script= <script> <trigger>
```

The script runner may output additional log messages. When script execution fails, the log messages match this pattern:

```
ERROR <date> <time> [thread] ScriptRunner: Encountered errors
executing script: runner= <runner>, script= <script> <trigger>
```

This line will normally be followed by a Java Exception stack trace that may be used to help identify the specific problem. In addition, the script runner may output additional log messages. Note that this information may be combined into a single Perl 5 style regular expression:

```
^ERROR|INFO .+ ScriptRunner:
```

You can use this information to monitor the EDEX process log and verify subscription execution.

The basic steps to follow:

```
$ ssh awips@dx3
awips@dx3's password:
$ cd /awips2/edex/logs
$ ls edex-*-20111023.log
```

```

edex-ingest-20111023.log
edex-ingestDat-20111023.log
edex-ingest-gen_areal_ffg-20111023.log
edex-ingest-gen_areal_qpe-20111023.log
edex-ingestGrib-20111023.log
edex-ingest-purge-20111023.log
edex-ingest-radar-20111023.log
edex-ingest-satellite-20111023.log
edex-ingest-shef-20111023.log
edex-ingest-shef-performance-20111023.log
edex-ingest-smartInit-20111023.log
edex-ingest-text-20111023.log
edex-ingest-unrecognized-files-20111023.log
edex-request-20111023.log
edex-request-productSrvRequest-20111023.log
edex-request-thriftSrv-20111023.log
edex-ingest-archive-20111023.log
edex-request-GFEPPerformance-20111023.log
edex-ingest-ohd-20111023.log
edex-request-textdbSrvRequest-20111023.log
edex-ingestDat-performance-20111023.log
edex-request-sportlma-20111023.log
edex-ingest-GFEPPerformance-20111023.log

$ tail -f edex-ingest-20111023.log | grep -P "^(ERROR|INFO .+
ScriptRunner: "

(as EDEX Ingest writes to the log file, lines identifying
successful ingest are displayed.)

```

To stop monitoring, press <ctrl-c>.

**NOTE:** The subscription script runners only log information for registered subscriptions and Text DB triggers. A lack of log entries simply indicates that no events, i.e., product arrivals, matching registered subscriptions have been received. See [Example 25.8.7](#) for information on using JConsole to monitor script running.

### **Example 25.8.7-5: Determining if Subscriptions Are Firing Using JConsole**

As discussed in [Example 25.7.2-2](#) and [Example 25.7.2-3](#), JConsole may be used to monitor internal operations and/or states in an EDEX process. This includes monitoring subscription script running. This is done by finding the appropriate Bean on JConsole's *MBeans* tab. The basic steps to follow are similar to those in either [Example 25.7.2-2](#) or [25.7.2-3](#). Briefly, these are:

1. Execute JConsole.
2. Establish a connection to the appropriate EDEX process. Use either <host-name>:1616 or <host-name>:1617.
3. Once the connection is complete, click the *MBeans* tab.
4. In the tree browser, expand the *org.apache.camel* node.
5. Under the *org.apache.camel* node, expand the *routes* node.



6. Scroll the tree browser to find the node labeled `<host-name>/script-runner-camel`.
7. Expand this node.
8. At this point, you will see the available script runner beans. In the EDEX Request process, only a single bean is available – “ldadWatchWarnDirect”. In the Ingest process, there are three beans – dataArrival, ldadWatchWarn, and runnerScheduled.
9. Expand the Bean node for the runner type you want to monitor.
10. Under the expanded Bean node, select attributes. This will produce a display similar to that shown in Exhibit 25.8.7-3.

The screenshot shows the Java Monitoring & Management Console interface. The left pane displays a tree view of the system's components, with the 'dataArrival' bean expanded under the 'script-runner-camel' node. The right pane shows the 'Attribute values' table for this bean.

Name	Value
CamelId	script-runner-camel
Description	EventDrivenConsumerRoute[Endpoint(jms-gener...
EndpointUri	jms-generic://queue:subscriptions
ExchangesCompleted	644089
ExchangesFailed	0
ExchangesTotal	644089
FirstExchangeCompletedTimestamp	Fri Jul 16 03:52:56 UTC 2010
FirstExchangeFailureTimestamp	
InflightExchanges	0
LastExchangeCompletedTimestamp	Fri Jul 16 21:12:08 UTC 2010
LastExchangeFailureTimestamp	
LastProcessingTime	0
MaxProcessingTime	2690
MeanProcessingTime	0
MinProcessingTime	0
RouteId	dataArrival
RoutePolicy	
State	Started
StatisticsEnabled	true
TotalProcessingTime	149225
Tracing	false

**Exhibit 25.8.7-3. Data Arrival Script Runner Bean Attributes**

Of the attributes listed, the most interesting are the three “Exchanges” attributes, and the “Processing Time” attributes. These are generally self-explanatory, although the units are not. The processing time attributes are given in milliseconds.

**Tip:** You can generally double click on any numeric attribute to get a real-time graphical view of that attribute.

**NOTE:** The images in this recipe were captured from a development server (awips-dev1.oma.ray.com) running the latest development build of EDEX. On a production system, the computer name will change appropriately.

### 25.8.8 Monitoring EDEX Smart Init Processing

AWIPS II uses the EDEX Ingest process to perform Smart Init processing. As such, basic information on Smart Init execution is logged to the EDEX Ingest process log.

AWIPS II Smart Init processing utilizes an aggregation strategy within EDEX; as GRIB products are ingested within EDEX, product information is forwarded to the aggregation endpoint. EDEX uses a quartz trigger that fires every minute to trigger Smart Init processing.

In the EDEX Ingest process log, Smart Init entries follow a specific general pattern:

```
<level> <date> <time> [smartInitThreadPool-#] <source>: <message>
```

This pattern may be used to filter the EDEX Ingest process log for messages generated by Smart Init.

There are two ways to monitor basic Smart Init processing: monitoring the EDEX Ingest process log; and monitoring the EDEX Ingest process using JConsole. The recipes in this section provide information on these two monitoring methods.

#### **Example 25.8.8-1: Monitoring the EDEX Ingest Process Log for Smart Init Processing**

(This recipe is similar to [Example 25.7.1-5, Monitoring Data Ingest](#).) We use the Linux *tail* tool to display the process log in real time; to isolate Smart Init processing, we use the Linux *grep* tool to filter and limit the output to Smart Init.

A Perl 5 regex that matches Smart Init log entries is:

```
^.+\[smartInit
```

The basic steps to follow:

```
$ ssh awips@dx3
awips@dx3's password:
$ cd /awips2/edex/logs
$ ls edex-20111023*.log

edex-ingest-20111023.log
edex-ingestDat-20111023.log
edex-ingest-gen_areal_ffg-20111023.log
edex-ingest-gen_areal_qpe-20111023.log
edex-ingestGrib-20111023.log
edex-ingest-purge-20111023.log
edex-ingest-radar-20111023.log
edex-ingest-satellite-20111023.log
edex-ingest-shef-20111023.log
edex-ingest-shef-performance-20111023.log
edex-ingest-smartInit-20111023.log
edex-ingest-text-20111023.log
edex-ingest-unrecognized-files-20111023.log
edex-request-20111023.log
edex-request-productSrvRequest-20111023.log
edex-request-thriftSrv-20111023.log
```

```

edex-ingest-archive-20111023.log
edex-ingest-GFEPPerformance-20111023.log
edex-ingest-activeTableChange-20111023.log
edex-ingestDat-activeTableChange-20111023.log
edex-ingestDat-performance-20111023.log
edex-ingestGrib-activeTableChange-20111023.log
edex-ingestGrib-performance-20111023.log
edex-ingest-performance-20111023.log
edex-request-activeTableChange-20111023.log
edex-request-performance-20111023.log
edex-ingest-gen_areal_qpe-20111023.log
edex-ingest-ohd-20111023.log
edex-request-textdbSrvRequest-20111023.log
edex-ingestDat-performance-20111023.log
edex-request-sportlma-20111023.log
edex-request-GFEPPerformance-20111023.log

$ tail -f edex-ingest-20111023.log | grep -P "^.+\[smartInit"

```

(As EDEX ingest writes to the log file, lines identifying Smart Init operations are displayed.)

To stop monitoring, press <ctrl-C>.

In normal operation, you should expect to see a fairly steady stream of log messages.

### **Example 25.8.8-2: Monitoring Smart Init Calculations (in the EDEX ingest process log)**

As discussed in [Example 25.7.1-5, Monitoring Data Ingest](#), the output from the Linux *tail* utility may be filtered to isolate specific types of information. As a general rule, you need to examine the log for patterns that indicate specific types of information and adjust the filter pattern accordingly. In this recipe, we need to identify the basic pattern used for logging Smart Init calculations.

A Perl 5 regex that matches Smart Init calculation lines is `^.+\[smartInit.+Calc :`

The basic steps to follow:

```

$ ssh awips@dx3
awips@dx3's password:
$ cd /awips2/edex/logs
$ ls edex-*20111023.log

```

**Note:** For this log file, for example, use `ls edex-*-20111023.log`

```

edex-ingest-20111023.log
edex-ingestDat-20111023.log
edex-ingest-gen_areal_ffg-20111023.log
edex-ingest-gen_areal_qpe-20111023.log
edex-ingestGrib-20111023.log
edex-ingest-purge-20111023.log
edex-ingest-radar-20111023.log
edex-ingest-satellite-20111023.log
edex-ingest-shef-20111023.log

```

```

edex-ingest-shef-performance-20111023.log
edex-ingest-smartInit-20111023.log
edex-ingest-text-20111023.log
edex-ingest-unrecognized-files-20111023.log
edex-request-20111023.log
edex-request-productSrvRequest-20111023.log
edex-request-thriftSrv-20111023.log
edex-ingest-archive-20111023.log
edex-ingest-GFEPPerformance-20111023.log
edex-ingest-activeTableChange-20111023.log
edex-ingestDat-activeTableChange-20111023.log
edex-ingestDat-performance-20111023.log
edex-ingestGrib-activeTableChange-20111023.log
edex-ingestGrib-performance-20111023.log
edex-ingest-performance-20111023.log
edex-request-activeTableChange-20111023.log
edex-request-performance-20111023.log
edex-ingest-gen_areal_qpe-20111023.log
edex-ingest-ohd-20111023.log
edex-request-textdbSrvRequest-20111023.log
edex-ingestDat-performance-20111023.log
edex-request-sportlma-20111023.log
edex-request-GFEPPerformance-20111023.log

$ tail -f edex-ingest-20111023.log | grep -P "^.\+[smartInit.+Calc
:"

```

(As EDEX Ingest writes to the log file, lines identifying Smart Init operations are displayed.)

To stop monitoring, press <ctrl-C>.

In normal operation, you should expect to see a fairly steady stream of log messages.

### **Example 25.8.8-3: Monitoring Smart Init Using JConsole**

To monitor Smart Init processing using JConsole, you generally need to identify two items – the name of the Camel Route and the name of the MBean (or MBeans) to monitor. (See [Example 25.7.2-1](#), [Example 25.7.2-2](#), and [Example 25.7.2-3](#) for details on connecting to EDEX and finding the correct Camel Route and MBean.)

For Smart Init, the name of the Camel Route is *<host name>/gfe-camel-spring*. This route hosts several Beans that handle Smart Init capabilities; the two that we will examine are *smartInitTrigger* and *smartInitWork*. As the names imply, *smartInitTrigger* is the trigger that fires each minute to initiate processing, while *smartInitWork* is the service that runs the Smart Init scripts.

Follow the procedure in [Example 25.7.2-1](#) to connect to the EDEX Ingest process on DX3. Once the connection is made, select the *MBeans* tab and find the *gfe-camel-spring* route in the tree explorer. Click to expand the *gfe-camel-spring* route. JConsole will look similar to [Exhibit 25.8.8-1](#).

To monitor Smart Init trigger firing, expand the *smartInitTrigger* bean and click on *Attributes*. This will display the attributes, as shown in Exhibit 25.8.8-2.

As mentioned in [Example 25.7.2-2](#) and [Example 25.7.2-3](#), the interesting attributes are the “Exchanges” and “Processing Time” attributes. Remember that times are given in milliseconds.

To monitor the Smart Init processing, expand on the *smartInitWork* Bean and click on *Attributes*. This will display the attributes, as shown in Exhibit 25.8.8-3.

As before, the interesting attributes are the “Exchanges” and “Processing Time” attributes. Remember that times are given in milliseconds.

As mentioned previously, you can usually double click on a numeric attribute in the *attribute values* display panel to get an automatically updating graph of the attribute’s value. An example of this is shown in Exhibit 25.8.8-4.

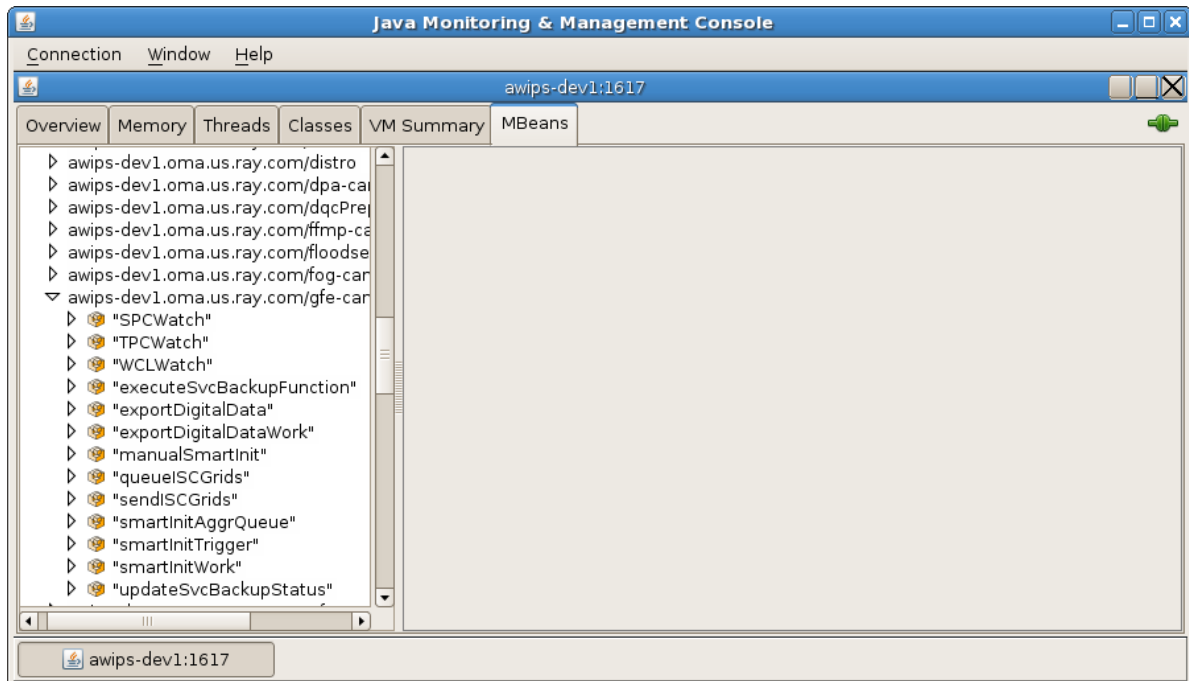

**Exhibit 25.8.8-1. gfe-camel-spring Route in JConsole**

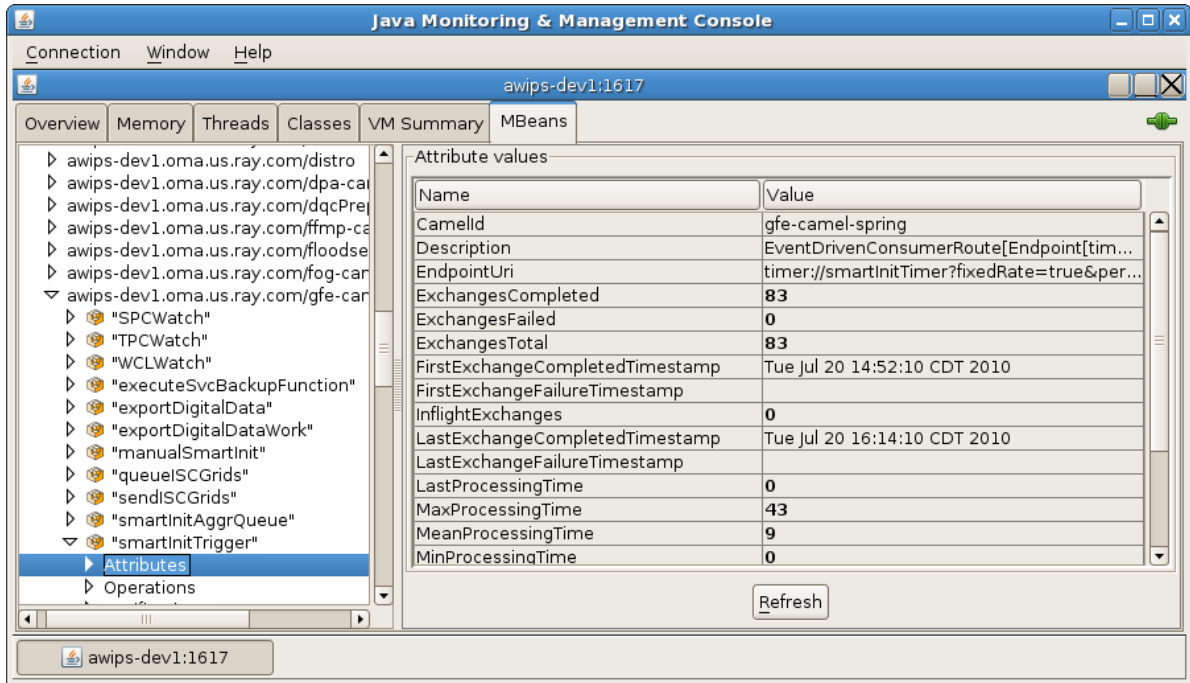

Exhibit 25.8.8-2. smartInitTrigger Bean Attributes in JConsole

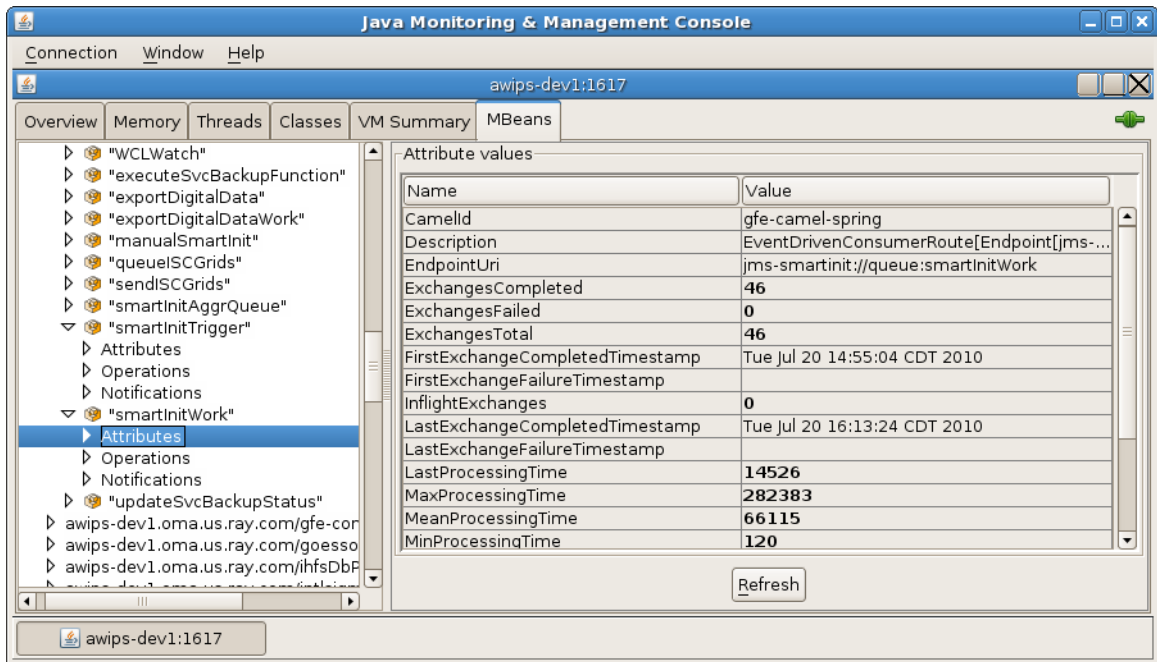
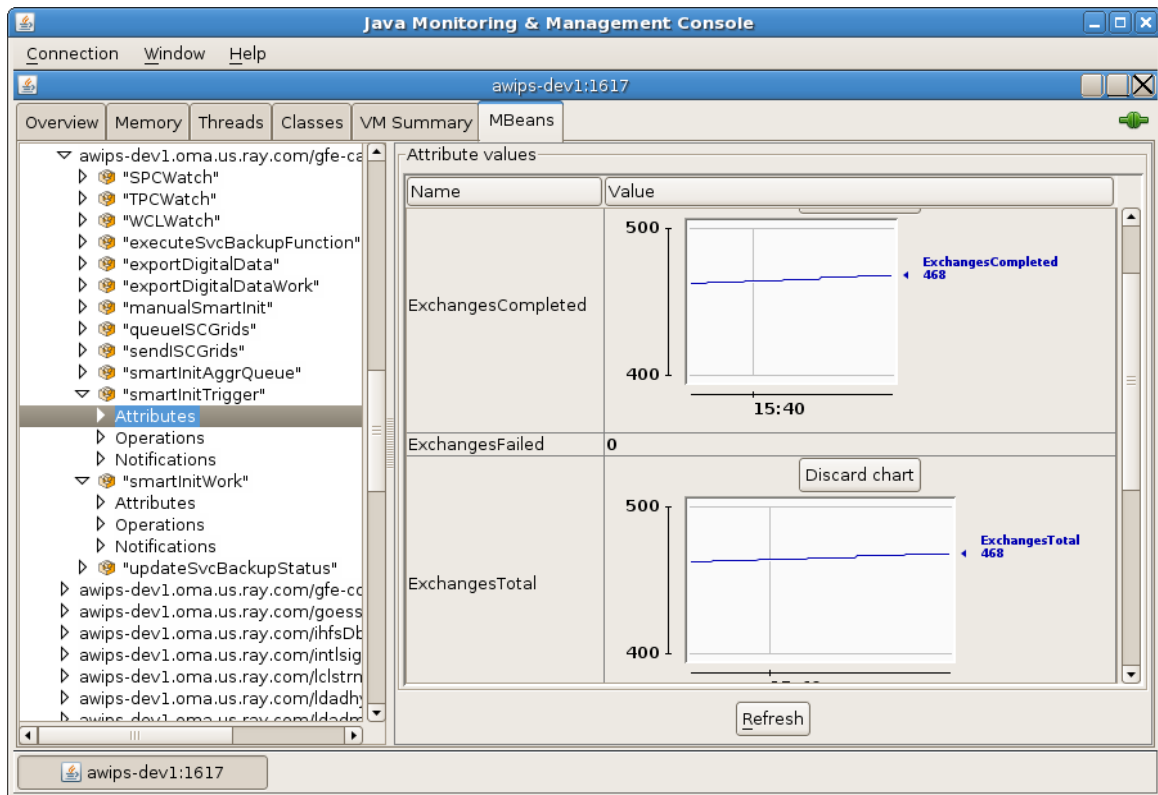

Exhibit 25.8.8-3. smartInitWork Bean Attributes in Jconsole



**Exhibit 25.8.8-4. JConsole Bean Attributes with Graphs**

For both the *smartInitTrigger* bean and the *smartInitWork* bean, the number of Exchanges Completed should match the number of Exchanges Total. Ideally, the number of Exchanges Failed should be zero.

## 25.9 HDF5 Tools

The HDF5 tool set includes tools that allow examination, export, and modification of HDF5 files. These tools are installed into /awips2/tools on the database server DX2. The tools themselves are installed in /awips2/tools/bin; the supporting libraries are in /awips2/tools/lib.

### 25.9.1 HDF5 Tools - Procedures

The general procedure for running the HDF5 tools may be summarized as follows:

1. Log onto the database server (e.g., DX2).
2. Run the tool(s).

Four of the available HDF5 tools that are installed with AWIPS II in the examples that follow. These tools identified in Table 25.9.1-1.

**Table 25.9.1-1. Useful HDF5 Tools from the HDF Group**

Tool	Description
h5ls	Lists specified features of an HDF5 file. This tool is used to determine the contents

	of the HDF5 file
h5dump	Dumps the contents of an HDF5 file in ASCII format. This tool is used to examine the actual contents of the HDF5 file.
h5stat	Reports statistics regarding an HDF5 file and the objects stored in the file.
h52gif	Converts images in an HDF5 file to a GIF image.

For all remaining examples in the this section, assume that some satellite images have been archived in an HDF5 file named `satellite-1144554058.h5`, which is located in `/tmp`.

### **Example 25.9.1-1: The *h5ls* Tool**

The *h5ls* tool produces a list of specific features in an HDF5 file. The list is written to standard out and can be redirected into a text file for viewing. The basic command to use is:

```
h5ls -r file[/OBJECT]
```

Where: *file* is the path to the HDF5 file and *OBJECT* is the path within the HDF5 file. The “-r” flag indicates a recursive listing starting with the specified path within the file.

### **Example 25.9.-2: The *h5dump* Tool**

The *h5dump* tool prints the contents of the HDF5 file to standard out in an ASCII format. The default format for the dump is the HDF Group’s HDF5 Data Description Language; it tends to be verbose. When using this tool, it is best to redirect the output into a text file and use *vi* or *less* to examine the contents. The basic *h5dump* commands to use are:

```
h5dump file
```

Where: *file* is the path to the HDF5 file, and

```
h5dump -d dataset file
```

Where: *dataset* is the name of a single dataset to dump.

The first form dumps the entire file while the second form dumps a single data object.

**NOTE:** The other options are available for *h5dump*; to see the available options, run *h5dump* without any command line arguments.

### **Example 25.9.1-3: The *h5stat* Tool**

The *h5stat* tool reports statistics on an HDF5 file and the objects (i.e., data) that are stored in the file. The statistics reported are somewhat extensive and may be filtered using various command line options. The basic *h5stat* command is:

```
H5stat file
```

Where *file* is the path to the HDF5 file.



### Example 25.9.1-4: The *h52gif* Tool

The *h52gif* tool extracts an image from an HDF5 file and converts it to a gif-formatted image. To render as an image, the object must be stored in the HDF5 file as a rectangle. To convert a rectangular object to a gif image, the basic command is:

```
h52gif h-file g-file -i image
```

Where: *h-file* is the path to the HDF5 file; *g-file* is the path to the output file; and *image* is the path to the image data in the HDF5 file

### 25.9.2 The $\mu$ Engine Web Test Driver

Built into the AWIPS II EDEX application is a web-based test driver that provides identification information on satellite, radar, GRIB, and ASCII products. The test driver may be used to help verify product data flow and to request displayable products.

The URL for the test driver is `http:<EDEX server>:8080/uEngineWeb/index.html` where `<EDEX server>` is the DNS name of the EDEX server, normally `dx3` or `dx4`.

**NOTE:** IPVS, which provides IP aliasing/load balancing for CAVE-EDEX interactions, does not currently handle web-based interactions with the EDEX server.

#### Example 25.9.2-1: Retrieving a Satellite Image via the $\mu$ Engine Web Test Driver

For this recipe, we use the  $\mu$ Engine Web test driver to access and display satellite data. The assumption used is simple: If the data can be displayed, it can be ingested. The  $\mu$ Engine Web test driver is used to allow more control over the selection of specific data than is easily available in CAVE.

- a. On a workstation with network access to the EDEX server, open a web browser and enter the  $\mu$ Engine Web's URL into the address bar. A display of the basic  $\mu$ Engine Web's test page follows.

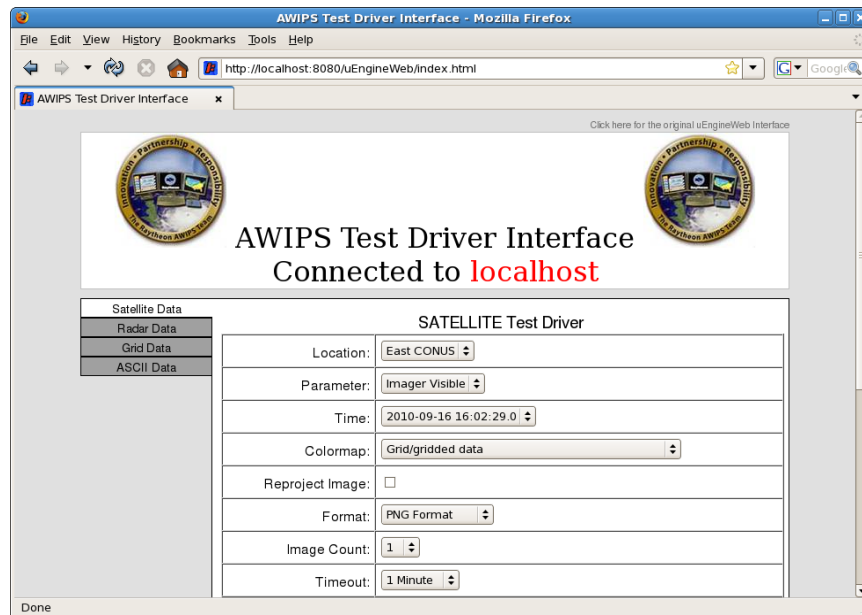

- b. On the test driver, select the location, parameter, and time from the dropdown lists.

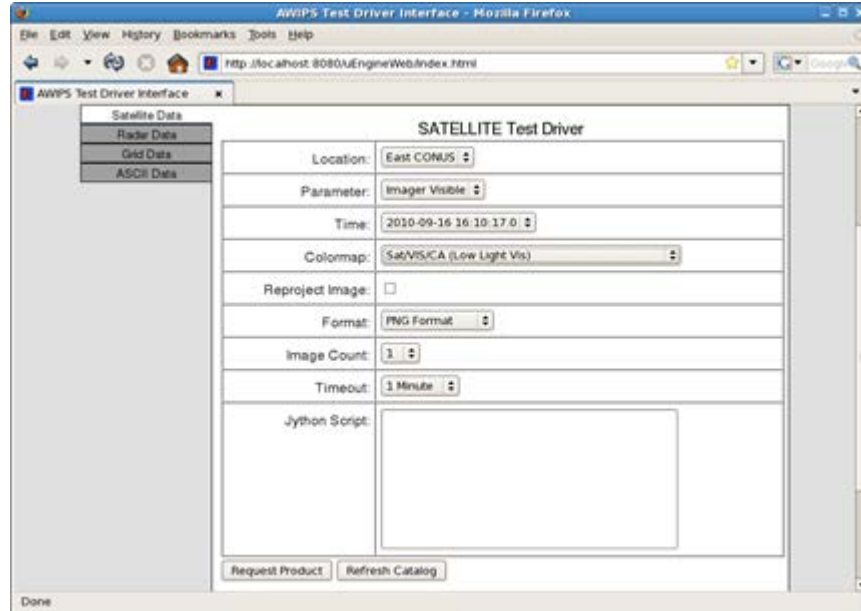

You should also select a color map that is more appropriate to satellite data.

- c. Scroll down the page and click *Request Product*. After a short pause, the image will be displayed. (You may need to scroll down to see the actual image.)

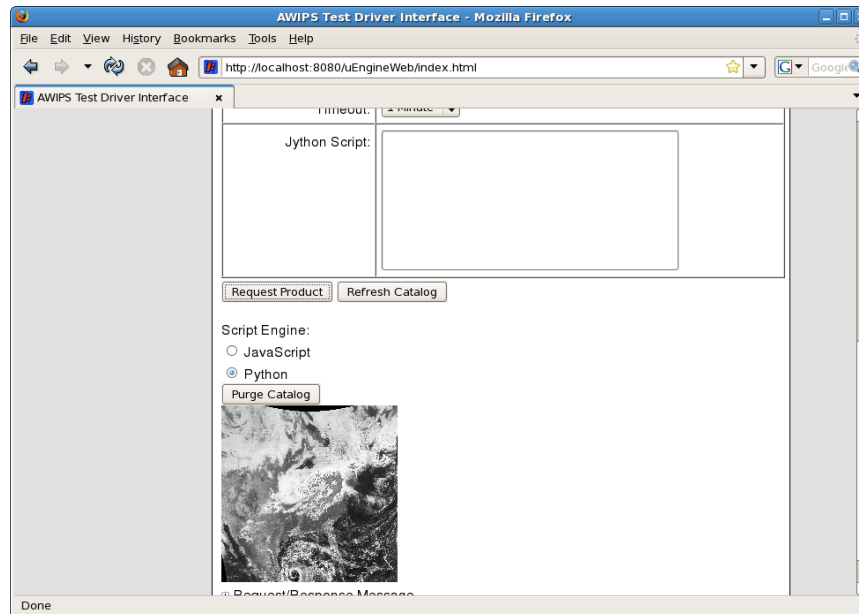

- d. Double click on the image to display a larger version; depending on the browser settings, it may display in a separate tab or in a separate browser.

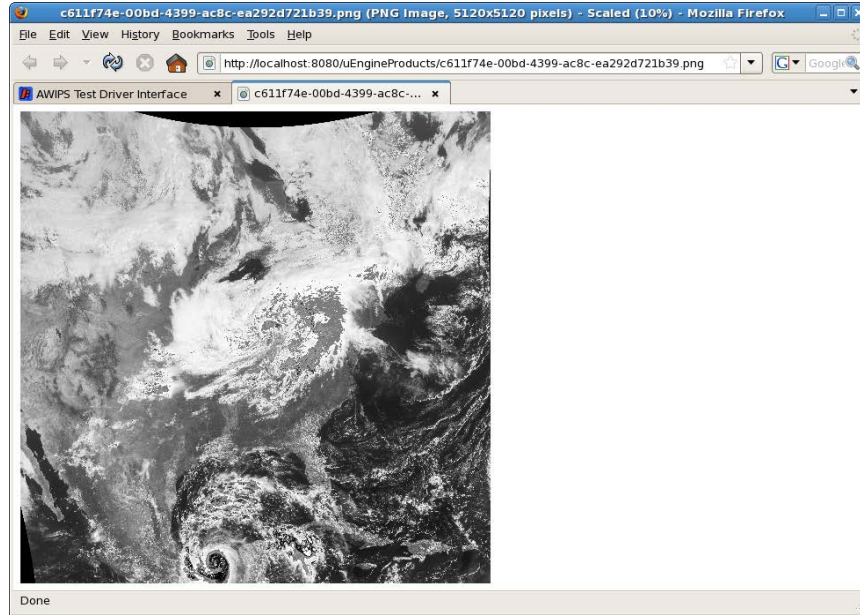

If there are any problems, a popup error dialog will be displayed.

**NOTE:** Prior to using the  $\mu$ Engine Web test page to display the data, the procedure outlined in Example 25.9.1-5 may be used to identify the data to display.

**HINT:** The  $\mu$ Engine Web test page only allows you to select data that has been ingested.

## 25.10 CAVE/Workstation Setup Considerations

Most of this appendix has been oriented toward server operation and troubleshooting. This section discusses potential problems with the main AWIPS II client application, CAVE. In AWIPS II, CAVE (Common AWIPS Visualization Environment) provides much of the functionality of D-2D, GFE, etc. in a single, integrated environment.

### 25.10.1 CAVE Startup Modes

In addition to the standard startup, CAVE has the capability to start in multiple modes: Text WS, AvnFPS Menu, AvnFPS Setup. A startup mode is activated by passing – *component switch* via the command line when starting CAVE. (See Table 25.10.1-1.)

**Table 25.10.1-1. CAVE Startup Modes**

Mode	Switch	Description
Text WS	textws	Implements Text Workstation functionality from AWIPS.
AvnFPS Menu	avnmenu	Implements the AvnFPS Menu functionality from AWIPS.
AvnFPS Setup	avnsetup	Implements the AvnFPS Setup functionality from AWIPS.

### 25.10.2 Cave Installation

CAVE is installed on both the LX and the XT workstations, and has two main components: CAVE and Alert VIZ. CAVE can be started in two modes (see section 25.10.1, [CAVE Startup Modes](#), Table 25.10.1-1). In normal operation, it is started in *standard* mode on the LX workstation, and in *textws* mode on the XT workstation.

CAVE is normally installed in `/usr/local/viz`. That installation includes CAVE, Alert VIZ, GFEClient, and support software such as Java and Python. Table 25.10.2-1 lists the expected directories under `/usr/local/viz`.

**Table 25.10.2-1. Contents of VIZ Install Directory**

Directory	Contents
alertviz	Contains the Alert VIZ application and support files.
basemaps	Contains shape files used by CAVE.
bin	Contains executables and scripts used in connection with AWIPS II VIZ software.
cave	Contains the CAVE application and support files.
caveData	Used by the installer.
fxa	Used by the installer.
gfeclient	Contains the GFE Client application.
include	Contains header files for the notification API.
java	Contains Java runtime and documentation files.
lib	Contains library files used in connection with AWIPS II VIZ software.
notification	Contains the notification API.
psql	Used by the installer.
python	Used by the installer.
setup	Used by the installer.
Uninstaller	Contains the uninstaller.

### 25.10.3 CAVE Startup

Starting CAVE depends on how the system is installed. For the recipes in this section, we assume a launcher has been created to run the CAVE startup script, `cave.sh`, with the appropriate startup mode flag. (See section 25.10.1, [CAVE Startup Modes](#).) This is also assumed for the Alert VIZ application. Note that Alert VIZ should be started prior to starting CAVE.

If a launcher is not available for CAVE, the following steps can be used to start CAVE.

In AWIPS II, there are three methods for starting CAVE:

1. Open a console window and **Enter: `/awips2/cave/cave.sh`**.
2. Open a console window and **Enter: `cd /awips2/cave/;./cave.sh`**.
3. Open a console window and **Enter: `/bin/bash -l -c /awips2/cave/cave.sh`**.

**TIP:** Both CAVE, in its various modes, and Alert VIZ write information to STDOUT and STDERR. This information may be useful for diagnosing runtime problems. Normally, this information is lost as the terminal window scrolls; it is also lost when starting either application using a launcher. It is possible to capture this information to a file for later review using Linux output redirection. To do so, add `2>&1 | tee ~/logs/<app name>.txt` to the command line. You can also add a similar redirect to the launcher.

In each of the recipes that follow, it is assumed you are logged on to the appropriate workstation and have opened a terminal window.

### **Example 25.10.3-1: Validating the LX VIZ Installation**

To validate the CAVE installation, you check to see if the software has been installed on the workstation. In addition, you will need to verify that the NFS mount is available and that the EDEX servers and companion XT workstation are accessible from the workstation. For this recipe, assume you are logged on to the LX1 workstation and have an open terminal window.

The basic steps to follow:

```
$ cd /usr/local/viz
$ ls -l

drwxr-xr-x  8 awips fxalpha 4096 Oct 30 12:58 alertviz
drwxr-xr-x 13 awips fxalpha 4096 Nov  5 16:21 cave
drwxr-xr-x  3 root  root    4096 Oct 30 13:16 edex
drwxr-xr-x  4 awips fxalpha 4096 Oct 30 12:58 fxa
drwxr-xr-x  5 awips fxalpha 4096 Oct 30 12:58 GFESuite
drwxr-xr-x  9 awips fxalpha 4096 Oct 30 12:58 java
drwxr-xr-x  7 awips fxalpha 4096 Oct 30 12:57 notification
drwxr-xr-x  4 awips fxalpha 4096 Oct 30 12:58 pgadmin3
drwxr-xr-x  4 awips fxalpha 4096 Oct 30 12:58 psql
drwxr-xr-x  8 awips fxalpha 4096 Oct 30 12:58 python

$ mount | grep -I hdf5
/dev/mapper/vg_aiihdf5-awipsiihdf5 on /awips2/edex/data/hdf5
type ext3 (rw)
```

*(The server name and local mount point may be different.)*

```
$ ping dx2
64 bytes from dx2-tbw3 (165.92.24.2): icmp_seq=2 ttl=64 time=0.167 ms
64 bytes from dx2-tbw3 (165.92.24.2): icmp_seq=3 ttl=64 time=0.167 ms
64 bytes from dx2-tbw3 (165.92.24.2): icmp_seq=4 ttl=64 time=0.177 ms
64 bytes from dx2-tbw3 (165.92.24.2): icmp_seq=5 ttl=64 time=0.164 ms
64 bytes from dx2-tbw3 (165.92.24.2): icmp_seq=6 ttl=64 time=0.176 ms
```

```
64 bytes from dx2-tbw3 (165.92.24.2): icmp_seq=7 ttl=64 time=0.160 ms
64 bytes from dx2-tbw3 (165.92.24.2): icmp_seq=8 ttl=64 time=0.168 ms
64 bytes from dx2-tbw3 (165.92.24.2): icmp_seq=9 ttl=64 time=0.167 ms
64 bytes from dx2-tbw3 (165.92.24.2): icmp_seq=10 ttl=64 time=0.171 ms
64 bytes from dx2-tbw3 (165.92.24.2): icmp_seq=11 ttl=64 time=0.166 ms
64 bytes from dx2-tbw3 (165.92.24.2): icmp_seq=12 ttl=64 time=0.168 ms
64 bytes from dx2-tbw3 (165.92.24.2): icmp_seq=13 ttl=64 time=0.173 ms
64 bytes from dx2-tbw3 (165.92.24.2): icmp_seq=14 ttl=64 time=0.177 ms
64 bytes from dx2-tbw3 (165.92.24.2): icmp_seq=15 ttl=64 time=0.169 ms
64 bytes from dx2-tbw3 (165.92.24.2): icmp_seq=16 ttl=64 time=0.165 ms
64 bytes from dx2-tbw3 (165.92.24.2): icmp_seq=17 ttl=64 time=0.151 ms
64 bytes from dx2-tbw3 (165.92.24.2): icmp_seq=18 ttl=64 time=0.171 ms
```

**What's it mean?** A correctly set up workstation box will have the directory structure and data (HDF5) mount, and will be able to ping the EDEX servers and its XT workstation successfully.

**TIP:** This check can be performed remotely by using *ssh* to log into the LX workstation.

### ***Example 25.10.3-2: Validating the XT VIZ Installation***

Validating the XT VIZ install is similar to validating the LX installation. The only difference is that the XT workstation needs to be able to access the LX. For this reason, you can follow the steps in Example 25.10.3-1, replacing *xt1* with *lx1* in the final *ping*.

### ***Example 25.10.3-3: Cave Connection Problems***

The first time a user runs CAVE or Alert VIZ (on an LX workstation) or Text WS (on an XT workstation), connection information is requested. This information points CAVE, Alert VIZ, or Text WS to the EDEX localization server. It may also point CAVE or the Text WS to Alert VIZ. This information, as well as certain user preferences, is stored in a directory structure under *caveData* in the user's home directory. Should the *caveData* directory tree be deleted, a VIZ application will request connection information the next time it is started. It does this via the dialogs shown in Exhibits 25.10.3-1 and 25.10.3-2.

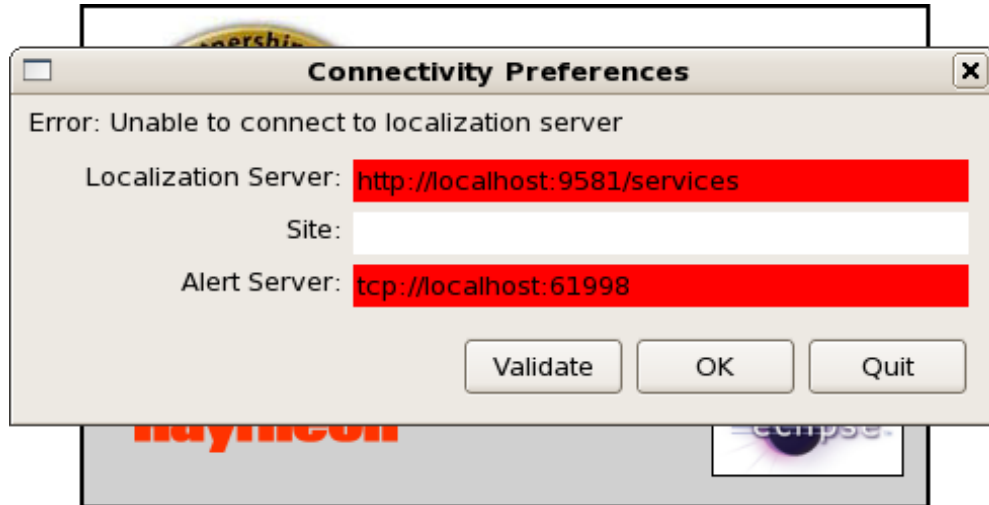

Exhibit 25.10.3-1. CAVE Connectivity Error When Alert VIZ Is Not Available

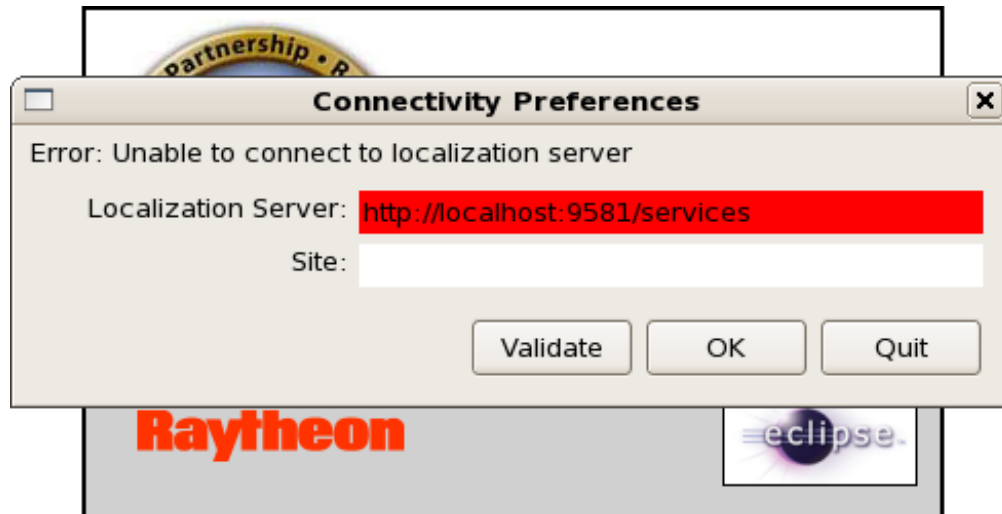
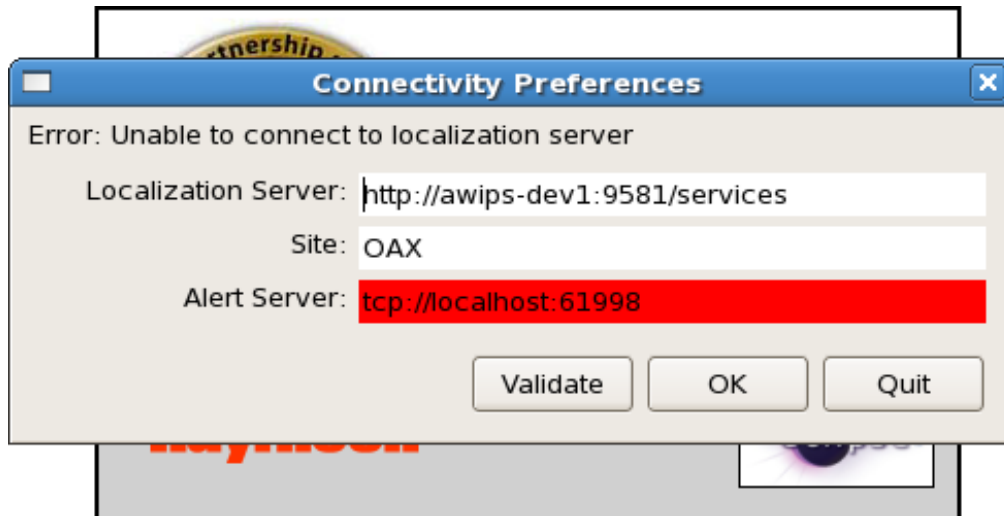

Exhibit 25.10.3-2. CAVE Connectivity Error When Alert VIZ Is Available

Recall from Section 25.10.1, [CAVE Startup Modes](#) that AlertVIZ must be started or available before starting CAVE. Exhibit 25.10.3-3 shows the startup if CAVE is unable to find Alert VIZ at startup. In this exhibit, CAVE was able to find its localization server.



**Exhibit 25.10.3-3. No Alert VIZ, Localization Available**

**NOTE:** You will also see this dialog if you attempt to start Alert VIZ on the LX workstation and the localization server is invalid.

If you see either version of this dialog when starting CAVE, Text WS or Alert VIZ, replace *localhost* with the name or IP address of the EDEX request server, enter the desired localization site, and, if the Alert Server box is displayed, replace localhost with the name or IP address of the Alert Server. Finally, click the *validate* button. If the entries are valid, the red highlights will be removed. Note that the localization site is not validated. Also note that the text (i.e., “Error: Unable to connect to localization server”) is not changed when the entries are valid; only the highlight is removed.

### 25.11 Verifying That AWIPS II Processes Are Running

This section presents alternative methods for validating operation of the EDEX processes. These may be used in place of the methods outlined earlier.

#### On DX3/4:

```
ps -ef | grep -v grep | grep edex.run.mode | cut -b -80

awips 27008 27004 99 17:12 ? 01:50:01
/awips2/java/bin/java -Dedex.run
awips 27211 27209 19 17:12 ? 00:22:01
/awips2/java/bin/java -Dedex.run
awips 27329 27323 3 17:12 ? 00:03:41
/awips2/java/bin/java -Dedex.run
awips 27434 27432 4 17:12 ? 00:05:09
/awips2/java/bin/java -Dedex.run
```



**NOTE:** There should be four lines of output, one for each of the EDEX processes: ingest, ingestDat, ingestGrib, and request. The results will be similar on both DX3 and DX4.

**On dx1f:**

```
ps -fU awips | grep -v idle | cut -d "-" -f1,2

UID          PID  PPID  C  STIME TTY          TIME CMD
awips        631  9444  1  18:14 ?            00:00:32
/awips2/httpd_pypies/usr/sbin/httpd -f
/awips2/httpd_pypies/etc/httpd/conf/httpd.conf
awips        636  9444  1  18:14 ?            00:00:36
/awips2/httpd_pypies/usr/sbin/httpd -f
/awips2/httpd_pypies/etc/httpd/conf/httpd.conf
awips        645  9444  1  18:14 ?            00:00:36
/awips2/httpd_pypies/usr/sbin/httpd -f
/awips2/httpd_pypies/etc/httpd/conf/httpd.conf
awips        6094 9444  1  18:20 ?            00:00:28
/awips2/httpd_pypies/usr/sbin/httpd -f
/awips2/httpd_pypies/etc/httpd/conf/httpd.conf
awips        6579 9444  1  18:22 ?            00:00:33
/awips2/httpd_pypies/usr/sbin/httpd -f
/awips2/httpd_pypies/etc/httpd/conf/httpd.conf
awips        6758 9444  0  18:22 ?            00:00:21
/awips2/httpd_pypies/usr/sbin/httpd -f
/awips2/httpd_pypies/etc/httpd/conf/httpd.conf
awips        8935 9444  0  18:28 ?            00:00:18
/awips2/httpd_pypies/usr/sbin/httpd -f
/awips2/httpd_pypies/etc/httpd/conf/httpd.conf
awips        8936 9444  1  18:28 ?            00:00:23
/awips2/httpd_pypies/usr/sbin/httpd -f
/awips2/httpd_pypies/etc/httpd/conf/httpd.conf
awips        8937 9444  1  18:28 ?            00:00:30
/awips2/httpd_pypies/usr/sbin/httpd -f
/awips2/httpd_pypies/etc/httpd/conf/httpd.conf
awips        8947 9444  1  18:28 ?            00:00:34
/awips2/httpd_pypies/usr/sbin/httpd -f
/awips2/httpd_pypies/etc/httpd/conf/httpd.conf
awips        9002   1  0  Oct21 ?            00:00:26
/awips2/postgresql/bin/postmaster -D /awips2/data
awips        9016  9002  0  Oct21 ?            00:00:02 postgres: logger
process
awips        9022  9002  0  Oct21 ?            00:00:16 postgres: writer
process
awips        9023  9002  0  Oct21 ?            00:00:00 postgres: wal writer
process
awips        9024  9002  0  Oct21 ?            00:00:03 postgres: autovacuum
launcher process
awips        9025  9002  0  Oct21 ?            00:01:36 postgres: stats
collector process
```

```

awips      9149  9002  0 17:31 ?          00:00:25 postgres: awips
metadata 165.92.29.133(60513) PARSE
awips      9442  9438  0 Oct21 ?          00:00:00 bash -c
/awips2/python/bin/python
awips      9443  9442  0 Oct21 ?          00:09:33
/awips2/python/bin/python -u /awips2/python/lib/python2.7/site
awips      10055   1 1 Oct21 ?          01:24:22
/awips2/java/bin/java -cp
/awips2/rcm/data/config/res:/awips2/rcm/lib/activation
awips      11844  9444  1 18:30 ?          00:00:26
/awips2/httpd_pypies/usr/sbin/httpd -f
/awips2/httpd_pypies/etc/httpd/conf/httpd.conf
awips      11853  9444  1 18:30 ?          00:00:29
/awips2/httpd_pypies/usr/sbin/httpd -f
/awips2/httpd_pypies/etc/httpd/conf/httpd.conf
awips      11854  9444  1 18:30 ?          00:00:26
/awips2/httpd_pypies/usr/sbin/httpd -f
/awips2/httpd_pypies/etc/httpd/conf/httpd.conf
awips      11875  9444  1 18:30 ?          00:00:24
/awips2/httpd_pypies/usr/sbin/httpd -f
/awips2/httpd_pypies/etc/httpd/conf/httpd.conf
awips      12137  9002  0 18:30 ?          00:00:00 postgres: autovacuum
worker process metadata
awips      17121  9444  1 18:41 ?          00:00:21
/awips2/httpd_pypies/usr/sbin/httpd -f
/awips2/httpd_pypies/etc/httpd/conf/httpd.conf
awips      17146  9002  0 18:42 ?          00:00:00 postgres: autovacuum
worker process metadata
awips      20664  9444  1 18:46 ?          00:00:12
/awips2/httpd_pypies/usr/sbin/httpd -f
/awips2/httpd_pypies/etc/httpd/conf/httpd.conf
awips      20666  9444  1 18:46 ?          00:00:17
/awips2/httpd_pypies/usr/sbin/httpd -f
/awips2/httpd_pypies/etc/httpd/conf/httpd.conf
awips      20667  9444  1 18:46 ?          00:00:11
/awips2/httpd_pypies/usr/sbin/httpd -f
/awips2/httpd_pypies/etc/httpd/conf/httpd.conf
awips      21347  9444  0 18:48 ?          00:00:09
/awips2/httpd_pypies/usr/sbin/httpd -f
/awips2/httpd_pypies/etc/httpd/conf/httpd.conf
awips      21355  9444  0 18:48 ?          00:00:08
/awips2/httpd_pypies/usr/sbin/httpd -f
/awips2/httpd_pypies/etc/httpd/conf/httpd.conf
awips      22928  9444  0 18:51 ?          00:00:07
/awips2/httpd_pypies/usr/sbin/httpd -f
/awips2/httpd_pypies/etc/httpd/conf/httpd.conf
awips      26147  9444  1 18:59 ?          00:00:06
/awips2/httpd_pypies/usr/sbin/httpd -f
/awips2/httpd_pypies/etc/httpd/conf/httpd.conf
awips      31650  9444  1 19:01 ?          00:00:02
/awips2/httpd_pypies/usr/sbin/httpd -f
/awips2/httpd_pypies/etc/httpd/conf/httpd.conf

```

```
awips      32184  9002  0 18:12 ?          00:00:01 postgres: autovacuum
worker process  fxatext
```

**NOTE:** There should be a single postmaster process running which drives the postgreSQL AWIPS II database engine along with five (5) subsequent process threads (*logger, writer, wal writer, autovacuum, stats collector*). The ISC routing table service (*edex\_irt*) as well as the AWIPS II RadarServer (*edex\_rcm*) should be running as a stand-alone process.

### On cp1f:

```
ps -fU fxa,ldm | cut -d "-" -f1,2; ps -ef | egrep 'iscsi|nfs' | grep -v grep
```

UID	PID	PPID	C	STIME	TTY	TIME	CMD
ldm	26076	1	0	Jan28	?	00:00:02	ldmd -I 165.92.24.50
ldm	26078	26076	0	Jan28	?	01:16:24	pqact -e
ldm	26079	26076	0	Jan28	?	00:09:54	edexBridge -vx1 /usr/local/ldm/logs/edexBridge.log
root 10000	26080	26076	2	Jan28	?	03:18:19	noaaportIngester -b
root 10000	26081	26076	0	Jan28	?	00:07:34	noaaportIngester -b
root 10000	26082	26076	3	Jan28	?	05:30:52	noaaportIngester -b
root 10000	26083	26076	0	Jan28	?	00:09:10	noaaportIngester -b
root 10000	26084	26076	0	Jan28	?	00:00:02	noaaportIngester -b
root 10000	26085	26076	0	Jan28	?	00:00:02	noaaportIngester -b
root	2587	2	0	2014	?	11:40:55	[nfsiod]
root 10000	26085	26076	0	Jan28	?	00:00:02	noaaportIngester -b -m 224.0.1.6 -n -u 4 -t mhs -r 1 -s ADD

**NOTE:** The LDM should have six (6) noaaportIngester processes, edexBridge (connected to the server running Qpid), ldmd and pqact running.

### On px1f:

apache	3738	14491	0	Oct23	?	00:00:04	/usr/sbin/httpd
apache	3739	14491	0	Oct23	?	00:00:05	/usr/sbin/httpd
apache	3740	14491	0	Oct23	?	00:00:05	/usr/sbin/httpd
apache	3741	14491	0	Oct23	?	00:00:05	/usr/sbin/httpd
apache	3742	14491	0	Oct23	?	00:00:05	/usr/sbin/httpd
apache	3743	14491	0	Oct23	?	00:00:05	/usr/sbin/httpd
apache	3744	14491	0	Oct23	?	00:00:05	/usr/sbin/httpd
apache	3745	14491	0	Oct23	?	00:00:03	/usr/sbin/httpd
fxa	6766	13164	0	19:10	?	00:00:00	crond

```

fxa      6772  6766  0 19:10 ?      00:00:00 csh -c
/awips/adapt/hwr/bin/hwrn
fxa      7428  6772  0 19:10 ?      00:00:00
/usr/local/python/bin/python /aw
fxa      7595  7428  0 19:10 ?      00:00:00 [gettimetz]
<defunct>
fxa     11793 13164  0 19:12 ?      00:00:00 crond
fxa     11794 11793  0 19:12 ?      00:00:00 /bin/sh -c /bin/csh
-c '/usr/bin
fxa     11795 11794  2 19:12 ?      00:00:00 /bin/csh -c
/usr/bin/perl /awips
fxa     11958 11795  0 19:12 ?      00:00:00 /usr/bin/perl
/awips/laps/etc/aw
fxa     11960 11958  1 19:12 ?      00:00:00 /bin/csh
/awips/fxa/bin/convertS
fxa     12822 11960  0 19:12 ?      00:00:00 sleep 3
fxa     13841  1 0 Oct13 ?      00:00:01
/awips/fxa/bin/asyncPilMsgServer
fxa     13844  1 0 Oct13 ?      00:00:07
/awips/fxa/bin/asyncScheduler
fxa     14277 13844  0 Oct13 ?      00:00:04 test1 23 20 1 test1
/dev/ttylna
fxa     14278 13844  0 Oct13 ?      00:01:21 test2 25 23 2 test2
/dev/ttylnb
fxa     14279 13844  0 Oct13 ?      00:01:33 ttynlh 27 25 8
ttynlh /dev/ttyln1
fxa     14280  1 0 Oct13 ?      00:00:00 /usr/bin/perl
/awips/fxa/bin/asy
fxa     14288  1 0 Oct13 ?      00:00:00
/awips/fxa/bin/hmMonitorServer
fxa     14306  1 0 Oct13 ?      00:01:46
/awips/fxa/bin/NWWSchedule
apache  22859 14491  0 15:45 ?      00:00:03 /usr/sbin/httpd
apache  25305 14491  0 15:45 ?      00:00:05 /usr/sbin/httpd
piranha 27136  6002  0 15:50 ?      00:00:00
/usr/sbin/piranha_gui -f /etc/sy
piranha 28005  6002  0 15:50 ?      00:00:00
/usr/sbin/piranha_gui -f /etc/sy
fxa     30288  1 0 Sep19 ?      00:48:45
/awips/fxa/bin/purgeProcess -com
root    12825 12321  0 19:12 pts/0    00:00:00 grep ipvs

```

**NOTE:** There should be eight (8) httpd threads running which control the AWIPSII System Monitor. There should be two getty serial ports initialized named /dev/tty[nq][a,b] which are used by the asyncScheduler, which should also be running with the two async processes, *asyncPiMsgServer* and *asyncPollData.pl*. The AWIPS II hmMonitorServer and NWWSSchedule should be running. The GUI controller for IPVS named piranha.gui should be listed as well as the IPVS process *nanny* connected on port 9581 to the IPADDR of the DX3 and DX4.

### On px2f:

```
ps -fU ldad,fxa | cut -d "-" -f1,2; ps -ef | egrep 'iscsi|nfs' | grep -v grep
```

UID	PID	PPID	C	STIME	TTY	TIME	CMD
fxa	13193	1	0	19:13	?	00:00:00	/awips/adapt/hwr/bin/Linux/nwrxmit -g /awips/fxa/bin/NWRBrowser
fxa	13841	1	0	Oct13	?	00:00:01	/awips/fxa/bin/asyncPiMsgServer
fxa	13844	1	0	Oct13	?	00:00:07	/awips/fxa/bin/asyncScheduler
fxa	14277	13844	0	Oct13	?	00:00:04	test1 23 20 1 test1
				/dev/ttyln1a	9600 8 NONE 1 NONE		
fxa	14278	13844	0	Oct13	?	00:01:21	test2 25 23 2 test2
				/dev/ttyln1b	9600 8 NONE 1 NONE		
fxa	14279	13844	0	Oct13	?	00:01:33	ttyn1h 27 25 8
				ttyn1h	/dev/ttyln1h 9600 8 NONE 1 NONE		
fxa	14280	1	0	Oct13	?	00:00:00	/usr/bin/perl
				/awips/fxa/bin/asyncPollData.pl			
fxa	14288	1	0	Oct13	?	00:00:00	/awips/fxa/bin/hmMonitorServer
fxa	14306	1	0	Oct13	?	00:01:46	/awips/fxa/bin/NWWSSchedule
fxa	30288	1	0	Sep19	?	00:48:45	/awips/fxa/bin/purgeProcess -commit
root	4515	35	0	Sep19	?	00:00:00	[iscsi_ah]
root	4762	1	0	Sep19	?	00:00:00	brcm_iscsiuio
root	4768	1	0	Sep19	?	00:00:00	iscsid
root	4769	1	0	Sep19	?	00:00:00	iscsid
root	5298	35	0	Sep19	?	00:00:00	[iscsi_q_3]
root	5698	35	0	Sep19	?	00:01:29	[nfsiod]
root	5970	35	0	Sep19	?	00:00:00	[nfsd4]
root	5971	1	0	Sep19	?	00:00:00	[nfsd]
root	5972	1	0	Sep19	?	00:00:00	[nfsd]
root	5973	1	0	Sep19	?	00:00:00	[nfsd]
root	5974	1	0	Sep19	?	00:00:00	[nfsd]
root	5975	1	0	Sep19	?	00:00:00	[nfsd]
root	5976	1	0	Sep19	?	00:00:00	[nfsd]

```

root      5977      1  0 Sep19 ?      00:00:00 [nfsd]
root      5978      1  0 Sep19 ?      00:00:00 [nfsd]

```

**NOTE:** There should be eight (8) nfsd threads running and two (2) iscsid daemons running which control the /data\_store filesystem export. The AWIPSII LDAD and FSI processes should also be running and should match those in the output above (with the exception of the node domain name, which will match your site ID).

## 25.12 EDEX Startup and Shutdown Procedures

Although EDEX is installed only on the DX 3/4 cluster, it is supported by applications running on several servers. The actual EDEX server software is installed on both DX3 and DX4. Please Note: For large memory servers<sup>3</sup> an additional EDEX process, EDEX/DAT, is present. Additional software necessary for proper functionality of the EDEX is installed and runs on the DX1/2 cluster, the CP1/2 cluster and the PX1/2 cluster. DX1/2 and PX1/2 are set up into heartbeat clusters; although the software is installed on both servers, it is running on only one server at a time in each cluster. IP aliasing is used to provide a single login to the active member of each cluster. In the case of CP1/2, no automatic failover currently exists. As a result, AWIPS II software normally runs on CP1; in the case of failover, references to CP1 should be changed to CP2.

### 25.12.1 AWIPS II/EDEX Software Dependencies

EDEX is designed to be a distributed processing system. This provides additional system stability by reducing the impact of individual server shutdowns. For example, since the EDEX server software runs on both DX3 and DX4, it is possible to bump<sup>4</sup> DX3 without completely interrupting data processing.

There are some dependencies among the various software systems, however. For example, the Apache Advanced Message Protocol Message Broker (QPID) service on the CP1/2 cluster must be running before any EDEX processes on DX3 or DX4 can be started. Exhibit 25.12.1-1 shows the dependencies among the EDEX software. Because EDEX is the same on both DX3 and DX4, it is shown as a single bubble in the dependency graph.

In Exhibit 25.12.1-1, operational dependencies are shown as lines between the bubbles representing processes. Two types of dependencies are identified: Hard<sup>5</sup> dependencies are shown as solid lines; soft<sup>6</sup> dependencies are shown as dotted lines. Dependencies run top to bottom; the upper of a pair of dependent processes must be running before the lower

<sup>3</sup> In this case, large memory means at least four gigabytes (GB) of onboard memory.

<sup>4</sup> Shut down and restart.

<sup>5</sup> In a hard dependency, a dependent process will not start if the other process is not running. Thus, EDEX (on DX3 or DX4) will not start unless QPID is running.

<sup>6</sup> In a soft dependency, the dependent process does not require the other process to start, but the output of the dependent process may be lost. In this case, LDM(D) and RCM are data producers for which EDEX (on DX3 and DX4) is a data consumer; if EDEX is not running, the data provided by LDM(D) and RCM does not get processed and may be lost.

one can be started. Conversely, the lower of a pair of dependent processes should be stopped before the upper process may be stopped.

From Exhibit 25.12.1-1 we see that there is a dependency between EDEX (on DX3/4) and QPID. As a result, 1) QPID must be started before starting EDEX, and 2) EDEX must be stopped before stopping QPID. The dependency between EDEX (on DX3/4) and RCM, however, is soft; EDX will start even if RCM has not been started, but will log communication errors related to RCM.

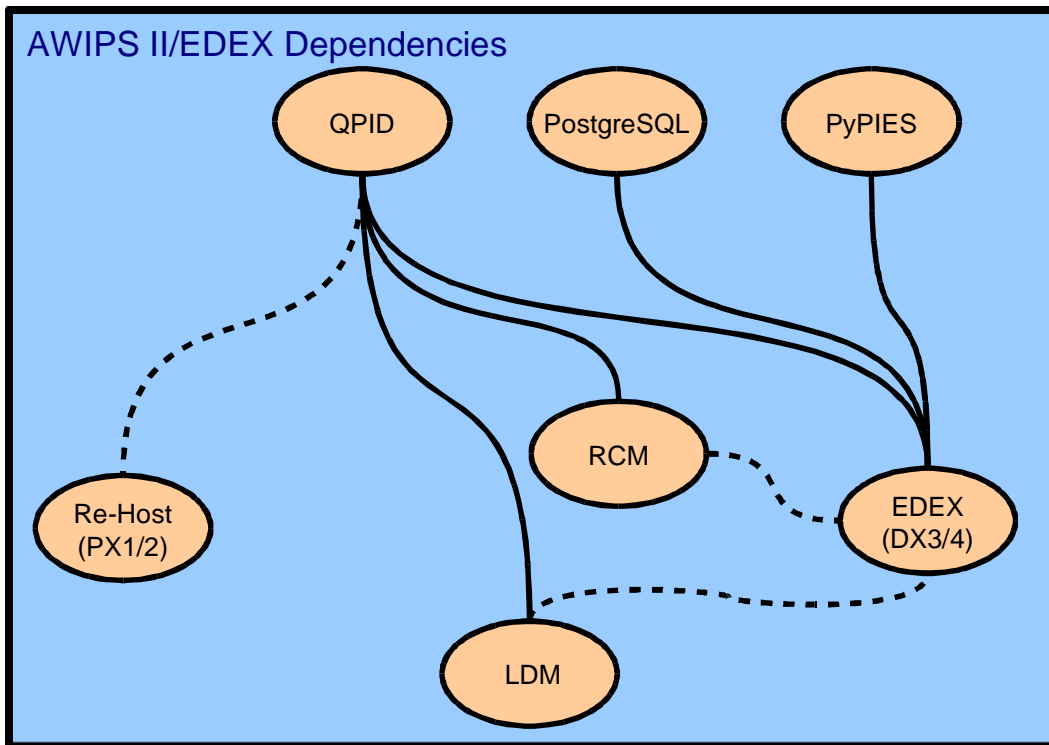

**Exhibit 25.12.1-1. AWIPS II Server Software Dependencies**

Also in Exhibit 25.12.1-1, note that no dependency exists between RCM and Local Data Manager (LDM); as a result, LDM and RCM may be started in any order.

### 25.12.2 Starting AWIPS II/EDEX Software

Because of the previously discussed software dependencies within the EDEX system, the EDEX software should be started in a specific order. Please refer to Chapter 21 for complete system startup.

Refer to Exhibit 25.12.1-1 to determine software dependencies. What follows is the approved sequence for a full start of the EDEX software system.

The approved steps to follow to perform a complete startup of the AWIPS II/ EDEX system, assuming no processes are running on any server, are:

1. Log into DX1.

**Enter:** `ssh root@dx1`

2. Start the DX1 high-availability package.

**Enter:** `hb_run a2dx1apps`

3. Start QPID

Start LDM, pulse, and QPID on CPSBN1. Then verify that they are accessible and that software is running. This is necessary because most processes have a dependency on QPID, but the processes running on the CPSBN do not depend on any other process or mount to function properly.

**Note:** If site with remote CPs, then power up px1 at this time and start up pulse and qpid as indicated below.

Connect to cpsbn1 via the System Console

Check to see if a2cp1apps is running.

**Enter:** `hb_stat`

**Enter:** `tail -f /var/log/cluster`

If the package fails to start after a few minutes, force the package start.

**Enter:** `hb_run a2cp1apps`

Check to see if LDM software is running

**Enter:** `ps -fu ldm`

If the processes are NOT running, perform the following two steps:

**Enter:** `service ldmcp start`

**Enter:** `ps -fu ldm` [check for processes]

**Enter:** `ps -fu awips`

If QPID is not running, then perform the following two steps:

**Enter:** `service qpidd start`

**Enter:** `ps -fu awips` [check for qpidd]

**Enter:** `ps -wef|grep pulse`

If IPVS (pulse) is not running perform following two steps:

**Enter:** `service pulse start`

4. Start EDEX.



**Enter:** `ssh dx3 "service edex_camel start"`

**Enter:** `ssh dx4 "service edex_camel start"`

5. Start the PX1 high-availability package.

**Enter:** `ssh px1 "hb_run a2px1apps"`

6. Start the PX2 high-availability package.

**Enter:** `ssh px2 "hb_run a2px2apps"`

7. Start the DX2 high-availability package.

**Enter:** `ssh dx2 "hb_run a2dx2apps"`

**NOTE:** IPVS, which runs on the CP1/2 cluster, is part of the Red Hat Linux Kernel. As a result, it is automatically started when the CP servers are started.

### 25.12.3 Verifying Software Execution

Verifying EDEX software execution is accomplished by logging into each of the servers and running one or more commands. The output from these commands is then evaluated to determine if the expected software is running.

Because software dependencies are not critical in checking for software execution, the commands are grouped by server; this allows a minimum number of logins in the verification process.

The System V service scripts can be used to validate execution of some of the EDEX processes; in addition, the methods presented here use variations of a simple Linux `ps` command. Although here, they are being performed by the root user, normally any user can execute the `ps`-based commands; only the root user can run the System V service.

The basic steps to verify software execution are:

1. On DX1/2:

```
ssh root@dx1f
```

```
hb_stat
```

```
ps -ef | grep postmaster | grep -v grep | cut -b -80
```

```
service edex_postgres status
```

```
ps -ef | grep Radar | grep -v grep | cut -b -80
```

```
service edex_rcm status
```

```
ps -ef | grep logging | grep -v grep | cut -b -80
```

```
service httpd-pypies status
```

```
ssh root@dx2f
```

```
ps -ef | grep httpd_pypies | grep -v grep | cut -b -80
```

2. On CP1/2:

```
ssh root@cpsbn1
```

```
ps -ef | grep ldmd | grep -v grep | cut -b -80
service ldmcp status
ps -ef | grep gpidd | grep -v grep | cut -b -80
service awips2_qpidd_cluster_ status
ps -ef | grep pulse | grep -v grep | cut -b 80
```

3. On PX1/2:

```
ssh root@px2f

hb_stat
ps -fu fxa -u ldad
```

4. On DX3 and DX4:

```
ssh root@dx3

ps -ef | grep esb.Main | grep -v grep | cut -b -80
service edex_camel status
ssh root@dx4
ps -ef | grep esb.Main | grep -v grep | cut -b -80
service edex_camel status
```

**NCEP Only:** For DX5 and DX6, use the same step shown above for DX3 and DX4.

**NOTE:** Each command is entered on a single line. Also note that these commands can be performed via remote login, *ssh*, from DX1.

When the EDEX server software is running, each of these commands will return one or more lines of output. The number of lines of output may vary depending on the number of instances of processes that are running. The expected number of lines of output for each command is shown in Table 25.12.3-1.

**Table 25.12.3-1. Expected Output from *ps* Commands**

Server	Command	Lines
DX1/2	<code>ps -ef   grep postmaster   grep -v grep   cut -b -80</code>	1
	<code>ps -ef   grep Radar   grep -v grep   cut -b -80</code>	1
	<code>ps -ef   grep httpd_pypies   grep -v grep   cut -b -80</code>	> 1
	<code>ps -ef   grep logging   grep -v grep   cut -b -80</code>	1
CP1/2	<code>ps -ef   grep ldmd   grep -v grep   cut -b -80</code>	2
	<code>ps -ef   grep qpidd   grep -v grep   cut -b -80</code>	1
PX1/2	<code>ps -fu fxa -u ldad</code>	> 1
DX3	<code>ps -ef   grep esb.Main   grep -v grep   cut -b -80</code>	3 or 4
DX4	<code>ps -ef   grep esb.Main   grep -v grep   cut -b -80</code>	3 or 4

**NOTE:** To determine the correct number of lines (three or four) to expect on DX3 and DX4, you need to check the installed memory on each server. If the amount of memory is greater than 4 GB, you should see four lines of output; otherwise you should see three lines of output.

In addition to the commands shown above, it may be desirable to check the various process log files to determine if the software has started.

#### 25.12.4 Stopping EDEX Software

Because of the previously discussed software dependencies within the EDEX system, the EDEX software should be stopped in a specific order.

Refer to Exhibit 25.12.1-1 to determine software dependencies. The standard procedure is to stop LDM prior to stopping EDEX on DX3 and DX4.

**NOTE:** The PX1/2 and DX1/2 clusters both utilize high-availability packages to manage software. Because each high-availability packages manages the virtual server name assigned to the package, you cannot use the virtual server name to log in when stopping the software. The correct procedure is:

Log into the server via the virtual server name.

Use *hostname* to determine the actual server name.

For the a2px1apps package, the command sequence is:

```
ssh px1f "hostname"  
ssh xxx "hb_halt a2px1apps"
```

where xxx is the server name determined by the hostname command. Both these commands are normally executed from DX1 after logging in as the root user.

The approved steps to perform a complete shutdown of the EDEX system are:

1. Log into DX1.

```
Enter: ssh root@dx1
```

2. Stop LDM on cpsbn1/1 cluster.

```
Enter: ssh cpsbn1 "service ldmcp stop"
```

```
Enter: ssh cpsbn2 "service ldmcp stop"
```

3. Stop the DX2 high-availability package.

```
Enter: ssh dx2f "hostname"
```

```
Enter: ssh xxx "hb_halt a2dx2apps"
```

4. Stop the PX2 high-availability package.

```
Enter: ssh px2f "hostname"
```

```
Enter: ssh xxx "hb_halt a2px2apps"
```

5. Stop the PX1 high-availability package.

```
Enter: ssh px1f "hostname"
```

```
Enter: ssh xxx "hb_halt a2px1apps"
```

6. Stop EDEX.

**Enter:** `ssh dx4 "service edex_camel stop"`

**Enter:** `ssh dx3 "service edex_camel stop"`

**Note:** For dx5, dx6 at NCEP Centers, use the command shown above, replacing dx3 and dx4 with dx5 and dx6.

7. Stop the DX1 high-availability package.

**Enter:** `ssh dx1f "hostname"`

**Enter:** `ssh xxx "hb_halt a2dx1apps"`

8. Stop CPSBN1 high-availability package.

**Enter:** `ssh cp1f "hostname"`

**Enter:** `ssh xxx "hb_halt a2cp1apps"`

9. Stop QPID.

`ssh cpsbn1 "service edex_qpid stop"`

### 25.12.5 Verifying Software Shutdown

Verifying EDEX software shutdown is accomplished by logging into each of the servers and running one or more commands. The output from these commands is then evaluated to determine if the expected software has been stopped.

Because software dependencies are not critical in checking for software shutdown, the commands are grouped by server; this allows a minimum number of logins in the verification process.

The System V service scripts can be used to validate shutdown of some of the EDEX processes; in addition, the methods presented here use variations of a simple Linux *ps* command. Although these are shown as being performed by the root user, the *ps*-based commands can normally be executed by any user; the System V service scripts can only be run by the root user.

The basic steps to verify successful software halt are:

1. On DX1/2:

```
ssh root@dx1
```

```
hb_stat
```

```
ps -ef | grep postmaster | grep -v grep | cut -b -80
service edex_postgres status
```

```
ps -ef | grep Radar | grep -v grep | cut -b -80
service edex_rcm status
```

```
ps -ef | grep logging | grep -v grep | cut -b -80
service httpd-pypies status
```

```
ssh root@dx2
```

```
ps -ef | grep httpd_pypies | grep -v grep | cut -b -80
```

## 2. On CP1/2:

```
ssh root@cpsbn1
ps -ef | grep ldm | grep -v grep | cut -b -80
service ldmcp status
ps -ef | grep qpidd | grep -v grep | cut -b -80
service qpidd status
ps -ef | grep pulse | grep -v grep | cut -b -80
service pulse status
```

```
ssh root@cpsbn2
ps -ef | grep ldm | grep -v grep | cut -b -80
service ldmcp status
ps -ef | grep qpidd | grep -v grep | cut -b -80
service qpidd status
ps -ef | grep pulse | grep -v grep | cut -b -80
service pulse status
```

## 3. On PX1/2:

```
ssh root@px1
ps -fu fxa -u ldad
hb_stat
ssh root@px2
ps -fu fxa -u ldad
hb_stat
```

## 4. On DX3 and DX4:

```
ssh root@dx3
ps -ef | grep esb.Main | grep -v grep | cut -b -80
service edex_camel status
ssh root@dx4
ps -ef | grep esb.Main | grep -v grep | cut -b -80
service edex_camel status
```

**NOTE:** Each command is entered on a single line. Also note that these commands can be performed via remote login, ssh, from DX1.

When the software has been successfully stopped, each of the listed *ps* commands will display no output and each *service* command will provide a “service not running” message; the exact wording will vary depending on the service.

In addition to the commands shown above, it may be desirable to check the various process log files to determine that the software stopped execution.

### 25.12.6 Alternative Shutdown Scenarios

In addition to the complete startup and shutdown processes, it may be desirable to perform a partial shutdown and restart of the EDEX systems. Although a number of partial shutdown/restart scenarios are possible, only three are considered here: restarting the EDEX services on DX3; restarting PostgreSQL on DX1/2; restarting QPID on CP1/2.

The general rule: *When stopping an EDEX system, all dependent systems must be stopped first.* With this rule in mind, the three scenarios are:

### *Scenario 1: Restarting the EDEX Services on DX3*

We can stop and restart EDEX on DX3 without stopping and restarting the other EDEX system components. (Note that for CAVE to operate successfully, at least one EDEX request process must be running.)

The steps for this scenario are:

1. On DX3, stop EDEX services:

```
ssh root@dx3
service edex_camel stop
```

2. On DX3, verify software shutdown:

```
ssh root@dx3
ps -ef | grep esb.Main | grep -v grep | cut -b -80
service edex_camel status
```

3. On DX3, start EDEX services:

```
ssh root@dx3
service edex_camel start
```

4. On DX3, verify software execution:

```
ssh root@dx3
ps -ef | grep esb.Main | grep -v grep | cut -b -80
service edex_camel status
```

Scenario 1 may be used when it is necessary to modify EDEX configuration files. Because the EDEX services on DX3 and DX4 are independent, each can be stopped and restarted without affecting the rest of the system. Other EDEX system components are not affected.

**NOTE:** Both EDEX shutdown and restart can take some time. As a result, if EDEX has not shut down (Step 2), wait a short time and retry the test. The same is true for the startup.

### *Scenario 2: Restarting PostgreSQL on DX1/2*

In Exhibit 25.12.1-1, we see that there are dependencies between PostgreSQL and the EDEX services on DX3 and DX4. As a result, the EDEX services on DX3 and DX4 should be stopped before stopping PostgreSQL. The steps for this scenario are:

1. On DX3, stop EDEX services:

```
ssh root@dx3
service edex_camel stop
```

2. On DX3, verify software shutdown:

```
ssh root@dx3
ps -ef | grep esb.Main | grep -v grep | cut -b -80
service edex_camel status
```

3. On DX4, stop EDEX services:

```
ssh root@dx4
service edex_camel stop
```

4. On DX4, verify software shutdown:

```
ssh root@dx4
ps -ef | grep esb.Main | grep -v grep | cut -b -80
service edex_camel status
```

5. On DX1/2, stop PostgreSQL:

```
ssh root@dx1f
service edex_postgres stop
```

6. On DX1/2, verify software shutdown:

```
ssh root@dx1f
ps -ef | grep postmaster | grep -v grep | cut -b -80
service edex_postgres status
```

7. On DX1/2, start Postgresql:

```
ssh root@dx1f
service edex_postgres start
```

8. On DX1/2, verify software startup:

```
ssh root@dx1f
ps -ef | grep postmaster | grep -v grep | cut -b -80
service edex_postgres status
```

9. On DX3, start EDEX services:

```
ssh root@dx3
service edex_camel start
```

10. On DX3, verify software startup:

```
ssh root@dx3
ps -ef | grep esb.Main | grep -v grep | cut -b -80
service edex_camel status
```

11. On DX4, start EDEX services:

```
ssh root@dx4
service edex_camel start
```

12. On DX4, verify software startup:

```
ssh root@dx4
ps -ef | grep esb.Main | grep -v grep | cut -b -80
service ede_camel status
```

**NOTE:** Refer to the previous discussion on validating system start and stop for information on interpreting the “verify” steps.

Scenario 2 may be followed when it is necessary to stop the database briefly; for example, to modify its configuration files, which require a software restart. Keep in mind that, although AWIPS II applications access the database via EDEX, local applications and other non-AWIPS II applications may access the database directly. Any applications that access the database should be shut down before performing a database restart.

**NOTE:** Scenario 2 assumes a short downtime (maximum of 10 to 15 minutes); for longer downtimes, you should also stop and restart LDM(D) and RCM.

### *Scenario 3: Restarting QPID on CP1/2*

As seen in Exhibit 25.12.1-1, there are hard dependencies between QPID and EDEX (on both DX3 and DX4) and RCM. In fact, the only EDEX components that are independent of QPID are PostgreSQL and PyPIES. The steps for this scenario are:

1. On CP1/2, stop LDM:

```
ssh ldm@cp1f
ldmadmin stop
```

2. On CP1/2, verify software shutdown:

```
ssh root@cp1f
ps -ef | grep ldm | grep -v grep | cut -b -80
```

3. On PX2, stop rehosted software:

```
ssh root@px2f "hostname"
ssh root@xxx "hb_halt a2px2apps
```

4. On PX2, verify software shutdown:

```
ssh root@xxx
ps -fu fxa -u ldad
```

5. On DX1/2, stop RCM:

```
ssh root@dx1f
service edex_rcm stop
```

6. On DX1/2, verify software shutdown:

```
ssh root@dx1f
ps -ef | grep Radar | grep -v grep | cut -b -80
service edex_rcm status
```

7. On DX3, stop EDEX services:

```
ssh root@dx3
service edex_camel stop
```

8. On DX3, verify software shutdown:

```
ssh root@dx3
ps -ef | grep esb.Main | grep -v grep | cut -b -80
service edex_rcm status
```



9. On DX4, stop EDEX services:

```
ssh root@dx4
service edex_camel stop
```

10. On DX4, verify software shutdown:

```
ssh root@dx4
ps -ef | grep esb.Main | grep -v grep | cut -b -80
service edex_rcm status
```

11. On CP1/2, stop QPID:

```
ssh root@cplf
service qpidd stop
```

12. On CP1/2, verify software shutdown:

```
ssh root@cplf
ps -ef | grep qpidd | grep -v grep | cut -b -80
service qpidd status
```

13. On CP1/2, start QPID:

```
ssh root@cplf
service qpidd start
```

14. On CP1/2, verify software startup:

```
ssh root@cplf
ps -ef | grep qpidd | grep -v grep | cut -b -80
service qpidd status
```

15. On DX3, start EDEX services:

```
ssh root@dx3
service edex_camel start
```

16. On DX3, verify software startup:

```
ssh root@dx3
ps -ef | grep esb.Main | grep -v grep | cut -b -80
service edex_camel status
```

17. On DX4, start EDEX services:

```
ssh root@dx4
service edex_camel start
```

18. On DX4, verify software startup:

```
ssh root@dx4
ps -ef | grep esb.Main | grep -v grep | cut -b -80
service edex_camel status
```

19. On DX1/2, start RCM:

```
ssh root@dx1f
service edex_rcm start
```

20. On DX1/2, verify software startup:

```
ssh root@dx1f
ps -ef | grep Radar | grep -v grep | cut -b -80
service edex_rcm status
```

21. On PX2, start rehosted processes:

```
ssh root@px2 "hb_run a2px2apps"
```

22. On PX2, verify software start:

```
ssh root@px2 "hb_stat a2px2apps"
ssh root@px2 "ps -fu fxa -u ldad"
```

23. On CP1/2, start LDM(D):

```
ssh ldm@cp1f
ldmadmin start
```

24. On CP1/2, verify software startup:

```
ssh root@cp1f
ps -ef | grep ldm | grep -v grep | cut -b -80
```

### 25.13 Troubleshooting Basic AWIPS II Data Flow

This section “connects the dots,” the dots being the recipes presented in this Administration Guide. In doing so, the goal is to provide a series of steps to follow to diagnose data ingest problems. The data flow consists of a series of steps like links in a chain. The approach used here is to start at the point where the problem is detected and then search upstream until the broken link is found. Once that link is repaired, check the data flow and continue the search as needed. This can be represented as a flow chart. See Exhibit 25.13-1.

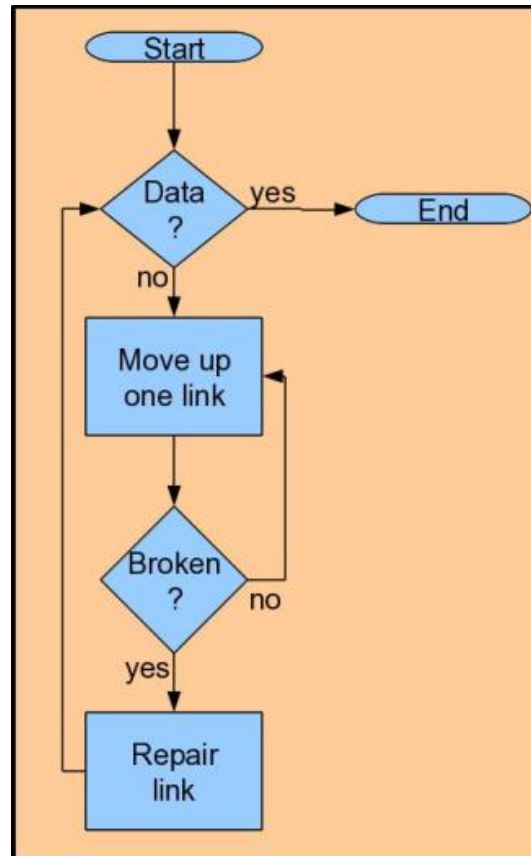

**Exhibit 25.13-1. Basic Data Flow Troubleshooting**

The next two examples illustrate this basic approach to troubleshooting the data flow.

***Example 25.13-1: Troubleshooting Satellite Data Flow***

The basic flow of satellite data into AWIPS II was discussed under Section 25.3, [Basic Data Flow Concepts](#). Exhibit 25.13-1 traces data from the SBN to the EDEX ingest component. Missing from Exhibit 25.13-1, however, is the Data Store, which contains the decoded data after it has been processed by the AWIPS Ingest processes. Exhibit 25.13-2 presents a more complete picture of the data flow from the SBN through EDEX to the Data Store. (The exhibit does not show the client application; it only shows the dataflow.)

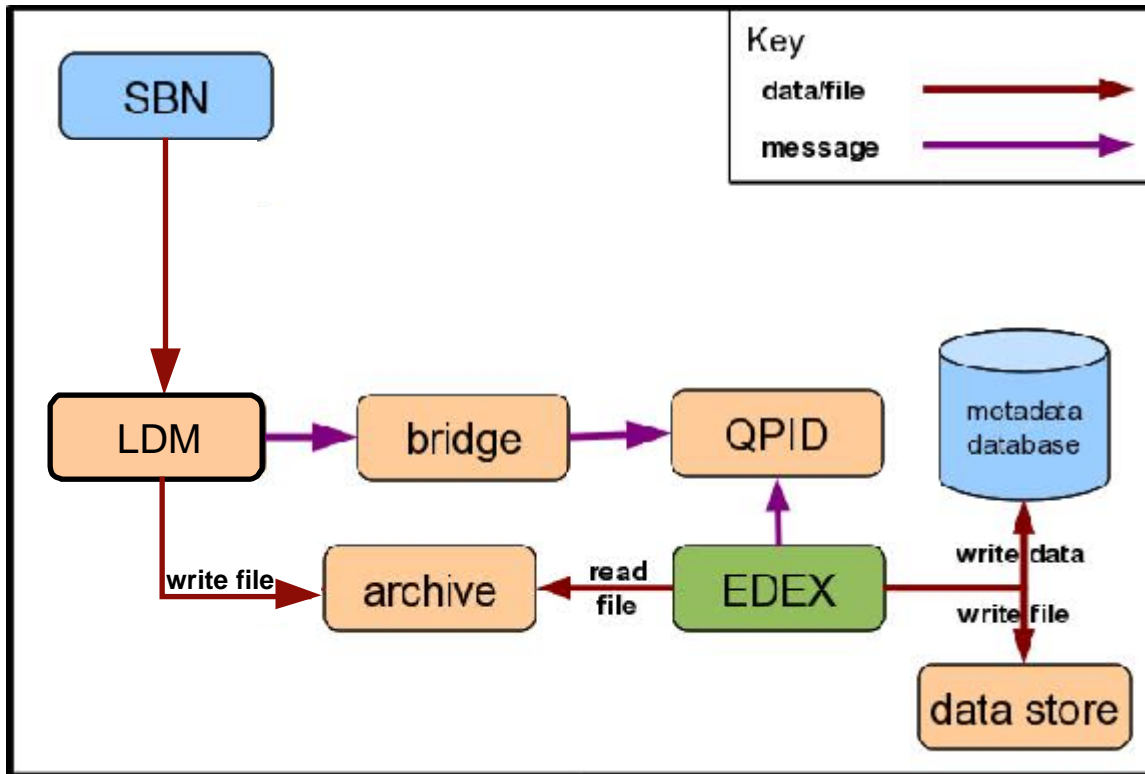

Exhibit 25.13-2. Expanded EDEX Data Flow

Suppose that CAVE is not displaying the satellite data. From Exhibit 25.13-2, we see that the place to start is at the metadata database and the data store and then work upstream. Follow the applicable examples in this chapter.

1. Verify that satellite data is available in the data store.
2. Verify that satellite metadata is available in the database.
3. Verify that satellite data is being ingested.
4. Verify that QPID satellite queue is current.
5. Verify that satellite data is being provided by the LDM.

#### **Example 25.13-2: Troubleshooting Radar Data Flow**

Radar data follows the same basic data flow as satellite data with one exception: radar data is available via the ORPG as well as the SBN. ORPG data is handled in AWIPS II by the Radar Server (RCM).

Suppose that CAVE is not displaying radar data. From Exhibit 25.13-2, we see that the place to start is at the metadata database and the data store and then work upstream. In addition, the Radar Server must be checked, of course. Follow the applicable examples in this chapter.

1. Verify that radar data is available in the data store.
2. Verify that radar metadata is available in the database.

3. Verify that radar data is being ingested.
4. Verify that QPID radar queue is current.
5. Verify that radar data is being provided by LDM.
6. Verify that radar data is being provided by RCM.

# **Chapter 26**

## **Thin Client**

## Chapter 26. Thin Client

### Table of Contents

	<i>Page</i>
<b>26.1</b> Introduction.....	1
<b>26.2</b> Configuring the Apache Proxy Server.....	1
26.2.1 Hardware/Software Requirements .....	1
26.2.2 Client Information.....	2
26.2.3 Security Considerations .....	2
26.2.4 Log Files .....	2
26.2.5 Troubleshooting .....	2
<b>26.3</b> Client Installation and Configuration.....	3
26.3.1 Installing and Starting the Linux Client.....	3
26.3.1.1 Hardware Prerequisites.....	3
26.3.1.2 Software Prerequisites .....	3
26.3.1.3 Directory Structure .....	3
26.3.1.4 User awips .....	4
26.3.1.5 Repository Access and Setup .....	4
26.3.1.6 Installing Thin Client.....	6
26.3.1.7 Networking Configuration .....	7
26.3.1.8 Starting Thin Client .....	8
26.3.2 Installing the Win32 Client.....	8
26.3.4 Removing Configuration and Cached Files .....	9
 Table 26.3.2-1. Win32 CAVE Hardware/Software Requirements.....	 8

## 26.1 Introduction

The Thin Client component implements support for NWS enterprise requirements for remote access to baseline AWIPS II capabilities. The Thin Client will be able to take advantage of new and enhanced AWIPS II capabilities in a seamless manner as they are deployed to the baseline.

The Thin Client is targeted to the following users:

1. Center Weather Service Units (CWSU)
2. Weather Service Offices (WSO)
3. Incident Support Specialists (ISS) including Incident Meteorologists (IMET)
4. NCEP Centers, to provide partial support for their Continuity of Operations Planning (COOP) requirements and remote access requirements
5. River Forecast Centers (RFC), to provide partial support for backup requirements.

The Thin Client will also be used to brief state and local emergency managers during incident operations.

The Thin Client component adds the following features to CAVE/AlertViz:

- Support for access to EDEX via a single well-known port (e.g., http port 80). This allows CAVE to run on firewall restricted networks
- Support for compression of data sent to/from EDEX
- Local caching of localization, map, and weather data
- Timed refresh of data.

This chapter describes the configuration needed to support the Thin Client component of CAVE.

## 26.2 Configuring the Apache Proxy Server

The Thin Client function of CAVE uses an Apache httpd server to perform data compression and map responses from EDEX Services and Pypies Ports to a single port. Users outside the NOAA firewall will be required to log in with their NOAA username and password.

### 26.2.1 Hardware/Software Requirements

Clients must be able to access the compression proxy server on port 80 for users inside the NOAA firewall and port 443 (https) for users outside the NOAA firewall.

The compression proxy server must be able to access EDEX on the “Services” and “Pypies” ports. The Apache httpd server providing the compression proxy service can also provide other web services. The server can run on the same system as EDEX.



Because the purpose of the compression proxy server is to compress the data stream between EDEX and the clients, it is important that the compression proxy server have a high-speed, high-capacity, low-latency connection to the EDEX servers.

Memory and CPU utilization will depend on the number of simultaneous users, but a machine with at least 2GB of RAM is recommended. There is no local storage of data; the only disk space required is space for the httpd installation and log files.

At WFOs that support CWSUs, the compression proxy server runs on px1f. At sites that support external users (e.g., IMETs, DSS meteorologists) the compression proxy server runs on the LDAD server.

### **26.2.2 Client Information**

When Thin Client is started for the first time, users will need to enter the addresses of the proxy services either in the Localization Dialog at startup or in the CAVE Preferences dialog after startup. The addresses will have the following format for users inside the NOAA firewall.

Proxy Server: `http://hostname.noaa.gov/services`

For users outside the NOAA firewall:

Localization Server: `https://hostname.noaa.gov/services`

The string “hostname.noaa.gov” must be replaced with the name or IP address of the host running the Apache httpd proxy compression server.

### **26.2.3 Security Considerations**

To Be Determined. This will be site dependent.

### **26.2.4 Log Files**

The httpd server by default creates `access_log` and `error_log`. `compression_log` is created when using the Apache httpd as a compression proxy server.

These files are created in `/var/log/httpd` and managed by Apache and logrotate.

- `access_log`: Logs all client requests.
- `error_log`: Logs errors from the proxy server.
- `compression_log`: Logs the amount of compression and service time.

The location, contents, and formatting of these logs are defined by the Apache configuration files.

### **26.2.5 Troubleshooting**

The following three principal issues are unique to the Thin Client:

1. Can the Apache proxy successfully fetch data from the EDEX and Pypies servers? Errors of this kind will be logged in the “`error_log`”.

2. Can the Thin Client access the Apache proxy? Successful connections will be logged in the “access\_log”. Unsuccessful connections are typically due to firewall or client connectivity issues and there will be nothing in the local logs.
3. Is compression working? Compression is logged in `/var/log/httpd/compression_log`. Only the first connection to the server is uncompressed; all others will show a compression percentage.

## **26.3 Client Installation and Configuration**

### **26.3.1 Installing and Starting the Linux Client**

This section provides instructions and information to support installation of the Thin Client on a Linux platform for various scenarios. If you are updating a previous installation (for example, on an AWIPS Remote Display (ARD) workstation at a CWSU) you can skip directly to Subsection 26.3.1.6, Installing Thin Client.

#### **26.3.1.1 Hardware Prerequisites**

Hardware requirements for running the Thin Client are almost the same as the requirements for running CAVE. (The Thin Client is, after all, CAVE running with some additional data compression and caching functionality.) The only additional requirement for a Thin Client workstation or laptop is to allow each user to store at least 2GB of cache files under his or her home directory.

The hardware requirements for Thin Client follow.

- At least 4GB memory. More is better. Performance improves with more memory up to about 12GB. Do not run more than one instance of Thin Client if your laptop has less than 12 GB of memory.
- Graphics card with at least 512 MB of dedicated on-board memory. More is better, up to about 1.5GB. Graphics card must support OpenGL 2.2 or later. Note: Nvidia adapters seem to work best. That is not an explicit requirement, but other graphics adapters are not tested as extensively with AWIPS II.
- At least 2GB per user of cache storage space in the users’ home directories.

#### **26.3.1.2 Software Prerequisites**

Thin Client requires the same operating system (OS) and infrastructure software as CAVE. Thin Client (that is, CAVE) builds are available for 64-bit RHEL 6.x.

#### **26.3.1.3 Directory Structure**

The directory hierarchy in which Thin Client gets installed should be mounted at two places: `/usr/local/viz` and `/awips2`. The Eclipse installer does not understand symbolic links, so they cannot be used. Here is one possible approach.

Create a directory in which you will install Thin Client. You should do this on a partition with a lot of space available.

```

TYPE:      export INST=/data/tc
TYPE:      mkdir $INST
TYPE:      mkdir /awips2
TYPE:      mkdir /usr/local/viz
TYPE:      mount --bind $INST /awips2
TYPE:      mount --bind $INST /usr/local/viz

```

Add the necessary lines to `/etc/fstab` to have the directory mounted at boot time. Here are examples.

```

/data/tc      /awips2      ext3      bind
/data/tc      /usr/local/viz  ext3      bind

```

**IMPORTANT NOTE:** *These are only examples.* In your case, they must be adapted to your platform. An incorrect `fstab` file can render the system unbootable.

#### 26.3.1.4 User `awips`

Make sure you have User **awips** belonging to group `fxalpha` before you proceed.

Enter the command:

```

TYPE:      id awips

```

You should see output like:

```

uid=501(awips) gid=501(fxalpha) groups=501(fxalpha)

```

The user and group numbers do not matter. If you do not have the group and user, create them with the following commands.

```

TYPE:      groupadd fxalpha
TYPE:      useradd -m -g fxalpha awips

```

#### 26.3.1.5 Repository Access and Setup

The user will use the `yum` utility to install CAVE. `Yum` pulls the necessary RPM packages from a repository – a special directory hierarchy containing the packages and metadata. At a high level, the user needs to accomplish the following two tasks:

1. Create the repository if it does not already exist.
2. Create or edit the configuration file ("repo" files); this file tells `yum` where to find the repository and how to access it.

These two tasks can be accomplished in a number of ways. A few examples follow.

**Example 1: Standard CWSU ARD Setup: Installation via http**

The repository access and setup work for ARDs was done with the first installation of Thin Client on ARD. It need not be repeated. It is described here because it may be a useful starting point for other configurations.

The ARD workstations installed at CWSUs have network connections to their supporting WFOs, so they can use the repository in /data/fxa/INSTALL/awips2 at the WFO. This is the same repository that is used to install AWIPS II software at the WFO. Using this repository to install or update CAVE on the ARD is convenient, and it also ensures that the ARD gets a version of CAVE that is compatible with the EDEX at the WFO.

Create a file on the ARD called “/etc/yum.repos.d/awips2.repo”. The file should contain the following:

```
[awips2repo]
name=AWIPS II Repository
baseurl=http://px1f/tcrepo/dataFxa/INSTALL/awips2/$basearch
enabled=1
protect=0
gpgcheck=0
[awips2noarch]
name=AWIPS II Repository
baseurl=http://px1f/tcrepo/dataFxa/INSTALL/awips2/noarch
enabled=1
protect=0
gpgcheck=0
```

The "baseurl" lines in awips2.repo tell yum where to find the repository and how to access it. In this case the URL starts with “http”, which tells yum to use the http protocol to access the repository.

The server host name in the “baseurl” line is px1f. That host name must appear in the /etc/hosts file on the ARD, or it must be resolvable to an IP address by some other mechanism. You could also use an IP address instead of the host name.

The web server running on px1f at the WFO must be able to see the repository. There must be symbolic links in the web server’s document root hierarchy pointing at the repository. Those links should already exist. If they do not, they can be created by the root user working on px1f:

```
TYPE:    mkdir -p /data/fxa/A2_SysMonitor/tcrepo
TYPE:    chmod a+rx /data/fxa/A2_SysMonitor/tcrepo
TYPE:    ln -s /data/fxa /data/fxa/A2_SysMonitor/tcrepo/dataFxa
```

**Example 2: Put Client Machine on WFO LAN**

If you are installing Thin Client on a laptop you may be able to put the laptop on the LAN of a WFO temporarily. Typically you would do that by editing `/etc/sysconfig/network` and `/etc/sysconfig/network-scripts/ifcfg-eth0`. (This assumes that the ethernet connection is made on device `eth0`.)

Make backup copies of those files first so you can restore them later. Inspect the corresponding files on an LX to determine what entries to use. Find an unused IP address or temporarily use the address of a shut-down workstation. Reboot the laptop after editing those files. Once you have put the laptop on the WFO LAN, follow Example 1.

**Example 3: Use a Local Repository**

Connect an external USB drive to a WFO with access to `/data/fxa/INSTALL/awips2` and copy that directory to the external drive. Then you can mount the drive on your target client machine.

Create the `awips2.repo` file as described in Example 1, except that you should use the file protocol rather than `http` in the `baseurl` lines and adjust the path to correspond with where you copied `awips2` and what your mount point is. For example:

```
baseurl=file:///mnt/sdc1/awips2/$basearch
baseurl=file:///mnt/sdc1/awips2/noarch
```

Note that there are three slashes after the colon in the `baseurl` lines. You could also make a tar ball of the repository and expand it on the target machine.

**26.3.1.6 Installing Thin Client**

Clean out the yum cache and verify that the repository is set up properly:

```
TYPE:      yum clean all
TYPE:      rm -rf /var/cache/yum
TYPE:      yum grouplist | grep "AWIPS II"
```

The output from the “`yum grouplist`” command should be a list of AWIPS RPM groups, one of which is “AWIPS II Visualize.” Install that group, and capture the output to a file for later inspection. Respond with a “y” to the prompt asking whether you want to do the installation. Replace the “`<hhmm>`” with a time stamp to make the script file name unique.

```
script /tmp/script.<hhmm>
yum groupupdate "AWIPS II Visualize"
exit # Exit the scripting session.
```

Check the script file for problems.

```
TYPE:      grep -i fail /tmp/script.<hhmm>
```

Edit the file.

**TYPE:**        /etc/xdg/autostart/awips2-alertviz.desktop

Change the line:

```
Exec=/bin/bash -i -c "/awips2/alertviz/alertviz.sh"
```

to

```
Exec=/bin/bash -i -c "/awips2/alertviz/alertviz.sh -
component thinalertviz"
```

AlertViz will now start in Thin Client mode automatically when a user logs in.

### 26.3.1.7 *Networking Configuration*

The Thin Client must be given an IP address for the compression proxy server. This address may be provided via the “Communications Preferences” dialog when AlertViz starts, or it may be provided in a CAVE preferences dialog. Refer to Chapter 14 of the *AWIPS CAVE-D2D User’s Manual* for information on providing the IP address via a CAVE preferences dialog. In either case, the user can provide either an IP address or a domain name. If a domain name is used it must appear in the /etc/hosts file, unless the client machine uses some other mechanism for domain name resolution. In a CWSU ARD installation, for example, there should be an /etc/hosts entry for px1f.

If the Thin Client uses JMS messaging to receive push notifications of data updates, the host name “cp1f” must be resolvable. So this name also should appear in /etc/hosts.

**Note:** This applies only to CWSU ARDs. Other cases of use are restricted to http or https communication with the servers where JMS messaging is not available.

The host name of the Thin Client machine itself must be resolvable to an IP address on which the client machine can be contacted.

For example, if the user executes the following command:

**TYPE:**        hostname

And receives an output as:

*laptop01*

Then the user must be able to ping laptop01 and get a response.

This can become an issue if the user’s client machine gets its IP address via DHCP and the user wants to give it a host name other than the generic “localhost”. In that case the user might have to edit the HOSTNAME line in /etc/sysconfig/network to be

**.....HOSTNAME=laptop01**

The user has to be sure that the name laptop01 is resolved to the IP address of the machine. The user could do that by adding laptop01 to the list of aliases for the loopback IP address in /etc/hosts, so that /etc/hosts line would look like

**127.0.0.1 localhost.localdomain localhost laptop01**

If the host name is not resolvable, then AlertViz will fail to start and the user will find a string as below in the ~/caveData/logs/consoleLogs/alertviz\*\_admin.log.

*Caused by: java.net.UnknownHostException: laptop01*

### 26.3.1.8 Starting Thin Client

AlertViz must be running before CAVE (Thin Client) is started. Ordinarily AlertViz will start at user login. If it is not running, start it manually with the command line:

```
/awips2/alertviz/alertviz.sh -component thinalertviz
```

The command line to Thin Client is:

```
/awips2/cave/cave.sh -component thinclient
```

It may be convenient to create a launcher (panel or desktop icon) to run that command.

### 26.3.2 Installing the Win32 Client

Table 23.3.2-1 lists the hardware and software requirements for the Win32 Thin Client.

**Table 26.3.2-1. Win32 CAVE Hardware/Software Requirements**

Specification	Minimum	Recommended
Processor	2GHz Intel Core Duo	2.5 GHz Intel i7 or better
Memory	2GB	4GB <sup>1</sup>
Disk Space	Approx. 1GB for program and data caches	n/a
Operating System	Windows XP <sup>2</sup>	Vista 32-bit, Windows 7 32-bit, Windows 7 64-bit
Video Card	OpenGL 2.0 capable	NVIDIA Quadro F series NVIDIA GeForce 6 or better NVIDIA m200 or better

<sup>1</sup>CAVE is a 32-bit application and can only access 2GB of memory.

<sup>2</sup>Windows XP only supports OpenGL 2.0 or better if implemented in a third-party video driver.

The Win32 install package consists of two installers.

1. AWIPS II Runtime Environment.msi: installs Java, JAI, JAI ImageIO, Python, several python site-packages, and the system DLLs needed for CAVE on Win32. This must be installed before AWIPS II CAVE.EXE.
2. AWIPS II CAVE.EXE: Installs CAVE thin client and places a shortcut on the user desktop and in the Windows Start Menu under Programs -> AWIPS II.

Administrator privileges are needed for installation. To install, just double click on the installers and follow the prompts. The AWIPS II Runtime Environment installer will install Java and Python to C:\Program Files\Raytheon. AWIPS II CAVE will install thin client CAVE to C:\Program Files\Raytheon by default; however, the installation location for CAVE can be changed at install time by altering the location specified in the Custom Setup dialog.

[**Note:** At this point, this prompt appears: “**Do you want to allow the following program from an unknown publisher to make changes to this Computer**” Yes/No. Choose ‘Yes’ to start the Installation.]

A user who attempts to run a new installation of CAVE thin client may be prompted by the Windows Firewall to allow access for “cave.exe”. The user should answer that access is allowed for private networks only. [**Note:** The user need not be an Admin to allow the access. The IMET laptop configurations that it has been tested against allow the user to enable access to either network class.]

### 26.3.3 *CAVE Features Not Supported by Thin Client*

The following CAVE features are not supported:

- Non-D2D perspectives, i.e., GFE, Hydro, MPE, National Centers, and Localization
- WarnGen
- AvnFPS (Supported for CWSU's only)
- Collaboration
- 4D Storm Cell Investigator (FSI)
- LAPS tools
- Radar applications and radar tools
- Data dissemination and upload

### 26.3.4 *Removing Configuration and Cached Files*

To start fresh with CAVE and remove all configuration or cached files, you will need to perform the following steps:

1. Shut down CAVE and AlertViz.
2. Remove caveData folder from your home directory. (ex: Linux: /home/<username>/caveData, Windows: C:\users\<username>\caveData).



# **Chapter 27**

## **Collaboration**

## Chapter 27. Collaboration

### Table of Contents

	<i>Page</i>
27.1 Introduction.....	1
27.2 Collaboration Configuration.....	1

### List of Exhibits

Exhibit 27.2-1. Collaboration Server Login Dialog.....	2
Exhibit 27.2-2. Collaboration Server Login Dialog: Sites.....	2
Exhibit 27.2-3. Collaboration Server Login Dialog: Site Roles.....	3
Exhibit 27.2.4. Example: Config.xml SITE File.....	4

## 27.1 Introduction

Collaboration is a component of CAVE. It offers two main functions, chatting and sharing displays. “Chat” allows users to chat with fellow forecasters and offices in a chat room or send them instant messages. “Sharing displays” adds to the chat room’s capabilities and allows the room’s creator to show a CAVE map display to other participants in the room.

The Collaboration capabilities in AWIPS II as a whole replace the capabilities of 12Planet. The “NWS Collaboration Room” tab is a chat room within Collaboration that replaced the nws\_collaboration chat room found in the 12Planet application. The “NWS Collaboration Room” tab opens by default once you are logged into Collaboration (users who have deactivated the “Join Discussion On Login” option in the Preferences dialog can open the NWS Collaboration Room by clicking the Display Feed button). The nws\_collaboration chat room was the main/default room that appeared when loading 12Planet. In other words, Collaboration is to 12Planet as the NWS Collaboration Room is to nws\_collaboration.

This chapter provides instructions for configuring Collaboration in CAVE for a specific site.

**Note:** Configuration only needs to be completed once; the site will pick it up in its settings.

## 27.2 Collaboration Configuration

Collaboration’s config.xml file allows for site customization of the feed and login options for a user. The “feed” refers to the chat room that replaced the nws\_collaboration room in 12Planet. The BASE file in the example below is only included as an example; the feed should be configured at a site level.

1. In CAVE, open the Localization perspective.
2. In the File Browser, navigate to **CAVE -> Collaboration -> config.xml**
3. Right click on **BASE**, and select **Copy To Site (XXX)**
  - If user does not have permission, the userRoles.xml file needs to be modified.
4. Edit the file as follows:
  - For each server that you want to add to the Server dropdown menu, add a server hostname line under **<siteConfigInformation>**.

For example: **<server hostname="<Enter Server Name>"  
prettyName="XXX Cluster"></server>**

- For each server configured, this adds a server to the Collaboration Server Login dialog as shown in Exhibit **27.2-1**.

**Collaboration Server Login**

User:

Server:

Password:

Status:

Message:

Site:  Role:

**Exhibit 27.2-1. Collaboration Server Login Dialog**

- For each site that you want to configure as a login site, add a value of `<config site="XXX">` under `<siteConfigInformation>`.
  - For each site configured, this adds a site Collaboration Server Login dialog as shown in **Exhibit 27.2-2**. **Note:** Your site should be first, followed by the sites that you back up.

**Collaboration Server Login**

User:

Server:

Password:

Status:

Message:

Site:    Role:

**Exhibit 27.2-2. Collaboration Server Login Dialog: Sites**

- For each site that you want to see in the feed when logged in as that site, add `<listEntry>XXX</listEntry>` under the previous tag.
  - The feed contains every site in the same room. However, only messages from sites that are defined using the notation above are shown in the chat window.
- Also under the `<config>` tag, for each role that you want available when logging in as that site, add `<roles><SITE ROLE></roles>`.
  - For each site configured, this adds a role to the Collaboration Site Roles dialog as shown in **Exhibit 27.2-3**.

**Exhibit 27.2-3. Collaboration Server Login Dialog: Site Roles**

- “Roles” should be similar to or the same as the usernames used in 12Planet, minus any site information (e.g., Short Term Forecaster, Long Term Forecaster).
5. Save the file by clicking the **File -> Save**.

To be more specific, see the following example as captured in the SITE config.xml file in **Exhibit 27.2-4**. **Note:** This is an example and will vary depending on your site.

```
<siteConfigInformation> // top tag
<server hostname="chat2-emix" prettyName="NCF Server"></server>
<config site="OAX"> // the site being configured, will be available for logins
<listEntry>OAX</listEntry> // users will see text in the feed from this site
<listEntry>DMX</listEntry> // users will see text in the feed from this site
<roles> Short Term Forecaster</roles> // users will have the option to login as this role
</siteConfigInformation> // end tag
```

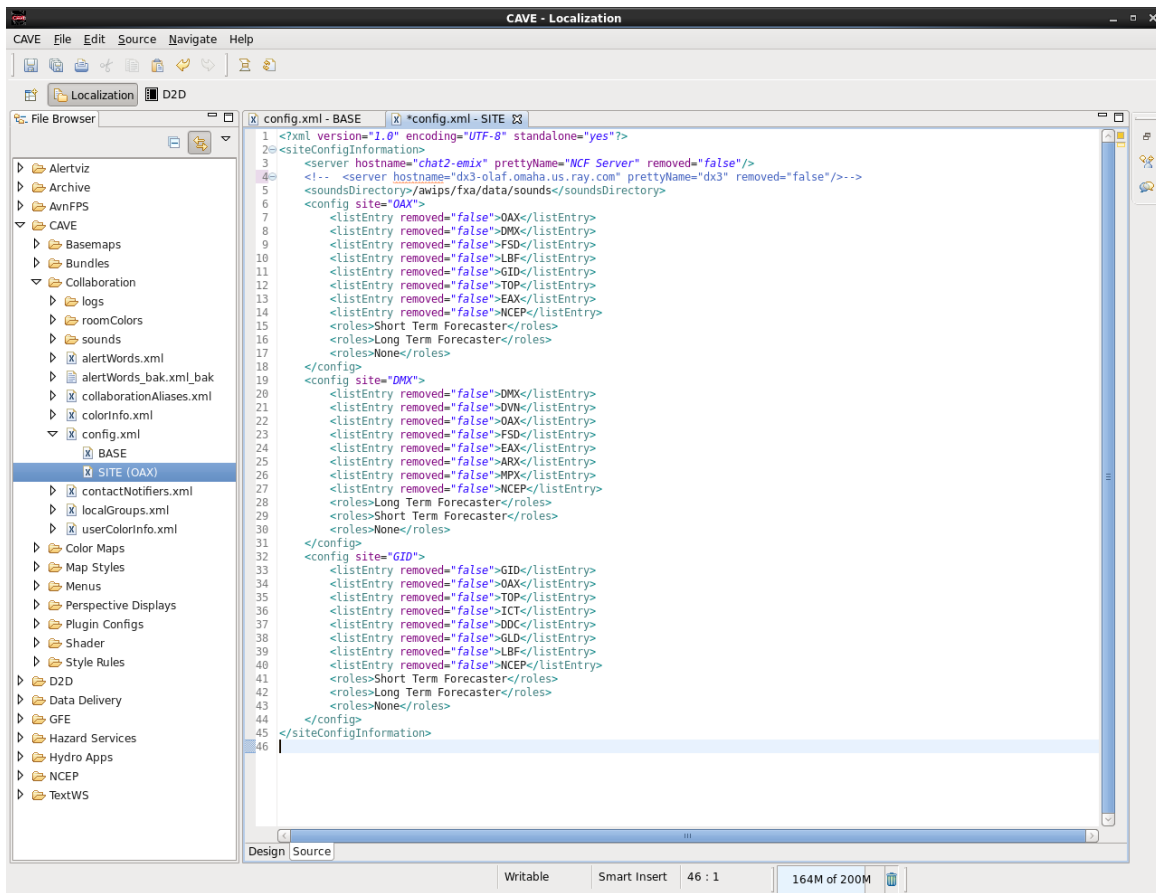

Exhibit 27.2.4. Example: Config.xml SITE File

**Chapter 28**  
**WES-2 Bridge**

## Chapter 28. WES-2 Bridge

### Table of Contents

	Page
28.1 Introduction.....	1
28.2 Installation.....	1
28.3 The EDEX-Environment Macro .....	2
28.4 EDEX Environment Configuration.....	3
28.5 EDEX Environment Management .....	4
28.6 Uninstalling AWIPS II EDEX Environment .....	5
28.7 Archive Retention .....	6
28.8 Archive Retention Dialog .....	6
28.9 Archive Retention Configuration through the Dialog.....	7
28.10 Localization Perspective Archive Directory .....	7
28.11 Localization Perspective Archive Configuration File Viewing .....	7

### List of Exhibits

Exhibit 28.2-1. A Successful awips2-edex-environment Installation.....	2
Exhibit 28.3-1. The Default Output of the awips2-edex-environment Macro.....	2
Exhibit 28.8-1. Archive Retention .....	6
Exhibit 28.11-1. Localization Perspective Archive File Viewing .....	8

### List of Tables

Table 28.4-1. edex-environment Configuration File Field Names .....	3
Table 28.4-2. Default Ports .....	3



## 28.1 Introduction

The EDEX environment is used to create additional instances of EDEX (each instance of EDEX has its own database, its own file store, its own instance of Pypies, and QPID) based on the currently installed EDEX for the purpose of running a WES-2 Bridge test case. The EDEX environment macro should be used every time a new EDEX environment is needed to run a WES-2 Bridge test case.

***You will need root access to run the EDEX environment macro, so that anyone at a WFO with root access will be able to utilize the macro.*** The EDEX environment macro will allow you to create, start, stop, and delete EDEX environment instances. A configuration file is needed to create an EDEX environment initially, and the same configuration file can be used to control the instance. The configuration file is described in this chapter.

Additionally, an EDEX environment can also be controlled by name. The EDEX environment macro should be used to configure a new EDEX environment for the WES-2 Bridge. Follow the procedures outlined in this chapter to prepare the EDEX environment to run a WES-2 Bridge test case.

**Note:** A standalone EDEX server will need to be running to allow archive data. The workstations will need to use this EDEX server. Workstations that are used to run the Archive Retention and/or Case Creation GUIs will need to mount the server's /data\_store and /archive directories.

## 28.2 Installation

**Note:** The **awips2-edex-environment** rpm must be present in the repository you will use for the installation.

To install awips2-edex-environment:

1. Log into a machine with a standalone installation of AWIPS II.  
**ssh root@adam-wes2**
2. Clear the yum cache.  
**yum clean all**
3. Install awips2-environment.  
**yum install awips2-edex-environment**

See Exhibit 28.2-1.

```

root@dev27:~
File Edit View Terminal Tabs Help
There are unfinished transactions remaining. You might consider running yum-complete-transaction first to finish them.
--> Running transaction check
--> Package awips2-edex-environment.noarch 0:12.10.1-3 set to be updated
--> Finished Dependency Resolution

Dependencies Resolved

-----
Package                Arch             Version           Repository         Size
-----
Installing:
awips2-edex-environment  noarch          12.10.1-3        common_baseline_delivery2  20 M
-----
Transaction Summary
-----
Install      1 Package(s)
Upgrade     0 Package(s)

Total download size: 20 M
Is this ok [y/N]: y
Downloading Packages:
Running rpm_check_debug
Running Transaction Test
Finished Transaction Test
Transaction Test Succeeded
Running Transaction
  Installing      : awips2-edex-environment                               1/1

Installed:
  awips2-edex-environment.noarch 0:12.10.1-3

Complete!
[root@dev27 ~]#

```

**Exhibit 28.2-1. A Successful awips2-edex-environment Installation**

### 28.3 The EDEX-Environment Macro

1. Log out of the machine that you installed awips2-edex-environment on and log back in.
2. Verify that the edex-environment macro is available.  
**edex-environment**

See Exhibit 28.3-1.

```

root@dev27:~
File Edit View Terminal Tabs Help
[root@dev27 ~]# edex-environment
Usage: edex-environment -create ${CONFIG_FILE} [--start]
       edex-environment -start { ${CONFIG_FILE} | -name ${NAME} }
       edex-environment -stop { ${CONFIG_FILE} | -name ${NAME} }
       edex-environment -remove { ${CONFIG_FILE} | -name ${NAME} }
       edex-environment --list
[root@dev27 ~]#

```

**Exhibit 28.3-1. The Default Output of the awips2-edex-environment Macro**

## 28.4 EDEX Environment Configuration

The edex-environment configuration file is a simple xml document, with this layout:

```
<?xml version="1.0" encoding="ISO-8859-1" ?>
<Wes2BridgeCase>
  <name></name>
  <dataArchiveRoot></dataArchiveRoot>
  <databasePort></databasePort>
  <edexHttpPort></edexHttpPort>
  <qpidHttpPort></qpidHttpPort>

  <jmsPort></jmsPort>
  <webPort></webPort>
  <confidentialPort></confidentialPort>
  <httpdPypiesPort></httpdPypiesPort>
  <pypiesLoggingPort></pypiesLoggingPort>
</Wes2BridgeCase>
```

Table 28.4-1 describes the field names used in the file; Table 28.4-2 describes the default ports used by the edex-environment and other AWIPS II components not configurable by edex-environment.

**Table 28.4-1. edex-environment Configuration File Field Names**

Field Name	Description
<b>name</b>	An alphanumeric character sequence used to name an edex environment. Each edex environment must have a unique name.
<b>dataArchiveRoot</b>	A directory path equivalent to the <code>DATA_ARCHIVE_ROOT</code> in <code>setup.env</code> .
<b>databasePort</b>	A numeric value representing the port that PostgreSQL should accept connections on for a particular edex environment – equivalent to the <code>DB_PORT</code> in <code>setup.env</code> . Each edex environment must have a unique databasePort.
<b>edexHttpPort</b>	A numeric value representing the port that the EDEX localization server will accept connections on – equivalent to the <code>HTTP_PORT</code> in <code>setup.env</code> . Each edex environment must have a unique edexHttpPort.
<b>qpidHttpPort</b>	A numeric value representing the QPID REST services port. Each edex environment must have a unique qpidHttpPort.
<b>jmsPort</b>	A numeric value representing the port that QPID will accept connections on – equivalent to the port specified at the end of <code>JMS_SERVER</code> in <code>setup.env</code> . Each edex environment must have a unique jmsPort.
<b>webPort</b>	A numeric value representing the port on which embedded web components (example: jetty) will listen for a connection. Each edex environment must have a unique webPort.
<b>confidentialPort</b>	A numeric value representing an additional port that must be specified for the embedded web components (example: jetty). Each edex environment must have a unique confidentialPort.
<b>httpdPypiesPort</b>	A numeric value representing the port that httpd-pypies should listen for connections on. Each edex environment must have a unique httpdPypiesPort.
<b>pypiesLoggingPort</b>	A numeric value representing the port that the pypies logger should accept connections on. Each edex environment must have a unique pypiesLoggingPort.

Table 28.4-2. Default Ports

Name	Default Ports Used by edex-environment
databasePort	5432
edexHttpPort	9581
qpIdHttpPort	8180
jmsPort	6572
webPort	8080
confidentialPort	8443
httpdPypiesPort	9582
pypiesLoggingPort	9020
Name	Default Ports Used by Other AWIPS II Components Not Configurable by edex-environment
dataDelivery	9588 and 10144
ncfBandwidthMgr	9590

## 28.5 EDEX Environment Management

Only a user with root privileges is able to manage EDEX environments.

In the example commands below:

- *\${CONFIG}* refers to a configuration file on the filesystem.
- *\${NAME}* refers to the name of an EDEX environment.

### Creating an EDEX Environment

Before you can create an edex environment, you will need to create a configuration file (Refer to Section 28.3 of this chapter).

Run the following command to create an EDEX Environment:

```
edex-environment -create ${CONFIG}
```

### Starting an EDEX Environment

There are two ways to start an EDEX environment. One way is to run the following command to start an EDEX environment based on the configuration file that was used to create it:

```
edex-environment -start ${CONFIG}
```

You can also, optionally, start an EDEX environment by name:

```
edex-environment -start -name ${NAME}
```

You cannot start an EDEX environment that does not exist.

### *Stopping an EDEX Environment*

There are two ways to stop an EDEX environment. One way is to run the following command to stop an EDEX environment based on the configuration file that was used to create it:

```
edex-environment -stop {CONFIG}
```

You can also, optionally, stop an EDEX environment by name:

```
edex-environment -stop -name {NAME}
```

You cannot stop an EDEX environment that is not running, and you cannot stop an EDEX environment that does not exist.

### *Deleting an EDEX Environment*

There are two ways to delete (remove) an EDEX environment. One way is to run the following command to delete an EDEX environment based on the configuration file used to create it:

```
edex-environment -remove {CONFIG}
```

You can also, optionally, delete an EDEX environment by name:

```
edex-environment -remove -name {NAME}
```

You cannot delete an EDEX environment that does not exist. Deleting an EDEX environment while it is still running is not recommended.

### *Viewing All Available EDEX Environments*

To view a list of available EDEX environments, run the following command:

```
edex-environment -list
```

## **28.6** *Uninstalling AWIPS II EDEX Environment*

To uninstall awips2-edex-environment, complete the following steps:

1. Log into the machine that awips2-edex-environment has been installed on:

```
ssh root@adam-wes2
```

2. Remove awips2-edex-environment

```
yum remove awips2-edex-environment
```

3. Clean up any files that remain.

```
rm -rf /awips2/edex-environment
```

```
rm -rf /usr/local/edex-environment
```

## 28.7 Archive Retention

Archive Retention is the management of data deletion (purging) from the file system. It is defined by configuration files stored in the EDEX Localization subsystem. The configurations can be edited through the Archive Retention Dialog, which is accessible through the menu CAVE > Archive Retention..., or manually by editing the XML configuration file through the CAVE Localization Perspective. Manual edit is **not recommended**.

Permission to access Archive Retention and Case Creation is under the control of AWIPS User Administration. It is controlled under the component “Data Archiving.”

A quartz cron timer runs the Archive Purger. This timer is a configurable property in the `/awips2/edex/conf/resources/com.raytheon.uf.edex.archive.cron.properties` file.

**archive.purge.cron=0+5+0/3+\*+\*+?**

This is the delivered baseline value, which configures it to run once every 3 hours.

To enable the purger in the same file,

**archive.purge.enable=true**

## 28.8 Archive Retention Dialog

The Archive Retention dialog (shown in Exhibit 28.8-1) is the configuration GUI for visual editing of the data retention XML configuration files.

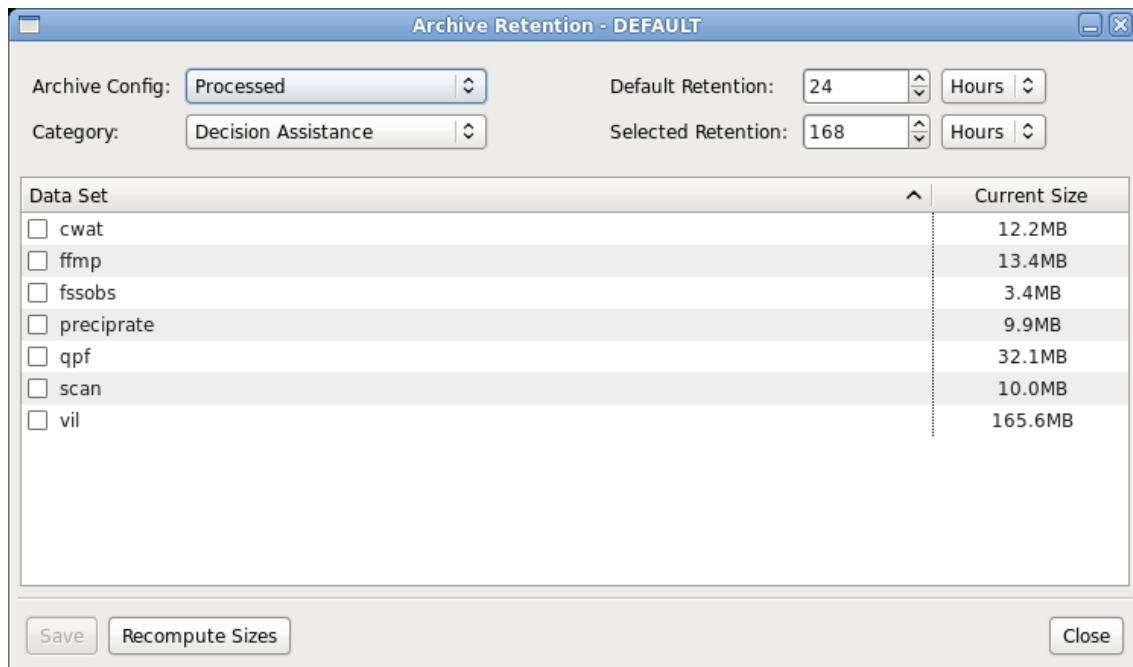

**Exhibit 28.8-1. Archive Retention**

### 28.9 *Archive Retention Configuration through the Dialog*

The purge times of Archive Data and Data Store files are configured by the Archive Retention Dialog. From top to bottom, the Archive Retention Configuration Dialog is divided into three sections. Use the top section of the dialog to select the **Archive** configuration, a specific **Category** for that Archive configuration, a **Default Retention** for the Archive, and an **Selected Retention** value for any table items selected in the Category element table (the middle section, described below). The Retention values can be entered and displayed in **Hours** or **Days** by selecting either value from the selection box. The retention time indicates how long a data file is retained before the Archive Purger deletes it.

The middle section contains a table that displays the possible **elements** of the currently selected Category in the Archive. The rows for each element are made up of a check box, a **Data Set**, and the **Current Size**. Checking the box next to the Data Set indicates that the Extended Retention value applies to the data related to that row. Current size is populated by a background thread and may not be immediately available. If it is not yet calculated, then “????” is displayed instead.

The bottom section is for saving a configuration change for the current Archive. It has **Save**, **Recompute Sizes**, and **Close** buttons. The Save button is activated only if changes are made in the UI to the configuration. Changes are saved when the Save button is clicked. (The changes are saved to a SITE level file.) The dialog closes when the Close button is clicked. Computing the sizes is a slow process. Once the size is computed for a category’s row, it is not recalculated even if the underlying directory structure changes. Clicking on the **Recompute Size** button will reset all values to “unknown,” which will then restart a background job to redetermine the sizes for the Data Sets. Basically it updates the row sizes in the Archive Case Creation dialog.

### 28.10 *Localization Perspective Archive Directory*

The data retention XML configuration files can be viewed through the CAVE Localization perspective in an Archive icon folder.

### 28.11 *Localization Perspective Archive Configuration File Viewing*

Archive configuration files can be viewed in the CAVE Localization Perspective under Archive > Archive. Each XML configuration file defined for Archive Retention is listed under the second Archive folder dropdown.

Two files are delivered with AWIPS II: **PROCESSED\_DATA.xml** and **RAW\_DATA.xml** (as shown in the middle screen of Exhibit 28.11-1). In the delivered configuration, these files are located in `/awips2/edex/data/archive`. The file `PROCESSED_DATA.xml` is the configuration for retention of Archiver output files. `RAW_DATA.xml` is for the ingest directory `/data_store`. Each of these delivered XML

configuration files has a header that explains how they are written and how a user can add elements to them.

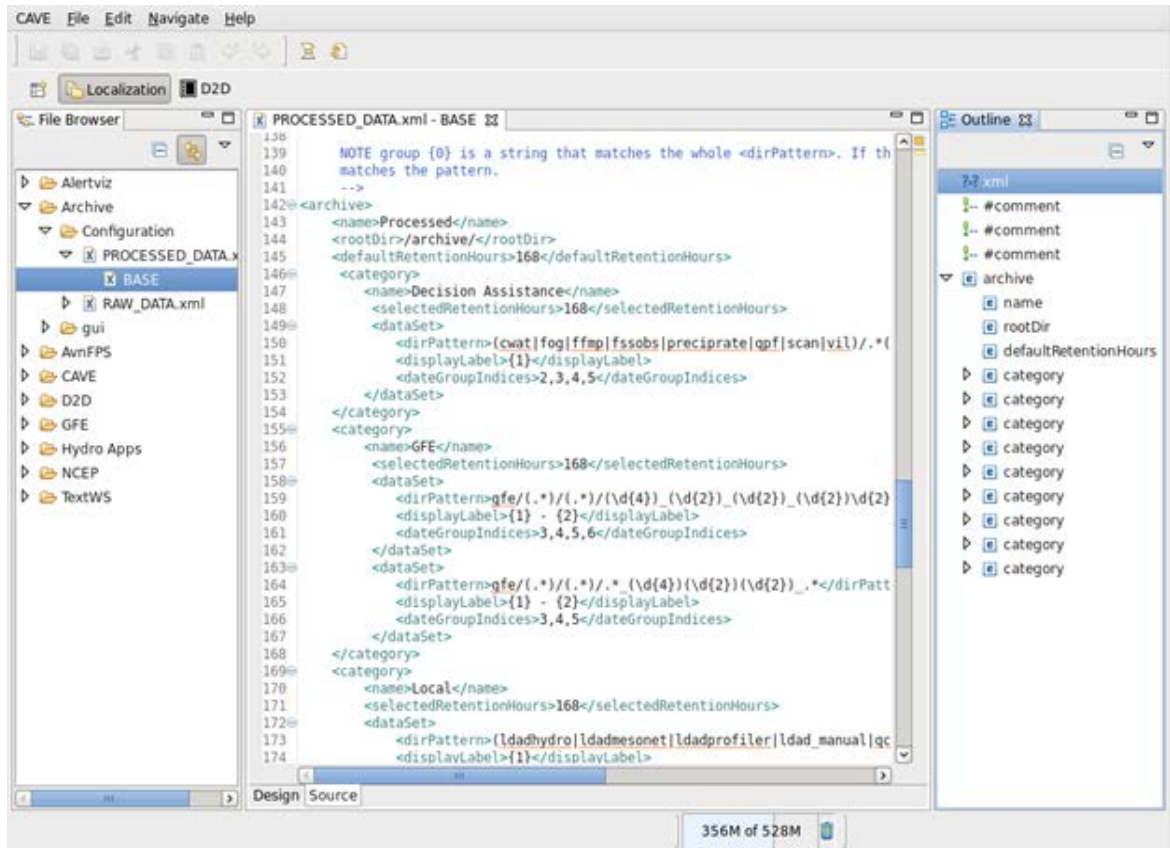

**Exhibit 28.11-1. Localization Perspective Archive File Viewing**



**Chapter 29**  
**Data Delivery System**  
**Administrator's Guide**

## Chapter 29. Data Delivery System Administrator’s Guide

### Table of Contents

	<i>Page</i>
Chapter 29 Data Delivery System Administrator’s Guide .....	1
Table of Contents .....	i
29.1 General Data Delivery Administrative Functions .....	1
29.1.1 Simple Start and Stop.....	1
29.1.2 Configure a Proxy if Necessary .....	1
29.1.3 Registry Configuration.....	2
29.1.4 Registry Federation Configuration .....	6
29.1.5 Web Registry Federation Configurations .....	8
29.2 Configuration of Data Delivery .....	12
29.2.1 Harvester Configuration.....	12
29.2.2 OPeNDAP Service Configuration .....	14
29.2.3 Bandwidth Manager Configuration .....	15
29.2.4 Model/Level Lookup Configurations .....	16
29.2.5 Unit Configurations .....	17
29.2.6 Data Set Information Lookup .....	18
29.2.7 Registry User “Roles” definition .....	22
29.3 Monitoring (Notification) and Statistics.....	22
29.3.1 Registry Statistics.....	23
29.3.2 Subscription/Data Retrieval Statistics.....	23
29.3.3 System Management.....	24
29.4 FAQ .....	27

Data Delivery has been implemented into the AWIPS II baseline for Initial Operating Capability (IOC) 0 to provide access to data that is independent of its location (that is, data that is not resident locally at a Weather Forecast Office, River Forecast Center, or National Center).

Data Delivery gives users the ability to create queries (One Time Requests) and subscriptions to data sets provided by the NOAA Operational Model Archive and Distribution System (NOMADS) data provider.

## **29.1 General Data Delivery Administrative Functions**

### **29.1.1 Simple Start and Stop**

There are two different scripts to start the registry, and the script that gets executed depends on whether or not you are at the NCF (Central Registry), which runs the Crawler/Harvester, or an intermediary or node registry.

Running the following script starts the registry for a WFO or intermediary.

```
/etc/init.d/edex_camel start registry
```

Running the following script starts the registry for the NCF along with the Crawler/Harvester.

```
/etc/init.d/edex_camel start centralRegistry
```

### **29.1.2 Configure a Proxy if Necessary**

In the event your network is located behind a web proxy, a proxy configuration file is available for configuration.

This file is located in the following directory.

```
$EDEX_HOME/data/common_static/configured/$SITE/datadelivery
```

In the case of a Thin Client user, the configuration of the proxy is done from the EDEX server you are connecting to, not from your local network. No configuration on your side should be necessary.

Here is an example using the Omaha Raytheon network setup.

```
# Uncomment the lines below and enter the correct values to enable the use
# of a proxy
http.proxyHost=proxy.ext.ray.com
http.proxyPort=80
```

If your site is not located behind a proxy, comment the above lines out and no web proxy will be used in the HTTP connections for Data Delivery crawler and retrieval connections.

The configuration of a web proxy and other configuration files, that have been consolidated in the “/awips2/edex/conf/resources” directory. The proxy configuration file is called the “proxy.properties” as before and has the same format.

Example...

```

http.proxyHost=proxy.ext.ray.com
http.proxyPort=80
http.nonProxyHosts=*.oma.us.ray.com

https.proxyHost=
https.proxyPort=

ftp.proxyHost=
ftp.proxyPort=
ftp.nonProxyHosts=

socksProxyHost=
socksProxyPort=
socksProxyVersion=
java.net.socks.username=
java.net.socks.password=

```

### 29.1.3 Registry Configuration

Data Delivery as of OB14.2.1 is fully federated. The Data Delivery federation is comprised of a “Modified Spoke and Wheel” design. The federation is described as being “Modified” because in actual implementation there are mid-tier registries at the regional HQ's and elsewhere that act as intermediates between the central registry and the leaf nodes. This has the benefit of reducing direct traffic to the Central Registry located at the NCF. In the federation design, the Harvester only runs at the Central Registry. As a result, the WFO's no longer need to be concerned with the configuration of the Harvester. The NCF (Central Registry) handles the maintenance of the Crawler.

Data Delivery employs HTTPS secure transfers for registry to registry and some provider to registry communications. This means that Certificates for each registry node that directly connects to another registry node must be loaded into the trust store of each connecting node. This can be accomplished using a new utility located in the “/awips2/edex/conf/security” directory. The tool is called the keystoreUtil.sh.

### Creating your certificate for export

- You can create your certificate for export by typing `./keystoreUtil.sh -g`. The script will automatically determine the WFO (CWA) of your Data Delivery server from the `setup.env ClusterID` environment variable. Input the passwords for the Public Key and Keystore when prompted. Please, make sure you remember these passwords! When prompted for whether or not to trust this certificate say “yes”. The script will complete and create a file (named by your ClusterID) that can be copied over to other nodes that your federation node will directly interface with (Central Registry most likely).

Example, `OAXPublicKey.cer`.

### Adding another certificate to your keystore.

- You can add other federation nodes certificates to your local Keystore. It will be necessary for replication to/from the Central Registry (A/BNCF), or any other federation your Data Delivery system may be joining. The command, `./keystoreUtil.sh -a ${CertificateFileName}` will add a certificate for another federation node. You will be prompted for the “Alias” of this certificate. Use the WFO/ClusterID of the Data Delivery node for this field. Example, “OAX” for OAX if that is the node you are connecting to. There are two notable exceptions to this rule. The Data Provider Agent for MADIS data will be known as “DPA” (Only added at Central Registry). If the node being added is the Central Registry, the Cluster ID is then “NCF”. Next, you will then be prompted for your Keystore password, input the correct value. Finally, type “yes” when prompted for adding this to the trust store. The certificate will then be added and communications between that node and yours can commence.

### Some things to consider in review

- If you have a new Data Delivery node you must make sure that your Certificate has been added to the Keystore of the Central Registry you are connecting too. Also, you must have the public key (Certificate) of the Central Registry you are replicating too added to your local Keystore. Both must be in place before replication will commence.

### Updated configuration files

Another configuration file of note new (starting 14.4.1) is the “`security.properties`”. It is also located in the “`/awips2/edex/conf/resources`” directory but under the further directories of “`/site/${SITE}`”

Where, `${SITE}` is your local WFO/ClusterID. It is written by the “`keystoreUtil.sh`” and is read by the running system to gather each federation nodes SSL credentials for communicating with other nodes. Manual editing of this file should be unnecessary.

Example...

```
#The following configuration items are used with the wss4j in/out interceptors
org.apache.ws.security.crypto.merlin.keystore.file=security/keystore.jks
org.apache.ws.security.crypto.merlin.keystore.password=
org.apache.ws.security.crypto.merlin.keystore.type=JKS
org.apache.ws.security.crypto.merlin.keystore.alias=OAX
```

An import registry configuration file is the  
“com.raytheon.uf.edex.registry.ebxml.properties”.

The user editable features in this file mainly are the “federation enabled” flag and the “ebxml registry host” field. In most cases these can be set once and not touched again. In the off -hand chance the registry host is on another machine other than the Data Delivery install. You may need to edit the host field. Example...

```
# The period which registry replication occurs
ebxml-replication-process.cron=0/10+*+*+*+*+?

# The period which the registry runs the garbage collection
ebxml-garbage-collect-process.cron=0+0+0/1+*+*+?

# When a federation synchronization is necessary, this is the number of threads
# that will be used for synchronization
ebxml-federation-sync-threads=3

# Master switch enabling email transmission
ebxml-email.enabled=false

# The maximum number of events that will be batched and send
# in a registry replication notification
ebxml-notification-batch-size=200

# The maximum number of threads that the ebxml registry will use for processing
web requests

# This number must be >=5. As a general rule, the maximum number of
connections should be:

# 5+{registries this registry is replicating to/from}=max-threads
ebxml-webserver-max-threads=8

# EBXML thrift service port
```

```

ebxml.thrift.service.port=9588

ebxml.thrift.service.properties=disableStreamCache=true&chunked=false&httpBindingRef=#binaryHttpBinding&matchOnUriPrefix=true

# EBXML webservice port

ebxml.registry.webservice.port=8082

# EBXML registry host

ebxml.registry.host=localhost

# EBXML federation enable flag

ebxml.registry.federation.enabled=false

# EBXML registry webservice home

ebxml.registry.webservice.home=/awips2/edex/webapps/registryEbxml/

#####

# Registry Web server IP access control configurations
# This is a ; delimited list of IP access configurations
#
#An empty white list is treated as match all. If there is at least one entry in the
white list,
#then a request must match a white list entry. Black list entries are always
applied, so that
#even if an entry matches the white list, a black list entry will override it.
#
#Internet address specification is separated from the URI pattern using the "|"
(pipe) character.
#URI patterns follow the servlet specification for simple * prefix and suffix wild
#cards (e.g. /, /foo, /foo/bar, /foo/bar/*, *.baz).
#
#Examples of the entry specifications are:
#
# 10.10.1.2 - all requests from IP 10.10.1.2
# 10.10.1.2|/foo/bar - all requests from IP 10.10.1.2 to URI /foo/bar

```

```

# 10.10.1.2/fo/* - all requests from IP 10.10.1.2 to URIs starting with /foo/
# 10.10.1.2|*.html - all requests from IP 10.10.1.2 to URIs ending with .html
# 10.10.0-255.0-255 - all requests from IPs within 10.10.0.0/16 subnet
# 10.10.0.-255/fo/bar - all requests from IPs within 10.10.0.0/16 subnet to
URI /fo/bar
# 10.10.0-3,1,3,7,15/fo/* - all requests from IPs addresses with last octet equal
to 1,3,7,15 in subnet 10.10.0.0/22
# to URIs starting with /foo/ 10.10.0.0/22 to URIs starting with /foo/
#
ebxml-webservice-ip-whitelist=
ebxml-webservice-ip-blacklist=[root@dev11 resources]# ^C

```

Some files in resources have specific relevance to particular federation members. The “dpa.properties” files is specific to the MADIS data provider agent. It is only configured and used at that location. It contains the FQDN of the central registry host and protocol specific information about accessing it. Example.

```

# configuration properties for DPA to central registry
registry.host=localhost
ebxml.registry.webservice.port=8082
ebxml.registry.protocol=http s

```

The “ftp.properties” is another file having a specific relevance. It sets the protocol specific temporary download directory for FTP based data providers in Data Delivery. It has no use until those data providers become available. (PDA will use this). It will be used by all federation members except data providers. Example...

```

ftp.workDirectoryPath=/tmp
ftp.timeout=5000

```

#### **29.1.4 Registry Federation Configuration**

The following files must be present for a NCF registry to participate in the federation and receive replicated objects:

##### **federationConfig.xml**

- Located at:  
/awps2/edex/data/utility/edex\_static/ebxml/federation/federationConfig.xml



- This describes attributes of the registry that must be present so a registry may participate in a federation
- A sample of this file is provided below.

```
<?xml version="1.0" encoding="UTF-8" standalone="yes"?>
<federationProperties>
  <conformanceProfile>RegistryFull</conformanceProfile>
  <specificationVersion>4.0</specificationVersion>
  <catalogingLatency>PT0.000S</catalogingLatency>
  <replicationSyncLatency>PT0.000S</replicationSyncLatency>
  <siteIdentifier>NCF</siteIdentifier>
  <siteDescription>AWIPS Network Control Facility</siteDescription>
  <sitePrimaryContactFirstName>National</sitePrimaryContactFirstName>
  <sitePrimaryContactMiddleName>Weather</sitePrimaryContactMiddleName>
  <sitePrimaryContactLastName>Service</sitePrimaryContactLastName>
  <siteAddressStreetNumber>1325</siteAddressStreetNumber>
  <siteAddressStreet>East West Highway</siteAddressStreet>
  <siteAddressCity>Silver Spring</siteAddressCity>
  <siteAddressState>MD</siteAddressState>
  <siteAddressCountry>USA</siteAddressCountry>
  <siteAddressPostalCode>20910</siteAddressPostalCode>
</federationProperties>
```

### notificationServers.xml

Designated by Data Delivery ID, the file designates the registries that the local registry wishes to send/receive notifications to/from. The communication between registries is bidirectional. An example is as follows

```
<NotificationServers>
  <registry>DataDelivery ID</registry>
</NotificationServers>
```

### setup.env

- The setup.env file is located at /awips2/edex/bin
- Change the NCF\_HOST to be the IP address of the server acting as the NCF server
- Change the DATADELIVERY\_HOST to be the your ip address (it CANNOT be localhost)
- Enable the federation flag
- The configuration items should be configured as follows (change addresses accordingly):

```
export AW_SITE_IDENTIFIER=OAX (Can be any valid ID)
export CLUSTER_ID=NCF
export NCF_ADDRESS=http://dx4-spike.oma.us.ray.com:8084
```

```
export DATADELIVERY_HOST=147.18.136.21
export EBXML_REGISTRY_FEDERATION_ENABLED=true
```

## Registry Federation Configuration at WFO differences

The following files must be present for a WFO registry to participate in the federation and receive replicated objects:

**federationConfig.xml:** Same as NCF setup

**notificationServers.xml:** Same as NCF setup

### setup.env

- The setup.env file is located at /awips2/edex/bin
- Change the NCF\_HOST to be the IP address of the server acting as the NCF server
- Change the DATADELIVERY\_HOST to be the your IP address (it **CANNOT** be localhost)
- Enable the federation flag
- The configuration items should be configured as follows (change addresses accordingly):

```
export AW_SITE_IDENTIFIER=OAX (Can be any valid ID)
export CLUSTER_ID=OAX
export NCF_ADDRESS=http://dx4-spike.oma.us.ray.com:8084

export DATADELIVERY_HOST=147.18.136.21
export EBXML_REGISTRY_FEDERATION_ENABLED=true
```

### 29.1.5 Web Registry Federation Configurations

Each registry has a REST service endpoint that you can navigate to and administer via a web interface.

The interface is available at:

[http://{\\$Registry\\_Host\\_Name}:8082/registry/RegistryInterface.html](http://{$Registry_Host_Name}:8082/registry/RegistryInterface.html)

The registry web interface provides several convenient interfaces for interacting with the data delivery registry. These are primarily used for developmental and testing purposes. The registry interface can be accessed by directing a web browser at port 8082 on the server running the registry.

The registry web interface currently contains four sections. Each section may be accessed by using the menu in the left pane of the registry web interface.

The first interface is the Query Manager Interface shown in **Exhibit 29.1.5-1**. The Query Manager Interface provides a convenient way of executing queries via the Query Manager as defined in Section 2 of the OASIS ebXML RegRep 4.0 Services and Protocols specification (ebRS 4.0). With the exception of the Return Request configuration item, all other configurations items are defined and explained in the ebRS 4.0 document in Section 2.2.1.3. If set to true, the Return Request item will instead return the request that will be submitted to the query manager as opposed to the response from executing the request.

The screenshot shows a web form titled "Query Manager Interface". It contains several configuration fields:

- Return Request: A dropdown menu set to "False".
- Response Option: A dropdown menu set to "Object Ref".
- Depth: An empty text input field.
- Federated: A dropdown menu set to "False".
- Federation: An empty text input field.
- Format: An empty text input field.
- Language: An empty text input field.
- Match Older Versions: A dropdown menu set to "False".
- Max Results: An empty text input field.
- Start Index: An empty text input field.
- Query Type: A dropdown menu set to "AdhocQuery".
- queryLanguage: An empty text input field.
- queryExpression: An empty text input field.

At the bottom of the form is a "Submit" button.

**Exhibit: 29.1.5-1: Query Manager Interface**

The Query Type drop down menu contains the Canonical Queries defined in Sections 2.3-2.21 of ebRS 4.0. It also contains any custom user defined queries. Selecting a query type will cause the menu to dynamically update to contain parameters specific to the selected query type. After all items are configured, the submit button may be pressed to send the request to the registry. The query response will be displayed in the bottom frame of the page.

The second interface is the Define Query Interface. This interface is separated into two sections. The first section allows the user to select any previously defined queries and remove them. This is shown in Exhibit 29.1.5-2.

**Remove Custom Query Definition**

Query Name

**Exhibit 29.1.5-2: Remove Custom Query Definition**

The second section allows the user to define a custom query for use with the registry query manager. As shown in Exhibit 29.1.5-3, the user inputs a query name, description, the query language this query is written in, and the actual query expression. Currently, HQL is the only supported query language.

**Define New Query Definition**

**Query Definition**

Query Name

Query Description

Query Language

Query Expression

**Exhibit 29.1.5-3: Define New Query Definition**

Parameters may also be defined for the query and specified using the interface shown in Exhibit 29.1.5-4.

Once a query has been defined and saved to the registry, the query can be tested through the query manager interface.

**Query Parameter Definition**

Name

Description

Data Type

Default Value

Min Occurrences

Max Occurrences

**Exhibit 29.1.5-4: Query Parameter Definition**

The third section of the registry web interface is the Subscription Backup section shown in **Exhibit 29.1.5-5**. This page is used for manually backing up and restoring subscriptions.

**Backup/Restore Data Delivery Subscriptions**

**Exhibit: 29.1.5-5: Backup/Restore Data Delivery Subscriptions**

A user may backup one subscription by inputting the subscription id and pressing the Backup subscription button or a user may back up all subscriptions using the Backup All Subscriptions button. Likewise, with the Restore subscription and Restore Subscriptions buttons, a user may restore one or all previously backup up subscriptions. If a user chooses not to restore previously backed up subscriptions, they may use the clear backup files button to delete the backed up subscriptions from the file system.

The final section of the Registry Web Interface is the federation status page. This page is used to view the status of the registry federation. This interface is currently divided into four sections.

The first section, as shown in Exhibit 29.1.5-6, gives basic status information about this registry, such as the data delivery ID, the site ID, if this registry is participating in the federation, and which other registries are being replicated to/from.

Federation Status	
Data Delivery ID:	OUN
Site ID:	OUN
Federated:	true
Replicating To:	NCF
Replicating From:	NCF

**Exhibit 29.1.5-6: Federation Status**

The second section of this interface, shown in Exhibit 29.1.5-7, allows the user to execute several operations on the registry. Using the drop down boxes, a user may synchronize this registry's data with a remote registry, subscribe to a remote registry or unsubscribe from a remote registry.

Synchronize With:	DMX	Sync
Subscribe To:	DMX	Subscribe
Unsubscribe From:	NCF	Unsubscribe

**Exhibit 29.1.5-7: Synchronizing Registry's Data**

The last two sections of the federation status page simply display the registries that are participating in the federation as well as which object types are currently being replicated.

## 29.2 Configuration of Data Delivery

### 29.2.1 Harvester Configuration

The IOC 0 configuration of Data Delivery contains a web crawling harvester that finds potential data sets and submits them to the Registry for storage. There are many configurable pieces to this harvester, the first of which is the timing for when a crawler will be triggered to reach out to its provider and begin harvesting data. This is controlled by two crontab-like entries located in each harvester's provider-specific configuration file. At install, these files by default are located in

\$EDEX\_HOME/data/common\_static/base/datadelivery/harvester.

Under this directory, you will notice the NOMADS provider-specific file. The NOMADS file is the only operational provider. If this is the first time you have run Data Delivery or if you have done a complete fresh installation, these files will need to be updated. If you have run IOC 0 versions of Data Delivery before, you will need to edit the files in the \$SITE localization level. They are the ones that are read in an operational state by Data Delivery. The base level files are merely used as starting points and are copied with local alterations to the \$SITE localization after the first Seed Scan is performed. (It is generally after a day’s worth of operation.)

Open the file in an editor of your choice and look for the two entries that look like crontab.

```
<seedScan>0 0 0 * * ?</seedScan>
<mainScan>0 \12 * * * ?</mainScan>
```

A “Seed Scan” is a periodic total check of the provider site. It is done to check for new and/or updated data sets. The general rule is to set the Seed Scan to occur once daily – if possible, at a relatively quiet time of operation. If data on the provider changes very little over time, the scan can be set to occur less frequently (as little as once monthly if directed).

The “Main Scan” is the scan that finds and directs data sets to the registry for handling. In testing, it was determined that it takes, on average, less than 12 minutes to perform a complete scan of all data set collections on the NOMADS provider site. Hence, the scans are timed to happen 12 minutes apart, 3 times per hour by default. The frequency, however, is left to your discretion. One scan per hour may actually be sufficient. Most of the XML tags in this document are tunable, although some are not. The list of tunable parameters and what they do is available in Table 29.2.1-1

**Table 29.2.1-1. Harvester Tunable Parameters and Purpose**

Tunable Parameters	Purpose
<code>&lt;timeBetweenCrawlRequests&gt;500&lt;/timeBetweenCrawlRequests&gt;</code>	Represents a delay between crawl requests in milliseconds. It is done as a courtesy to the provider so as not to act like a Distributed Denial of Service (DDoS) attack when browsing the website. It avoids locking up all available bandwidth both to the site and from the client.
<code>&lt;postedFileDelay&gt;3 HOURS&lt;/postedFileDelay&gt;</code>	A delay designed to allow temporal comparisons for files that traverse the day boundary.
<code>&lt;ignore&gt;GDAS-BUFR&lt;/ignore&gt;</code>	Used to designate data set collections on a provider site that you wish to ignore. If you place a collection title in as an “ignore,” then the crawler will not crawl anything containing that string in its URL. This is very useful for completely ignoring data sets that have no value to you. Find a string of characters that are unique to that data set and place it in an ignore tag and it will never be crawled again. Several examples of this in the active NOMADS configuration are the “rap_f” and “ruc” ignores. One ignores data sets that contain the character string “rap_f.” The other has the consequence of ignoring an entire model

Tunable Parameters	Purpose
	family, "ruc".
<code>&lt;useRobots&gt;true&lt;/useRobots&gt;</code>	Signifies to the crawler agent that this provider site has a "Crawler configuration" available. This means that the site has a set of rules that allow the crawling agent to correctly traverse the site according to its rules. NOMADS has a robots.txt. You may encounter providers that do not have this feature.
<code>&lt;collection projection="LatLon"   dataType="Grid" ignore="false"   name="NCEP_GFS" &gt;   &lt;seedUrl&gt;NCEP_GFS&lt;/seedUrl&gt;   &lt;urlKey&gt;&lt;/urlKey&gt;   &lt;periodicity&gt;day&lt;/periodicity&gt;   &lt;firstDate&gt;20080905&lt;/firstDate&gt;   &lt;lastDate&gt;20121108&lt;/lastDate&gt;   &lt;dateFormat&gt;yyyyMM/yyyyMMdd&lt;/dateFormat&gt; &lt;/collection&gt;</code>	The Collections themselves have a couple of parameters that you can alter manually. The "ignore" attribute can be set to true if you wish to ignore this configured data set collection. You can also alter the "lastDate." On occasions where out-of-cycle or irregular updates occur, it can sometimes make the difference between a data set being available and not being recognized. In normal running for the NOMADS provider, these can be left alone.
<code>&lt;ingestNew&gt;true&lt;/ingestNew&gt;</code>	If you recognize a new collection during a Seed Scan, 'Should I set ignore to false and allow Main Scan's to pick up data sets for it?'. Default for a newly discovered collection is "true". This means that a new collection discovered during a Seed Scan will automatically be added to the collection list in the Main Sequence Scan and scanned on the schedule of the Main Sequence Scan.
<code>&lt;maxSeedDepth&gt;-1&lt;/maxSeedDepth&gt;</code>	Sets the seed scan directory traversal depth. -1 means unlimited.
<code>&lt;maxSeedPages&gt;-1&lt;/maxSeedPages&gt;</code>	Sets the seed scan max number of pages traversed. -1 means unlimited.
<code>&lt;maxMainDepth&gt;2&lt;/maxMainDepth&gt;</code>	Sets the main scan directory traversal depth. -1 means unlimited.
<code>&lt;maxMainPages&gt;1000&lt;/maxMainPages&gt;</code>	Sets the main scan max number of pages traversed. -1 means unlimited.

### 29.2.2 OPeNDAP Service Configuration

The IOC 0 configuration of Data Delivery contains a configuration file for the OPeNDAP service. This file is located in the directory `$EDEX_HOME/data/common_static/base/datadelivery/harvester`.

The file, which is named `OPeNDAPServiceConfig.xml`, contains a list of GrADS Data Server (GDS, formerly known as GrADS-DODS server) constants and specific dataset overrides that are used by the harvester Metadata Handler in processing OPeNDAP derived gridded data. Some of the tags are specific to data set names, and others are more for the purpose of searching for a particular collection type. Most of the information contained in this file is specific to connecting to the NOMADS GrADS Data server. The constants in particular are for that purpose, and very little configuration is necessary for this file.



### 29.2.3 Bandwidth Manager Configuration

The AWIPS II Data Delivery server comes equipped with an engine for managing and parceling out bandwidth to subscription retrievals. Most of this system is transparent to the user. However, some portions are exposed to configuration. The main Bandwidth configuration file is the bandwidthmap.xml.

```
<?xml version="1.0" encoding="UTF-8" standalone="yes"?>
<!-- bandwidth is specified in kilobytes/second (kB/s) -->
<bandwidthMap>
  <route planDays="2" network="OPSNET" defaultBandwidth="768"
        bucketSizeMinutes="3" />
</bandwidthMap>
```

The relevant features here are the “planDays,” which indicate how far out the Bandwidth Manager will schedule. The network, in this case, is OPSNET (the other possibility is “SBN”). The <defaultBandwidth> is the amount of bandwidth the manager will allocate for Data Delivery retrieval traffic. The <bucketSizeMinutes> is the size of the window used to compute the amount of traffic in kB/s for that given number of minutes. So subscriptions or ad hoc requests coming due in a window (bucket) are considered for sizing into those windows (buckets) it will take to complete the retrieval while staying below the default Bandwidth limit. Another consideration in this equation is the priority. Lower-priority Subscriptions will be shifted further into the future and considered after Higher-priority Subscriptions for a given “bucket.” The Bandwidth Manager will continue to shift subscriptions further into the future until they exceed the allowable Latency tolerance, the final consideration in the bandwidth usage. Latency can be specifically set up for that subscription, model, user, etc. Custom Latency rules are saved in the following file.

**~common\_static/site/\$SITE/datadelivery/systemManagement/rules/latencyRules.xml**

This is an example of a latency rule. Note that the latency is measured in minutes.

```
<?xml version="1.0" encoding="UTF-8" standalone="yes"?>
<latencyRules>
  <rule xmlns:xsi="http://www.w3.org/2001/XMLSchema-instance"
        xsi:type="latencyRuleXML">
    <ruleName>GFS 1.0 latency rule</ruleName>
    <ruleField>gfs</ruleField>
    <ruleOperator>Like</ruleOperator>
    <ruleValue>GFS</ruleValue>
    <latency>30</latency>
  </rule>
</latencyRules>
```

When you create a new Subscription/Ad hoc request that exceeds the configured latency rules, you can elect to have the retrieval exceed the allowable rules and still execute. Then, if available bandwidth is available in some other window in the future, your retrieval will be executed. The administration and maintenance of the Latency and other

Bandwidth functions are available through the Data Delivery System Management GUI interface. It is located under the Data Delivery header of the CAVE menu.

#### 29.2.4 Model/Level Lookup Configurations

In the Data Delivery EDEX configuration, it was necessary to have Gridded parameter translations and level lookups to connect effectively to the NOMADS GrADs server. For IOC 0, a standard set of parameter lookup XML files is contained in the `$EDEX_HOME/data/common_static/base/datadelivery/lookups` directory. All of the model/groups currently hosted on the NOMADS site have a corresponding lookup file. In the event NOMADS adds model/group additions to NOMADS, new parameter configuration entries are auto-generated by the crawler upon discovery.

A sample model/group lookup follows. (This is an example from RTMA model.)

```
<?xml version="1.0" encoding="UTF-8" standalone="yes"?>
<ParameterLookup>
  <parameterConfig AWIPS="tmp2m" GrADs="tmp2m"/>
  <parameterConfig AWIPS="spfh2m" GrADs="spfh2m"/>
  <parameterConfig AWIPS="P" GrADs="pressfc"/>
  <parameterConfig AWIPS="wind10m" GrADs="wind10m"/>
  <parameterConfig AWIPS="vgrd10m" GrADs="vgrd10m"/>
  <parameterConfig AWIPS="wdir10m" GrADs="wdir10m"/>
  <parameterConfig AWIPS="ugrd10m" GrADs="ugrd10m"/>
  <parameterConfig AWIPS="dpt2m" GrADs="dpt2m"/>
</ParameterLookup>
```

The default for a new parameter is to have the AWIPS and GrAD names the same. These are the GrADs name from the NOMADS server. Human (administrative) interaction is required to update a model/group configuration. You can edit the AWIPS naming to match the naming with an AWIPS II-recognized parameter definition. New or updated model/group parameter XML files are placed into the `$EDEX_HOME/data/common_static/$SITE/datadelivery/lookups`. The files in `$SITE` take precedence over base-level files like normal AWIPS II EDEX localization.

The other type of lookup configuration is the Level lookup. These lookup XML files normally do not require any human (administrative) interaction. They are auto-generated upon first discovery and placed into the `$EDEX_HOME/data/common_static/$SITE/datadelivery/lookups`. These files are created directly from queries to the NOMADS GrADs server so no editing should be necessary. Here is an example of a level lookup XML file (GFS levels).

```
<?xml version="1.0" encoding="UTF-8" standalone="yes"?>
<LevelLookup>
  <Level>1000.0</Level>
  <Level>975.0</Level>
  <Level>950.0</Level>
  <Level>925.0</Level>
  <Level>900.0</Level>
```

```

    <Level>850.0</Level>
    <Level>800.0</Level>
    <Level>750.0</Level>
    <Level>700.0</Level>
    <Level>650.0</Level>
    <Level>600.0</Level>
    <Level>550.0</Level>
    <Level>500.0</Level>
    <Level>450.0</Level>
    <Level>400.0</Level>
    <Level>350.0</Level>
    <Level>300.0</Level>
    <Level>250.0</Level>
    <Level>200.0</Level>
    <Level>150.0</Level>
    <Level>100.0</Level>
    <Level>70.0</Level>
    <Level>50.0</Level>
    <Level>30.0</Level>
    <Level>20.0</Level>
    <Level>10.0</Level>
  </LevelLookup>

```

### 29.2.5 Unit Configurations

The Data Delivery EDEX has built-in accommodation for incorrect SI (International System of Units) unit designations that are sometimes accompanied by provider data set parameters. A list of discovered NOMADS unit inconsistencies and their corrections are contained within the UnitConfig.xml file. This file exists in the **\$EDEX\_HOME/data/utility/common\_static/\$SITE/datadelivery/lookups directory**. If you discover a parameter that may not be displaying correctly in CAVE, and the data is current and was successfully retrieved, it may very well have an incorrect unit designation that the AWIPS II unit converter does not recognize. The AWIPS II unit converter should recognize all SI standard units. NOMADS testers have created unit configuration overrides for non-SI units that they identified, and they are included in the standard file that you get with the install (displayed below). You are free to add to this list of overrides the correct SI unit designations that you discover on NOMADS and other future providers.

```

<?xml version="1.0" encoding="UTF-8" standalone="yes"?>
<!-- Correct any inconsistencies in the units -->
<unitLookup>
  <unitConfig name="K" providerName="k"/>
  <unitConfig name="Pa" providerName="pa"/>
  <unitConfig name="Pa" providerName="pascals"/>
  <unitConfig name="Pa/s" providerName="pa/s"/>
  <unitConfig name="J/kg" providerName="j/kg"/>
  <unitConfig name="W/m^2" providerName="w/m^2"/>

```

```

<unitConfig name="m/s" providerName="meter/sec"/>
<unitConfig name="N/m^2" providerName="newton/m2"/>
<unitConfig name="N/m^2" providerName="n/m^2"/>
<unitConfig name="C" providerName="degc"/>
<unitConfig name="C-m/s" providerName="degc-m/s"/>
<unitConfig name="kts/200ft" providerName="knots/200feet"/>
<unitConfig name="km^2kg-s^-1" providerName="km2kg-1s-1"/>
<unitConfig name="K/s" providerName="k/s"/>
<unitConfig name="m^2/s" providerName="m2/s"/>
</unitLookup>

```

All registry communications is now performed over HTTPS backed by certificate verification. Along with the certificates there is also a validation of federation nodes to user accounts and there passwords. This is useful for the Registry Web GUI Interface and is controlled from there as such, thus, securing it as well. The setup is pretty straightforward. The administrative user account for each node is named after the ClusterID identifier from setup.env. So, Site OAX has user name of OAX for the GUI. The two that might not be as intuitive are the MADIS DPA and the Central Registry. These will be identified as “DPA” for the DPA and “NCF” for the Central Registry.

### 29.2.6 Data Set Information Lookup

Within the Data Delivery EDEX at the Central Registry, there exists a file called the DataSetInformationLookup.xml. This file is semi-default driven but it can be manually edited. The purpose of this file is to better estimate the offset times and expected arrival times of Gridded Data Set Metadata from NOMADS. This file is located in the same directory as the Parameter and Level Look ups. Here is a sample snippet from this file.

```

.<?xml version="1.0" encoding="UTF-8" standalone="yes"?>

<!--

This file is intended for use by the NCF to tweak Data Set availability offsets

for given dataset groups, be careful what you do here, these are semi-default in
nature.

-->

<DataSetInformationLookup>

    <dataSetInformation>

        <modelName>wave_mww3</modelName>

        <multiplier>1.5</multiplier>

```

```

        <modelRunIncrement>3</modelRunIncrement>

        <defaultOffset>270</defaultOffset>

    </dataSetInformation>

    <dataSetInformation>

        <modelName>rap32</modelName>

        <multiplier>1.5</multiplier>

        <modelRunIncrement>1</modelRunIncrement>

        <defaultOffset>70</defaultOffset>

    </dataSetInformation>

    <dataSetInformation>

        <modelName>rtofs_native_048_gma</modelName>

        <multiplier>1.5</multiplier>

        <modelRunIncrement>6</modelRunIncrement>

        <defaultOffset>270</defaultOffset>

    </dataSetInformation>

```

The purpose of the `<modelName>` field is self-explanatory. The `<multiplier>` field is used as the factor to which the `<defaultOffset>` is multiplied by when making the full expected metaData arrival window. In short, the `defaultOffset * multiplier = arrival window in minutes`. The `<modelRunIncrement>` gives you the number of hours between expected model runs. The values for the `<defaultOffset>` are somewhat dynamic. The actual offset used in the calculations for bandwidth usage are averaged over the arrival times for the last 10 model metaData files. The system “learns” over time. This gives a sharper estimate of bandwidth usage at a given time. Therefore, the Bandwidth Manager can more accurately reflect reality in its forecast usage. So be sure to understand the implications of raising or lowering the offset. It is considered a good rule of thumb that the `<defaultOffset>` is generally = the `<multiplier> * <modelIncrement>` in minutes.

It is important to note that a user account for a given federation node must exist at the Central Registry before that registry will be allowed into the federation (replication, dataset transfers, etc). There is a very important “Chicken and Egg” paradox at work here. You have to have the user created in the central before you can turn on your node and join the federation. On the

Central Registry, an account with the user name “NCF” will be automatically created as startup. Go to the designated URL of the your CentralRegistry, i.e. “[https://{\\$FQDN}:8082](https://{$FQDN}:8082)”. You will be prompted for the username and password in the dialog that comes up. The default password is “password” PLEASE change this immediately.

First Page when you log in will be the Query Manager Dialog as shown in Exhibit 29.2.6-1.

<p><a href="#">Query Interface</a></p> <p><a href="#">Define Query</a></p> <p><a href="#">Subscription Backup</a></p> <p><a href="#">Federation Status</a></p> <p><a href="#">User Admin</a></p>	<p><b>Query Manager Interface</b></p> <p>Return Request <input type="text" value="False"/></p> <p>Response Option <input type="text" value="Object Ref"/></p> <p>Depth <input type="text"/></p> <p>Federated <input type="text" value="False"/></p> <p>Federation <input type="text"/></p> <p>Format <input type="text"/></p> <p>Language <input type="text"/></p> <p>Match Older Versions <input type="text" value="False"/></p> <p>Max Results <input type="text"/></p> <p>Start Index <input type="text"/></p> <p>Query Type <input type="text" value="AdhocQuery"/></p> <p>queryLanguage <input type="text"/></p> <p>queryExpression <input type="text"/></p>
--------------------------------------------------------------------------------------------------------------------------------------------------------------------------------------------------	-------------------------------------------------------------------------------------------------------------------------------------------------------------------------------------------------------------------------------------------------------------------------------------------------------------------------------------------------------------------------------------------------------------------------------------------------------------------------------------------------------------------------------------------------------------------------------------------------------------------------------------------------------------------

**Exhibit 29.2.6-1: Query Manager Dialog**

Select the User Admin dialog to Add, Update, Delete users. This is shown in Exhibit 29.2.6-2

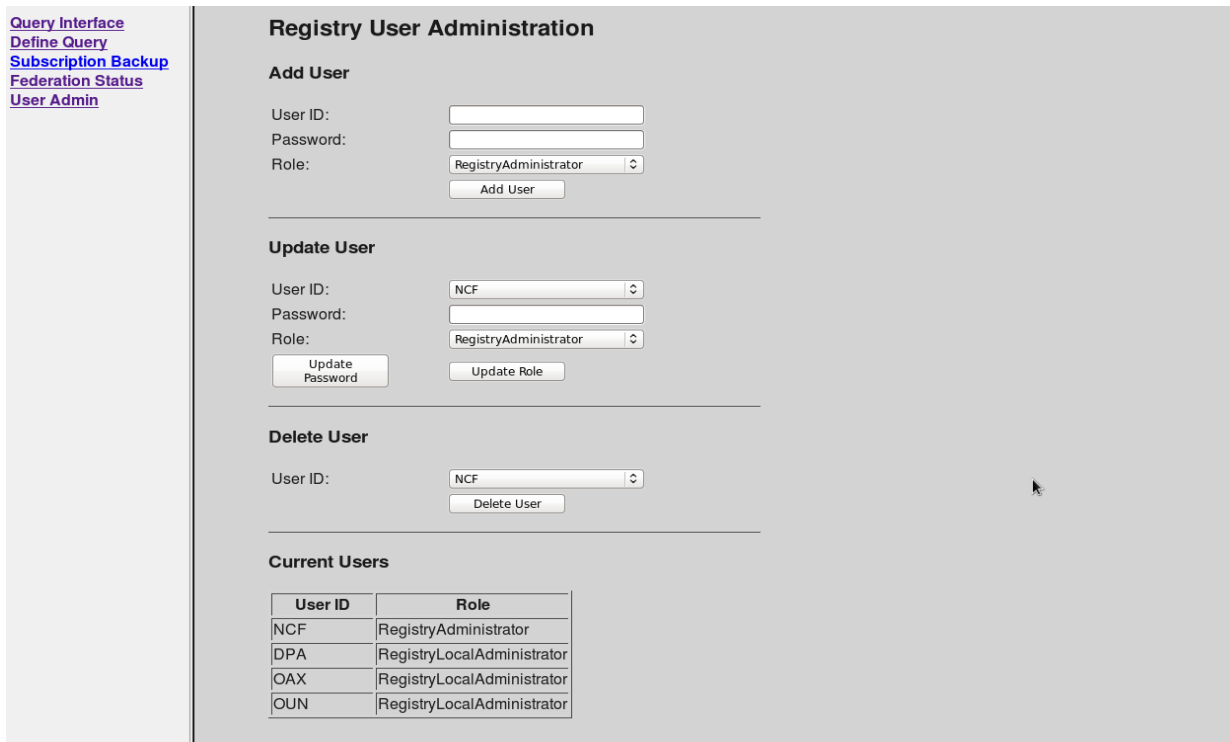

**Exhibit 29.2.6-2: User Admin Dialog**

In initial setup for adding a new node, The “Role” is “RegistryLocalAdministrator”. And the “User ID” is the Cluster ID. An example is shown below in Exhibit 29.2.6-3.

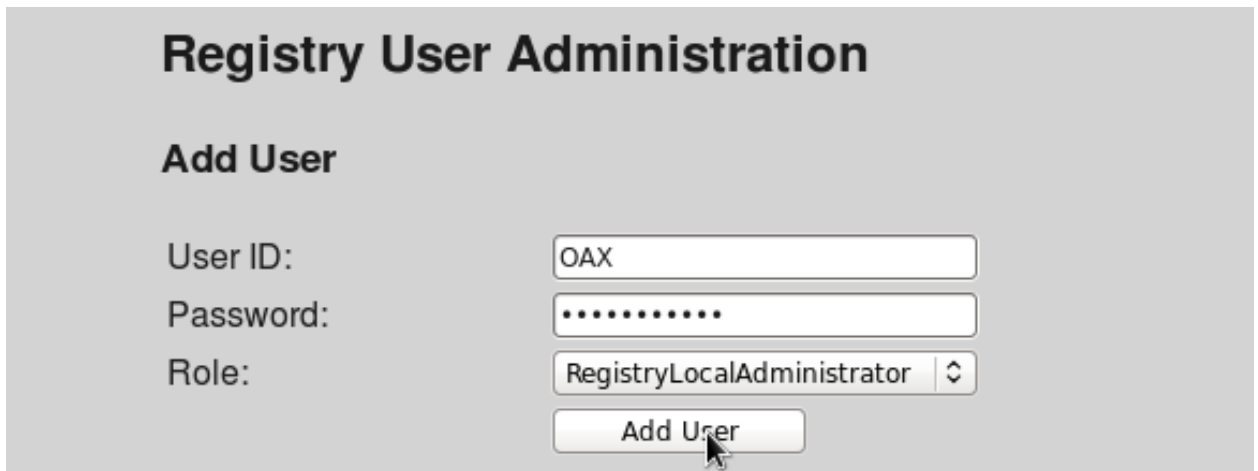

**Exhibit: 29.2.6-3: Registry User Administration**

Once your user is added, you will see it at the bottom in the User list at the bottom of the page as shown in Exhibit 29.2.6-4.

You can then turn on your registry (In this case OAX) and begin synchronization.

Current Users	
User ID	Role
NCF	RegistryAdministrator
DPA	RegistryLocalAdministrator
OAX	RegistryLocalAdministrator
OUN	RegistryLocalAdministrator

**Exhibit: 29.2.6-4: Current Users List**

### 29.2.7 Registry User “Roles” definition

Under the User Admin Menu, the user will notice the different roles available to a registry user entity. The top user “role” is that of “RegistryAdministrator”. That definition is used as the user for the Central Registry. There should really be only one RegistryAdministrator in any given federation. In the case of a Data Delivery federation it is designated as “NCF”. The next identified role is that of the “RegistryLocalAdministrator”. There can be many of these in a federation. These identify the user a node registry uses to replicate with the Central Registry. Examples of these are “OAX” for the OAX WFO, and any data providers that authenticate and insert data sets to the registry directly, such as the MADIS DPA, designated “DPA”. Beneath these users are the “RegistryUser” and “RegistryGuest”. These users, for the most part, are only allowed “read” privileges for the registry Query Interface. Allowing then to query registry objects/metadata but not insert or update. These should be of limited use to a System Administrator who would be looking to maintain his/her registry.

### 29.3 Monitoring (Notification) and Statistics

Within Data Delivery EDEX, there are two types of data that are being harvested for statistics. These are in addition to the standard ingest plugin statistics that are gathered by EDEX in general. These statistics are intended to be used to help tune the Data Delivery EDEX system. They can be helpful in Bandwidth Management and Subscription Scheduling, and as a general guide to tracking the system for Data Delivery.



### 29.3.1 Registry Statistics

The registry statistics default configuration file is deployed to the **\$EDEX\_HOME/data/utility/edex\_static/base/stats** directory. The file name is **registryProcessStats.xml**. The editable fields in this file are in the `<statisticsGroup>` tags. With the current file, all of the current groupings are listed, which means that statistics gathered for Data Delivery registry transactions will be grouped by Owner, Status, and Type of Transaction. Statistics for the registry are available for view in the CAVE menu. An example registry statistics file follows.

```
<statisticsConfig>
<!-- Event Type should be fully qualified name of stat event -->
  <statisticsEventtype="com.raytheon.uf.common.registry.event.RegistryStatisticsEvent"
    displayName="Registry Statistics" category="Registry">
    <statisticsGroup name="owner" displayName="Transaction Owner" />
    <statisticsGroup name="status" displayName="Transaction Status" />
    <statisticsGroup name="type" displayName="Transaction Type" />
    <statisticsAggregate field="duration"
      displayName="Total Registry Duration" displayUnit="Minutes" />
  </statisticsEvent>
</statisticsConfig>
```

**Important Note:** The only things that are editable in the XML file are `displayUnit` and `DisplayName`. `<statisticsGroups>` can also be removed. However, be advised that you are removing fields that are currently being used to gather statistics and thus you will lose some data compared to the default settings. An EDEX restart is required for changes to appear in registry statistics.

### 29.3.2 Subscription/Data Retrieval Statistics

In Data Delivery the most important performance metrics for tuning Bandwidth Management are the Data Retrieval and overall Subscription Retrieval statistics.

From these two Statistics groupings, you can determine four things:

1. Number of successful subscriptions vs. failed subscriptions.
2. Number of successful retrievals vs. failed retrievals.
3. Successful subscriptions that had data retrieval failures.
4. Failed subscriptions with some successful retrievals.

In this way, you can pinpoint the problems with the Bandwidth Management and adjust available bandwidth or latency accordingly. The retrieval/subscription statistics default configuration file is deployed to the **\$EDEX\_HOME/data/utility/edex\_static/base/stats** directory. The file name is **retrievalProcessStats.xml**. An EDEX restart is required for changes to appear in retrieval/subscription statistics.

```

<statisticsConfig>
  <!-- Event Type should be fully qualified name of stat event -->
    <statisticsEvent
      type="com.raytheon.uf.common.datadelivery.event.retrieval.SubscriptionRetrievalEvent"
        displayName="Subscription Retrieval" category="Data Delivery">
      <statisticsGroup name="plugin" displayName="Data Type" />
      <statisticsGroup name="provider" displayName="Data Provider" />
      <statisticsGroup name="owner" displayName="Owner" />
      <statisticsGroup name="network" displayName="Network Route" />
      <statisticsGroup name="subscriptionType" displayName="Subscription Type"
      />
      <statisticsAggregate field="numFailed"
        displayName="Number of Failed Subscriptions" />
      <statisticsAggregate field="numComplete"
        displayName="Number of Completed Subscriptions" />
    </statisticsEvent>

    <statisticsEvent
      type="com.raytheon.uf.common.datadelivery.event.retrieval.DataRetrievalEvent"
        displayName="Data Retrieval" category="Data Delivery">
      <statisticsGroup name="plugin" displayName="Data Type" />
      <statisticsGroup name="provider" displayName="Data Provider" />
      <statisticsGroup name="owner" displayName="Owner" />
      <statisticsGroup name="network" displayName="Network Route" />
      <!--
        Display unit options are KB, MB, GB
      -->
      <statisticsAggregate field="bytes"
        displayName="Amount of Data Downloaded" displayUnit="MB" />
      <statisticsAggregate field="numRecords"
        displayName="Number of Records Downloaded" />
    </statisticsEvent>
  </statisticsConfig>

```

### 29.3.3 System Management

There have been additions made to the System Management Interface in CAVE. The two significant additions are the Provider Username and Password storage and the “Rules” for subscriptions overlap.

#### Rules Configuration

Rules configuration is performed with the GUI in CAVE under the Data Delivery-System Management-Rules menu entry. It creates XML files that can be viewed and or edited manually if necessary. The files are as listed:

- GRIDSubscriptionOverlapRules.xml
- POINTSubscriptionOverlapRules.xml

The above files are located in the  
**\$EDEX\_HOME/data/utility/common\_static/site/\$SITE/datadelivery/systemManagement/  
 rules** directory.

An example follows:

```
<?xml version="1.0" encoding="UTF-8" standalone="yes"?>
<gridSubscriptionOverlapConfig>

<maxAllowedParameterDuplication>100</maxAllowedParameterDuplication>
    <maxAllowedSpatialDuplication>50</maxAllowedSpatialDuplication>
    <matchStrategy>MATCH_ANY</matchStrategy>

<maxAllowedForecastHourDuplication>100</maxAllowedForecastHourDuplication>
    <maxAllowedCycleDuplication>100</maxAllowedCycleDuplication>
</gridSubscriptionOverlapConfig>
```

The rules are based on the concept of 100% being a total match between two subscriptions for any given category checked. In this file you set the threshold at which two subscriptions for a category are considered too much alike. The categories checked cover parameter, temporal, and spatial characteristics of Point and Grid type subscriptions. MADIS data for instance, uses the Point Overlap rules and NOMADS (OpenDap) subscriptions use the Grid rules. It is preferred to use the GUI to make modifications to these subscriptions but if needed they can be directly edited.

The second System Management area of interest is Username and Password storage for Provider's that require secure connections. This is done in two stages. A Provider "Key" is stored in a DB table called "datadeliveryproviderkey". In that table is stored the provider encryption key and the provider name as the primary key. This key is used in the decryption of the Username and Password fields in the stored "Connection" object for this provider. The connection object is stored in

**\$EDEX\_HOME/data/utility/common\_static/site/\$SITE/datadelivery/connection  
 directory.**

Sample MADIS stored Username and Password.

```
<connection>
    <userName>FHS*^%VIKKB__N)</userName>
    <password>*^*RV__NBIO&VHG^&$^&</password>
    <encryption>
        <padding>Type of Padding</padding>
        <algorithm>Type of Algorithm</algorithm>
```

```

    <encryption/>

    <url>http://stormy.oma.us.ray.com:8085/wfs</url>

</connection>

```

The key and the Username and Password are only brought together upon the reading/writing of encrypted values. This allows for a reasonably secure automated storage schema for them. The CAVE GUI in this case under Delivery-System Management-Provider Connection is the **ONLY** way in which you can edit these connection files. Do not attempt to do it manually. It will not work.

New providers that will be added to the Data Delivery System. Some of these providers will require user name and password authentication. For client nodes in the federation (WFO's), a GUI exists under the Data Delivery > System Management > Settings menu item in CAVE. The Central Registry in a federation has no such GUI available. So, a shell script has been provided to accommodate the creation of provider specific user name and password combinations. These credentials are stored as an AES encrypted string in provider specific "Connection" files stored in site level localization. This file is read systematically by Data Delivery when it is necessary for the server to communicate with the given provider. The script is located on the Central Registry in the "/awips2/edex/bin" directory.

Example run...

```
bash-4.1$ ./centralRegistryProviderCredentials.sh
```

```
CLUSTER_ID undefined. Determining from hostname...
```

```
CLUSTER_ID could not be determined from hostname. Using site [OAX] as
CLUSTER_ID
```

```
Enter Data Provider Data:
```

```
Connection Directory:
```

```
/awips2/edex/data/utility/common_static/site/OAX/datadelivery/connection/
```

```
Provider Name: PDA
```

```
Provider Key: deguello
```

```
User Name: dave
```

```
Password: deguello
```

```
Encryption Algorithm [AES] :
```

```
Encryption Padding [AES/CFB8/NoPadding] :
```

```
URL: http://espds.pda.gov
```

Writing to output file:

```
/awips2/edex/data/utility/common_static/site/OAX/datadelivery/connection/PDA-connection.xml
```

## 29.4 FAQ

### ***My Data Delivery does not seem to have any metadata in the Data Set Discovery Browser. What could be wrong?***

A combination of things could be wrong. Begin by checking to see if the crawler is indeed running. Go to the /awips2/edex/logs directory. Open the edex-registry-harvester-XXXXXX.log with a text viewer of your choosing. Look for any indication that the “Main Sequence Scan” crawler is running in the file. If you see lots of errors or “couldn’t start,” go through the following checklist.

1. Is your proxy configured correctly? [If your proxy is not right, you will never be able to connect. If it is not correct, edit the proxy.properties file accordingly.]
2. Do you have the correct Provider root URL? Check the root URL in your NOMADS-harvester.xml. Try it in a web browser; does it work? If it does not work, you may have it incorrect or you have other (deeper) network configuration problems.
3. If your crawler is running and seems to be collecting metadata, you can prove this by looking in the logs for entries like this.

```
INFO 2013-01-23 00:00:04,029 [crawlerThreadPool-
[DefaultQuartzScheduler_Worker-5]] Crawler: EDEX - Starting crawl
[2/78], provider [NOMADS], collection [narre], model [narre], date
[20130123], politeness delay [100]
```

```
INFO 2013-01-23 00:00:04,031 [crawlerThreadPool-
[DefaultQuartzScheduler_Worker-5][pool-50-thread-1]]
FileCommunicationStrategy: EDEX - Wrote linkStore: NOMADS : narre
size: 89
```

This means that your Data Delivery EDEX is at least finding metadata and that the problem is further downstream than the crawler. Now open the edex-registry-harvester-XXXXXX.log. If you see a lot of errors in this log, it is indicative of a problem with your Data Delivery Registry. You should see entries like this in general.

```
INFO 2013-01-08 19:56:49,280 [harvesterThreadPool-2
LifecycleManagerImpl: EDEX - LifecycleManager
receivedsubmitObjectsRequest
```

```
INFO 2013-01-08 19:56:49,280 [harvesterThreadPool-2]
LifecycleManagerImpl: EDEX - 1 object submitted to registry
```

```
INFO 2013-01-08 19:56:49,280 [harvesterThreadPool-2]
LifecycleManagerImpl: EDEX - Validating objects...
```

```
INFO 2013-01-08 19:56:49,280 [harvesterThreadPool-2]
LifecycleManagerImpl: EDEX - Objects successfully validated!
Submitting...
```

```
INFO 2013-01-08 19:56:49,280 [harvesterThreadPool-2]
LifecycleManagerImpl: EDEX - Processing object
```

```
[http://nomads.ncep.noaa.gov:9090/dods/sref/sref20130108/sref_na132_
nmm_p3_15z]
INFO 2013-01-08 19:56:49,343 [harvesterThreadPool-2]
LifecycleManagerImpl: EDEX - Object

[http://nomads.ncep.noaa.gov:9090/dods/sref/sref20130108/sref_na132_
nmm_p3_15z] added to the registry.
INFO 2013-01-08 19:56:49,362 [harvesterThreadPool-2]
LifecycleManagerImpl: EDEX - Submit objects successful
INFO 2013-01-08 19:56:49,362 [harvesterThreadPool-2]
LifecycleManagerImpl: EDEX - Creating auditable events....
INFO 2013-01-08 19:56:49,365 [harvesterThreadPool-2]
LifecycleManagerImpl: EDEX - LifeCycleManager submitObjects
operation completed in 85 ms
```

Anything different would indicate a problem.

4. Check to see if the “MetaDataHandler” is finding the directories where metadata is deposited by the crawler. The `$EDEX_HOME/data/utility/common_static/$SITE/datadelivery/harvester` directory contains two subdirectories. The “links” directory is where the crawler deposits the data set links it has discovered during the crawl. The “MetaDataHandler” reads this directory once a minute to check for new metadata. If the permissions on this directory are bad or the files within have become corrupted, problems can ensue causing no metadata to be read and ingested into the registry. The files in this directory are XML files that contain the URL link for the new metadata. The other file to check is the “times” directory. Generally, if the “MetaDataHandler” is running well, no times files will be contained in the times directory. If you notice any persistent files, that could indicate a problem. The best course of action would be to delete the conflicting files.
5. If the crawler is not running, check to see if a “lock” file exists in the `$EDEX_HOME/data/utility/common_static/$SITE/datadelivery/harvester` directory. You will be looking for a file called `NOMADS-main-crawl.lock` (or `NOMADS-seed-crawl.lock` if you are debugging the Seed Scan process). The Crawler uses this file as a locking semaphore to prevent new crawlers from running if one is already in progress. Check the permissions on this file; they should be `<awips2, fxalpha>` (user, group). If not, delete them and wait for the next crawler to kick off based on your crontab setting in the harvester configuration file.
6. Did you look at your crontab settings in the harvester configuration file? Are they correct? If they are not in what would pass as “standard crontab syntax,” they will not work and your Crawler will never launch. Therefore, you will never get any metadata in the Discovery Browser. The web is a good resource for devising a good strategy for crontabs. Remember that, when doing your crontab, it is prudent to have the window large enough for the crawler to finish completely between scans. Otherwise, your scans will be tripping over each other and you may end up with gaps in your update schedule for data sets.
7. I cannot get my Data Delivery server to sync with the NCF Central Registry. There

are many things that can go wrong with registry federation that may be difficult to figure out. Here are a few tips to help with diagnostics.

- Check the notificationServers.xml to see if you are setup to sync.
- Before you do anything check this file to make sure it has “NCF” in it.
- Also, check setupenv (/awips2/edex/bin) to see if the NCF\_HOST is correct.
- Finally, try “pinging” the NCF\_HOST machine.

# **Chapter 30**

## **User Administration**



## Chapter 30. User Administration

### Table of Contents

	<i>Page</i>
30.1 Overview .....	1
30.2 Initial Configuration .....	2
30.3 Configuration File Format .....	3
30.4 Use of the User Admin Dialog .....	4
30.4.1 User Administration Users Tab .....	6
30.4.2 User Administration Roles Tab .....	8

### List of Exhibits

Exhibit 30.4-1. AWIPS User Administration - User Admin Dialog Box ('A User Administrator').....	4
Exhibit 30.4-2. AWIPS User Administration - Alert Message ('Not a User Administrator').....	5
Exhibit 30.4-3. Permission-Controlled Components .....	6
Exhibit 30.4.1-1. User Admin GUI for User Administration Users .....	7
Exhibit 30.4.1-2. Add New User Dialog Box .....	8
Exhibit 30.4.1-3. Edit User (Assigned Roles and Assigned Permissions) Dialog Box.....	8
Exhibit 30.4.2-1. User Admin GUI for User Administration Roles .....	9
Exhibit 30.4.2-2. Add a New Role.....	10
Exhibit 30.4.2-3. Edit Role .....	10
Exhibit 30.4.2-4. Assigned Roles .....	11
Exhibit 30.4.2-5. Assigned Permissions .....	11
Exhibit 30.4.2-6. Assign Role to Users.....	12

### 30.1 Overview

Some of the functions of certain components of CAVE are limited to users who have been granted a specific ‘permission’ or assigned a specific ‘role.’ A ‘permission’ gives a user access to a specific functionality; a ‘role’ authorizes a user to perform a designated group of functions.

Site User Administrators are responsible for issuing and managing ‘permissions’ and ‘roles,’ and for designating other functionalities as being open to “ALL” users. Their mechanism for managing permissions and roles is the AWIPS User Administration software, which is accessed through the **CAVE->AWIPS User Administration...** menu.

Currently, five components of CAVE are controlled by permissions and roles: 1) the User Administration software itself; 2) the Localization perspective; 3) Data Delivery; 4) Official User Product; and 5) Data Archiving. Only permissions may be granted for User Administration, Official User Product, Localization and Data Archiving; both permissions and roles have been defined for Data Delivery.

[**Note:** Data Delivery will only be seen under the Component dropdown menu for systems that can run Data Delivery. The CAVE sessions that do not contain a Data Delivery option are instances where CAVE was deployed/installed without the Data Delivery rpm or with it ‘turned off.’]

Descriptions of the five components follow.

- **User Administration.** Permissions are used to control which users have access to the User Admin dialog, and only one permission has been defined for this dialog: `awips.user.admin`. Users with this permission have user administrator rights.

No roles have been defined for the User Admin dialog.

By default, no users have permission to access this dialog at the time the system is installed. It is expected that each site will grant specific users the `awips.user.admin` permission. [See section 30.2 for details.]

- **Localization.** Permissions are used to control which users have access to which Localization files. For example, `com.raytheon.localization.site/common_static/gfe` is the permission that controls access to the GFE localization files. Any user who is assigned that permission has access to site-level `gfe common_static` localization files.

The Localization component comes with permissions already set up for the special ALL user (by default). Localization also allows for the creation of new permissions.

No roles have been defined for Localization.

- **Data Delivery.** The Permissions within Data Delivery control what individual users are allowed to do within the Data Delivery software, for example, create/edit/delete subscriptions, edit subscription groups, or manage system access. Two roles have been defined for Data Delivery. One is the `subscription.user` role, which packages the

- subscription.view, subscription.create, subscription.edit, and subscription.delete permissions; this allows the user to view, create, edit, and delete his or her own subscriptions. The second role is subscription.admin, which grants a user all the permissions packaged in the subscription.user role, and adds the group.edit and subscription.approve.all permissions. A user who has been assigned the subscription.admin role can do everything a subscription.user can; he or she can also approve subscriptions and edit existing subscription groups.
- **Official User Product.** The Official User Product permission, awips.oup, determines which users are allowed to send things using the Official User Product framework. By default the permission is added to the “ALL” user so all users at the site can send products, as was done in the past. This permission is in place for users connecting from outside the NOAA firewall. Sites supporting users connecting from outside the firewall will need to lock down their OUP\_Roles.xml file by removing the permission from the ALL user, adding individual users and granting them the awips.oup permission. This will limit the ability of outside users sending Official User Products.
  - **Data Archiving.** The permissions within Archiving are used to control which individual users are allowed to run the Archive Case Creation and Retention software. For example, a selected user who has been granted archive.case creation Roles/Permissions is allowed to run the Archive Case Creation. Similarly, archive.retention Roles/Permissions allow a user to run the Archive Retention software. No roles have been defined for Data Archiving.

## 30.2 Initial Configuration

At the time of initial installation of the AWIPS II software, permissions for the User Administration dialog are locked down, so no one has access. It is up to the sites to determine who should have access to the User Admin software and then perform the User Admin configuration following completion of the initial installation of the AWIPS II software. [Note: Configuration is only completed once, following initial AWIPS II installation; the User Admin dialog does not need to be reconfigured after future installs.]

The steps for initial configuration follow.

1. On the EDEX request server,

```
TYPE:    cd /awips2/edex/data/utility/common_static/base/roles
```

```
TYPE:    cp awipsUserAdminRoles.xml
            /awips2/edex/data/utility/common_static/site/<SITE
            ID>/roles
```

```
TYPE:    cd /awips2/edex/data/utility/common_static/site/<SITE
            ID>/roles
```

2. Using any text editor, edit awipsUserAdminRoles.xml.
  - a. Locate the line that begins with “<user userId=” and replace AuthorizedUserName with a valid user name.

- b. Delete the two lines with the text DELETE THIS LINE.
3. Save the file.
4. Have the user try to access the AWIPS User Administration Dialog from within CAVE.

**Note:** Although the User Administration Configuration file has the userPermission and rolePermission defined, the Administrator is strictly required not to edit those fields and to use the options under the CAVE D2D to set up the userPermission and rolePermission.

### 30.3 Configuration File Format

The User Administration configuration file format is xml. Each file will have an application tag stating which application within AWIPS II uses these permissions.

A **'permission'** is defined by a permission tag with an id attribute where the id is the permission string. Each permission tag can have an optional description tag to describe the permission. A **'role'** is defined by a role tag with a roleId attribute where the roleId is the role string. Each role tag has a roleDescription for describing the role and one or more rolePermission tags to list the permissions belonging to the role.

User tags define the permissions and/or roles assigned to each user. The user tag has a userId attribute listing the user's id. The userPermission tag houses the permissionId or roleId the user has been granted.

A sample file follows.

```
<nwsRoleData xmlns:ns2="group">
  <application>Data Delivery</application>
  <permission id="subscription.view">
    <description>
      Control Access to View Data Delivery Subscriptions
    </description>
  </permission>
  <permission id="subscription.dataset.browse">
    <description>Control access to the Dataset Discovery Browser</description>
  </permission>
  <role roleId="subscription.admin">
    <roleDescription>
      This role is a grouping of permissions, default subscription admin role
    </roleDescription>
    <rolePermission>subscription.approve.all</rolePermission>
  </role>
</nwsRoleData>
```

```

    <rolePermission>subscription.user</rolePermission>
    <rolePermission>group.edit</rolePermission>
  </role>

  <user userId="userName">
    <userPermission>subscription.view</userPermission>
    <userPermission>subscription.dataset.browse</userPermission>
    <userPermission>subscription.admin</userPermission>
  </user>
</nwsRoleData>

```

### 30.4 Use of the User Admin Dialog

Users who are assigned the awips.user.admin permission described in Section 30.2 access the User Admin dialog via the **Cave->AWIPS User Administration...** menu item. To begin, they select the AWIPS User Administration option from the CAVE menu.

When an **authorized** User Administrator selects this option, the screen shown in Exhibit 30.4-1 will appear.

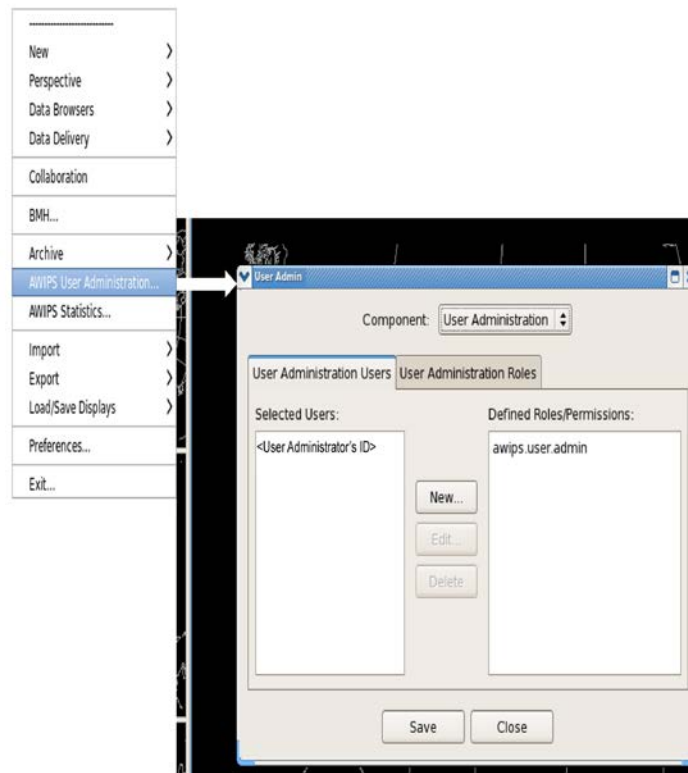

**Exhibit 30.4-1. AWIPS User Administration - User Admin Dialog Box ('A User Administrator')**

An **unauthorized** user will be blocked from entering the **User Admin** dialog, and the Alert Message shown in Exhibit 30.4-2 will appear instead.

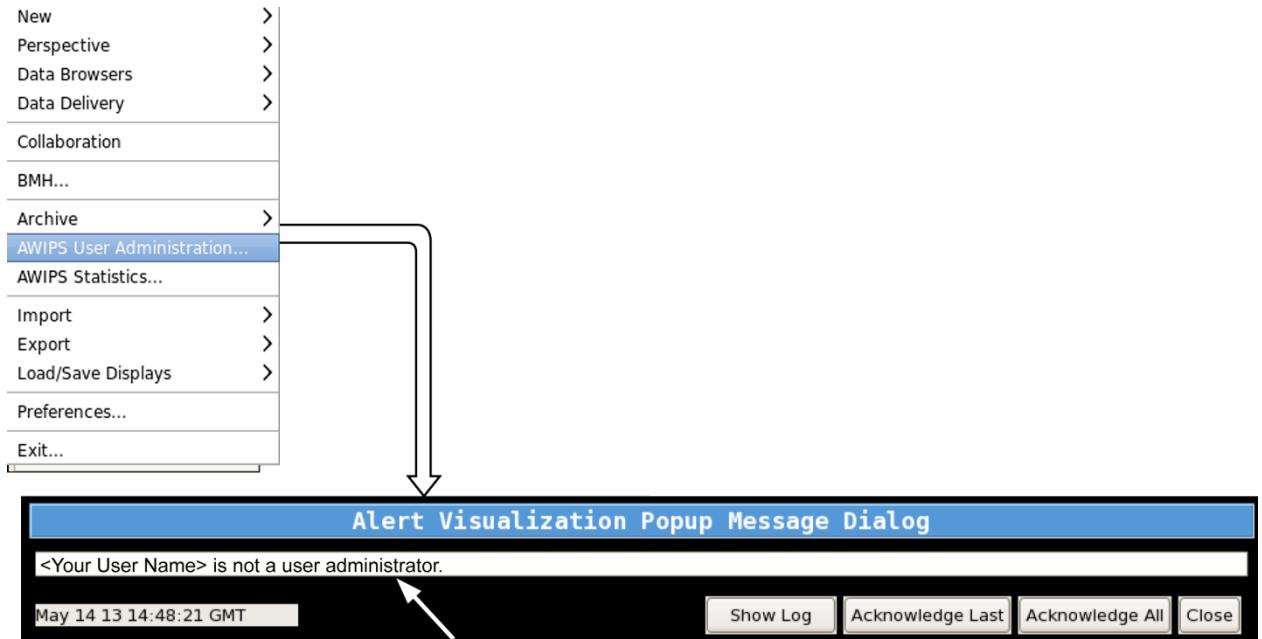

This Alert Message pops up when you select the AWIPS User Administration option and you have not been granted the User Administrator role by the System Manager.

**Exhibit 30.4-2. AWIPS User Administration - Alert Message ('Not a User Administrator')**

At the top of the **User Admin** dialog box is a Component dropdown box (editable) that lists the five components (User Administration, Data Archiving, Data Delivery, Localization, and Official User Product). See Exhibit 30.4-3.

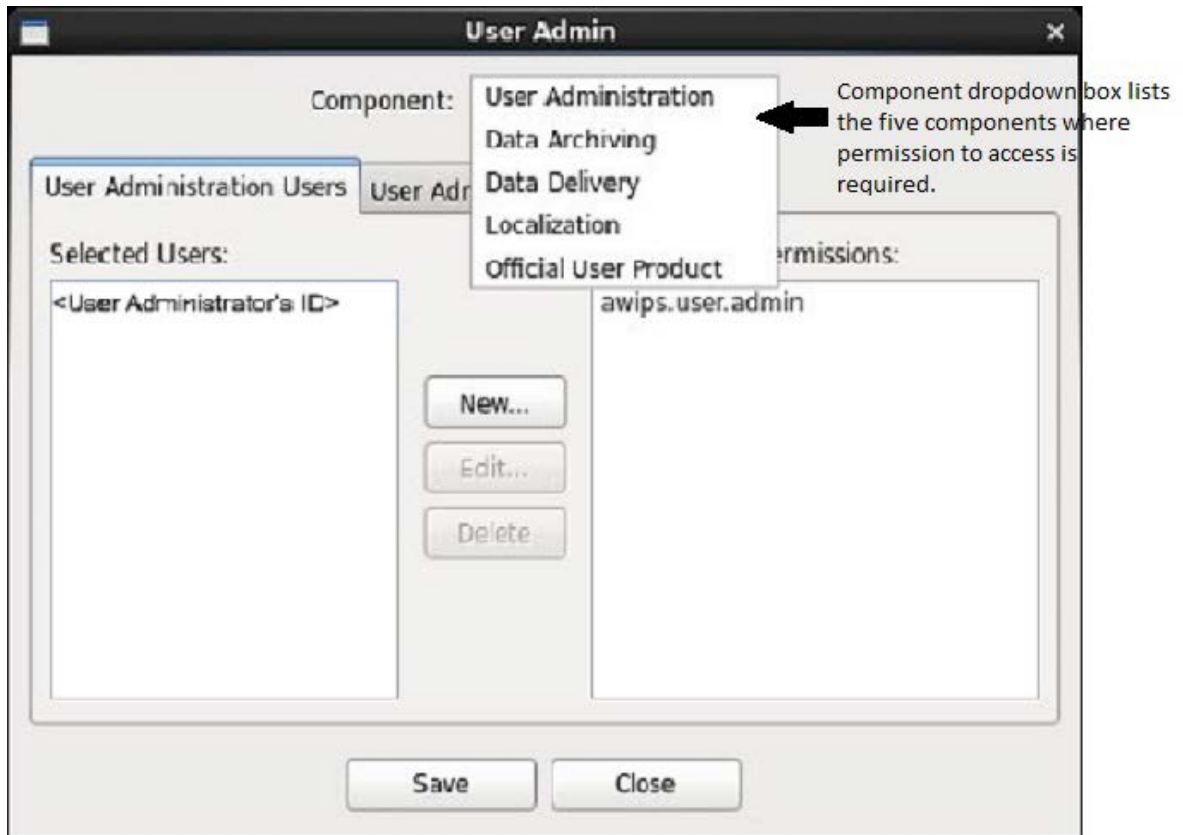
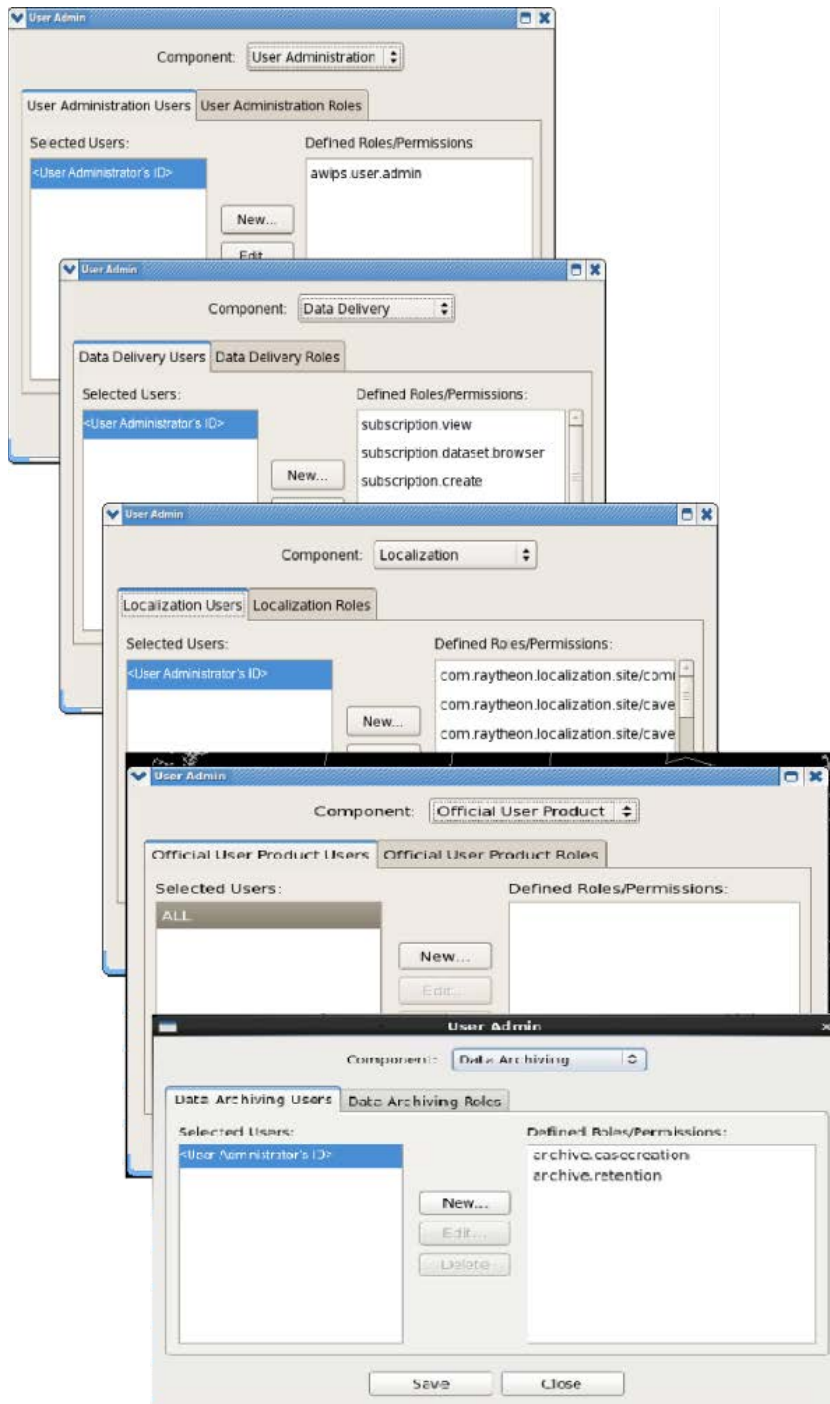

**Exhibit 30.4-3. Permission-Controlled Components**

For each component there are two tabs, the User Administration **Users** tab and the User Administration **Roles** tab.

### **30.4.1 User Administration Users Tab**

The Users tab includes a “Selected Users” window and a “Defined Roles/Permissions” window. They are shown in Exhibit 30.4.1-1 for all five components.



**Exhibit 30.4.1-1. User Admin GUI for User Administration Users**

**Note:** The center buttons on the User Admin dialog box, as well as the Localization and Data Delivery buttons (New, Edit, and Delete) perform different functions, depending on which tab is selected.

The Users tab lists all defined users and the roles/permissions assigned to each user.

- You can add new users to each component by clicking the **New...** button.



Clicking the “New” button opens the **Add New User** dialog box shown in Exhibit 30.4.1-2, which is used to add new users.

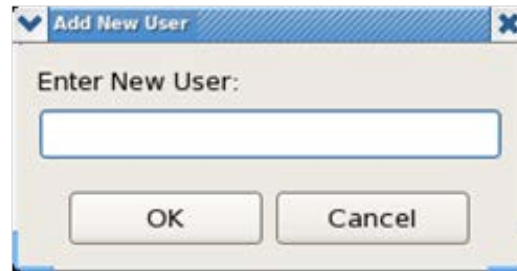

**Exhibit 30.4.1-2. Add New User Dialog Box**

Entering a new user in the **Add New User** dialog box (Exhibit 30.4.1-2) and clicking **OK** opens the **Edit User** dialog box (Assigned Roles and Assigned Permissions) (see Exhibit 30.4.1-3). This dialog box signifies whether roles or permissions are being granted.

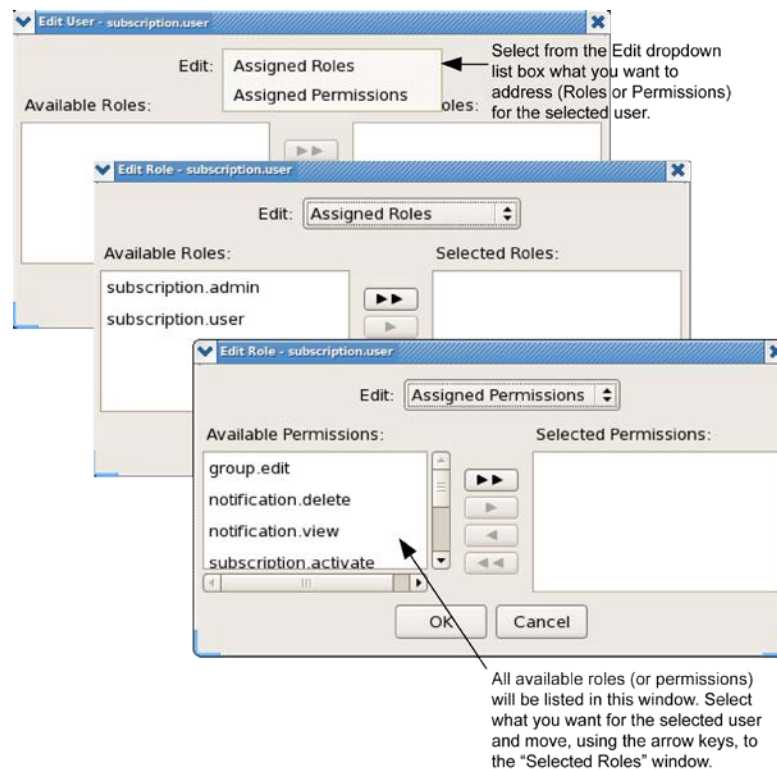

**Exhibit 30.4.1-3. Edit User (Assigned Roles and Assigned Permissions) Dialog Box.**

### 30.4.2 User Administration Roles Tab

The Roles tab includes a “Defined Roles” window and a “Roles/Permissions” window. Exhibit 30.4.2-1 illustrates the windows for all five components.

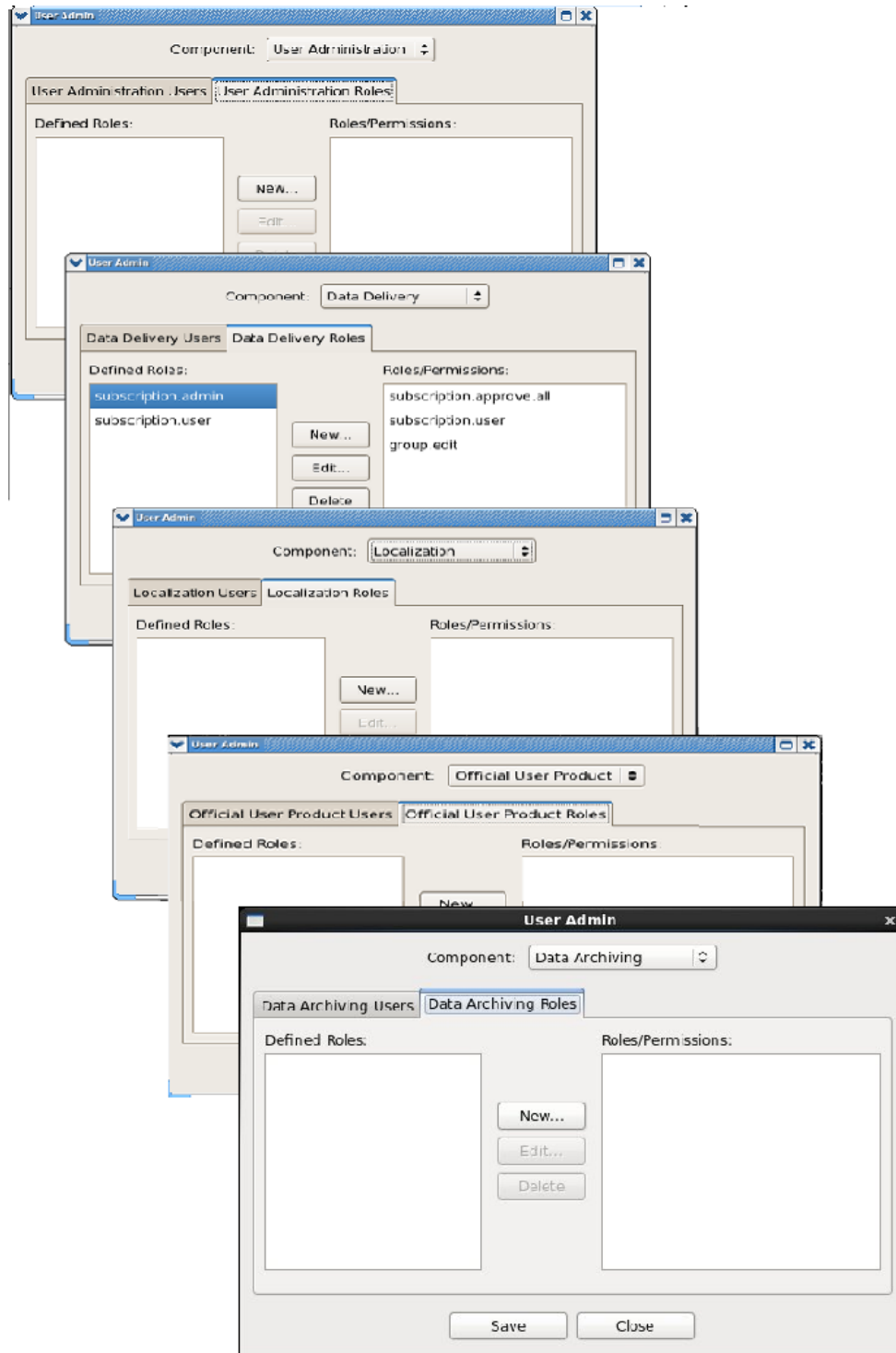

**Exhibit 30.4.2-1. User Admin GUI for User Administration Roles**

**Note:** The center buttons on the User Admin dialog box (New, Edit, and Delete) perform different functions, depending on which tab is selected.

- You can add new role dialogs to each component by clicking the **New...** button.

Clicking the **New...** button displays the Add New Role dialog as shown in Exhibit 30.4.2-2.

**Exhibit 30.4.2-2. Add a New Role**

Once you enter a role name and an optional description and click **OK** to continue, the **Edit Role** dialog is displayed (see Exhibit 30.4.2-3).

**Exhibit 30.4.2-3. Edit Role**

As shown in Exhibit 30.4.2-3, the **Edit Role** dialog (combo box) allows other roles to be assigned to this new role, allows permissions to be assigned to this new role, and allows

the user to assign this role to specific users. These actions are illustrated individually in Exhibits 30.4.2-4, 30.4.2-5, and 30.4.2-6.

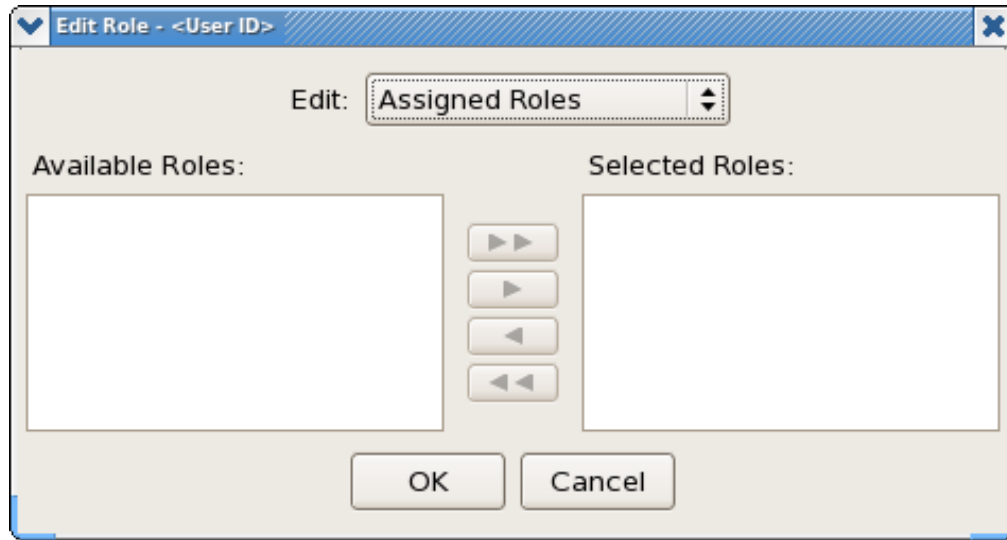

**Exhibit 30.4.2-4. Assigned Roles**

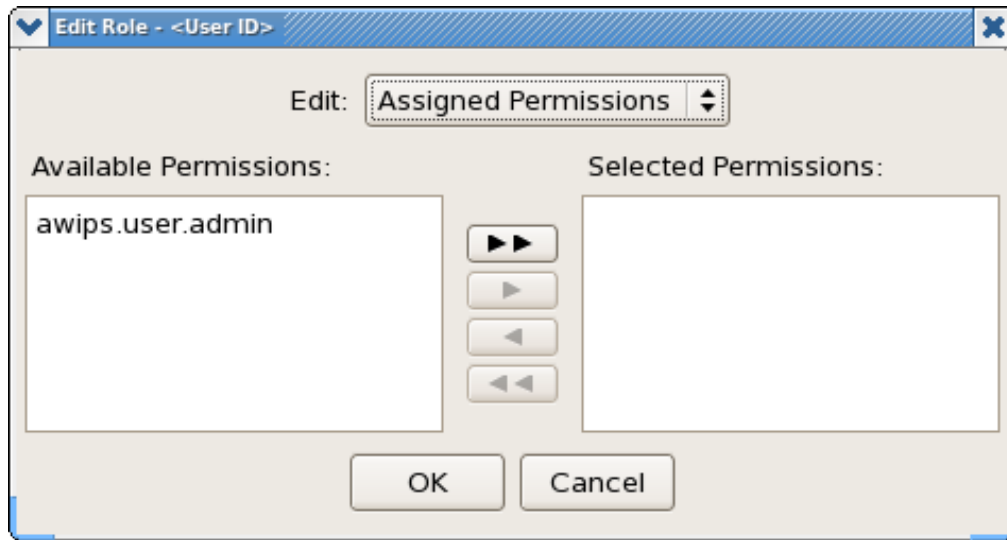

**Exhibit 30.4.2-5. Assigned Permissions**

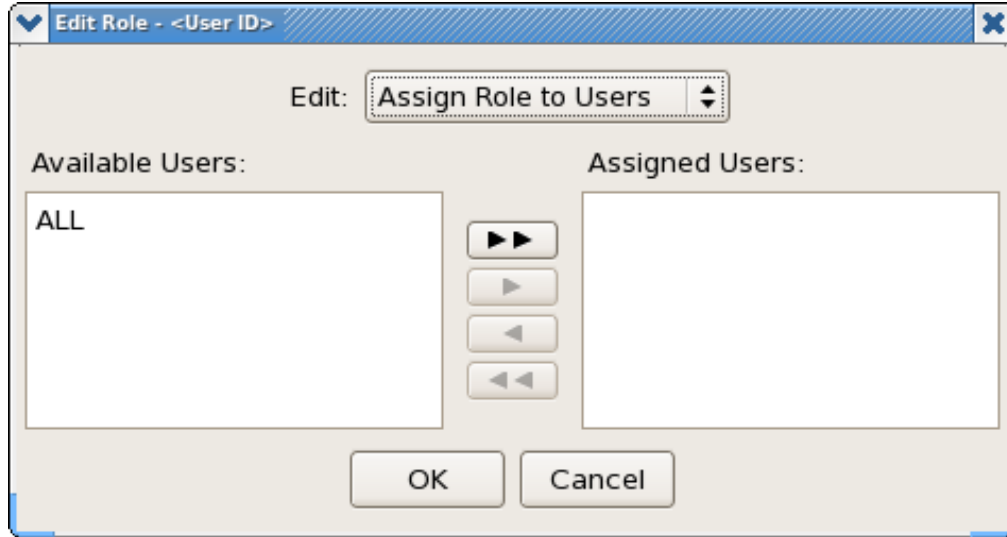

**Exhibit 30.4.2-6. Assign Role to Users**

All changes are stored in memory until the user clicks the **Save** button (see Exhibit 30.4-1). No changes are persisted until the **Save** button is clicked. To cancel changes, click the **Close** button.

# **Chapter 31**

## **Product Generation**

## Chapter 31. Product Generation

### Table of Contents

	<i>Page</i>
31.1 Overview .....	1
31.2 Configuration.....	1

### 31.1 Overview

PGEN (Product Generation) is a component of CAVE, currently available in the D2D and National Centers (NCP) perspectives. It offers multiple functions and capabilities to draw and edit geo-referenced meteorological and non-meteorological objects, and to generate post-processed products from those objects for dissemination. PGEN has been an integral part of National Center (NC) operations since the mid-1990s with the majority of NC products (text bulletins, web graphics, BUFR, and grids) being involved with PGEN at some point in their production. The PGEN capabilities in AWIPS II as a whole are replacing those capabilities found in the legacy NAWIPS NMAP2 application used at the NCs and some offices. This chapter describes the functional capabilities within the AWIPS II implementation from the site manager's perspective.

### 31.2 Configuration

From the site manager's perspective, configuration is limited to that of PGEN Activities. "Activity" is the word used to describe all aspects of a forecaster workflow when using PGEN for a specific purpose. For instance, a forecaster performing the Surface Analysis Activity implies that he or she has a particular PGEN configuration in the following areas:

- Activity type, sub-type and alias
  - These are entirely up to the site manager's discretion
- Default palette configuration
  - Allows you to define what Controls, Actions, object Classes and Objects appear to the forecaster
- Settings table specification
  - Assigns the default rendering information per object
- Layer names and behavior
  - Layers provide useful organizational structure and at least one layer is required.
- Save information
  - Specifies all information need to save back to the PGEN data plugin database
- Filter specifications, optional
  - A filter framework is also embedded inside PGEN and is used in many ways that are not exposed to the user. For instance, object selection is performed using a filter based on the currently selected object Class. The filter framework is designed to be used extensively in future implementations to enhance forecaster efficiency.
- Sharing specifications, optional



- TBD, allows for automatic and on-demand sharing of active PGEN Activity information between Centers
- Clipping specifications, optional
  - Allows for clipping to be performed by a prescribed shape.
- Product specifications, optional
  - Allows for the definition of derived products based on the PGEN XML.

## **Chapter 32**

# **Broadcast Message Handler**

## Chapter 32. Broadcast Message Handler

### Table of Contents

	<i>Page</i>
32.1 Overview .....	1
32.2 BMH Filesystem .....	2
32.3 BMH Configuration .....	5
32.3.1 Configuration Overview .....	5
32.3.2 Configure EDEX BMH .....	9
32.3.2.1 BMH Notification Configuration .....	10
32.4 BMH Process Management .....	14
32.4.1 BMH Process Overview .....	14
32.4.2 Start the BMH System .....	15
32.4.3 Stop the BMH System .....	16
32.4.4 BMH Practice Mode .....	16
32.5 Configuring the DAC .....	17
32.6 Failing over to the spare DAC .....	20
32.6.1 Determining whether a DAC is malfunctioning .....	20
32.6.2 Remedial actions .....	21
32.6.3 Failover procedure .....	21
32.6.4 Installing the replacement DAC .....	28

### 32.1 Overview

This chapter provides an overview of the BMH environment and to provide the procedures required to start/stop and manage the BMH processes. Section 32.5 of this chapter will cover configuration of the DAC hardware.

Exhibit 32.1-1, below provides a high-level overview of the main BMH components and how they interact with each other.

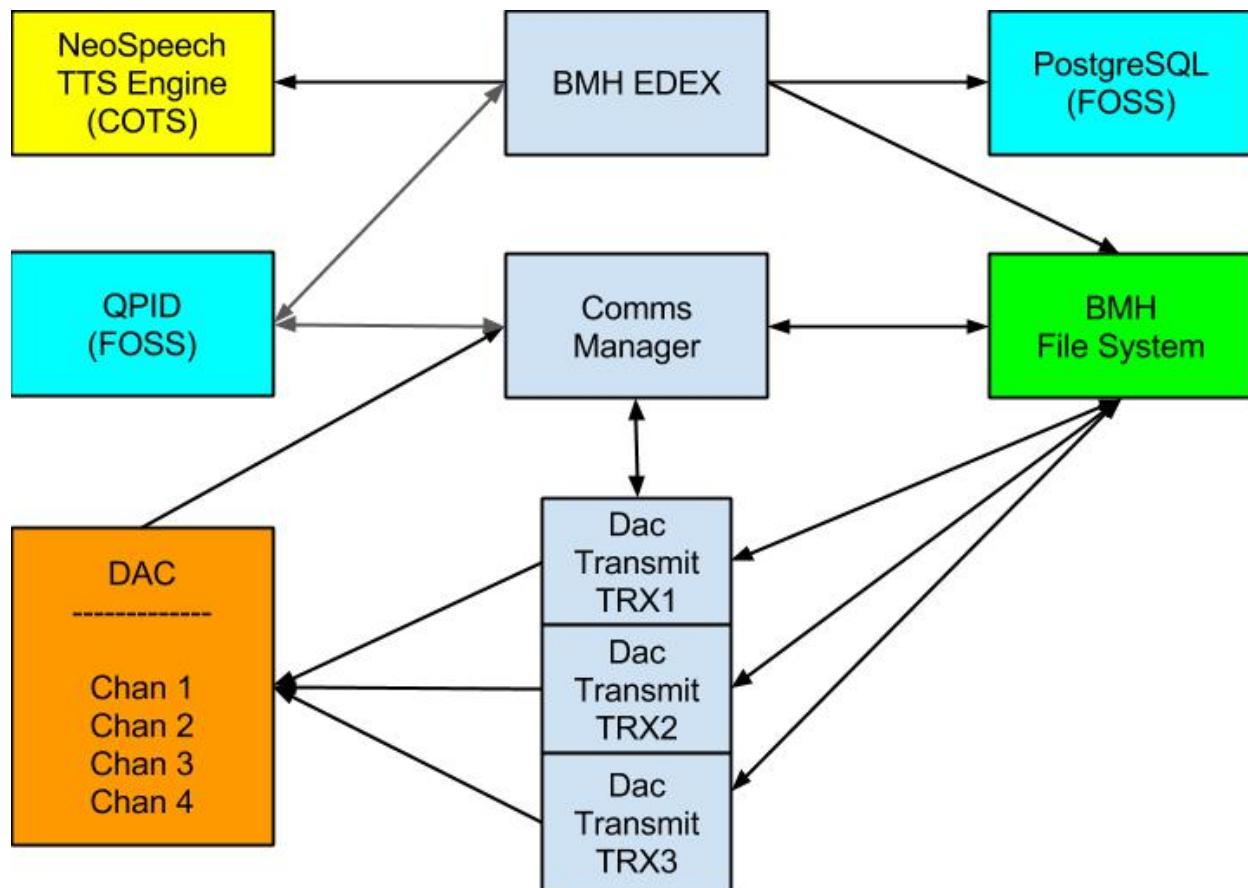

**Exhibit 32.1-1 Overview of BMH Components**

The five main processes in the diagram above include the: TTS Server, BMH EDEX, PostgreSQL, Comms Manager, and the DAC Transmit TRX#. DAC is a hardware component and is responsible for actually broadcasting the audio over the air.

The TTS Server is COTS software and it is used to synthesize text to audio. Synthesized audio is returned as an array of bytes to BMH EDEX and it is written to a file on the BMH File System. BMH EDEX also writes playlist files and the DAC configuration file

to the BMH File System. BMH EDEX will send a notification to Comms Manager to notify it of any configuration and playlist changes. BMH EDEX will also store information in and retrieve information from the `bmh PostgreSQL` database. PostgreSQL is used to store information about DACs, transmitters and messages.

Comms Manager constantly watches the BMH File System for changes to the DAC configuration file. After a change is made, Comms Manager will re-read the configuration and either stop or start DAC Transmit processes (the DAC Transmit TRX# processes in the diagram) to match the configuration. Comms Manager also forwards notifications from BMH EDEX to a particular DAC Transmit process and from any DAC Transmit process back to BMH EDEX. Comms Manager is also capable of connecting to a DAC channel to listen to and forward the audio that is currently being broadcast to another destination.

The DAC Transmit processes are responsible for actually broadcasting the audio to a specific DAC on one or multiple channels. The DAC Transmit processes read both the playlists and the associated audio from the BMH File System.

## 32.2 *BMH Filesystem*

This section provides an overview of the BMH filesystem. In addition to the BMH plugins that are installed into the EDEX filesystem, BMH also has its own filesystem rooted at: `/awips2/bmh`.

The root BMH directory includes the following sub-directories:

- `bin`
- `conf`
- `data`
- `logs`
- `neospeech`

The `bin` directory contains scripts that will be used to start and stop BMH-specific processes (the BMH-specific processes will be identified and explained in section 32.4). The `conf` directory contains logging and process configuration information for the BMH-specific processes. The `neospeech` directory contains the neospeech installation as well as a `result` directory that neospeech will write temporary files to containing synthesized audio.

The `data` directory contains a series of subdirectories that are used to process data and store generated audio and playlists. The purpose of each subdirectory has been described in the **Table 32.2-1** below.

**Table: 32.2-1: Subdirectories**

Subdirectory	Purpose
audio	Used to store audio files synthesized by NeoSpeech that will be or have been scheduled for broadcast. The audio is stored in ulaw format.
nwr/ready	The destination for files that will need to be processed by the BMH system. This directory is similar to the EDEX manual directory.
nwr/archive	This is the archive directory that has all files that have been processed by BMH for the last 30 days
nwr/reject	This is the reject directory that has all files that failed to be processed by BMH in the last 30 days.
playlist	Used to store playlists generated by the BMH system. The playlists indicate which messages should be scheduled for broadcast on a particular transmitter.
practice	Contains the audio files and playlists generated and used by BMH components running in PRACTICE mode. This subdirectory exists to segregate the practice BMH data from the operational BMH data.

The logs directory contains all of the log files that are generated by the BMH processes.

**Note:** the edex-bmh logs written by the BMH EDEX instances will still be written to /awips2/edex/logs. The following **Table 32.2-2** summarizes the log files that are written to the BMH logs directory. For more information about the processes which write to these log files, refer to **Section 32.4.1**.

**Table 32.2-2: Log Files**

Log File	Description
commsmanager-YYYYMMDD.log	The log file that a comms manager process writes to.
commsmanager-message-activity-YYYYMMDD.log	The log file that a comms manager writes message activity notifications (ex: message created, message broadcast, etc.) to.
commsmanager-message-error-YYYYMMDD.log	Log file that a comms manager process writes message error notifications (ex: synthesis failed, etc.) to.

commsmanager-practice-YYYYMMDD.log	The log file that a comms manager process writes to when it is running in practice mode.
commsmanager-practice-message-activity-YYYYMMDD.log	The log file that a comms manager process running in practice mode writes message activity notifications to.
commsmanager-practice-message-error-YYYYMMDD.log	The log file that a comms manager process running in practice mode writes message error notifications to.
commsmanager-start-YYYYMMDD.log	Console output generated by the comms manager process after it has been started. Used to identify any issues that would have prevented a successful start of the Comms Manager.
dacsimulator-{HOST}-YYYYMMDD.log	The log file that the DAC simulator process writes to. The DAC simulator is generally started alongside a comms manager in practice mode.
dacsimulator-{HOST}-console-YYYYMMDD.log	Console output generated by the DAC simulator after it has been started. Used to identify any issues that would have prevented a successful start of the DAC simulator.
dactransmit-{TRX}-YYYYMMDD.log	The log file that a DAC transmit process writes to. Each DAC transmit process broadcasting to a specific Transmitter, <i>TRX</i> , will have its own log file.
dactransmit-{TRX}-console-YYYYMMDD.log	Console output generated by a DAC transmit process broadcasting to Transmitter, <i>TRX</i> .
dactransmit-{TRX}-message-activity-YYYYMMDD.log	The log file that a DAC transmit process, broadcasting to Transmitter <i>TRX</i> , writes message activity notifications to.
dactransmit-{TRX}-message-error-YYYYMMDD.log	The log file that a DAC transmit process, broadcasting to Transmitter <i>TRX</i> , writes message error notifications to.
dactransmit-maintenance-{TRX}-YYYYMMDD.log	The log file that a DAC transmit process, broadcasting to Transmitter <i>TRX</i> , running in maintenance mode writes to.
dactransmit-maintenance-{TRX}-message-activity-YYYYMMDD.log	The log file that a DAC transmit process, broadcasting to Transmitter <i>TRX</i> , running in maintenance mode writes message activity notifications to.
dactransmit-maintenance-{TRX}-message-error-YYYYMMDD.log	The log file that a DAC transmit process, broadcasting to Transmitter <i>TRX</i> , running in maintenance mode writes message error notifications to.

dactransmit-practice-{TRX}-YYYYMMDD.log	The log file that a DAC transmit process, broadcasting to Transmitter <i>TRX</i> , running in practice mode writes to.
dactransmit-practice-{TRX}-console-YYYYMMDD.log	Console output generated by a DAC transmit process, broadcasting to Transmitter <i>TRX</i> , running in practice mode after it has been started.
dactransmit-practice-{TRX}-message-activity-YYYYMMDD.log	The log file that a DAC transmit process, broadcasting to Transmitter <i>TRX</i> , running in practice mode writes message activity notifications to.
dactransmit-practice-{TRX}-message-error-YYYYMMDD.log	The log file that a DAC transmit process, broadcasting to Transmitter <i>TRX</i> , running in practice mode writes message error notifications to.
edex-message-activity-YYYYMMDD.log	The log file that the BMH EDEX instance writes message activity notifications to.
edex-message-error-YYYYMMDD.log	The log file that the BMH EDEX instance writes message error notifications to.
edex-practice-message-activity-YYYYMMDD.log	The log file that the BMH EDEX instance writes practice message activity notifications to.
edex-practice-message-error-YYYYMMDD.log	The log file that the BMH EDEX instance writes practice message error notifications to.

### 32.3 *BMH Configuration*

This section provides an overview of the BMH configuration files (their location and purpose) and also provides step-by-step instructions that will be used to configure BMH for first time use. You will need root access to dx3, dx4, px1, and px2 to complete the configuration of BMH.

#### 32.3.1 *Configuration Overview*

Most of the BMH configuration is located in the /awips2/bmh/conf directory. However, there are also three BMH configuration files located in /awips2/edex/conf/resources including the following files: bmh.properties, bmh-request.properties, and bmh-legacy.properties.

The **bmh.properties** configuration file is used to provide configuration information to the EDEX bmh instance. The following **Table 32.3.1-1** includes a summary and purpose of the properties that are available in this file.



**Table 32.3.1-1: BMH Properties**

Property	Purpose
bmh.tts.threads	The number of NeoSpeech synthesis threads that will be available to the operational BMH components. The standard BMH licenses that we are using allow for 8 synthesis threads; so, by default we allocate 7 threads for operational use and 1 thread for practice use. <i>Default: 7</i>
bmh.thrift.service.port	The port that the EDEX bmh instance will listen to connections from CAVE on. This port should match the port with the same name specified in bmh-request.properties. <i>Default: 9583</i>
bmh.tts.heartbeat	The EDEX bmh instance will frequently check to verify that it is able to connect to and use a NeoSpeech Server. This property is used to specify the amount of time (in milliseconds) to wait between each NeoSpeech availability verification. <i>Default: 120000</i>
bmh.tts.server	The name of the server that NeoSpeech is running on. This property is defaulted to localhost because NeoSpeech will run on both px1 and px2 in a standard operational setup. <i>Default: localhost</i>
bmh.tts.port	The port that NeoSpeech is listening for synthesis requests on. Any changes to this value will require altering the NeoSpeech configuration and restarting the NeoSpeech TTS Server. <i>Default: 7000</i>
bmh.tts.nfs.dir	The directory that NeoSpeech will write temporary synthesized audio files to. EDEX bmh will read the files and use the audio data to create files containing the audio that will be broadcast. Files are initially written to a temporary location just so that we will not need to make multiple requests to the NeoSpeech server to retrieve all audio for larger synthesis requests. <i>Default: /awips2/bmh/neospeech/result</i>
bmh.tts.connect-timeout	The amount of time (in milliseconds) to wait for the NeoSpeech server to respond to a request.

	<b>Default:</b> 6000
bmh.tts.retry-threshold	The maximum number of times to re-attempt a synthesis request after an initial failure. If the request still cannot be processed after the maximum number of attempts, it will be reported as a failure. <b>Default:</b> 15
bmh.tts.retry-delay	The amount of time (in milliseconds) to wait before re-submitting a synthesis request after a previous failure. <b>Default:</b> 20000
bmh.practice.tts.threads	The number of NeoSpeech synthesis threads that will be available to the practice BMH components. <b>Default:</b> 1
bmh.practice.comms.manager.start er	The location and name of the script that will be used to start an instance of the Comms Manager process (refer to section 32.4.1 for additional information about the various BMH processes) in practice mode. <b>Default:</b> /awips2/bmh/bin/commsmanager.sh
bmh.practice.dac.simulator.starter	The location and name of the script that will be used to start the DAC Simulator process. <b>Default:</b> /awips2/bmh/bin/dacsimulator.sh
bmh.practice.dac.simulator.stopper	The location and name of the script that will be used to stop the DAC Simulator process. <b>Default:</b> /awips2/bmh/bin/stop_dacsimulator.sh
bmh.practice.timeout.minutes	The number of minutes that the practice mode Comms Manager and DAC Simulator are allowed to run for after all practice mode CAVES have been closes. <b>Default:</b> 60
eventBusThreadCount	Specifies the number of simultaneous messages that can be submitted within and handled by the system at any moment in time. <b>Default:</b> 2
bmh.audio.max-duration	The maximum duration (in seconds) allowed for audio processed by the BMH system. Defaults to 600 (10 minutes) if unspecified.
bmh.purge.days	The amount of time (in days) retain BMH data before it is automatically purged by the system. <b>Default:</b> 30

bmh.data.reject	The directory that BMH will copy bad data files that it cannot process to. <i>Default:</i> /awips2/bmh/data/nwr/reject
bmh.data.archive	The directory that BMH will copy files that it successfully processed to. <i>Default:</i> /awips2/bmh/data/nwr/archive
bmh.file.limit	The maximum file size that BMH will accept. Can be declared in bytes, MB, or KB. Any files that BMH encounters that are larger than the specified size will be moved to the location specified by the bmh.data.reject property. <i>Default:</i> 100KB

The **bmh-request.properties** configuration file is used to provide configuration information to the BMH components that run in the EDEX request instance. The following **Table 32.3.1-2** includes a summary and purpose of the properties that are available in this file.

**Table 32.3.1-2: BMH-Request.Properties**

Property	Purpose
bmh.host	The name of the server that the EDEX bmh instance is running on or a highly available endpoint that can be used to access the EDEX bmh instance. <i>Default:</i> ec-bmh
bmh.thrift.service.port	The port that the EDEX bmh instance will listen to connections from CAVE on. This port should match the port with the same name specified in bmh.properties. <i>Default:</i> 9583
bmh.comms.manager.port	The port that the operational Comms Manager process will listen on. <i>Default:</i> 18000
bmh.practice.comms.manager.port	The port that the practice Comms Manager process will listen. <i>Default:</i> 18500

Now that an overview of the EDEX-specific BMH configuration has been provided, we will provide an overview of the BMH (mostly non-EDEX) specific configuration files in the /awips2/bmh/conf directory. Configuration files of interest in this directory include: comms-practice.xml (will not exist until BMH has been started in practice mode at least

once), `comms.xml`, `notification.properties`, `unacceptableWords.eng.txt`, and `unacceptableWords.spa.txt`. There are also `logback.xml` and `wrapper.conf` files in this directory but they should only be modified and will only be completely understood by users that are familiar with the Logback FOSS and the Yet Another Java Service Wrapper FOSS respectively.

The **`comms.xml`** configuration file is used to configure the operational Comms Manager process and the operational DAC Transmit processes (when applicable). A user should only need to manually edit this file prior to the initial start of BMH (as we will do in Section 32.3.2). In all other cases, EDEX will automatically update this file whenever BMH configuration is modified.

The **`comms-practice.xml`** configuration file is used to configure the practice Comms Manager process and the practice DAC Transmit processes (when applicable). The user should never need to manually modify this file. An initial version of the file will be created the first time BMH is used in practice mode and EDEX will automatically update this file whenever BMH practice configuration is modified.

The **`notification.properties`** configuration file is explained in greater detail in Section 32.3.3.1 of this document.

The **`unacceptableWords.eng.txt`** and the **`unacceptableWords.spa.txt`** configuration files are used to define unacceptable words for the English language and the Spanish language respectively that will be flagged by the system. Any message containing unacceptable words will not be fully processed by the system. The words in the files are arranged such that each line contains a single unacceptable word.

The **`neospeechCorrect.eng.txt`** and the **`neospeechCorrect.spa.txt`** configuration files are used to define dictionary words for the English language and the Spanish language respectively that NeoSpeech already currently pronounces correctly. Any words in these files will be filtered out of the total list of words to convert whenever a user initiates the legacy dictionary conversion process. The words in the files are arranged such that each line contains a single word that will be filtered out.

### 32.3.2 *Configure EDEX BMH*

1. Access the primary EDEX server.
  - `ssh root@dx3`
2. `cd /awips2/edex/bin`
3. `scp setup.env root@px1:/awips2/edex/bin`
4. `scp setup.env root@px2:/awips2/edex/bin`

### 32.3.2.1 BMH Notification Configuration

The BMH software includes a configurable notification system. This notification system can be used to influence how the system should react to certain events based on the type of event and the severity of the event.

The configuration file for the BMH notification system is located at: **/awips2/bmh/conf/notification.properties**. Refer to the file header for additional information about how to configure BMH notifications.

The **Table 32.3.2.1-1** below provides a summary of the event types that are recognized by the BMH notification system.

**Table 32.3.2.1-1: Summary of Event Types**

Category Code	Category	Description
0	SUCCESS	Indicates a successful operation.
1	TTS_CONTINUE	Specific to the TTS Components: indicates that additional data can be read from the TTS Server.
2	TTS_SOFTWARE_ERROR	Specific to the TTS Components: used to indicate that a TTS operation has failed due to a software or API issue (ex: invalid input).
3	TTS_SYSTEM_ERROR	Specific to the TTS Components: used to indicate that a TTS operation has failed due to a system or server error outside the jurisdiction of the TTS Software and/or TTS components (ex: disk full, networking problems, etc.)
4	TTS_FATAL_ERROR	Specific to the TTS Components: an error that cannot be recovered from.
5	TTS_CONFIGURATION_ERROR	Specific to the TTS Components: used to indicate that the TTS components were not configured correctly.

6	INPUT_MESSAGE_PARSE_ERROR	Specific to the input message parser. Used to indicate that the parser cannot understand the format of the input.
7	MESSAGE_VALIDATION_ERROR	Specific to the message validation component: used to indicate that an unexpected error occurred during validation.
8	MESSAGE_VALIDATION_FAILED	Specific to the message validation component: used to indicate that a message has failed validation.
9	XFORM_MISSING_MSG_TYPE	Specific to the Message Transformation Components; used to indicate that an afos id was encountered without an associated message type.
10	XFORM_MISSING_DICTIONARY	Specific to the Message Transformation Components; used to indicate that a transmitter group, language combination was encountered that did not have an associated dictionary.
11	MESSAGE_AREA_UNCONFIGURED	Specific to the message validation component: used to indicate that a message area is not in the configuration.
12	XFORM_SSML_GENERATION_FAILED	Specific to the Message Transformation Components; used to indicate that SSML Generation failed when attempting to transform a message using a dictionary.
13	PLAYLIST_MANAGER_ERROR	An error has occurred adding a message to a playlist.
14	TRANSMITTER_STATUS_ERROR	An error has occurred while tracking the status of a transmitter.
15	COMMS_CONFIGURATOR_ERROR	An error has occurred while configuring the comms manager.
16	STATIC_MSG_ERROR	An error has occurred during static

		message generation.
17	COMMS_MANAGER_ERROR	The Comms Manager has failed to complete an operation.
18	DAC_TRANSMIT_ERROR	Failed to transmit data on the DAC.
19	DAC_TRANSMIT_SILENCE	Nothing has been broadcast to the DAC.
20	LDAD_ERROR	An error has occurred during ldad processing.
21	DAC_TRANSMIT_BROADCAST_DELAY	Indicates that a warning or interrupt cannot be broadcast on a transmitter due to an active broadcast live session.
22	AUDIO_TRUNCATED	Indicates that audio has been truncated because its duration exceeded the maximum allowed duration.
23	EXCESSIVE_FILE_SIZE	Indicates that an incoming file has been discarded because its size was greater than the maximum allowed size.
25	SAME_DURATION_TRUNCATION	Indicates that a SAME Message has been truncated to two minutes during the initial broadcast.
26	SAME_AREA_TRUNCATION	Indicates that one or more areas have not been included in a SAME tone, because the maximum number of areas has been exceeded.
27	WTCH_OR_WRN_NOT_BROADCAST	Indicates that a watch or warning message has expired before it could be broadcast.
28	MESSAGE_VALIDATION_EXPIRED	Indicates that a message failed validation because it was already expired upon arrival.
29	MESSAGE_VALIDATION_UNPLAYABLE	Indicates that a message failed validation because it was not eligible for playback on any of the

		existing transmitter groups due to the fact that it was not found in any of the geographical areas recognized by the existing transmitter groups.
30	MESSAGE_VALIDATION_UNDEFINED	Indicates that a message failed validation because an associated message type was not found in the system.
31	MESSAGE_VALIDATION_UNASSIGNED	Indicates that the message failed validation because the associated message type is not in any suites associated with the transmitter groups eligible for playback indicated by the geographical areas associated with the message.
32	MESSAGE_VALIDATION_DUPLICATE	Indicates that a message failed validation because it was a duplicate of a message that had been previously processed.
33	MESSAGE_VALIDATION_UNACCEPTABLE	Indicates that a message failed validation because it contained unacceptable words.
34	MESSAGE_ARCHIVE_FAILED	Indicates that a message failed to copy to the archive.
35	DAC_SYNC_ISSUE	Indicates that a DAC and BMH Database are out of sync.
36	DAC_SYNC_VERIFY_FAIL	Indicates that an attempt to verify that the BMH database are in sync with the DACs has failed.
500	LEGACY_DATABASE_IMPORT	Specific to the legacy database import. Used to indicate an issue occurred with the legacy database import.
1000	INTERRUPTED	Indicates that a thread has been interrupted while performing some action.
9999	UNKNOWN	Indicates a failed operation with an



		unknown or unclear cause.
--	--	---------------------------

### 32.4 BMH Process Management

Now that BMH has been successfully configured, this section will provide an overview of the various BMH processes and provide instructions for starting and stopping the BMH processes.

#### 32.4.1 BMH Process Overview

The following **Table 32.4-1** lists the various processes that are part of the BMH system. All of the processes listed run on px1 and/or px2.

**Table 32.4-1: BMH Processes**

Process	Description
TTS Server	COTS software purchased from NeoSpeech. Used to synthesize the audio data that will be broadcast.
DAC Transmit	Responsible for scheduling playlist messages and broadcasting audio data to the DAC. There will be one DAC transmit process per Transmitter.
Comms Manager	Provides a way for Viz and Edex to communicate with the DAC Transmit processes. Responsible for starting / stopping DAC transmits processes based on configuration changes as well as load balancing the DAC transmit processes when used in clustered mode. Receives the outbound audio from the DAC and forwards to CAVE for inline monitoring.
BMH EDEX	An EDEX instance that is specific to BMH: <ul style="list-style-type: none"> <li>● Reads and validates messages placed in: /awips2/bmh/data/nwr/ready</li> <li>● Determines the destination transmitters for the data</li> <li>● Interacts with the TTS Server to synthesize the audio data that will need to be broadcast</li> <li>● Builds playlists</li> <li>● Initializes and updates (as needed) the configuration used by the Comms Manager</li> <li>● Sends the playlists to the Comms Manager (so that</li> </ul>

	<p>they can be forwarded to the appropriate DAC transmit process)</p> <ul style="list-style-type: none"> <li>● Keeps track of the messages and playlists that are currently playing so that the information can be provided to Viz clients.</li> <li>● Handles requests to retrieve and update the BMH data</li> </ul>
--	------------------------------------------------------------------------------------------------------------------------------------------------------------------------------------------------------------------------------------------------------------------------------------------------------------------------

### 32.4.2 Start the BMH System

This section provides step-by-step instructions that should be used to start the BMH processes. The TTS Server and Comms Manager are configured to autostart when the PX boots. If they need to be manually started the information is below. BMH EDEX is not automatically launched due to its dependence on PostgreSQL and Qpid. This instruction set assumes that you have already started PostgreSQL and Qpid.

1. Start Comms Manager.
  - ssh root@px1
  - /sbin/service comms\_manager start
  - Check the commsmanager logs in /awips2/bmh/logs and verify that Comms Manager successfully starts.
  - ssh root@px2
  - /sbin/service comms\_manager start
  - Check the commsmanager logs in /awips2/bmh/logs and verify that Comms Manager successfully starts.
2. Start the TTS Server processes.
  - ssh root@px1
  - cd /awips2/bmh/neospeech/bin
  - /bin/bash ttssrv\_start
  - ssh root@px2
  - cd /awips2/bmh/neospeech/bin
  - /bin/bash ttssrv\_start
3. Start the BMH EDEX processes.
  - ssh root@px1
  - /sbin/service edex\_camel start bmh
  - Check the bmh-edex logs in /awips2/edex/logs and verify that the BMH EDEX instance successfully starts.
  - ssh root@px2
  - /sbin/service edex\_camel start bmh

- Check the bmh-edex logs in /awips2/edex/logs and verify that the BMH EDEX instance successfully starts.

### 32.4.3 Stop the BMH System

This section provides step-by-step instructions that should be used to stop the BMH processes. These steps should be completed before stopping PostgreSQL or Qpid.

1. Stop the BMH EDEX processes.
  - ssh root@px2
  - /sbin/service edex\_camel stop bmh
  - ssh root@px1
  - /sbin/service edex\_camel stop bmh
2. Stop Comms Manager.
  - ssh root@px2
  - /sbin/service comms\_manager stop
  - ssh root@px1
  - /sbin/service comms\_manager stop
3. Stop the TTS Server processes.
  - ssh root@px2
  - cd /awips2/bmh/neospeech/bin
  - /bin/bash ttssrv\_stop
  - ssh root@px1
  - cd /awips2/bmh/neospeech/bin
  - /bin/bash ttssrv\_stop

### 32.4.4 BMH Practice Mode

When a user launches the BMH dialog in a practice mode CAVE, BMH EDEX launches a practice mode Comms Manager and a DAC Simulator on each box where BMH EDEX is running (px1/px2). When a user exits the practice mode BMH, they are given the option of stopping the practice mode processes. If the user chooses to not shut down the processes, they will automatically timeout and shutdown after `bmh.practice.timeout.minutes`, default of 60 minutes. If the processes fail to stop, they will need to be manually killed.

- ssh root@px1
- ps -ef | grep java | grep -i practice
- kill -9 <PIDS>

- `ssh root@px2`
- `ps -ef | grep java | grep -i practice`
- `kill -9 <PIDS>`

### 32.5 *Configuring the DAC*

Now that the BMH software has been configured and started, the final step is to set up the DACs that the BMH components will connect to and interact with to broadcast audio.

**Note: This section will only cover configuring the DAC after it has been connected to the network and powered on.** See Section 32.6.4, or AWIPS Modification Note 80, for instructions on how to install the DAC hardware.

1. On the LX workstation, start a CAVE session.
2. From the D2D perspective, select **CAVE**, then select **BMH**.
3. From the *BMH* menu, select **Maintenance** and choose **DAC Configuration**. The list of available DACs will appear; if this is the first DAC to be added, the list will be empty.
4. Select **New**.

The *Create DAC Configuration* screen will already be populated with the proper values for the next DAC. For instance, if this is the first DAC to be installed, the *DAC Name* will be **dac1**, *DAC IP Address* will be 10.2.69.101, etc. (see Exhibit 32.5-1). Make sure the Auto-Configure box is checked; this tells BMH to save these values both to the AWIPS database and on the DAC itself.

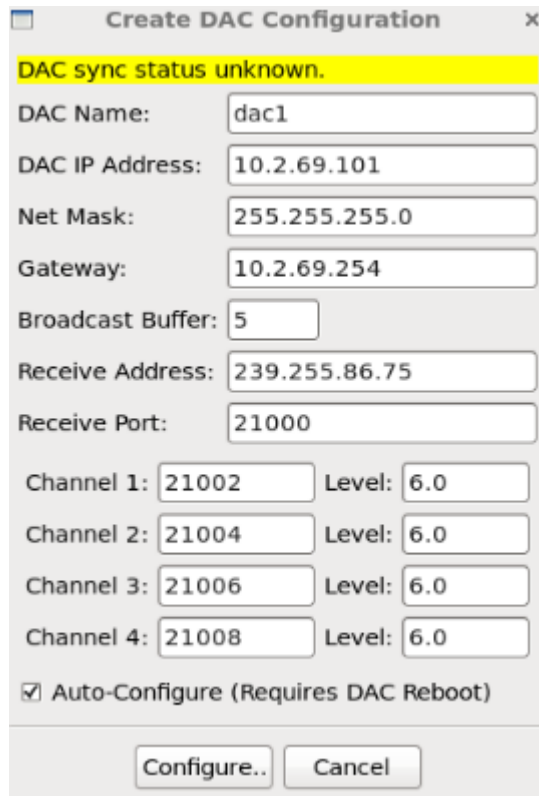

**Exhibit 32.5-1: New DAC Configuration screen**

5. Select **Configure...**
6. The *Configure DAC* dialog displays prompting the user for the IP Address of the DAC to be configured (only when Auto-Configure is checked) (see Exhibit 32.5-2).

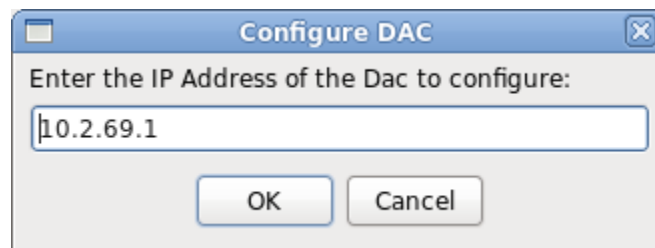

**Exhibit 32.5-2: Configure DAC screen**

The dialog is preset with the factory default Internet Protocol (IP) address with which the DAC ships. If this is a newly installed DAC, it will respond to this address.

7. Select **OK**. A progress window (see Exhibit 32.5-3) displays while BMH saves the settings to the database, sets those values in the DAC device, and reboots the DAC to make the new values effective.

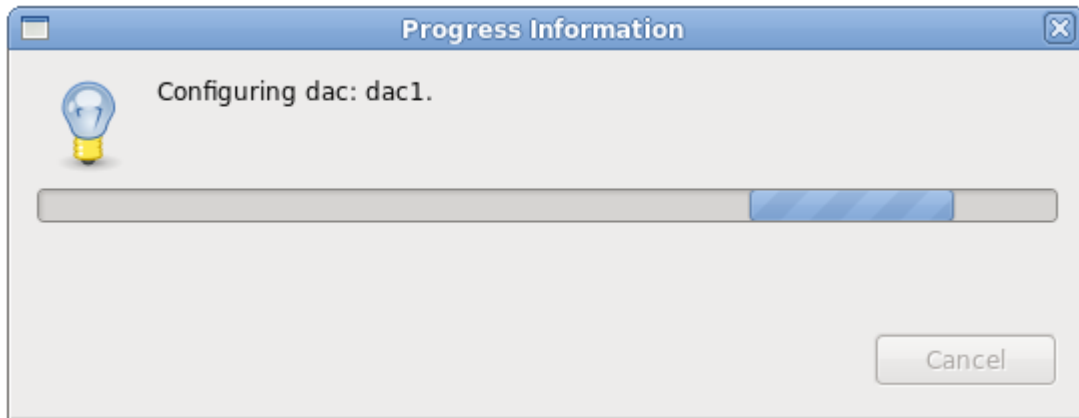

**Exhibit 32.5-3: Progress screen**

8. When DAC configuration is complete, the *DAC Configuration* screen displays again; it will now include the new DAC (see Exhibit 32.5-4). Note that the DAC no longer has the default IP address **10.2.69.1**; it now responds to the address set in Step 4.

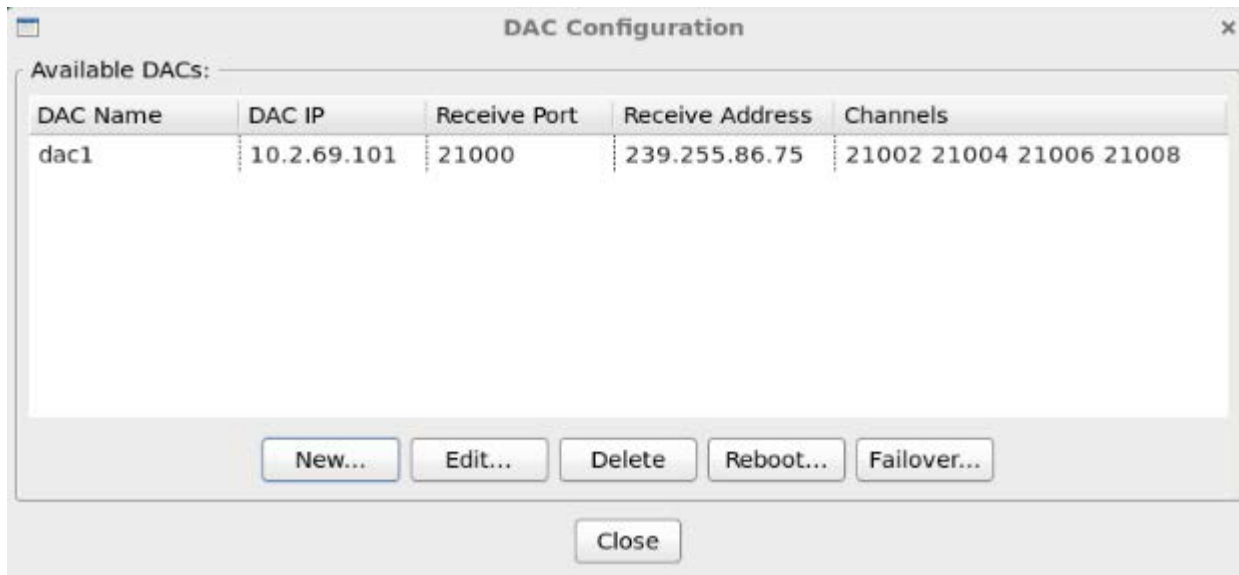

**Exhibit 32.5-4: DAC Configuration screen**

### 32.6 *Failing over to the spare DAC*

Each WFO is initially provisioned with a spare DAC. During BMH Deployment, this DAC would have been installed along with the others in Rack 1, powered up, connected to the AWIPS LAN, and configured with the appropriate IP address and other settings. This minimizes the amount of time necessary to bring the spare DAC online so the transmitters may resume their broadcast. This section lays out the steps to remove the failed DAC from service, and switch its transmitters and their programs to the spare DAC.

Although most of this procedure needs just the DAC Configuration screen of the CAVE BMH menu, there are two steps which must be performed by hand:

- Unplugging the failed DAC from its power supplies;
- Moving the RJ11 cables going to the transmitters from the back of the failed DAC to the spare.

*Note:* This procedure is applicable also to failing over to a replacement DAC received from NLSC, once it is mounted in Rack 1 and connected to power and cables. The only difference is that the factory default IP address for the new DAC is **10.2.69.1**.

#### 32.6.1 *Determining whether a DAC is malfunctioning*

There are a number of situations in which BMH will report errors occurring on a DAC device; many of them are transient and will resolve on their own, or by restarting BMH-related processes, and do not necessarily mean that the DAC hardware is defective. Always contact the NCF to attempt basic diagnosis and recovery steps before failing over to the spare DAC.

Some basic steps to determine if the DAC is malfunctioning:

- Make sure both power cables and both network cables are plugged into the front of the DAC firmly (see Exhibit 32.6-1).
- Check the indicator lights on the back of the DAC. If the lights are off, blinking red (except briefly while the DAC is booting), or steady red, that indicates a hardware problem. A blinking yellow light indicates that the DAC is functioning normally, but only one power supply is supplying power; a green light indicates that the DAC is working normally. (Note that the green and yellow colors are very similar in the DAC LED.)
- Unplug an ordinary telephone handset from its base. Plug the cable into one of the RJ11 ports on the back of the DAC and listen. If the DAC is functioning properly, you will hear either the standard radio transmission, or the canned “Off the air” message.
- From any LX workstation, **ssh px1** (or **ssh px2**) and ping the DAC using its IP address:  
**ping 10.2.69.10X** where X is the number of the DAC; e.g., for DAC2,  
**ping 10.2.69.102**  
If the DAC is functioning and properly connected, it should respond within a

second with an indication of the number of bytes received.

- Finally, try connecting to the DAC web server.
  - Log into any Linux Workstation (LX) and open a terminal session.
  - Type `ssh -x px1`
  - From PX1, type `firefox` to open the web browser.
  - In the browser line, type `https://10.2.69.10x` where X is the DAC number.
    - Select **I understand the risks**
    - Select **Add exceptions**
    - Select **Confirm security exception**
  - If the DAC is functioning properly, the login screen will appear.

These are very basic health checks, and might miss subtle or intermittent problems with the DAC.

### 32.6.2 Remedial actions

Before concluding that an unresponsive DAC must be replaced, try the following:

- From the BMH Menu, open **DAC Configuration...**, select the faulty DAC, and hit the **Reboot...** button. If the reboot is successful, the DAC should return to normal function in about a minute.
- If the reboot is unsuccessful, cycle power on the DAC, as follows:
  - Locate the power cables on the front of the DAC (Exhibit 32.6-1).
  - Unplug *both* cables. Wait about 15 seconds.
  - Plug both cables back in. Wait about a minute.

If successful, the LED will flash for about thirty seconds, then turn steady green. Soon thereafter, BMH processes will reestablish communications with the DAC, and it will resume normal operation.

### 32.6.3 Failover procedure

For this example, assume that the WFO has 7 directly connected transmitters; this means there are two active DACs and one spare. Assume that the device which has failed is **dac1**.

- 1) Locate the failed DAC in Rack 1. (In this example, **dac1** is the topmost. Each DAC has an identifying label.)
- 2) Unplug **both** power cables from the failed DAC. Power cables are on the front of the device on the right side, and are accessed from the front of the cabinet. It is important to unplug the failed device to prevent conflicts in network addressing later on.



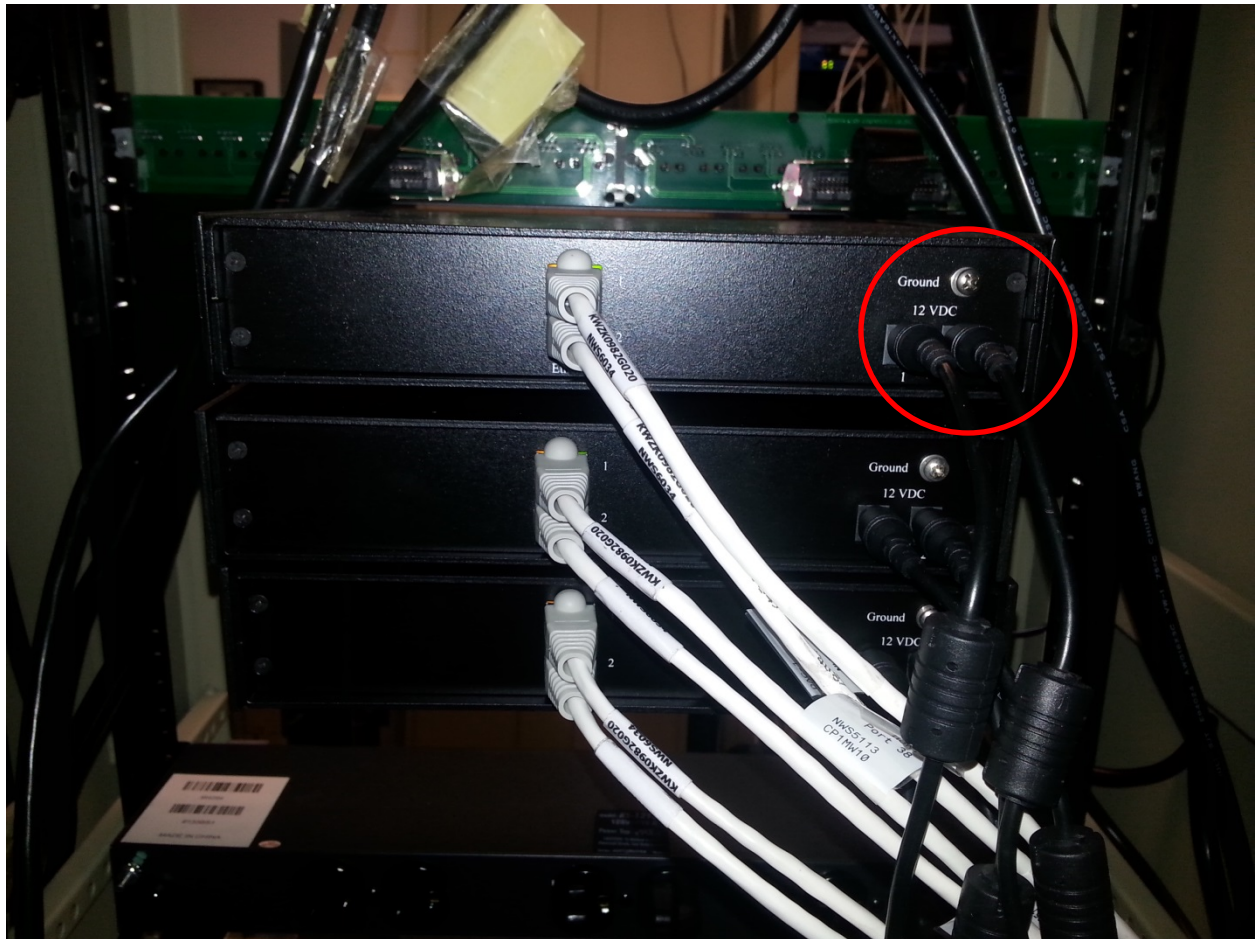

**Exhibit 32.6-1 Front view of Rack 1; circle indicates power cables for DAC1**

- 3) Log into any LX workstation as a user with BMH Administrator privileges.
- 4) Start CAVE, and select **File / BMH Menu**.
- 5) From the **Maintenance** menu, select **DAC Configuration ...** A screen like the following will display:

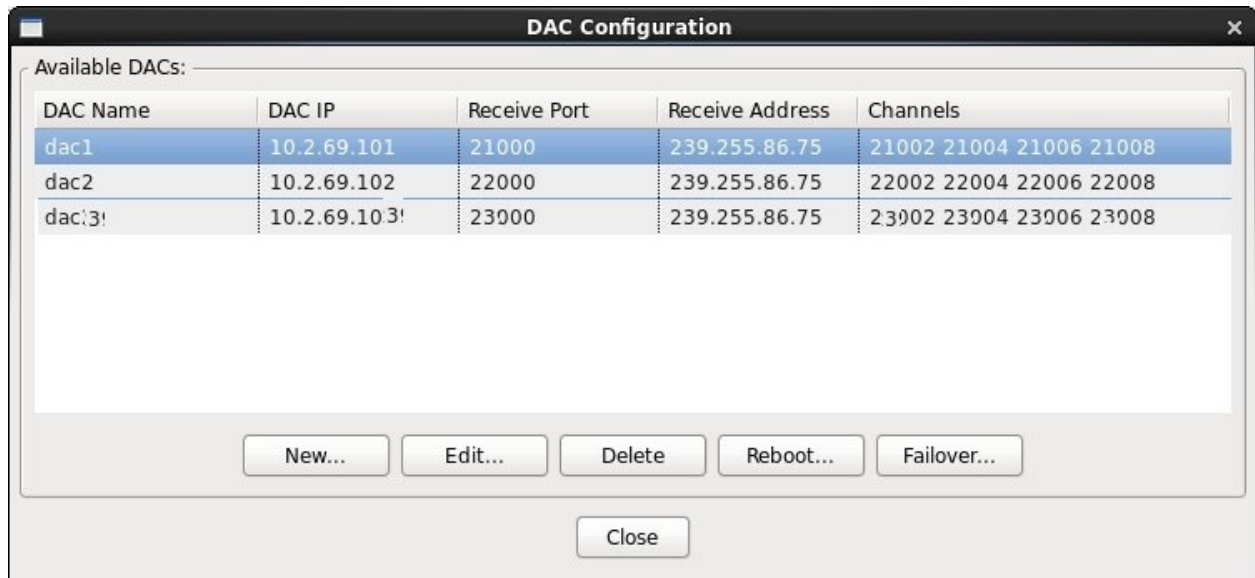

**Exhibit 32.6-2 DAC Configuration screen, showing two active DACs and one spare**

- 6) Note the **IP** address for the last DAC on the list – in this example, **dac3**, with IP address **10.2.69.103**. This is the spare DAC; it should have no transmitters assigned to it.
  - a. The number of DACs vary by site; but if BMH was installed as outlined in the Mod Note, the last DAC will always be the spare.
- 7) Select the failed device (in this example, **dac1**), and click **Failover...**
- 8) CAVE will ask whether the failed DAC has been unplugged. Confirm that this is true, then click **Yes**.



**Exhibit 32.6-3 Confirm that the failed DAC is unplugged before proceeding**

- 9) This will bring up the **Configure DAC** screen.

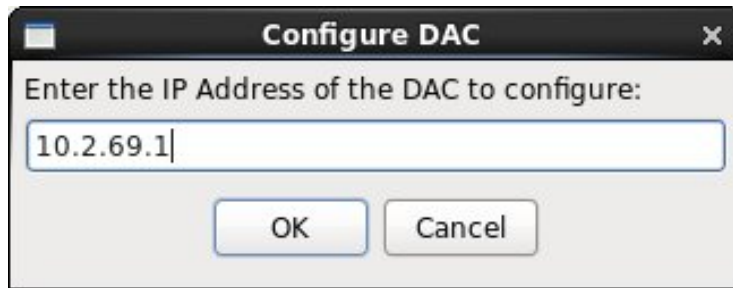

**Exhibit 32.6-4** Configure DAC pop-up, with default address

- 10) By default, the IP address is set to the factory default address with which new DACs are shipped. Change this to the address of the spare DAC, as noted in Step 6.



**Exhibit 32.6-5** Enter the address of the spare DAC

- 11) BMH will configure the spare DAC and update the AWIPS database. This may take 1-2 minutes.

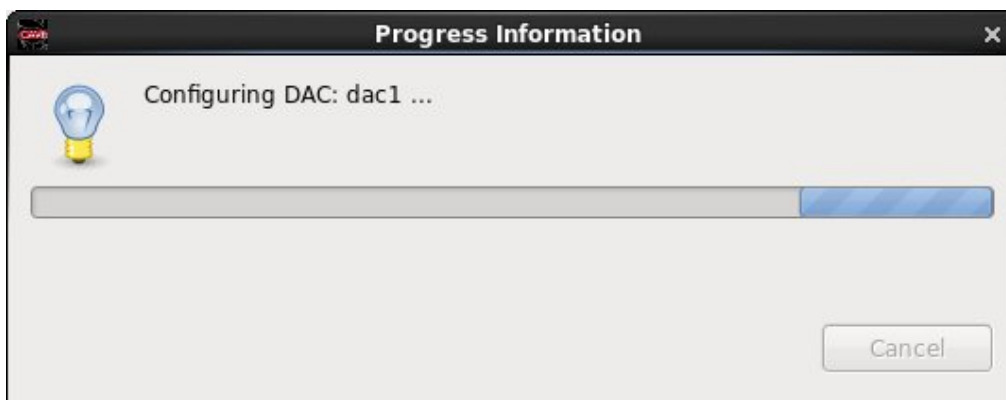

**Exhibit 32.6-6** DAC Configuration progress screen

- 12) When configuration is finished, a status window will confirm that it was successful. Click **Close** to go back to the **DAC Configuration** screen.

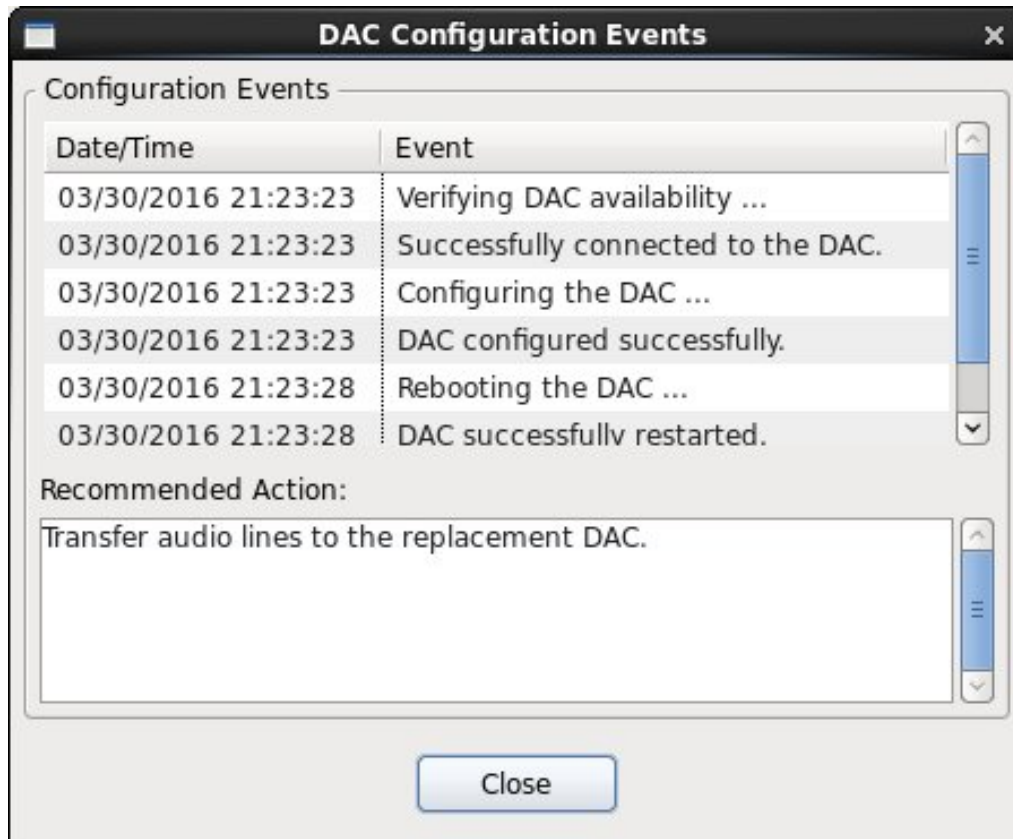

**Exhibit 32.6-7** Status screen showing whether spare DAC was successfully configured

13) BMH now only recognizes two DACs in its configuration.

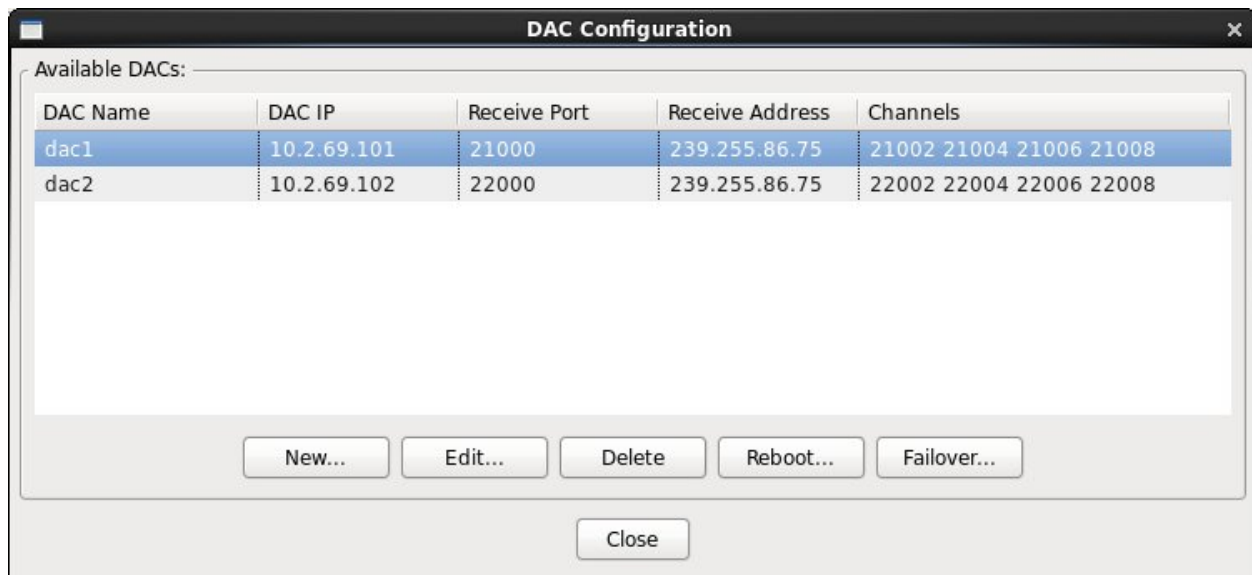

**Exhibit 32.6-8** DAC Configuration screen after failover

14) BMH is now broadcasting the programs which formerly played on the failed DAC on the spare. You can check this by using the Broadcast Cycle to monitor the transmitters

in-line. For the final step, unplug each RJ11 connector from the output ports on the failed DAC labeled **Radio1**, **Radio2**, **Radio3**, and **Radio4**; and move it to the corresponding port on the spare. *Make sure you maintain the same order*, or broadcasts will be sent to the wrong transmitter.



**Exhibit 32.6-9** Connections to transmitters from failed DAC



**Exhibit 32.6-10** After failover: manually move connectors to spare DAC, preserving original order

15) Normal broadcast operations are now restored.

Note that the labels on what was the "spare" DAC are now incorrect. In this example, they identify it as DAC3 with IP address 10.2.69.103; a new label should be handwritten to identify it as the DAC it replaced -- in this example, DAC1 / 10.2.69.101.

Also, after the failed device is removed in the next step, the DACs will no longer necessarily be in the same physical order; in this example:

DAC1
DAC2
DAC3

... will be replaced with:

[empty]
DAC2
DAC1

It might save future confusion to move the reconfigured spare DAC into the empty slot, thus preserving the order when the replacement DAC is received; however, the transmitters connected to this DAC would be silent for the several minutes while it is being moved, since it would need to be disconnected from power during that time.

### 32.6.4 *Installing the replacement DAC*

After failover, the faulty DAC needs to be replaced, in order to maintain an on-site spare. Use the CLS system to order a replacement from NLSC. Once it is received, follow these steps to install it and get it ready for use.

- 1) Remove the new DAC from the box, along with its mounting brackets, and set aside.
- 2) Unplug the failed DAC from its network cables (it should already be disconnected from power). Do not disconnect the network cables from the HSW; keep them handy for use with the replacement.
- 3) Unmount the failed DAC from Rack 1. You may unscrew the mounting brackets, but replace the screws in the DAC. Pack the DAC, its two power supplies, and the mounting brackets, and pack them in the box in which the new DAC was shipped. Enclose a short note indicating the reason for failure and the last known IP address.
- 4) Remove the four feet from the bottom of the new DAC.
- 5) Remove the four outside screws from one side of the DAC and set aside.
- 6) Attach one of the two rack mount brackets to the side of the DAC using the four screws removed previously, making sure the front edge of the bracket lines up with the front edge of the DAC.
- 7) Repeat Steps 5 and 6 for the other bracket on the other side of the DAC.
- 8) Mount the new DAC in Rack 1 in the position vacated by the failed DAC.
- 9) Plug in both CAT-Ve network cables previously connected to the failed DAC.
- 10) Plug both new power supplies into the power strips in the previous positions. **DO NOT** reuse the power supplies from the failed DAC, in case they were involved in the malfunction. Plug the power supplies into the front of the DAC.
- 11) Wait about thirty seconds. The DAC LED will flash red briefly, then blink yellow as it is booting, and should finally turn a steady green.
- 12) Log into any LX workstation and start CAVE.
- 13) From the *BMH* menu, select **Maintenance** and choose **DAC Configuration**. The list of available DACs should show all of the current operational DACs for your site (similar to Figure 32.6-8).
- 14) Click the **New...** button. The *Create DAC Configuration* screen will appear, and already be populated with the proper values for the next DAC. For instance, if your site has two DACs configured and you have just installed the third, the settings on the screen will be: DAC Name: **dac3**, DAC IP Address: **10.2.69.103**, etc. Make sure the **Auto-Configure** box is checked.
- 15) Select **Configure ...**

- 16) The *Configure DAC* dialog displays prompting the user for the IP Address of the DAC to be configured. The dialog is prepopulated with factory default DAC IP address, which is **10.2.69.1**. This is the correct address, so click **OK**.
- 17) A progress window displays while BMH saves the settings to the database, sets those values in the DAC device, and reboots the DAC to make the new values effective.
- 18) When DAC configuration is complete, the *DAC Configuration* screen displays again. It will now include the new DAC. Note that the DAC no longer has the default IP address 10.2.69.1; it now responds to the address set in Step 14.

A label should be handwritten to properly identify this unit as **DACX**, IP address **10.2.69.10X**, where X is the new DAC number.

If the new DAC needs to immediately replace a malfunctioning DAC, follow the instructions in Section 32.6.3.



# **Appendix A**

## **Abbreviations and Acronyms**

μEngine

MicroEngine

**A**

AAP	Alert Adaptation Parameter
ACARS	Aircraft Communications Addressing and Reporting System
ACN	AWIPS Communications Network
ACT	Attribute Color Threshold
ADAPPT	AWIPS Decision Assistance Production Preparation Tools
ADE	AWIPS Development Environment
AFD	Area Forecast Discussion
AFOS	Automation of Field Operations and Services
AGMG	AWIPS GIS Mapping Group
AHPS	Advanced Hydrologic Prediction Service
ALERT	automated local evaluation in real time
AM	Alert Message
AMQP	Advanced Message Queuing Protocol
ANCF	AWIPS Network Control Facility (Silver Spring, MD)
ANSI	American National Standards Institute
ANT	Another Neat Tool, a Java-oriented “build” tool
API	application program interface
ARI	Average Recurrence Interval
APS	Asynchronous Product Scheduler
ASCII	American Standard Code for Information Interchange
ASOS	Automated Surface Observing System
AVN	Aviation model
AvnFPS	Aviation Forecast Preparation System
AWC	Aviation Weather Center
AWIPS	Advanced Weather Interactive Processing System
AX	Archive Server

**B**

BBS	Bulletin Board Service
BMGS	Backup Master Ground Station
BMH	Broadcast Message Handler
BNCF	Backup NCF (Fairmont, West Virginia)
BSD	Berkeley Software Distribution
BUFR	Binary Universal Form for data Representation

**C**

CAVE	Common AWIPS Visualization Environment
CCF	NWS Central Collection Facility
CDD	cooling degree days
CFC	Clutter Filter Control
CGI	Common Gateway Interface
CLI	command line interface
CM	Configuration Management
CO	Communications Server
COMT	COMET (WFO Configuration)
CONUS	conterminous United States
COOP	Continuity of Operations
COTS	commercial off-the-shelf
CP	communications processor
CPSBN	Communications Processor - Satellite Broadcast Network
CPU	central processing unit
CPSYNC	Synchronous Communication Processor
CRS	Console Replacement System
CS	Call System
CSCI	Computer Software Configuration Item
CSU	channel service unit
CSVText	Comma Separated Values Text
CWA	county warning area
CWSU	Center Weather Service Unit
CY	calendar year
CZ	Composite Reflectivity
CZC	Composite Reflectivity Contour

**D**

D2D	Display 2-Dimensional
DAT	digital audiotape
DBMS	database management system
DCP	Data Collection Platform
DDR	Double Data Rate
DGEX	Downscaled GFS and Eta Extension Grids
DHR	Digital Hybrid Scan Reflectivity
DMD	Digital Mesocyclone Display
DMS	Data Monitoring System
dpi	dots per inch

DS	HP-UX Data Server
DSM	Daily Summary Message
DSU	digital service unit
DTG	Date Time Group
DTMF	dual tone multifrequency
DTS	dedicated transmission service
DVB	Digital Video Broadcast
DVD	Digital Video Display
DVD-R	Digital Video Display (Read Only)
DX	Linux Data Server

## E

ebRS 4.0	ebXML RegRep 4.0 Services and Protocols specification
ECMWF	European Centre for Medium-Range Weather Forecasts
EDEX	Environmental Data EXchange
EET	Extreme Echo Tops
EHB	Engineering Handbook
EIA	Electronics Industry Association
EMDS	Emergency Manager Decision Support
EMDS	Emergency Managers Dissemination Service
EMM	Enclosure Management Module
EMRS	Engineering Management Reporting System
ENP	Eastern North Pacific
EOF	end of file
EOR	end of report
EPSS	Enhanced Packet-Switched Service (an FTS2000 service)
ERA	Embedded Remote Access
ERL	Environmental Research Laboratory
ESA	electronic systems analyst
ESRL	Earth System Research Laboratory
ET	echo top
ETC	echo top contour

## F

FAA	Federal Aviation Administration
FAC	File Access Controller
FC	Fibre Channel
FDDI	Fiber Distributed Data Interface
FDMA	Frequency Division Multiple Access

FFMP	Flash Flood Monitoring and Prediction
FFG	Flash Flood Guidance
FFFG	Forced Flash Flood Guidance
FFTI	Flash Flood Threat Index
FFW	Flash Flood Warning
FMH	Federal Meteorological Handbook
FOSS	Free and Open Source software
FR	frame relay
FSI	Four-dimensional Stormcell Investigator
FSL	Forecast Systems Laboratory
FSR	Field Site Representative
FTM	Free Text Message
<b>G</b>	
GB	gigabyte
GCI	General Communication, Inc.
GELT	Geographic Entity Lookup Table
GFE	Graphical Forecast Editor
GFS	Global Forecast System
GHz	Gigahertz
GIF	Graphics Interchange Format
GINI	GOES Ingest NOAAPORT Interface
GIS	Geographic Information Systems
GMT	Greenwich Mean Time
GNOME	GNU Network Object Model Environment
GOES	Geostationary Operational Environmental Satellite
GRE	Generic Routing Encapsulation
GRIB	gridded binary (data format)
GSD	Global Systems Division
GSI	Globecomm Systems Inc.
GSM	general status message
GUARDIAN	General User Alert Display Panel
GUI	graphical user interface
GWW	Global Wind and Wave
<b>H</b>	
HDD	Hard Disk Drive
HDLC	High-Level Data Link Control
HDF	Hierarchical Data Format

HDW	High Density Winds
HDSS	Hierarchical Data Storage System
HFS	Hierarchical File System
HFS	Hydrologic Forecast System
HP	Hewlett-Packard
HPC	Hydrometeorological Prediction Center
HPE	High-resolution Precipitation Estimator
HRAP	Hydrologic Rainfall Analysis Project
HRRR	High Resolution Rapid Refresh
HSR	Hybrid Scan Reflectivity
HWO	Hazardous Weather Outlook (replaces or augments the SPS)
HWR	Hourly Weather Roundup

**I**

I/O	input/output
ICAO	International Civil Aviation Organization
ICP	Intelligent Communications Processor
ICWF	Interactive Computer Worded Forecast
IOC	Initial Operating Capability
IEEE	Institute of Electrical and Electronics Engineers, Inc.
IFL	interfacility link
IFLOWS	Integrated Flood Observing and Warning System
IFPS	Interactive Forecast Preparation System
IGC	Inter-Gateway Communication
IHFS	Integrated Hydrologic Forecast System
IMET	Incident METeorologist
IP	Internet Protocol
IPC	Interprocess Communication
IPVS	IP Virtual Server
ISDN	Integrated Services Digital Network
ISS	Incident Support Specialist
IT/O	HP OpenView Operations (old acronym)
IV&V	Independent Verification and Validation

**J, K**

JAI	Java Advanced Imaging
JAI Imageio	Java Advanced Imaging Image I/O tools API
JMS	Java Messaging System
JRE	Java Runtime Environment

JSO	Java Serialized Object
JVM	Java Virtual Machine
<b>L</b>	
LAC	Listening Area Code
LAMP	Local AWIPS MOS Program
LAN	Local Area Network
LAPD	Link Access Procedure-D
LAPS	Local Analysis and Prediction System
LARC	local automatic remote collector
LCD	Liquid Crystal Display
LDAD	local data acquisition and dissemination
LDM	Local Data Manager
LED	light-emitting diode
LDM(D)	Local Data Manager (Downstream)
LIIT	Long Island International Teleport
LNB	low-noise block
LS	LDAD server
LST	local standard time
LTO	Linear Tape Open (a technology)
LV	logical volume
LX	Linux workstation
<b>M</b>	
mb	millibar
MB	megabyte
MDL	Meteorological Development Laboratory (formerly TDL)
MDP	Mesocyclone Display Parameters
METAR	Aviation Routine Weather Report
MGS	Master Ground Station
MHS	Message Handling System
MicroART	Microcomputer Automated Radio Theodolite
MIDDS	Meteorological Interactive Data Display System
MIPS	million instructions per second
MOS	model output statistics
MPE	Multisensor Precipitation Estimator
MPLS	Multi-Protocol Label Switching
MRMS	Multiple-Radar / Multiple-Sensor
MSAS	MAPS Surface Analysis System

MSM	Monthly Summary Message
MTA	Message Transfer Agent
MTP	multipoint-to-point
MTSATHDW	Japanese High Density Winds from MTSAT
<b>N</b>	
NAS	Network Attached Storage
NAT	Network Address Translation
NC	National Center
NCDC	National Climatic Data Center
NCEP	National Centers for Environmental Prediction
NCF	Network Control Facility
NCWF	National Convective Weather Forecast
NDFD	National Digital Forecast Database
NDM	National Data Sets Maintenance
NESDIS	National Environmental Satellite, Data, and Information Service
netCDF	network common data format
NFS	network file system
NGM	Nested Grid Model
NH	Northern Hemisphere
NIS	Network Information Services
NIST	National Institute of Standards and Technology
NLDN	National Lightning Detection Network
NMT	National Weather Service Modernization and Test Integration System (a place, like NCF)
NOAA	National Oceanic and Atmospheric Administration
NOAAPORT	A broadband communications system designed to distribute information products produced or gathered by NOAA organizations
NOC	Network Operations Center
NOGAPS	Navy Operational Global Atmospheric Prediction System
NOHRSC	National Operational Hydrologic Remote Sensing Center
NOMADS	NOAA Operational Model Archive and Distribution System
NRC	National Reconditioning Center
NRP	NOAAPORT Receive Processor
NRS	NOAAPORT Receive System
NSM	Netscreen Security Manager
NTP	Network Time Protocol
NUSM	NEXRAD Unit Status Message
NWR	NOAA Weather Radio
NWRE	NOAA Weather Radio Editor



NWRS	NOAA Weather Radio Service
NWRWAVES	NOAA Weather Radio With All-Hazards VTEC Enhanced Software
NWS	National Weather Service
NWSRFS	NWS River Forecast System
NWSTG	NWS Telecommunications Gateway
NWWS	NOAA Weather Wire Service

**O**

OAR	Oceanic and Atmospheric Research
OB	Operational Build
ODS	Online Dynamic Server
OH	Office of Hydrology
OHD	Office of Hydrologic Development
OM	Office of Meteorology
ORDA	Open Radar Data Acquisition
ORPG	Open Radar Product Generator
OS	operating system
OS	operational site
OSF	Open Software Foundation
OSFW	NEXRAD Operational Support Facility (WFO)
OT&E	operational testing and evaluation
OTR	one-time request
OUP	Official User Product
OVO	OpenView Operations (replaced IT/O)

**P**

PA	Project Authorization
PC	Personal Computer
PID	process identification
PIL	product inventory list
POES	Polar Orbiting Environmental Satellite
PPI	planned product improvement; plan position indicator
PPID	Parent Data Controller ID
ppm	pages per minute
PRR	Product Request Response
PSS	packet-switching service
PTL	Product List
PTM	point-to-multipoint
PTSU	Pacific Tsunami Warning Center

PTP	point-to-point
PUP	principal user processor
PV	PowerVault
PVC	permanent virtual circuit
PX	Linux Preprocessor
PYRO	Python Remote Objects
<b>Q</b>	
QC	quality control
QCMS	Quality Control and Monitoring System
QPE	Quantitative Precipitation Estimate
QPF	Quantitative Precipitation Forecast
QPID	Queue Processor Interface Daemon
QuikSCAT	NASA's Quick Scatterometer
<b>R</b>	
RAID	Redundant Array of Independent Disks
RAM	random access memory
RAMOS	Remote Automatic Meteorological Observing System
RAP	Rapid Refresh
RAX	RFC Archive Server
RCM	radar-coded message
RCM	Radar Configuration Manager
RCP	Rich Client Platform
RDA	radar data acquisition
RDBMS	relational database management system
REP	River Ensemble Processor
RHEL	Red Hat Enterprise Linux
RFC	River Forecast Center
RFC GW	RFC Gateway
RGG	Red Green Blue
RH	relative humidity
RHQ	Regional Headquarters
RMI	Remote Method Invocation
RISC	reduced instruction set computer (workstation)
RMR	radar multiple request
ROC	WSR-88D Radar Operations Center
ROSA	remote observing system automation
RP	REP CPU

RPG	radar product generator
RPS	routine product set
RRS	Radiosonde Replacement System
RTGSST	Real Time High Resolution Global Sea Surface Temperature grids

## S

SAFESEAS	System on AWIPS for Forecasting and Evaluation of Seas and Lakes
SAM	System Administration Manager
SBN	Satellite Broadcast Network
SBP	Satellite Broadcast Processor
SCAN	System for Convection Analysis and Nowcasting
SCD	Supplementary Climate Data
SCID	Storm Cell Identification Display
SCP	Satellite Cloud Product
SCSI	small computer system interface
SCTI	SCAN Convective Threat Index
SDK	Software Developers Kit
SDRAM	Synchronous Dynamic Random Access Memory
SDS	software disk striping; switched data service
SEC	Systems Engineering Center
SEDA	Serial Event Driven Architecture
SFMG	Spaceflight Meteorology Group's (SMG) WFO system identifier
SGS	Site Ground Station
SHEF	Standard Hydrometeorological Exchange Format
SMM	AWIPS System Manager's Manual
SLDFD	site-level data flow diagram
SNMP	Simple Network Management Protocol
SNOW	System for Nowcasting of Winter Weather
SOA	Service Oriented Architecture
SPG	Supplemental Product Generator
SPS	Special Weather Statement
SSH	secure shell
SSMI (/I)	Special Sensor Microwave Imager (both SSMI and SSM/I are used but SSM/I is correct)
SST	sea surface temperature
SST	Site Support Team
STD	season to date
STI	Storm Track Information
SVS	switched voice service
<b>SW</b>	<b>Sky Weather</b>

---

SW	spectrum width/software
SWP	Severe WX Problem
<b>T</b>	
TAF	Terminal Aerodrome Forecast (international code)
TB	terabyte
TC	temperatures in degrees Celsius
Tcl	tool command language
TCP	Transport Control Protocol
TDWR	Terminal Doppler Weather Radar
TF	temperature in degrees Fahrenheit
THP	Total Hourly Precipitation
TIU	terminal interface unit
Tk	tool kit
TMT	Tracking Meteogram Tool
TPG	Toy Parser Generator
TVS	Tornadic Vortex Signature
TWEB	Transcribed Weather Enroute Broadcast
<b>U</b>	
UAM	User Alert Message
UGC	universal geographic code
UI	User Interface
UID	user ID number
ULR	User Selectable Reflectivity
URI	Uniform Resource Identifier
URL	Universal Resource Locator
USP	User Select Precipitation
UTC	Universal Time Coordinated
UW	u-component of wind
<b>V</b>	
V	Velocity
VCP	Volume Coverage Pattern
VIL	Vertically Integrated Liquid
VIR	visible infrared
VRP	Voice-Ready Product
VSAT	Very Small Aperture Terminal

**W**

WAN	wide area network
WAX	WFO Archive Server
WBC	Watch By County
WCL	Watch County List
WCN	Weather Watch County Notification
WES	Weather Event Simulator
WES-2 Bridge	Weather Event Simulator-2 Bridge (provides training and simulation capabilities for the AWIPS II platform)
WFO	Weather Forecast Office
WIN32	Common 32-bit Microsoft Windows Platform
WMO	World Meteorological Organization (UN)
WSH	Weather Service Headquarters
WOU	Watch Outline Update Message
WSO	Weather Service Office
WSR	Weather Surveillance Radar
WSR-88D	WSR-1988 Doppler Weather Radar
WWV	time-signal broadcast call letters
WW3	WAVEWATCH III

**X, Y, Z**

XML	eXtensible Markup Language
YTD	Year to Date
YUM	Yellowdog Updater Modified

**Appendix AA**  
**Instructions to Ingest ARI for your Site**

This appendix describes the instructions for FFMP 20.45 work assignment installation.

### ***A1.0 Instructions to Ingest ARI for your Site***

ARI (average recurrence interval) grid files can now be used in FFMP. These are GIS-derived archival data that allow you to compare QPE against historic precipitation patterns. They are a static dataset showing precipitation probability for 1, 2, 5, 25, 50, 100, 200, 500, 1000 year periods.

NWS offices can download the raw ARI grids, which total around 700 MB, from the following link:

<http://flash.ou.edu/files/ari/>

This provides 6 zip files, one for each of the following durations: 30 minutes, and 1, 3, 6, 12, 24 hours. Each zip files has GRIB2 files for the following recurrence intervals: 1, 2, 5, 25, 50, 100, 200, 500, 1000 years.

You'll need to add "YEZZ88\_KWBZ" to the names of ALL of the files before you copy them into EDEX manual ingest.

**Note:** The following wgrib2 output is provided to help identify/confirm that it is the correct grid as this is not a baseline dataset.

The wgrib output shows this.

*wgrib2 -V 30m\_5yr.grib*

*•ERROR: local table = D is not allowed, set to 1 \*\*\**

*1:0:vt=2015020112:surface:anl:var discipline=1 center=161 local\_table=0 parmcat=0  
parm=194:*

*ndata=24500000:undef=0:mean=-444.885:min=-999:max=2308.95*

*grid\_template=0:winds(N/S):*

*lat-lon grid:(7000 x 3500) units 1e-06 input WE:NS output WE:SN res 48*

*lat 55.000000 to 20.000000 by 0.010000*

*lon 229.999999 to 299.999999 by 0.010000 #points=24500000*

### **Follow these instructions to ingest ARI for your site:**

**Note:** It is assumed that are available in your system in order to use this functionality. Since this is not baseline data, directions above should be followed to acquire the ARI data.

The BASE delivered FFMPSourceConfig.xml has the proper configuration necessary to ingest the data into FFMP. If you have customized a SITE level file already, merge the entries into

your file.

The following is the information on the new configuration:

- The tag is called `<sourceFamily>`. Here is an example.

```
<sourceFamily>ARIFFG</sourceFamily>
```

This sets ARIFFG as a source family. The way the coverages are created for FFMP makes it a one to one relationship for sourceBins to Source. Since ARI and RFCFFG use the same grid (coverage), this allows reuse of sourceBins rather than create new set for every single Source.

Only sources of `<sourceType>GUIDANCE</sourceType>` have this new tag.

Here are the instructions for upgrading an existing siteLevel FFMPSourceConfig.xml.

1. Stop ingestDat on all EDEX servers using the command:
 

```
service edex_camel stop ingestDat
```
2. Copy existing source file to FFMPSourceConfig.xml.old.
3. In an editor, open the new and old files.
4. In the new file, scroll all the way down to where the last source is.
5. Up to that point everything above there is just source related. That should all just be over written with the new version of the file.
6. The `<product primarySource="XXXXXXXX">` entries are what creates the Menu items and adds the sources that will be compared in the table display for FFMP. A site can plunk, their portions of the file from here down into the new file and all of the new ARI/MRMS sources would just be ignored in CAVE and never shown.
7. If a site wants the new sources added to existing products, merge them from BASE. Edit the qpf and guidance entries that need to be enabled or disabled.

Here is an example for guidance:

ON

```
<guidance>ARI30M1YR, ARI1H1YR, ARI3H1YR, ARI6H1YR, ARI12H1YR,
ARI24H1YR</guidance>
```



OFF

```
<!-- <guidance>ARI30M1YR, ARI1H1YR, ARI3H1YR, ARI6H1YR, ARI12H1YR,
ARI24H1YR</guidance> -->
```

Here is an example for a product:

Orig Product:

```
<product primarySource="DHR">
  <rate>DHR</rate>
  <qpe>DHR</qpe>
  <qpf>QPFSCAN</qpf>
  <qpf>PRTM</qpf>
  <qpf>BPRTM</qpf>
  <guidance>FFG0124hr, FFG0324hr, FFG0624hr</guidance>
  <virtual>VGBDHR</virtual>
</product>
```

New Product:

```
<product primarySource="DHR">
  <rate>DHR</rate>
  <qpe>DHR</qpe>
  <qpf>QPFSCAN</qpf>
  <qpf>PRTM</qpf>
  <qpf>BPRTM</qpf>
  <qpf>HRRRQPF</qpf>
  <qpf>MRMSQPF</qpf>
  <!-- <guidance>FFG0124hr, FFG0324hr, FFG0624hr</guidance> -->
  <guidance>ARI30M1YR, ARI1H1YR, ARI3H1YR, ARI6H1YR, ARI12H1YR,
ARI24H1YR</guidance>
  <guidance>ARI30M2YR, ARI1H2YR, ARI3H2YR, ARI6H2YR, ARI12H2YR,
ARI24H2YR</guidance>
  <guidance>ARI30M5YR, ARI1H5YR, ARI3H5YR, ARI6H5YR, ARI12H5YR,
ARI24H5YR</guidance>
  <guidance>ARI30M10YR, ARI1H10YR, ARI3H10YR, ARI6H10YR, ARI12H10YR,
ARI24H10YR</guidance>
  <guidance>ARI30M25YR, ARI1H25YR, ARI3H25YR, ARI6H25YR, ARI12H25YR,
ARI24H25YR</guidance>
  <guidance>ARI30M50YR, ARI1H50YR, ARI3H50YR, ARI6H50YR, ARI12H50YR,
ARI24H50YR</guidance>
  <guidance>ARI30M100YR, ARI1H100YR, ARI3H100YR, ARI6H100YR, ARI12H100YR,
ARI24H100YR</guidance>
  <guidance>ARI30M200YR, ARI1H200YR, ARI3H200YR, ARI6H200YR, ARI12H200YR,
ARI24H200YR</guidance>
  <guidance>ARI30M500YR, ARI1H500YR, ARI3H500YR, ARI6H500YR, ARI12H500YR,
ARI24H500YR</guidance>
  <guidance>ARI30M1000YR, ARI1H1000YR, ARI3H1000YR, ARI6H1000YR, ARI12H1000YR,
ARI24H1000YR</guidance>
  <virtual>VGBDHR</virtual>
</product>
```

You can simply comment out the lines which are not desired. This example commented out RFCFFG and will now only display ARIFFG sources in the menus and tables for this product.

- There is one caveat regarding the MRMS dataset. If you wish to use the `<product primarySource="MRMS">` and have it ingest data and display all the menus, you will

have to copy it's product tag into the FFMPSourceConfig.xml and also add a product tag to the FFMPRunConfig.xml as well.

For the FFMPSourceConfig.xml part of this. Just retain this from the new FFMPSourceConfig.xml

```
<product primarySource="MRMS">
  <rate>MRMS</rate>
  <qpe>MRMS</qpe>
  <qpf>QPFSCAN</qpf>
  <qpf>BPRTM</qpf>
  <qpf>PRTM</qpf>
  <qpf>MRMSQPF</qpf>
  <qpf>HRRRQPF</qpf>
  <guidance>FFG0124hr, FFG0324hr, FFG0624hr</guidance>
  <guidance>ARI30M1YR, ARI1H1YR, ARI3H1YR, ARI6H1YR, ARI12H1YR, ARI24H1YR</guidance>
  <guidance>ARI30M2YR, ARI1H2YR, ARI3H2YR, ARI6H2YR, ARI12H2YR, ARI24H2YR</guidance>
  <guidance>ARI30M5YR, ARI1H5YR, ARI3H5YR, ARI6H5YR, ARI12H5YR, ARI24H5YR</guidance>
  <guidance>ARI30M10YR, ARI1H10YR, ARI3H10YR, ARI6H10YR, ARI12H10YR,
ARI24H10YR</guidance>
  <guidance>ARI30M25YR, ARI1H25YR, ARI3H25YR, ARI6H25YR, ARI12H25YR,
ARI24H25YR</guidance>
  <guidance>ARI30M50YR, ARI1H50YR, ARI3H50YR, ARI6H50YR, ARI12H50YR,
ARI24H50YR</guidance>
  <guidance>ARI30M100YR, ARI1H100YR, ARI3H100YR, ARI6H100YR, ARI12H100YR,
ARI24H100YR</guidance>
  <guidance>ARI30M200YR, ARI1H200YR, ARI3H200YR, ARI6H200YR, ARI12H200YR,
ARI24H200YR</guidance>
  <guidance>ARI30M500YR, ARI1H500YR, ARI3H500YR, ARI6H500YR, ARI12H500YR,
ARI24H500YR</guidance>
  <guidance>ARI30M1000YR, ARI1H1000YR, ARI3H1000YR, ARI6H1000YR, ARI12H1000YR,
ARI24H1000YR</guidance>
  <virtual>MRMSVGB</virtual>
</product>
```

Then you can edit the qpf and guidance entries however you wish.

For the part you have to do to the FFMPRunConfig.xml.

Open the file and under this comment in the FFMPRunConfig.xml...

```
<!-- Product definitions to be run against -->
```

add this...

```
<product name="MRMS" key="mrms"/>
```

9. On all EDEX servers, restart ingestDat and monitor the logs until FFMP has finished processing. This process can take up to 30 minutes to complete.

**Appendix B**  
**Decoding and Storage Data Flow Exhibits**

## Appendix B. Decoding and Storage Data Flow Exhibits

### Table of Contents

		<i>Page</i>
B.1	Introduction.....	1
B.2	AWIPS Data Flow Diagrams.....	1

### List of Exhibits

Exhibit B.2-1.	AWIPS II Servers Overview.....	4
Exhibit B.2-2.	Overall AWIPS II Servers Processes.....	5
Exhibit B.2-3.	SBN Data Flow.....	6
Exhibit B.2-4.	Radar Data Flow.....	7
Exhibit B.2-5.	Acquire and Ingest of Satellite Products.....	8
Exhibit B.2-6.	Acquire and Ingest of NWSTG Products.....	9
Exhibit B.2-7.	Acquire and Ingest of Radar Products.....	10
Exhibit B.2-8.	Acquire and Ingest of Asynchronous Products.....	11
Exhibit B.2-9.	Acquire and Ingest of Lightning Products.....	12
Exhibit B.2-10.	Acquire and Ingest of METAR Products.....	13
Exhibit B.2-11.	Acquire and Ingest of MOS Products.....	14
Exhibit B.2-12.	Acquire and Ingest of BUFR Products.....	15
Exhibit B.2-13.	Acquire and Ingest of Synoptic Products.....	16
Exhibit B.2-14.	Acquire and Ingest of SSM/I Products.....	17
Exhibit B.2-15.	Generic Acquire and Decode LDAD Product (Page 1 of 2).....	18
Exhibit B.2-15.	Generic Acquire and Decode LDAD Product (Page 2 of 2).....	19
Exhibit B.2-16.	Acquire LARC/Handar 555 Data (for LDAD).....	20
Exhibit B.2-17.	Decode LARC/Handar 555 Data (for LDAD) (Page 1 of 2).....	21
Exhibit B.2-17.	Decode LARC/Handar 555 Data (for LDAD) (Page 2 of 2).....	22
Exhibit B.2-18.	Acquire Campbell Data (for LDAD).....	23
Exhibit B.2-19.	Decode Campbell Data (for LDAD) (Page 1 of 2).....	24
Exhibit B.2-19.	Decode Campbell Data (for LDAD) (Page 2 of 2).....	25
Exhibit B.2-20.	Acquire Sutron Data (for LDAD).....	26
Exhibit B.2-21.	Decode Sutron Data (for LDAD) (Page 1 of 2).....	27
Exhibit B.2-21.	Decode Sutron Data (for LDAD) (Page 2 of 2).....	28
Exhibit B.2-22.	Acquire and Decode Comma Separated Variable Mesonet Data (for LDAD) (Page 1 of 2).....	29
Exhibit B.2-22.	Acquire and Decode Comma Separated Variable Mesonet Data (for LDAD)	

(Page 2 of 2)..... 30

Exhibit B.2-23. Acquire and Process ASOS/MicroART Data (for LDAD) (Page 1 of 2)..... 31

Exhibit B.2-23. Acquire and Process ASOS/MicroART Data (for LDAD) (Page 2 of 2)..... 32

Exhibit B.2-24. Decode Alaska Profiler Data..... 33

Exhibit B.2-25. Acquire and Process RRS Data (for LDAD) (Page 1 of 2)..... 34

Exhibit B.2-25. Acquire and Process RRS Data (for LDAD) (Page 2 of 2)..... 35

Exhibit B.2-26. Climatological Reports Formatter for NWR and NWWS (Daily)..... 36

Exhibit B.2-27. Climatological Reports Formatter for NWR and NWWS  
(Monthly/Seasonal/Annual)..... 37

Exhibit B.2-28. Record Climate Data Flow..... 38

Exhibit B.2-29. Hourly Weather Roundup Formatter for NOAA Weather Wire Service..... 39

Exhibit B.2-30. Hourly Weather Roundup Formatter for NOAA Weather Radio..... 40

### **List of Tables**

Table B.2-1. AWIPS Data Flow Diagrams..... 2

Table B.2-2. AWIPS Data Flow Diagrams by Location ..... 3

## ***B.1 Introduction***

This section is composed of a series of exhibits that depict a high-level process and data flow from ingest through the routers to the data controllers and to the appropriate decoder. Graphic conventions used in the exhibits are as follows:

- Processes are shown in boxes.
- Servers are shown in shadowed boxes and are labeled as:
  - “CP” for communications processor;
  - “LS” for the LDAD Server;
  - “DX1” for Linux Data Server 1;
  - “DX2” for Linux Data Server 2;
  - “DX3” for Linux Data Server 3;
  - “DX4” for Linux Data Server 4;
  - “PX1” for Linux Preprocessor 1;
  - “PX2” for Linux Preprocessor 2; or
  - “WAX” for WFO Archive Server and RAX for RFC Archive Server.
- The arrows depict primary data flow.

Log files are depicted on the server where the logging process resides. Generated data files and accessed configuration files are all depicted. All files are shown with a full relative path designation.

## ***B.2 AWIPS Data Flow Diagrams***

All of the exhibits included in Appendix B also appear in the body of the System Manager’s Manual. Table B.2-1 cross-references the data flow diagrams in this appendix to their locations in the body of the document.

**Table B.2-1. AWIPS Data Flow Diagrams**

<b>Appendix B Exhibit No.</b>	<b>Title</b>	<b>Chapter Exhibit No.</b>
B.2-1	AWIPS II Servers Overview	2.7-3
B.2-2	Overall AWIPS II Server Processes	2.7-2
B.2-3	LDM Data Flow	4.4-1
B.2-4	Radar Data Flow	4.4-2
B.2-5	Acquire and Ingest of Satellite Products	5.2.1-1
B.2-6	Acquire and Ingest of NWSTG Products	6.3.3-1
B.2-7	Acquire and Ingest of Radar Products	7.2.1-1
B.2-8	Acquire and Ingest of Asynchronous Products	10.2-1
B.2-9	Acquire and Ingest of Lightning Products	6.4-1
B.2-10	Acquire and Ingest of METAR Products	6.5-1
B.2-11	Acquire and Ingest of MOS Products	6.6-1
B.2-12	Acquire and Ingest of BUFR Products	6.7-1
B.2-13	Acquire and Ingest of Synoptic Products	6.8-1
B.2-14	Acquire and Ingest of SSM/I Products	6.9-1
B.2-15	Generic Acquire and Decode LDAD Product	8.3.1-1
B.2-16	Acquire LARC/Handar 555 Data (for LDAD)	8.7-1
B.2-17	Decode LARC/Handar 555 Data (for LDAD)	8.8-1
B.2-18	Acquire Campbell Data (for LDAD)	8.9-1
B.2-19	Decode Campbell Data (for LDAD)	8.10-1
B.2-20	Acquire Sutron Data (for LDAD)	8.11-1
B.2-21	Decode Sutron Data (for LDAD)	8.12-1
B.2-22	Acquire and Decode Comma Separated Variable Mesonet Data (for LDAD)	8.13-1
B.2-23	Acquire and Process ASOS/MicroART Data (for LDAD)	8.14-1
B.2-24	Decode Alaska Profiler Data	8.16-1
B.2-25	Acquire and Process RRS Data (for LDAD)	8.17-1
B.2-26	Climatological Reports Formatter for NWR and NWWS (Daily)	9.1.3-1
B.2-27	Climatological Reports Formatter for NWR and NWWS (Monthly/Seasonal/Annual)	9.1.3-2
B.2-28	Record Climate Data Flow	9.2.2-1
B.2-29	Hourly Weather Roundup Formatter for NOAA Weather Wire Service	9.3.2-1
B.2-30	Hourly Weather Roundup Formatter for NOAA Weather Radio	9.4.2-1

Table B.2-2 provides an inverse mapping to Table B.2-1, listing the data flow diagrams by their locations in the body of the System Manager's Manual and cross-referencing them to their locations in Appendix B.

**Table B.2-2. AWIPS Data Flow Diagrams by Location**

Chapter Exhibit No.	Title	Appendix B Exhibit No.
2.7-3	AWIPS II Servers Overview	B.2-1
2.7-2	Overall AWIPS II Server Processes	B.2-2
4.4-1	LDM Data Flow	B.2-3
4.4-2	Radar Data Flow	B.2-4
5.2.1-1	Acquire and Ingest of Satellite Products	B.2-5
6.3.3-1	Acquire and Ingest of NWSTG Products	B.2-6
7.2.1-1	Acquire and Ingest of Radar Products	B.2-7
10.2-1	Acquire and Ingest of Asynchronous Products	B.2-8
6.4-1	Acquire and Ingest of Lightning Products	B.2-9
6.5-1	Acquire and Ingest of METAR Products	B.2-10
6.6-1	Acquire and Ingest of MOS Products	B.2-11
6.7-1	Acquire and Ingest of BUFR Products	B.2-12
6.8-1	Acquire and Ingest of Synoptic Products	B.2-13
6.9-1	Acquire and Ingest of SSM/I Products	B.2-14
8.3.1-1	Generic Acquire and Decode LDAD Product	B.2-15
8.7-1	Acquire LARC/Handar 555 Data (for LDAD)	B.2-16
8.8-1	Decode LARC/Handar 555 Data (for LDAD)	B.2-17
8.9-1	Acquire Campbell Data (for LDAD)	B.2-18
8.10-1	Decode Campbell Data (for LDAD)	B.2-19
8.11-1	Acquire Sutron Data (for LDAD)	B.2-20
8.12-1	Decode Sutron Data (for LDAD)	B.2-21
8.13-1	Acquire and Decode Comma Separated Variable Mesonet Data (for LDAD)	B.2-22
8.14-1	Acquire and Process ASOS/MicroART Data (for LDAD)	B.2-23
8.16-1	Decode Alaska Profiler Data	B.2-24
8.17-1	Acquire and Process RRS Data (for LDAD)	B.2-25
9.1.3-1	Climatological Reports Formatter for NWR and NWWS (Daily)	B.2-26
9.1.3-2	Climatological Reports Formatter for NWR and NWWS (Monthly/Seasonal/Annual)	B.2-27
9.2.2-1	Record Climate Data Flow	B.2-28
9.3.2-1	Hourly Weather Roundup Formatter for NOAA Weather Wire Service	B.2-29
9.4.2-1	Hourly Weather Roundup Formatter for NOAA Weather Radio	B.2-30



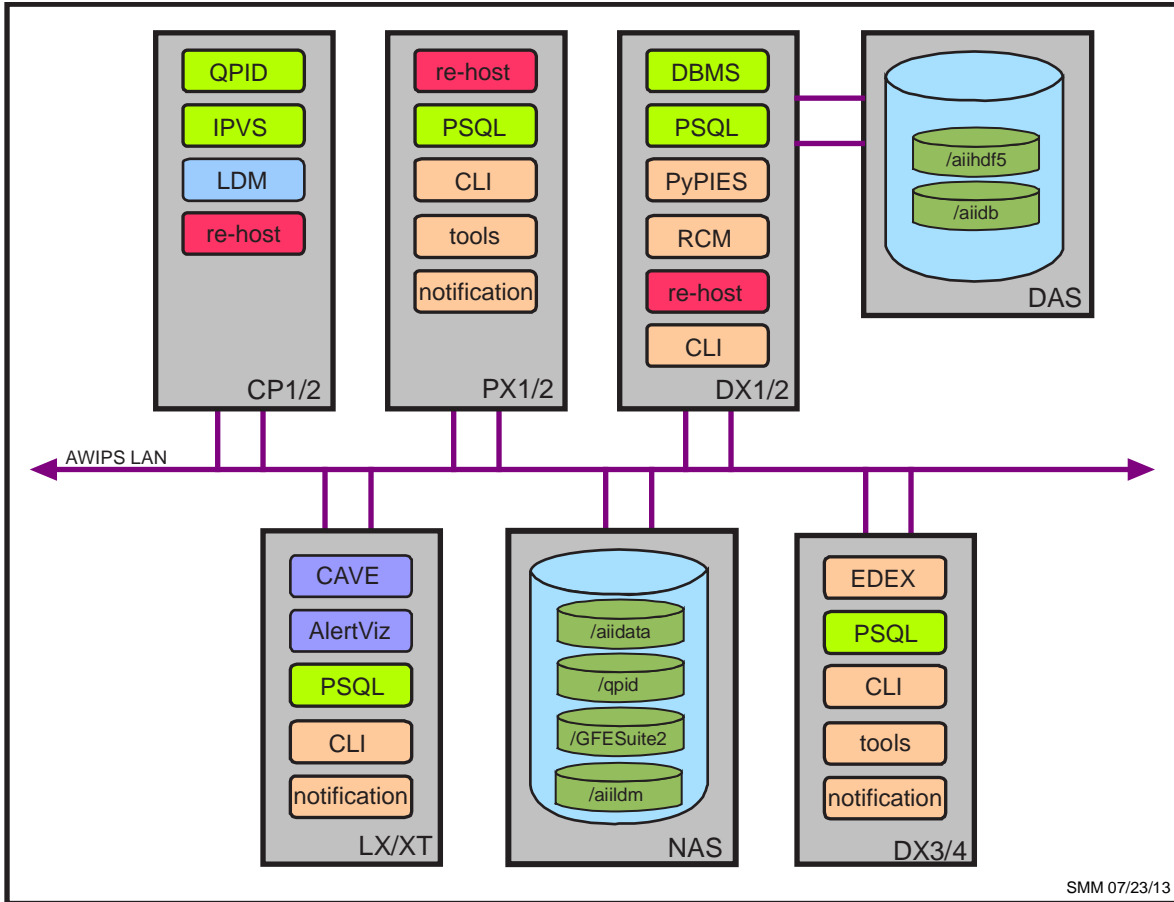

Exhibit B.2-1. AWIPS II Servers Overview

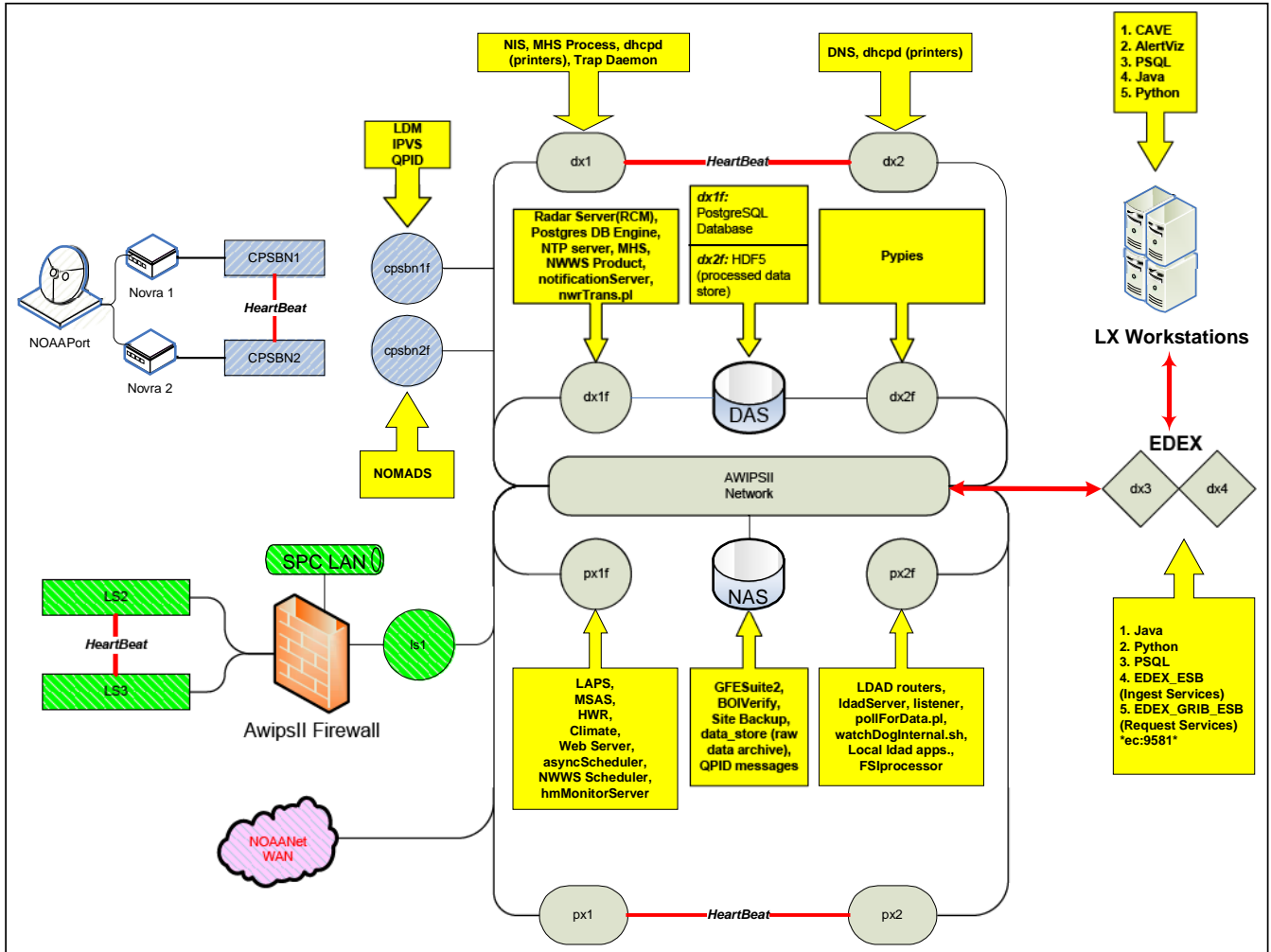
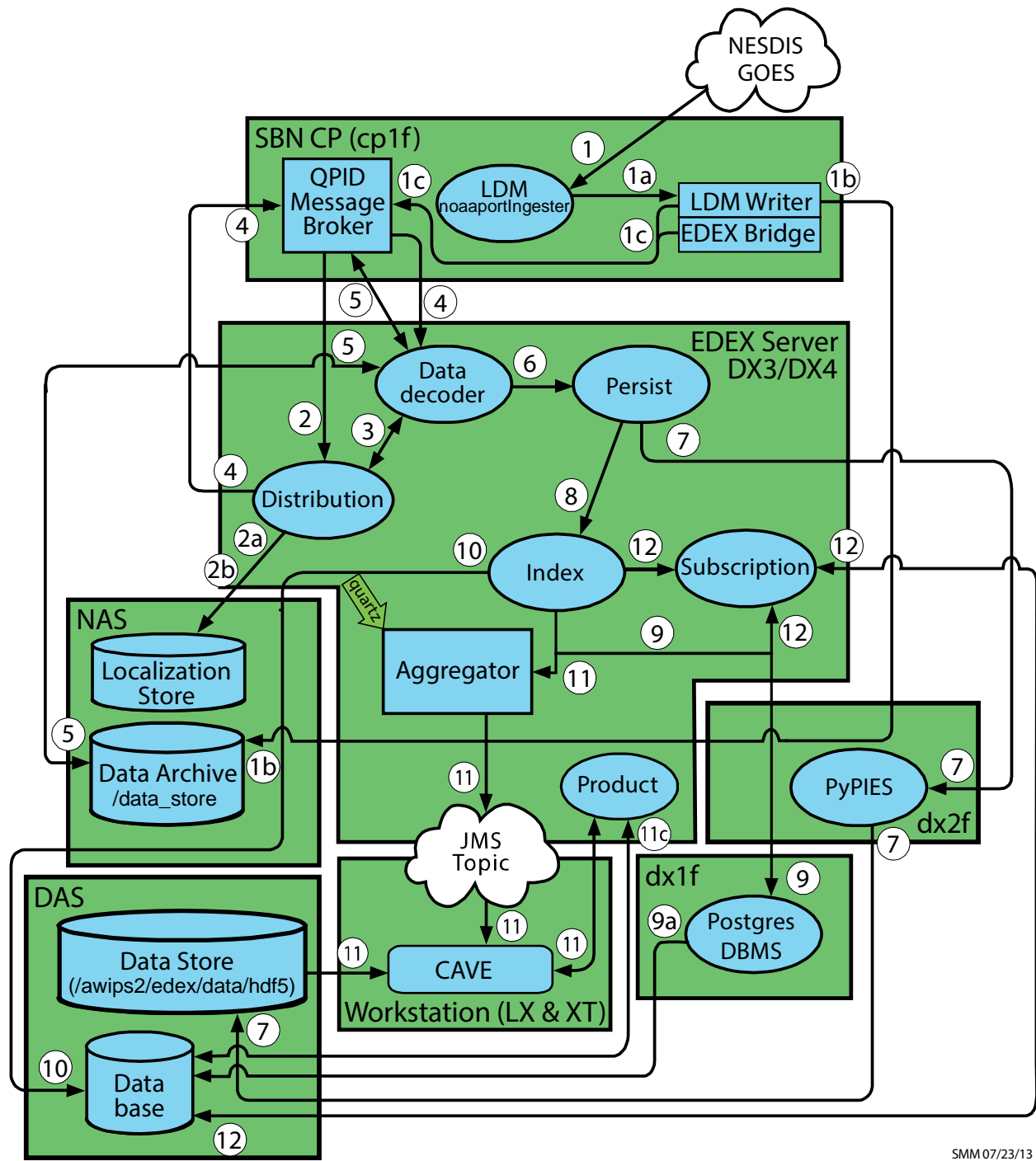

Exhibit B.2-2. Overall AWIPS II Servers Processes



SMM 07/23/13

Exhibit B.2-3. SBN Data Flow



Config Files:

pqaact.conf  
ldmd.conf

pqaact.conf  
ldmd.conf

/awips2/edex/data/utility/  
edex\_static/base/  
distribution

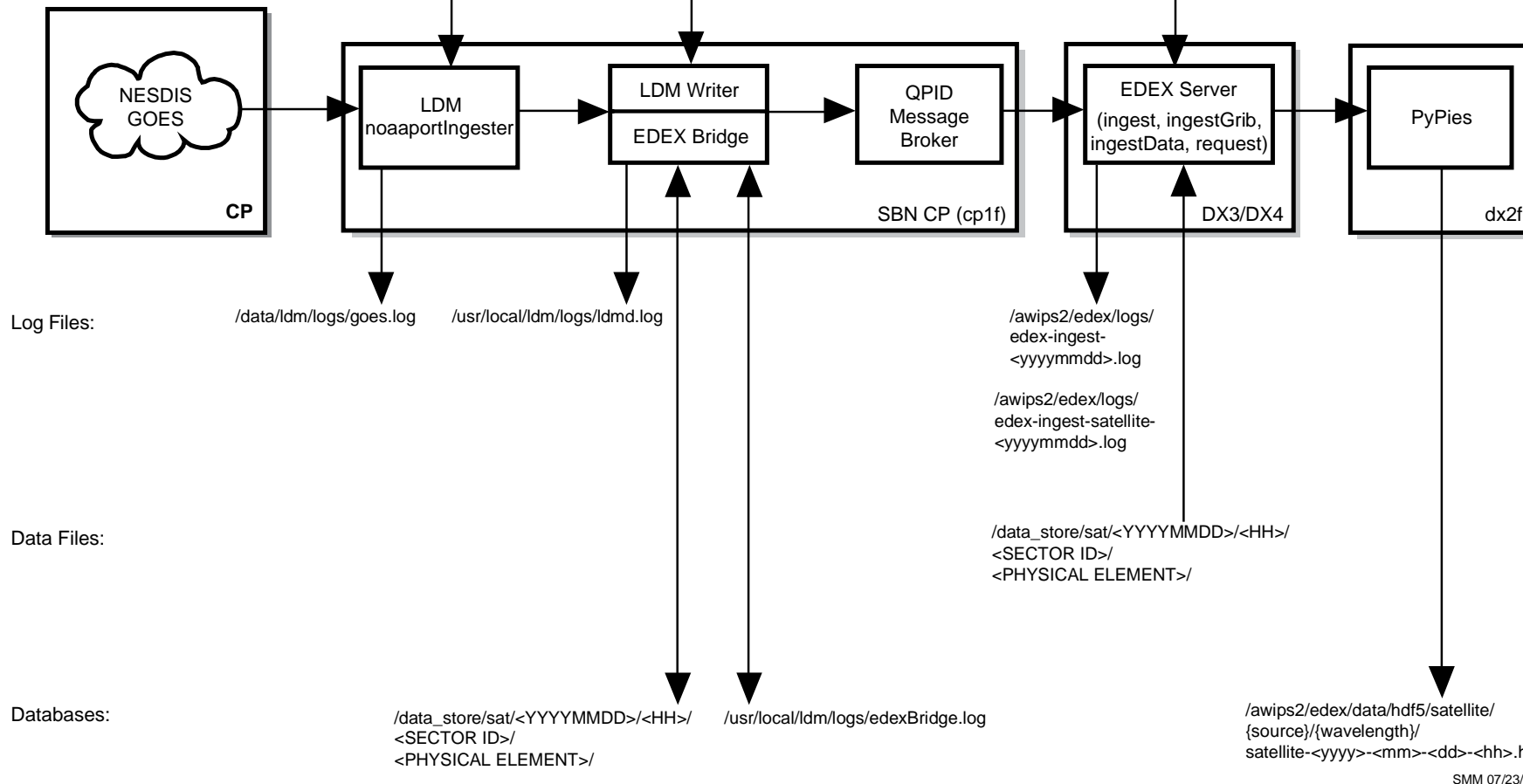

SMM 07/23/13

**Exhibit B.2-5. Acquire and Ingest of Satellite Products**

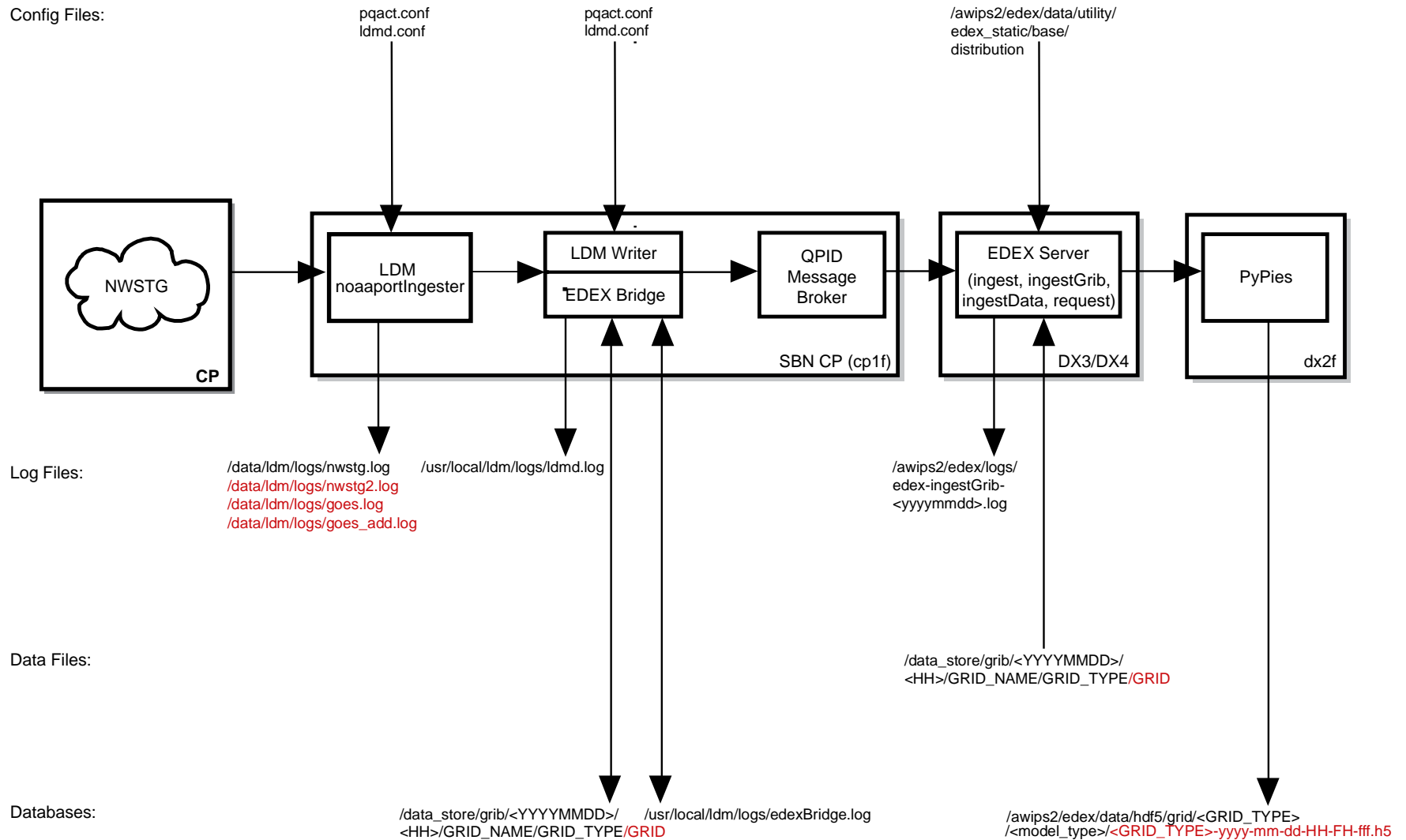

Exhibit B.2-6. Acquire and Ingest of NWSTG Products

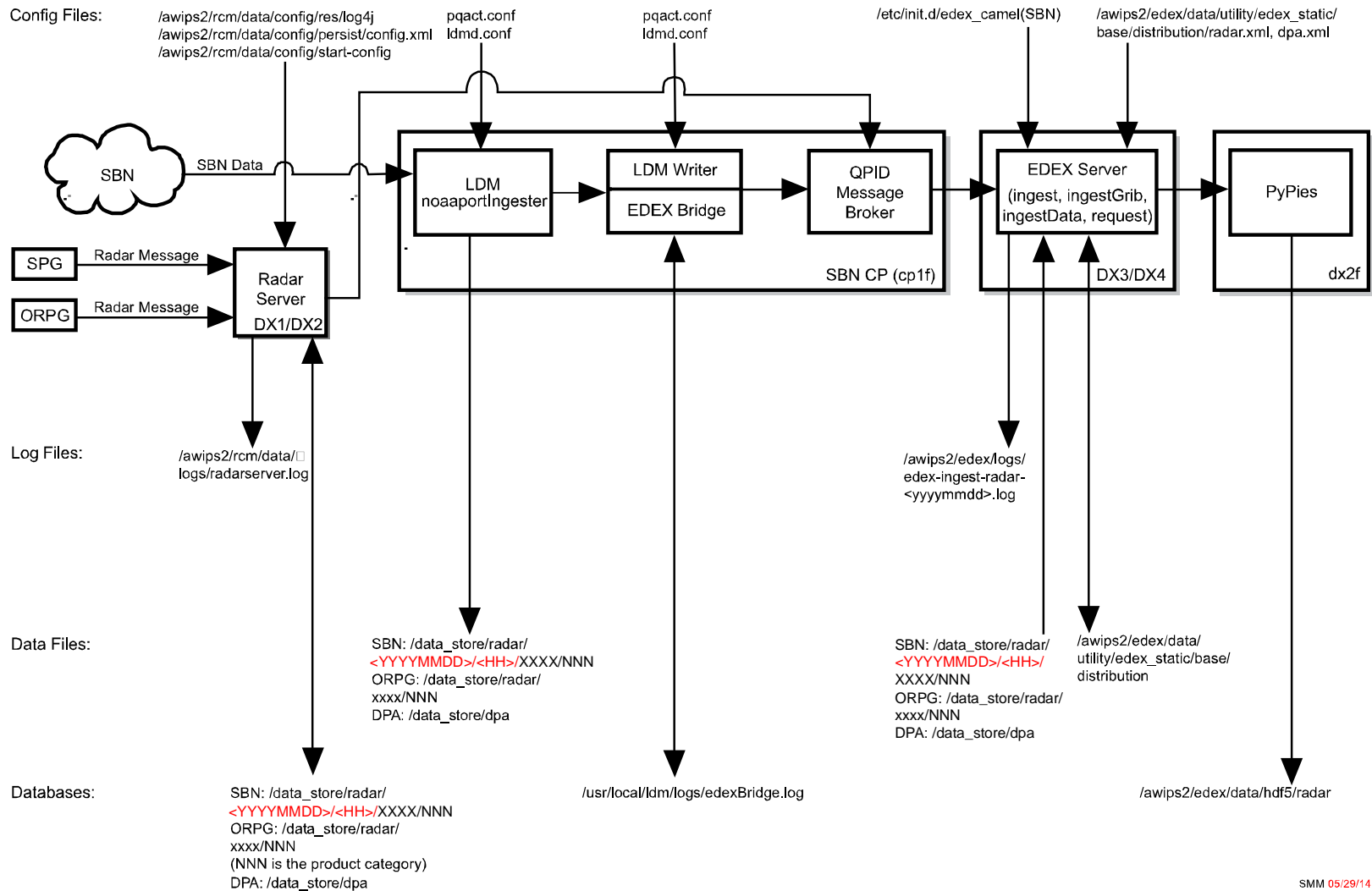
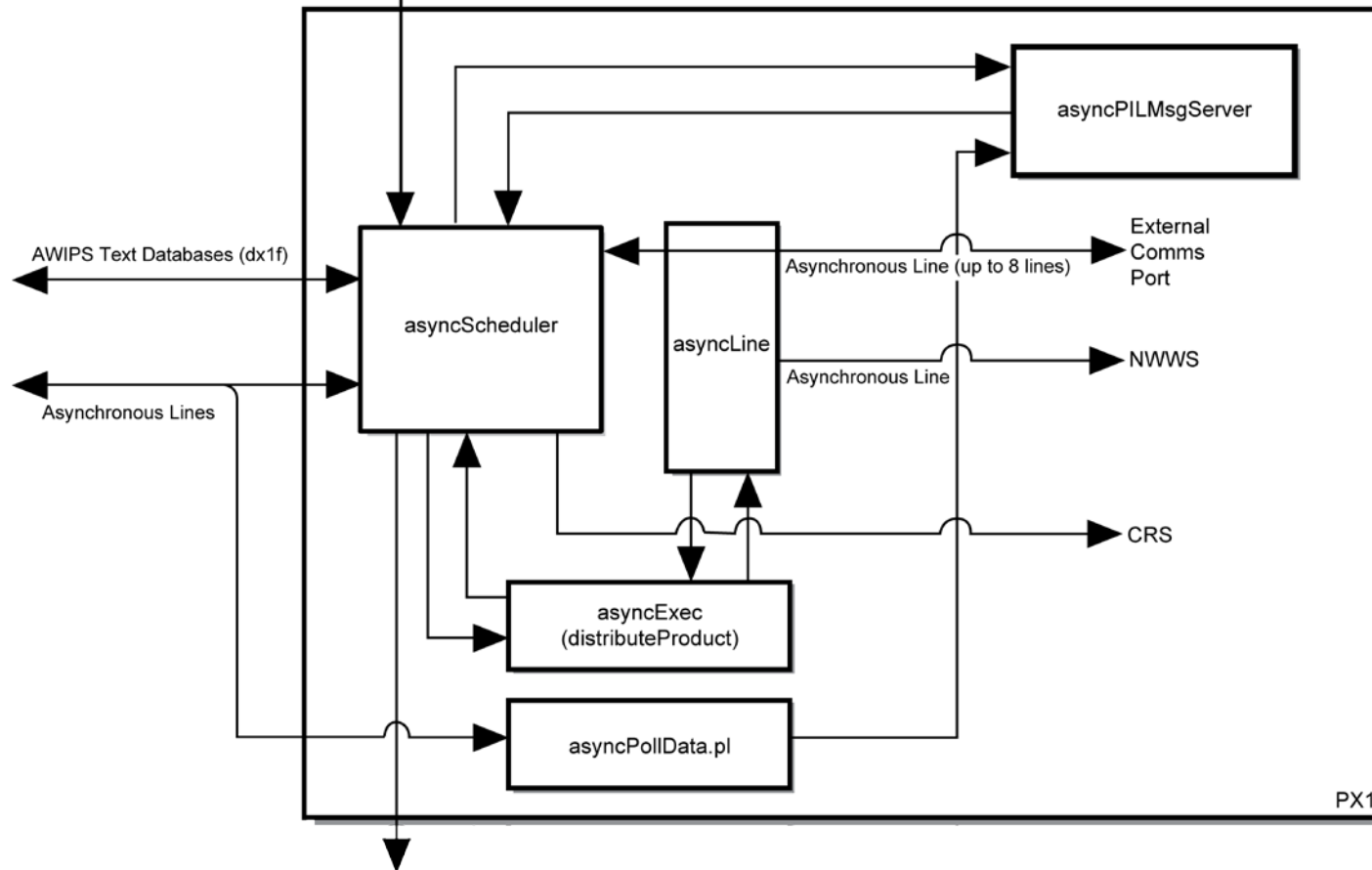

Exhibit B.2-7. Acquire and Ingest of Radar Products

Config Files:

\$FXA\_DATA/workFile/asyncProdScheduler/aps\_line.tbl  
 \$FXA\_DATA/workFiles/asyncProdScheduler/aps\_pil.tbl  
 \$FXA\_DATA/workFiles/asyncProdScheduler/aps\_route.tbl



Log Files:

\$LOG\_DIR/<yyyymmdd>/asyncScheduler<logid>

Data Files:

Databases:

SMM 01/21/2012

**Exhibit B.2-8. Acquire and Ingest of Asynchronous Products**



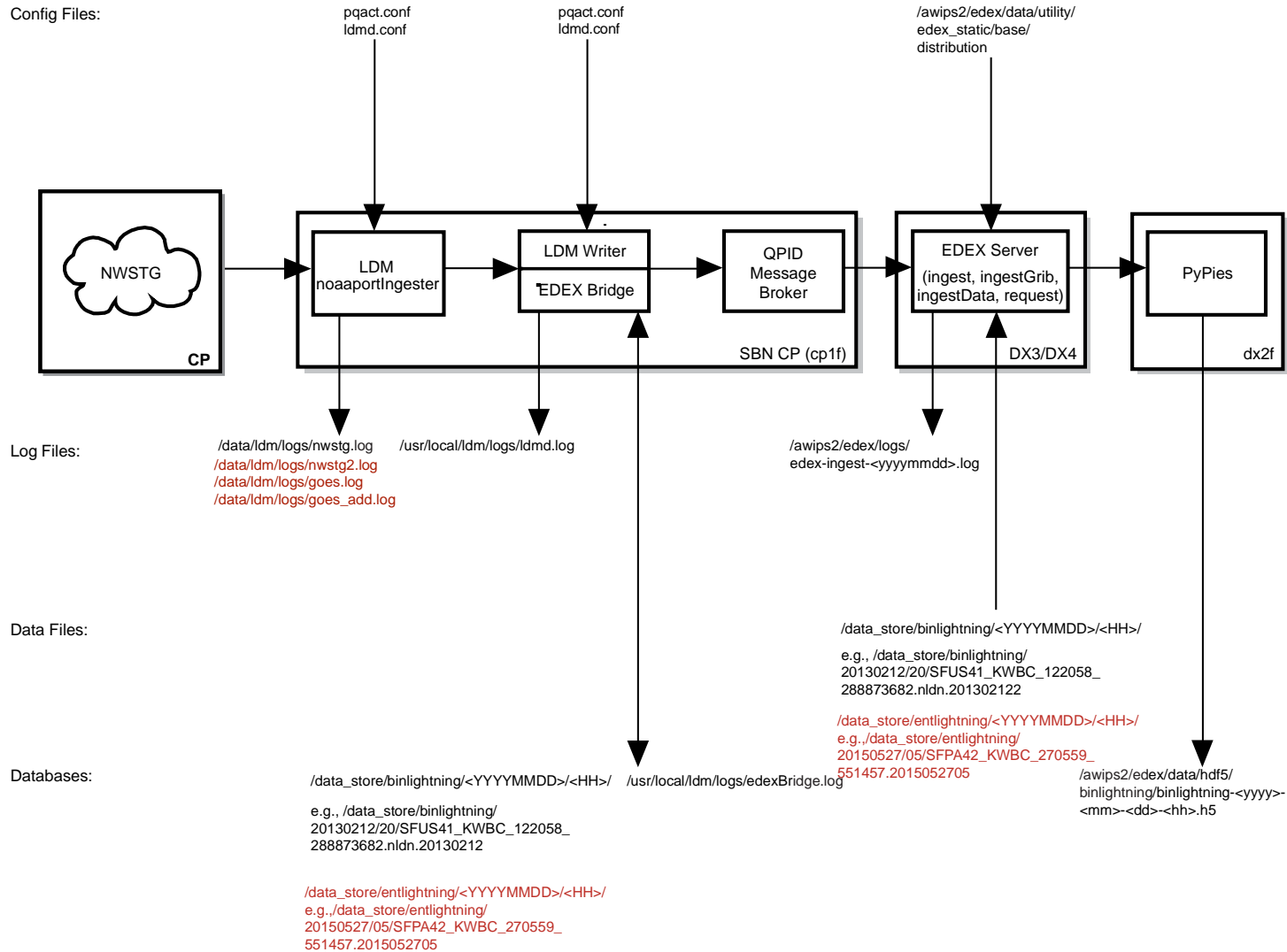

**Exhibit B.2-9. Acquire and Ingest of Lightning Products**

Config Files:

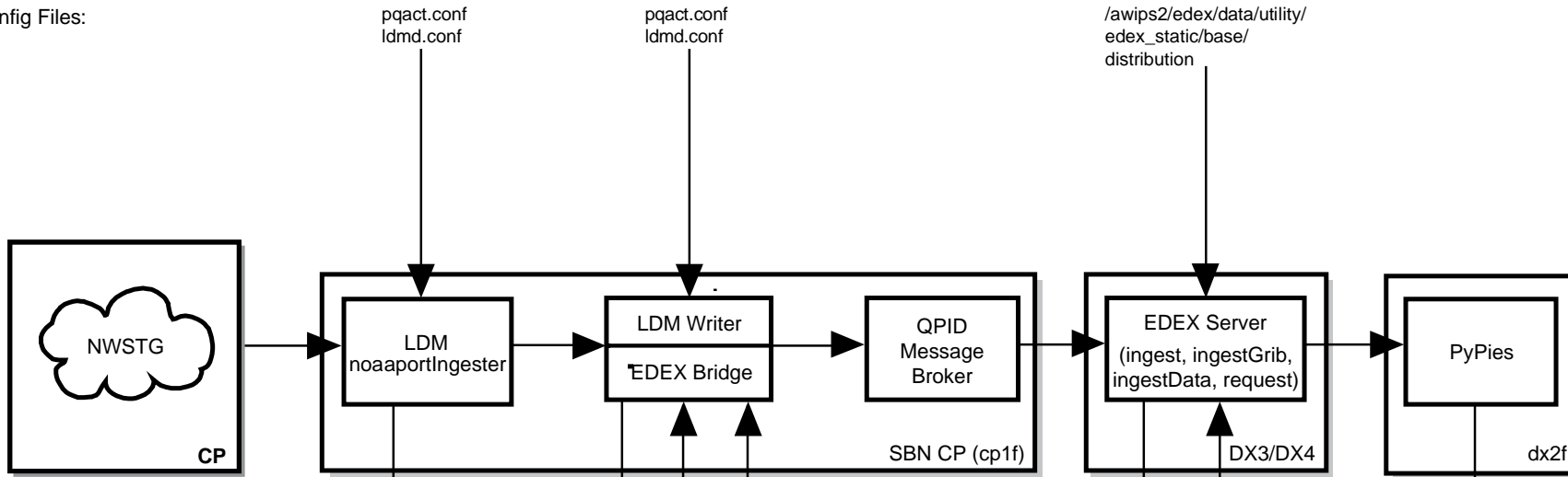

Log Files:

/data/ldm/logs/nwstg.log /usr/local/ldm/logs/ldmd.log  
 /data/ldm/logs/nwstg2.log  
 /data/ldm/logs/goes.log  
 /data/ldm/logs/goes\_add.log

/awips2/edex/logs/  
 edex-ingest-*<yyyymmdd>*.log

Data Files:

/data\_store/metar/*<YYYYMMDD>*/*<HH>*

Databases:

/data\_store/metar/*<YYYYMMDD>*/*<HH>* /usr/local/ldm/logs/edexBridge.log

/awips2/edex/data/hdf5/  
 metar/metar-yy-mm-dd-hh.h5

**Exhibit B.2-10. Acquire and Ingest of METAR Products**

Config Files:

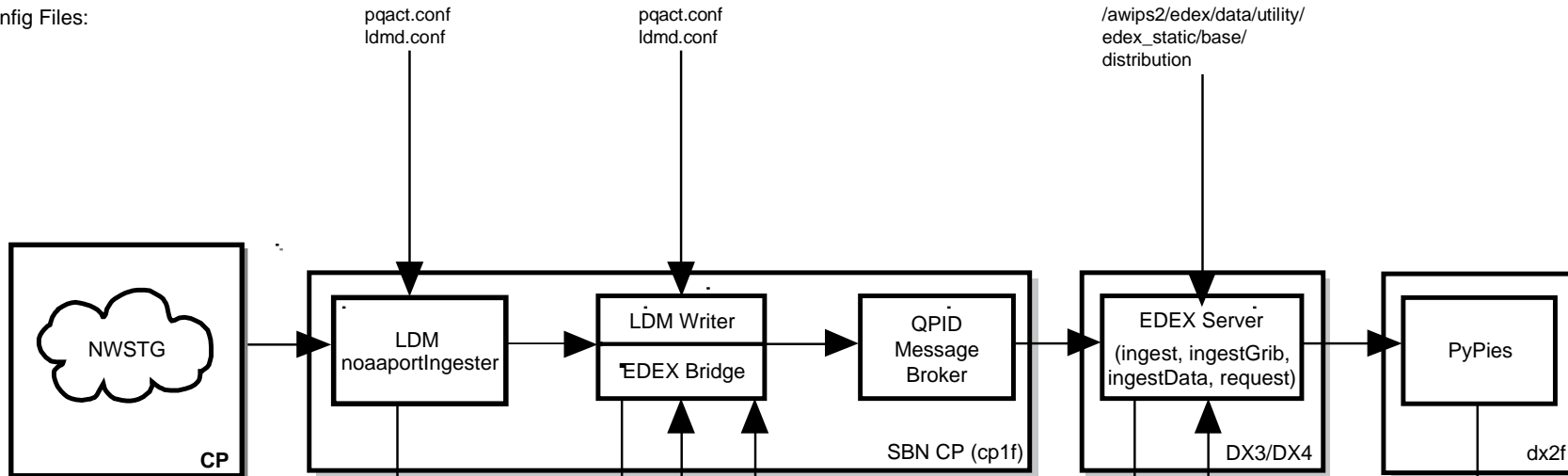

Log Files:

/data/ldm/logs/nwstg.log /usr/local/ldm/logs/ldmd.log  
 /data/ldm/logs/nwstg2.log  
 /data/ldm/logs/goes.log  
 /data/ldm/logs/goes\_add.log

/awips2/edex/logs/  
 edex-ingest-  
 <yyyymmdd>.log

Data Files:

/data\_store/bufrmos/  
 <YYYYMMDD>/<00-23>/

Databases:

/data\_store/bufrmos/  
 <YYYYMMDD>/<00-23>/

/usr/local/ldm/logs/edexBridge.log

/awips2/edex/data/hdf5/  
 bufrmos<model>/bufrmos-<model>-  
 <yyyy>-<mm>-<dd>-<hh>.h5

**Exhibit B.2-11. Acquire and Ingest of MOS Products**

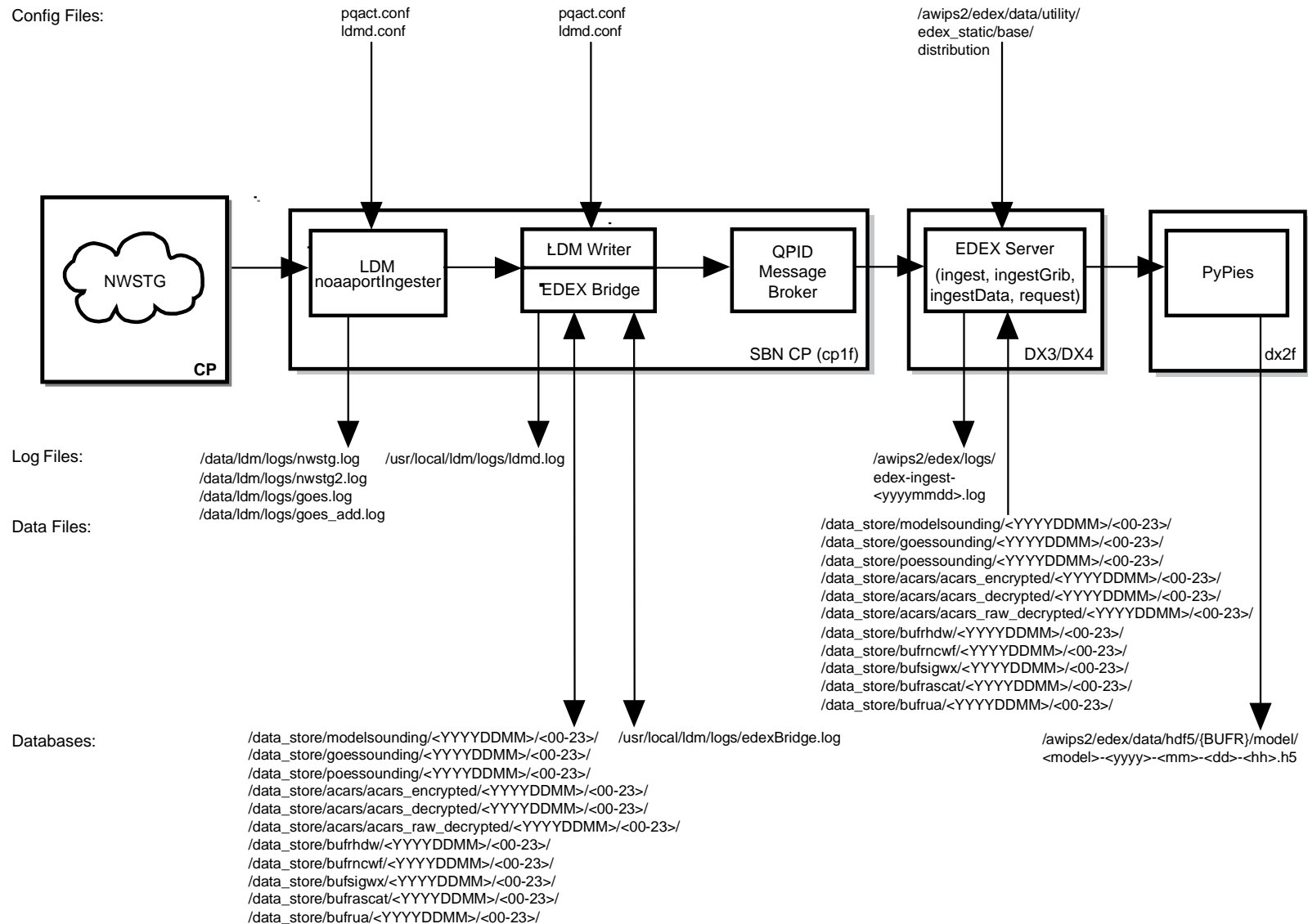
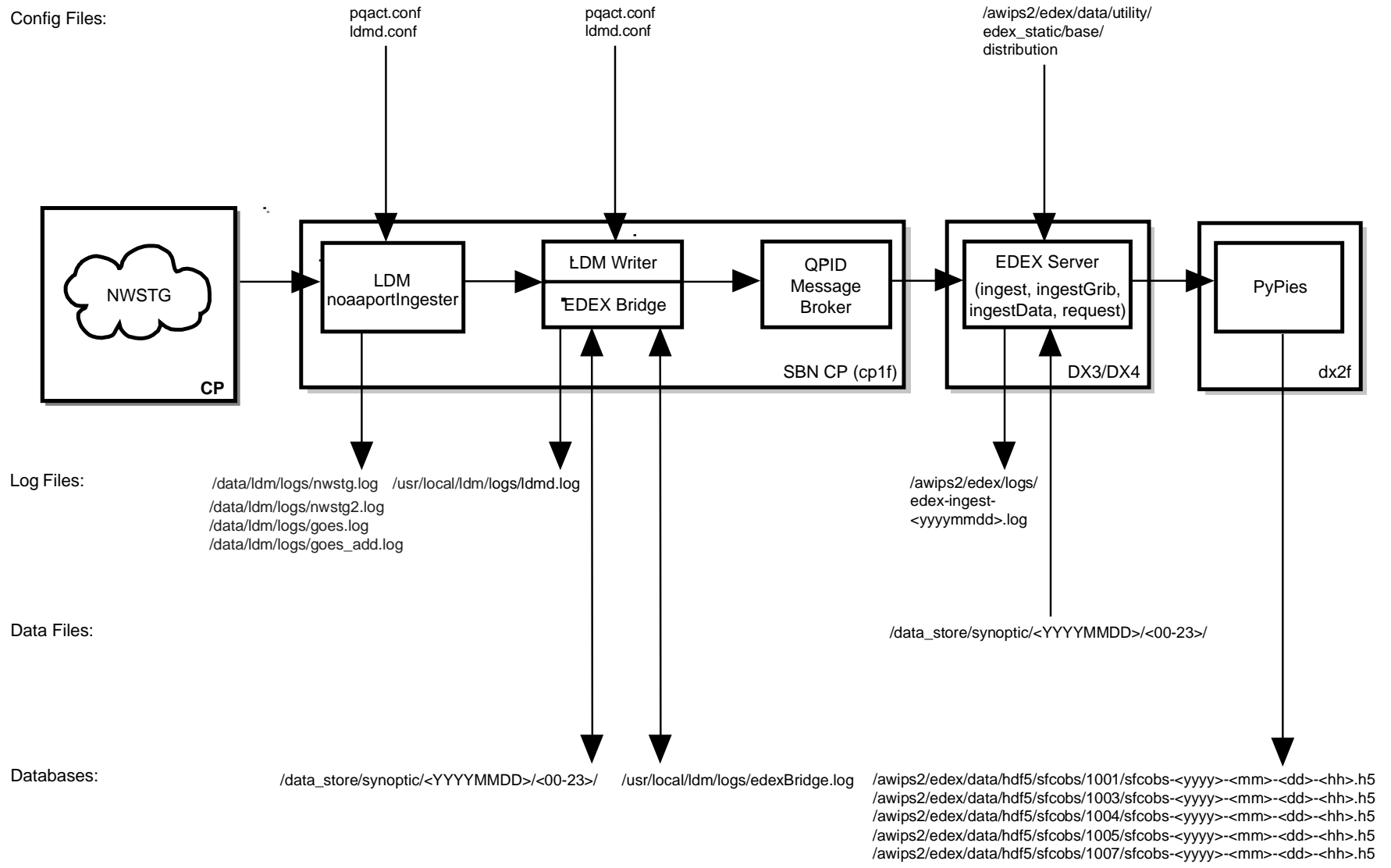
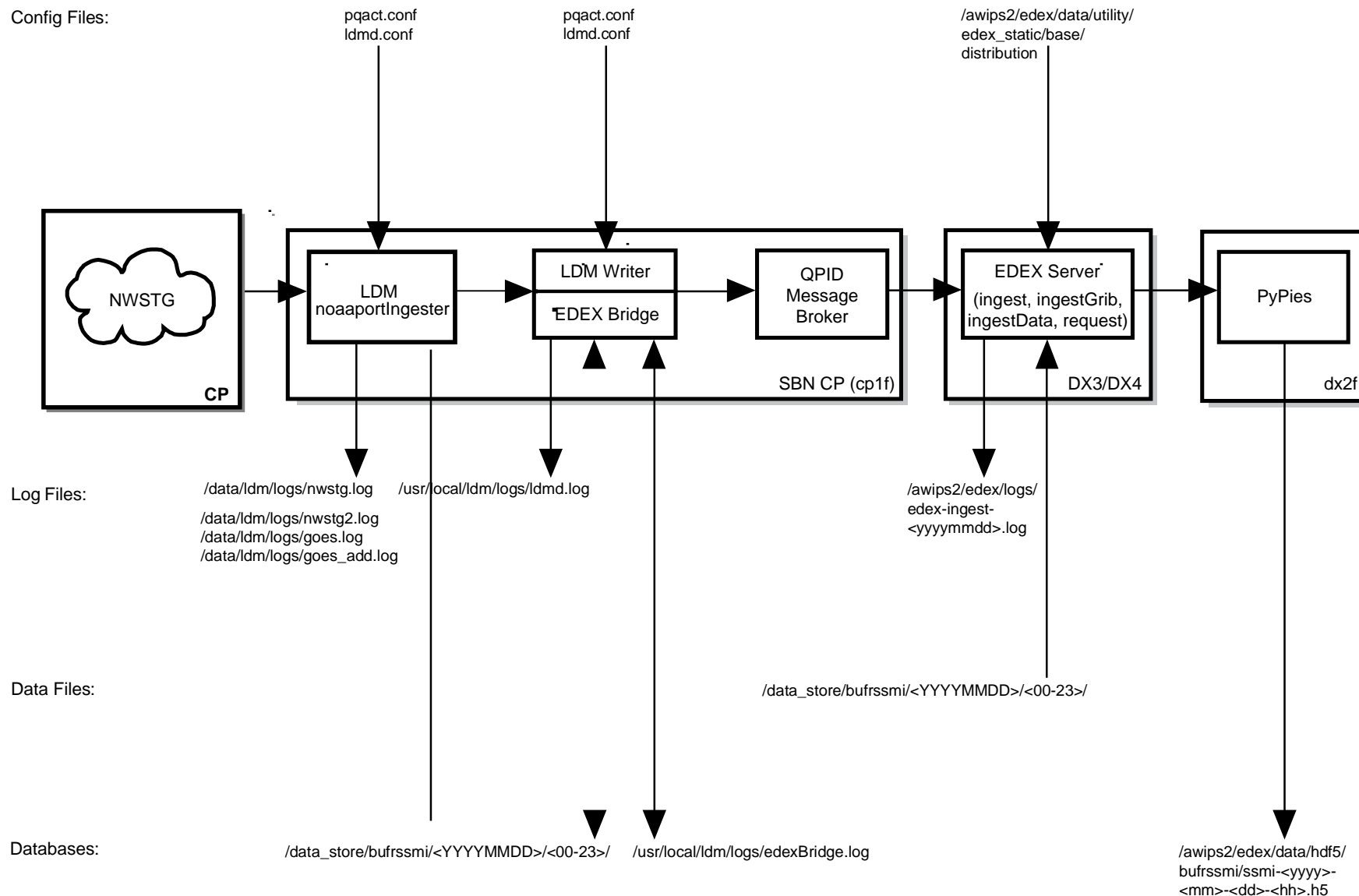

Exhibit B.2-12. Acquire and Ingest of BUFR Products

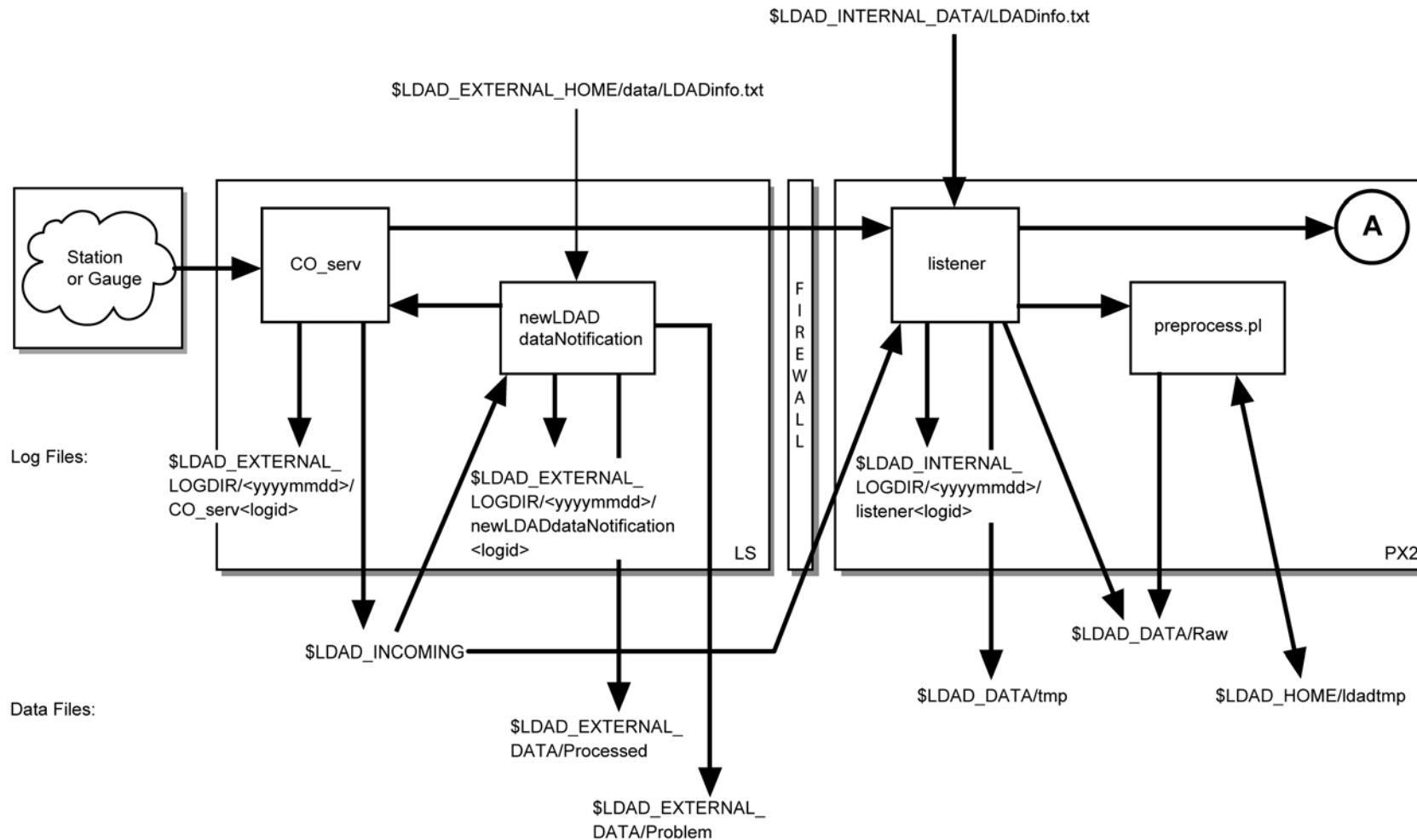

**Exhibit B.2-13. Acquire and Ingest of Synoptic Products**



**Exhibit B.2-14. Acquire and Ingest of SSM/I Products**

Config Files:



SMM 02/09/11

Exhibit B.2-15. Generic Acquire and Decode LDAD Product (Page 1 of 2)

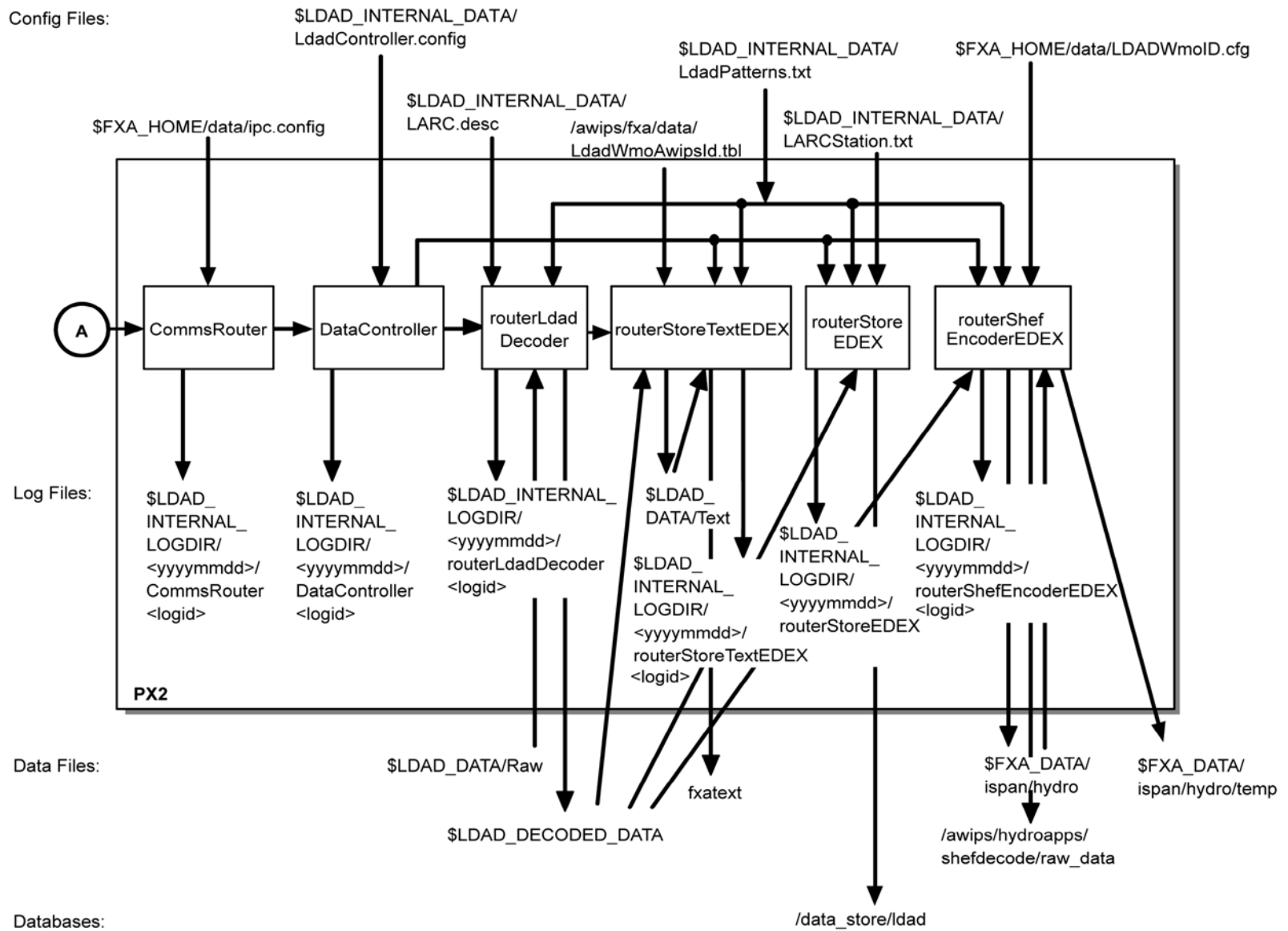

SMM 07/13/10

Exhibit B.2-15. Generic Acquire and Decode LDAD Product (Page 2 of 2)



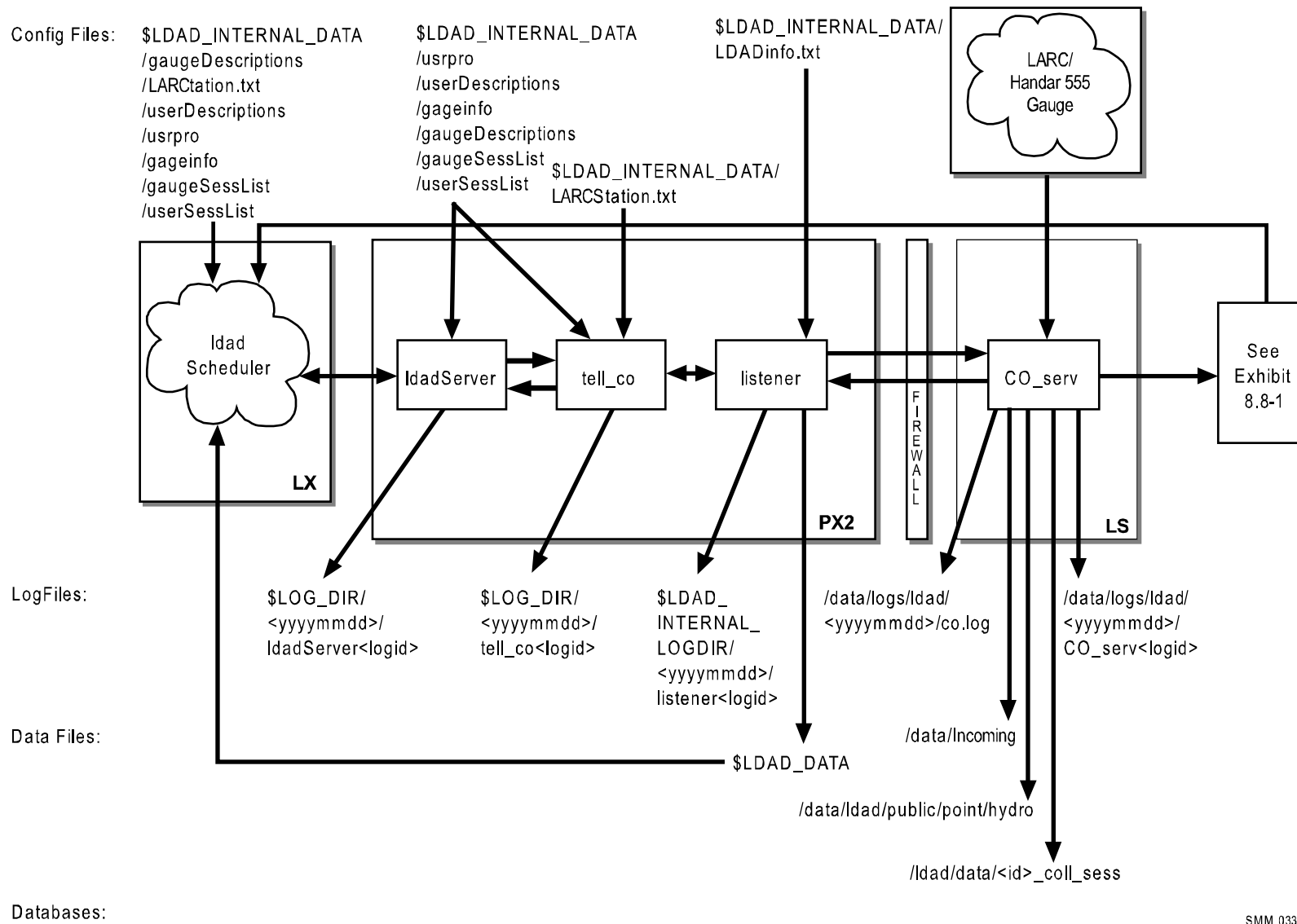

SMM\_033111

**Exhibit B.2-16. Acquire LARC/Handar 555 Data (for LDAD)**

Config Files:

\$LDAD\_INTERNAL\_DATA/  
LDADinfo.txt

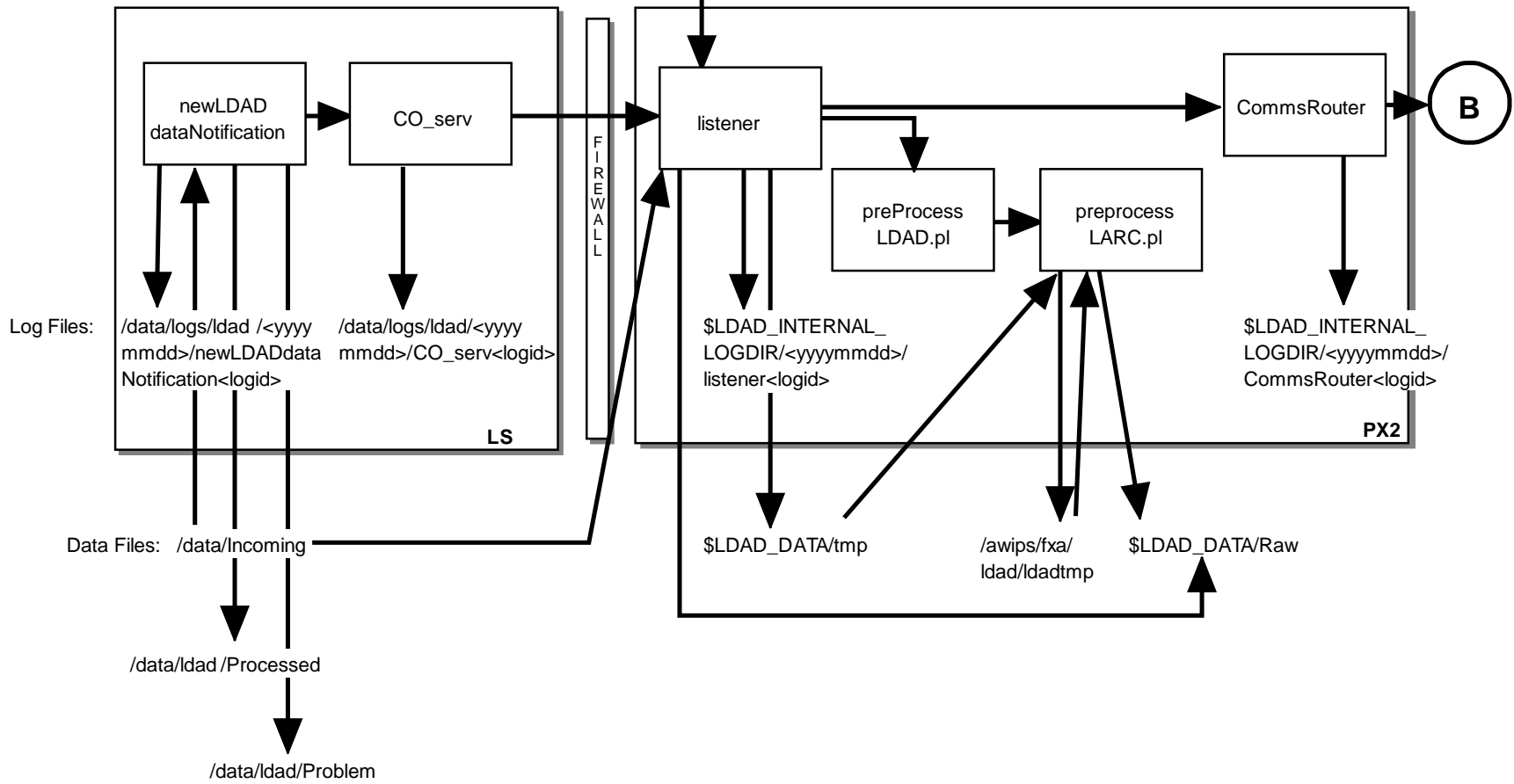

Databases:

SMM 07/13/06

Exhibit B.2-17. Decode LARC/Handar 555 Data (for LDAD) (Page 1 of 2)

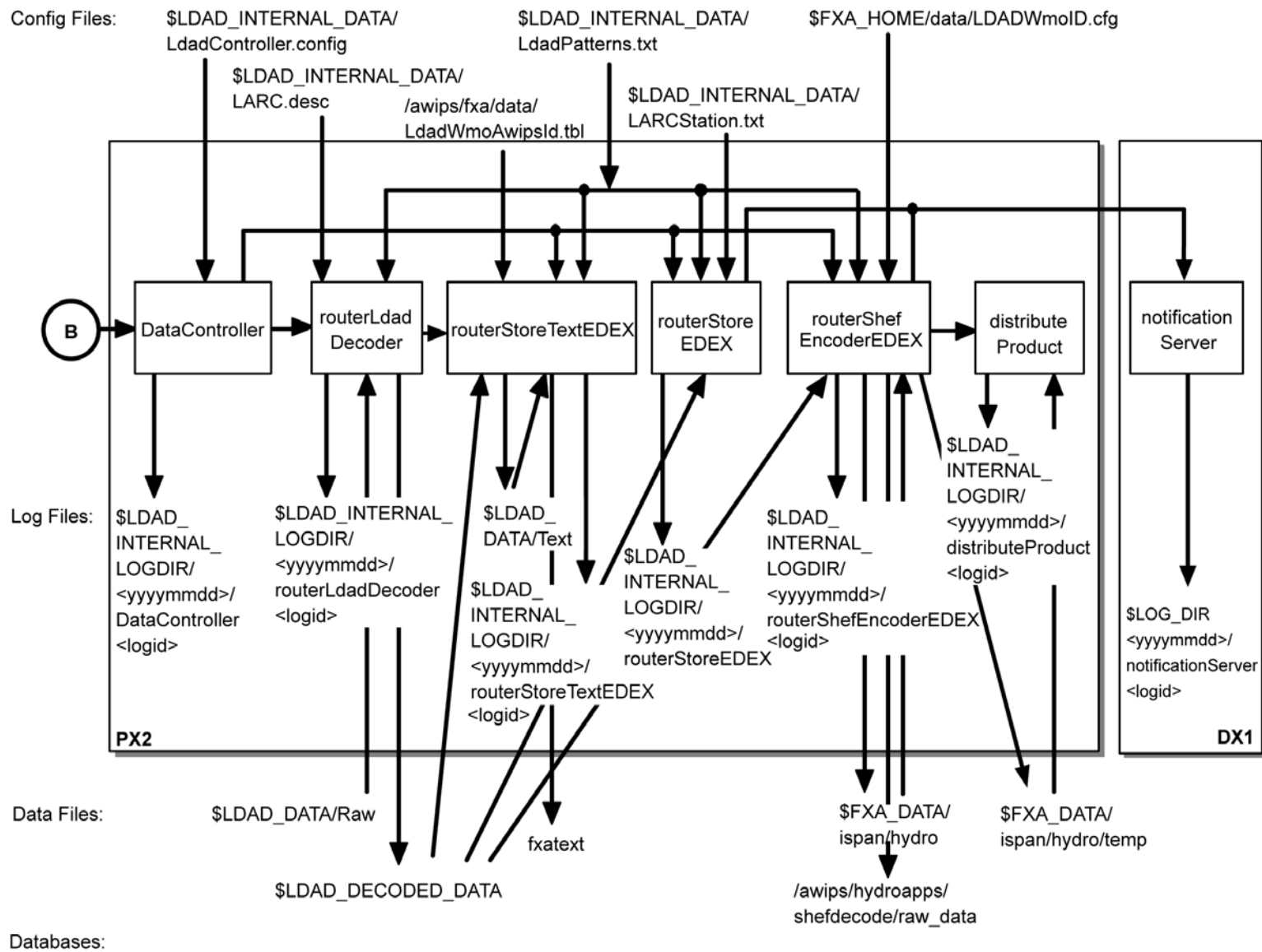

SMM 07/13/10

**Exhibit B.2-17. Decode LARC/Handar 555 Data (for LDAD) (Page 2 of 2)**

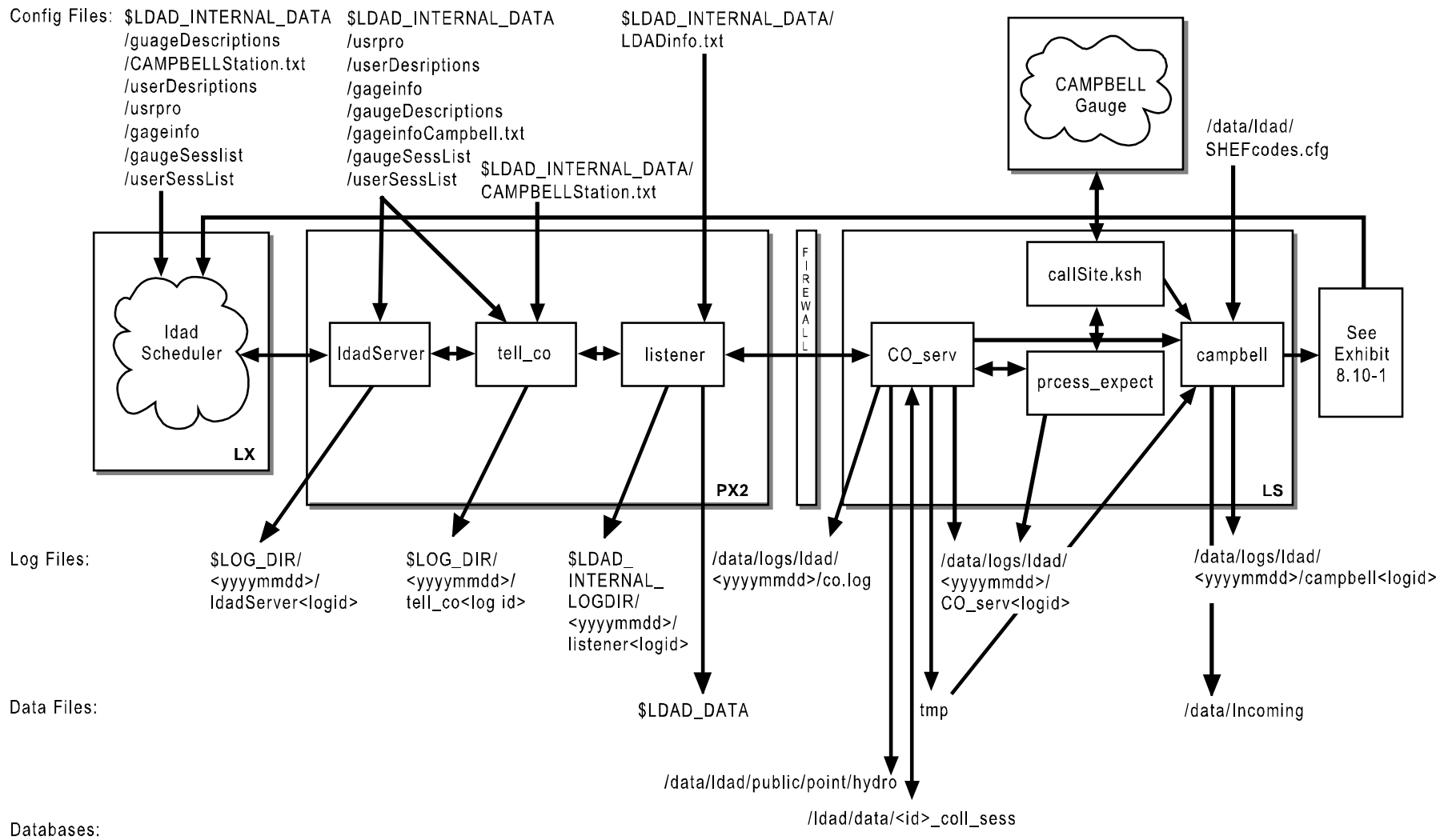

SMM\_033111

**Exhibit B.2-18. Acquire Campbell Data (for LDAD)**

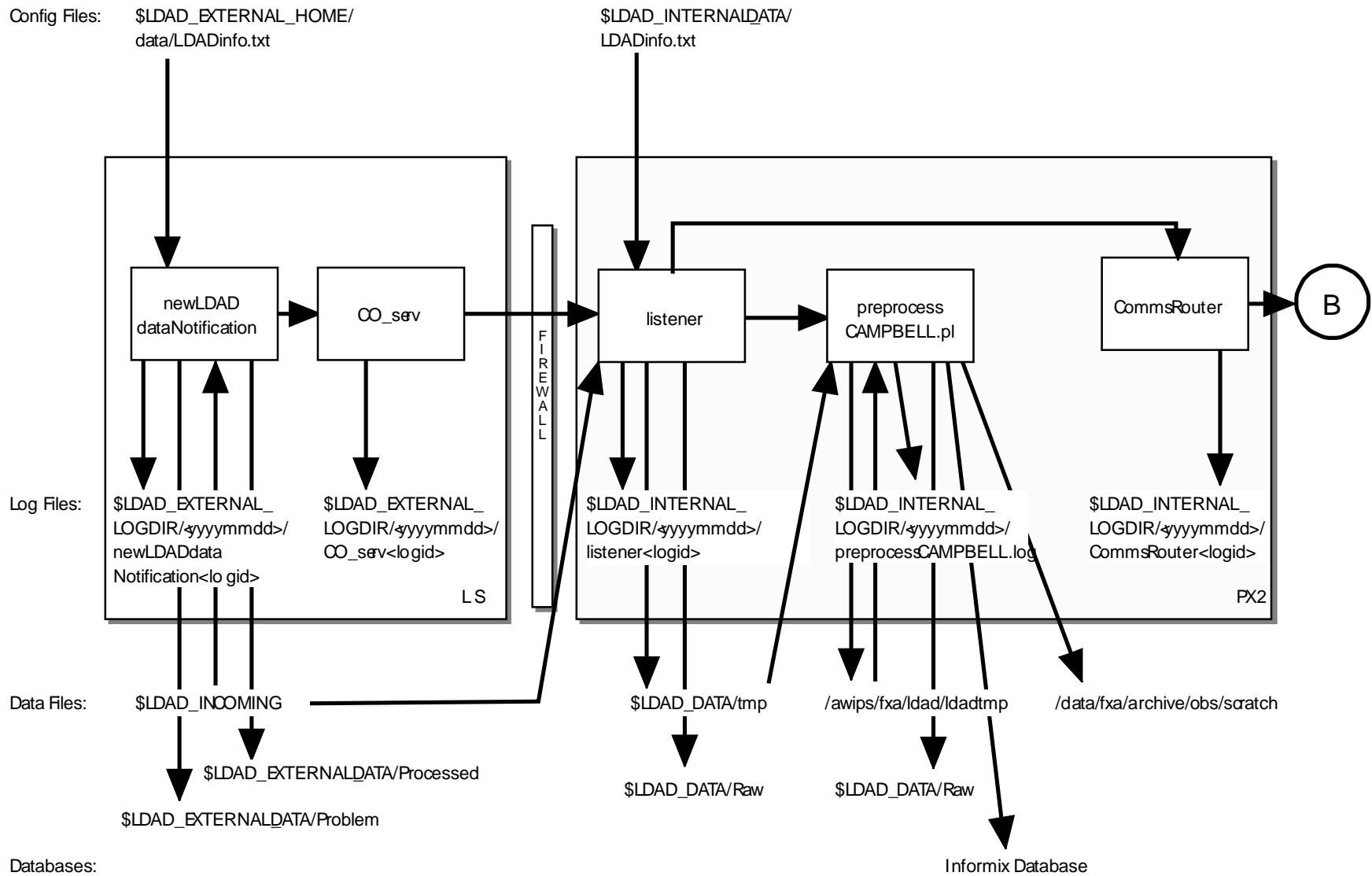

SMM 06/14/06

Exhibit B.2-19. Decode Campbell Data (for LDAD) (Page 1 of 2)

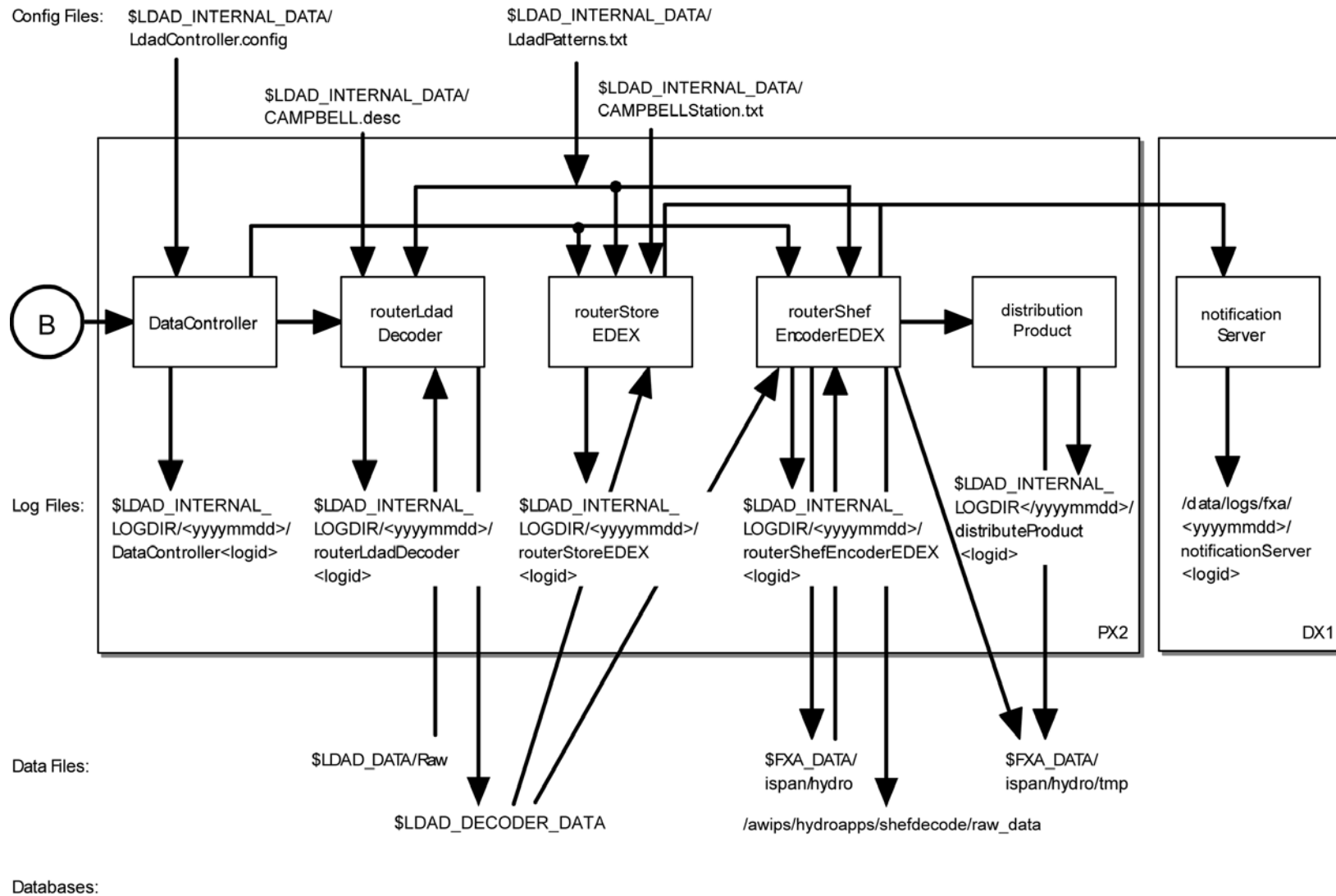

SMM 02/09/11

Exhibit B.2-19. Decode Campbell Data (for LDAD) (Page 2 of 2)

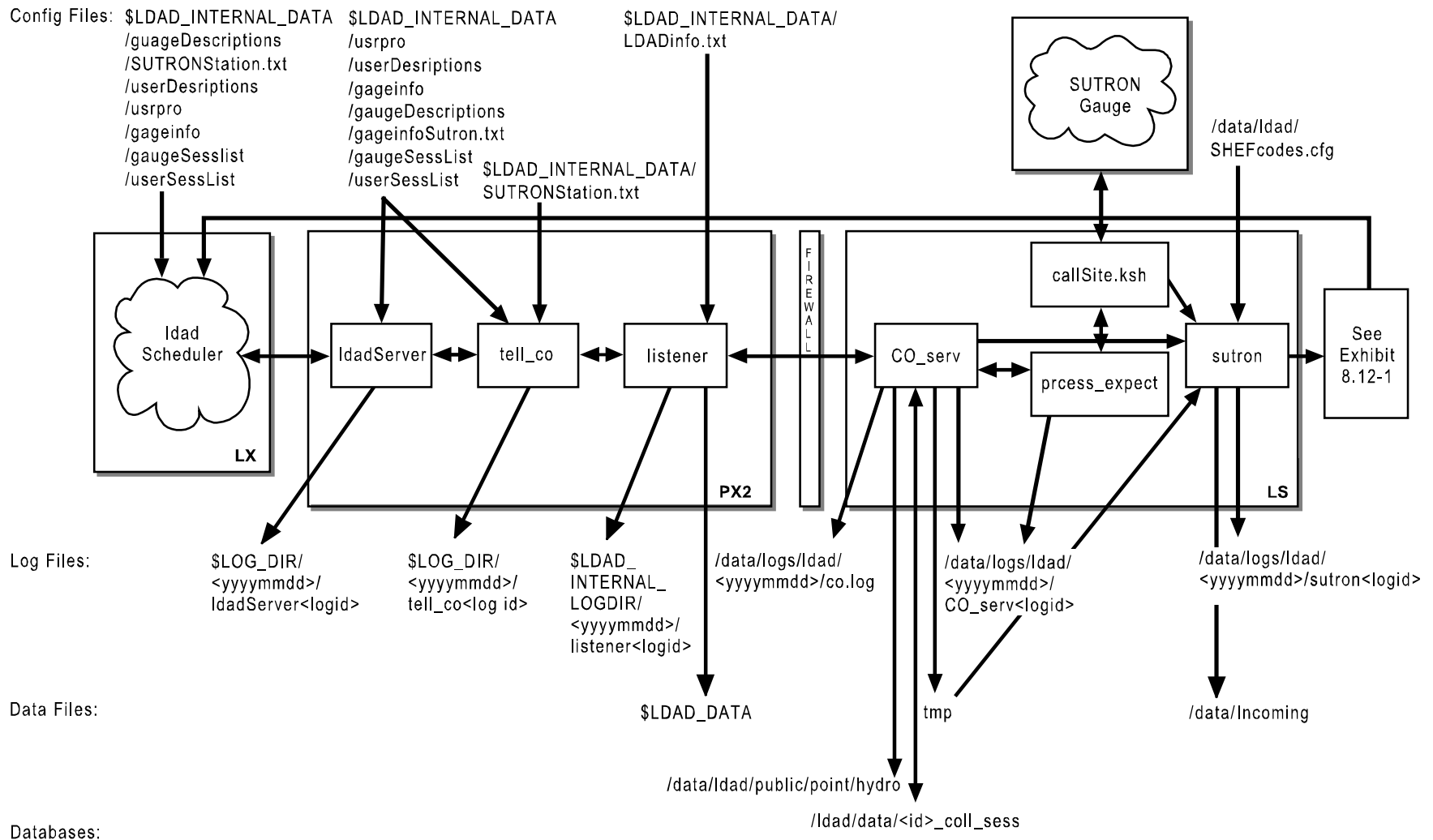

SMM\_033111

**Exhibit B.2-20. Acquire Sutron Data (for LDAD)**

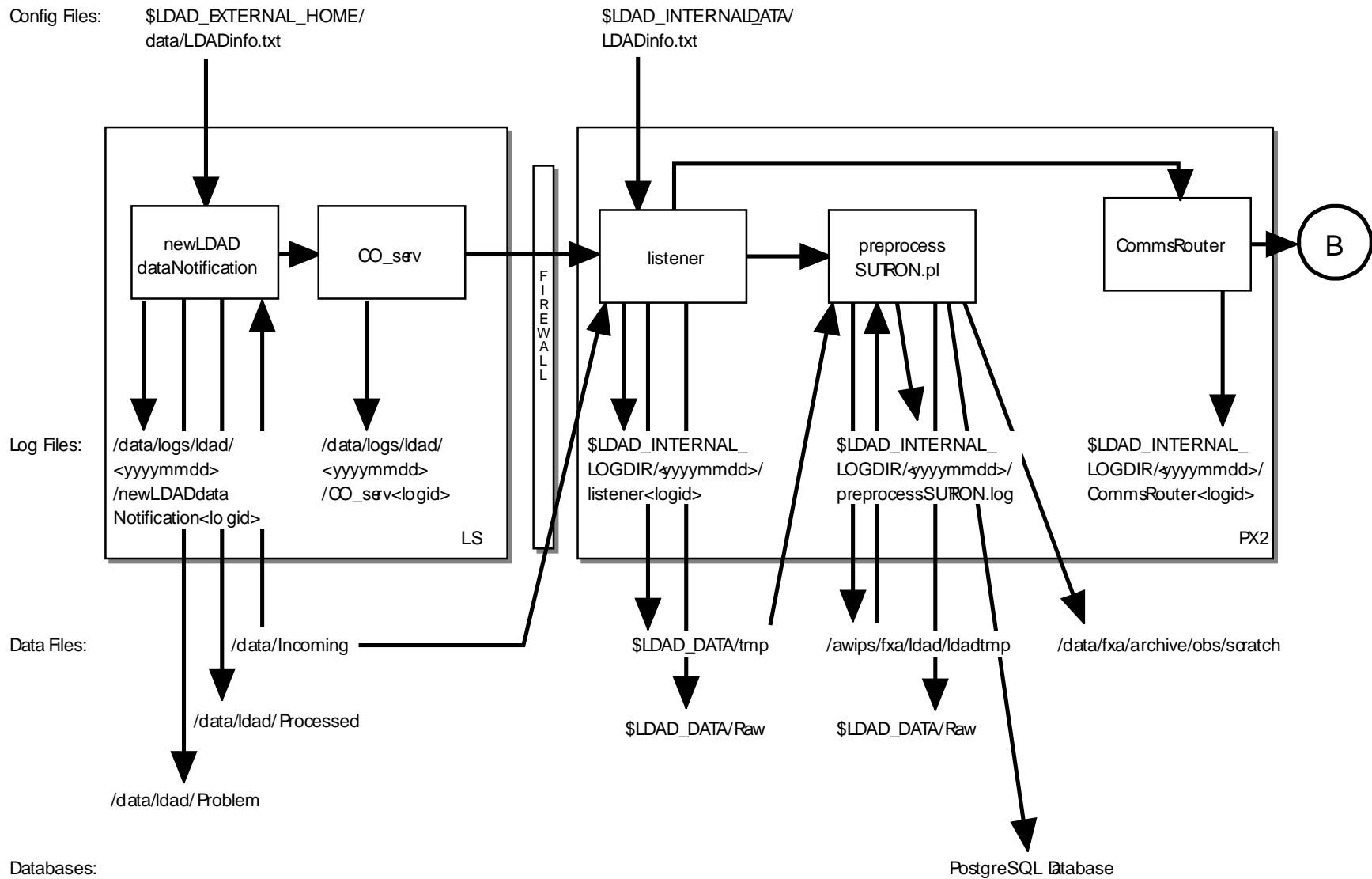

SMM 06/14/06

Exhibit B.2-21. Decode Sutron Data (for LDAD) (Page 1 of 2)



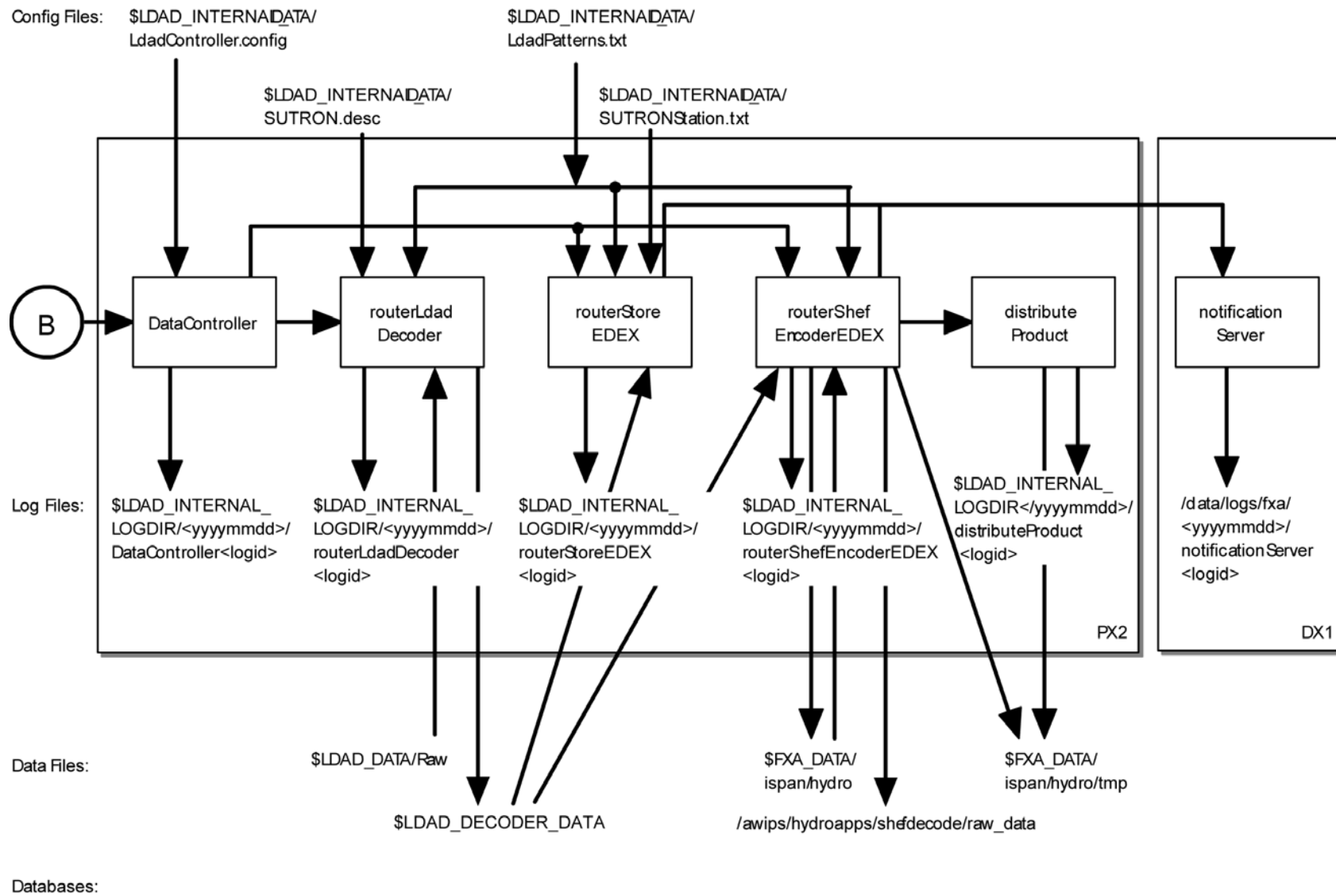

SMM 07/13/10

**Exhibit B.2-21. Decode Sutron Data (for LDAD) (Page 2 of 2)**

Config Files:

\$LDAD\_EXTERNAL\_HOME/data/LDADinfo.txt

\$LDAD\_INTERNALDATA/LDADinfo.txt

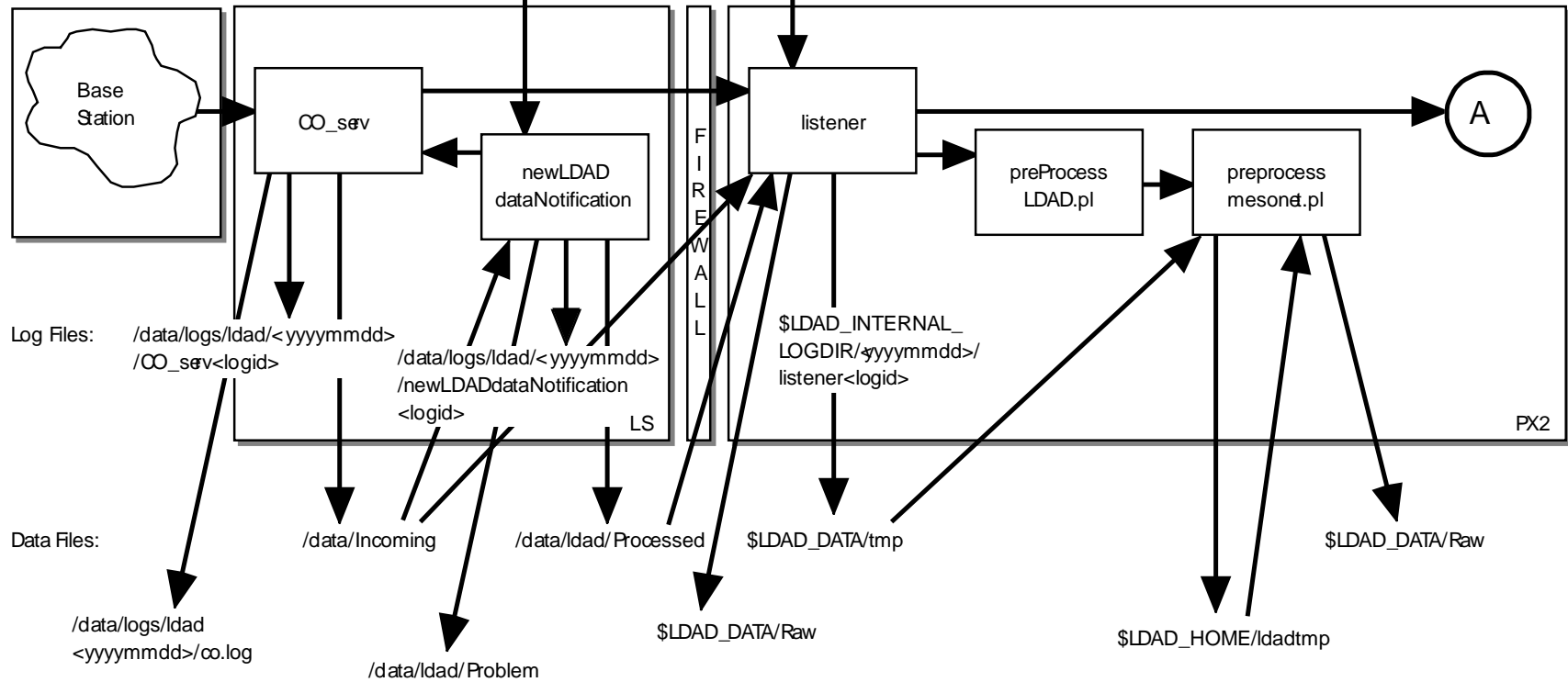

SMM 06/14/06

Exhibit B.2-22. Acquire and Decode Comma Separated Variable Mesonet Data (for LDAD) (Page 1 of 2)

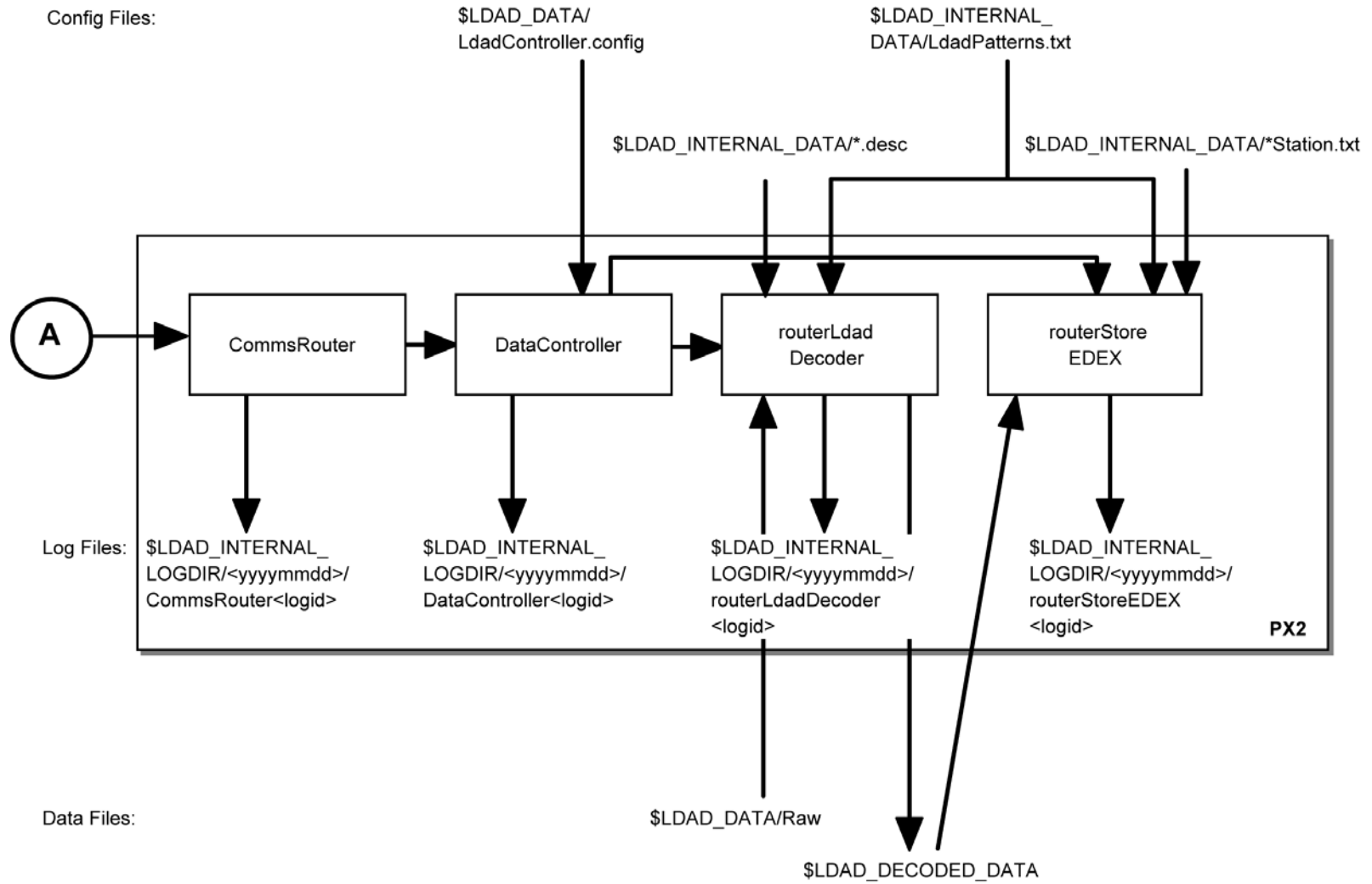

SMM 07/13/10

Exhibit B.2-22. Acquire and Decode Comma Separated Variable Mesonet Data (for LDAD) (Page 2 of 2)

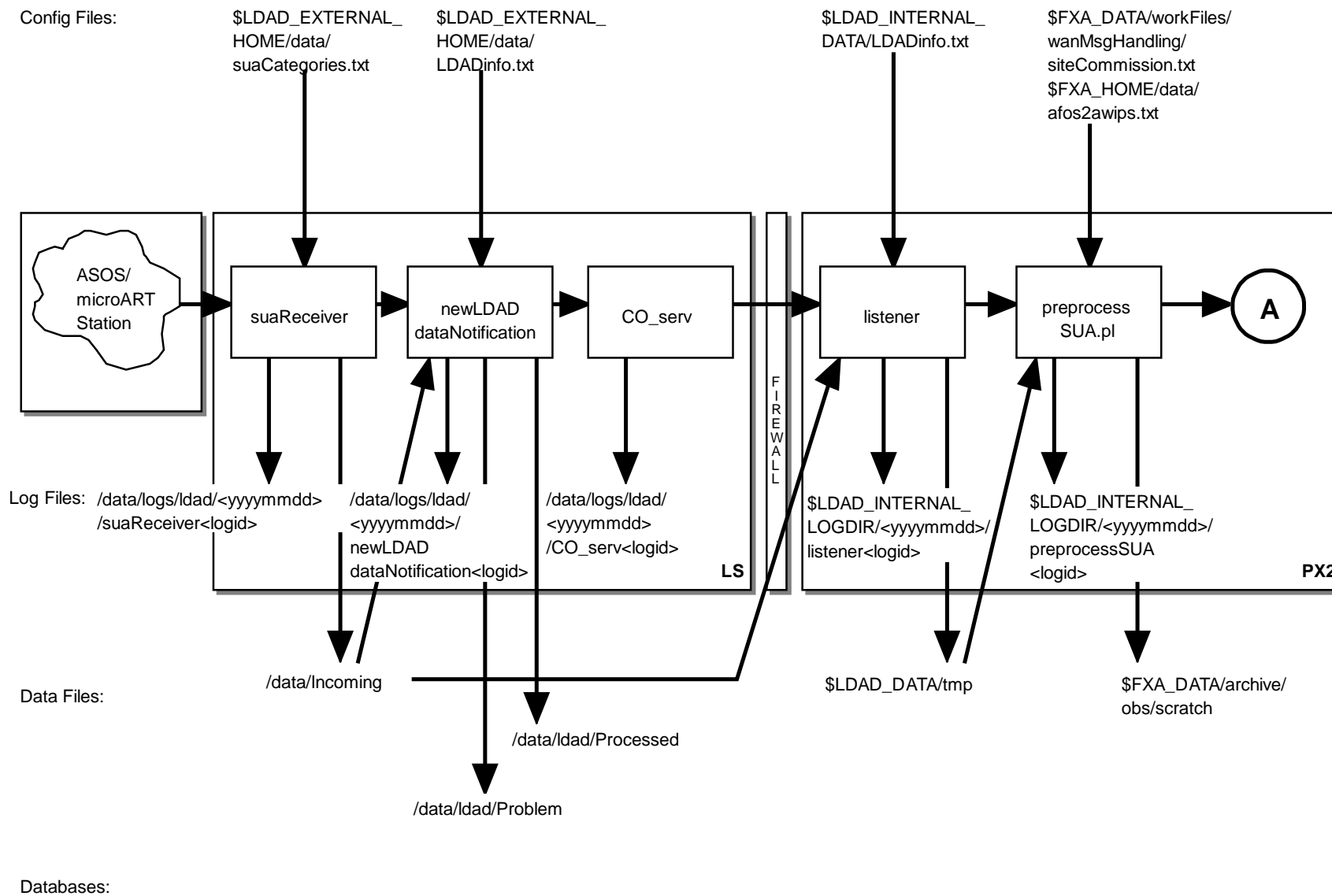

SMM 06/14/06

**Exhibit B.2-23. Acquire and Process ASOS/MicroART Data (for LDAD) (Page 1 of 2)**

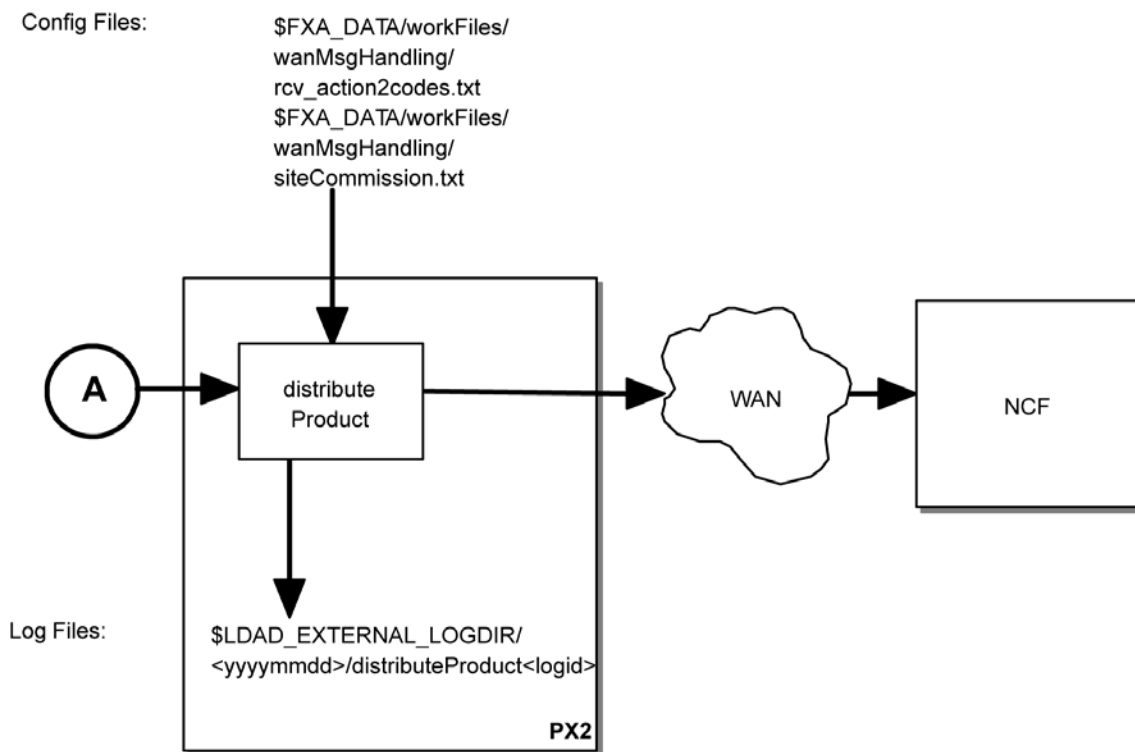

SMM 07/13/10

**Exhibit B.2-23. Acquire and Process ASOS/MicroART Data (for LDAD) (Page 2 of 2)**

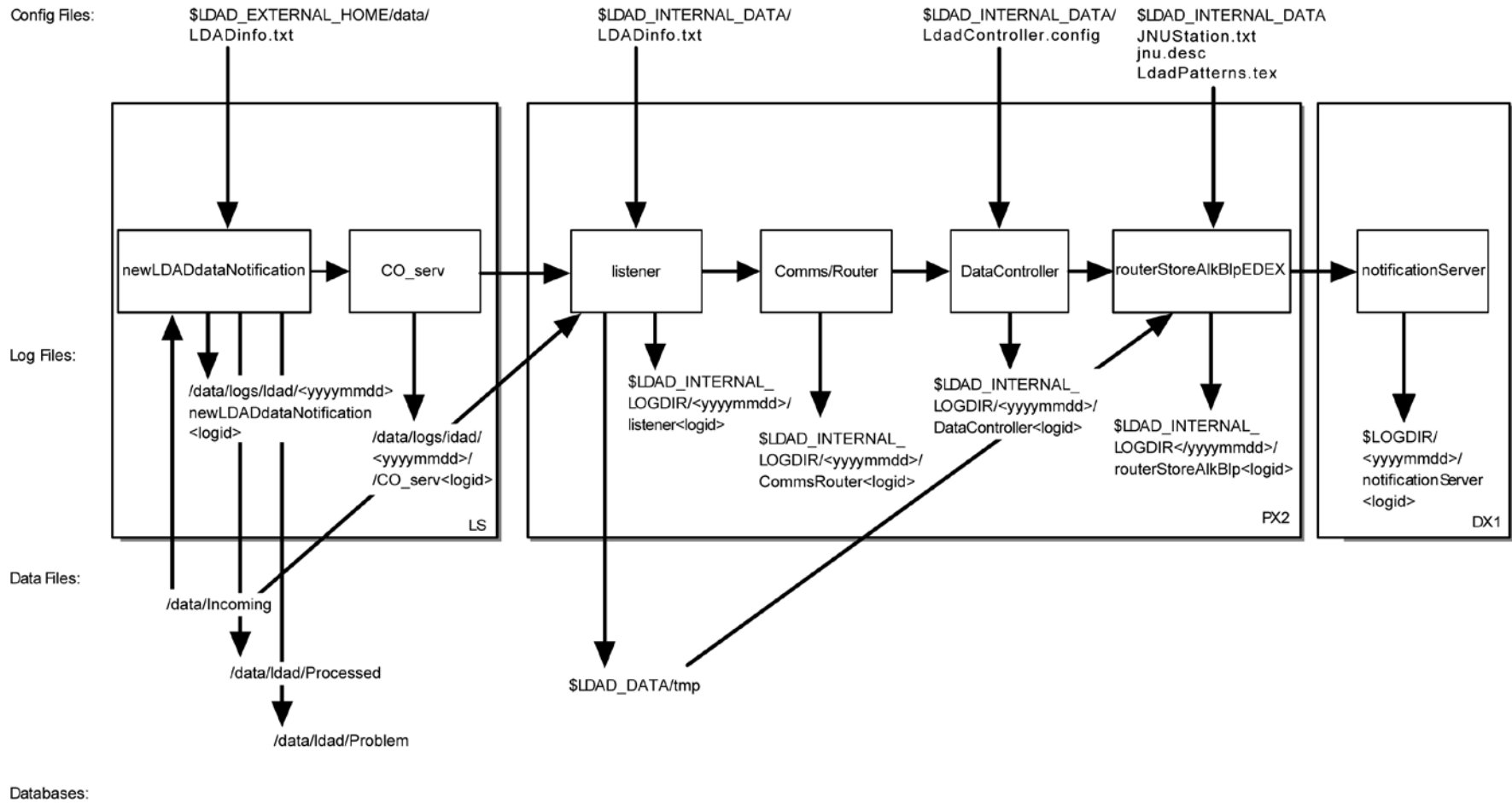

**Exhibit B.2-24. Decode Alaska Profiler Data**

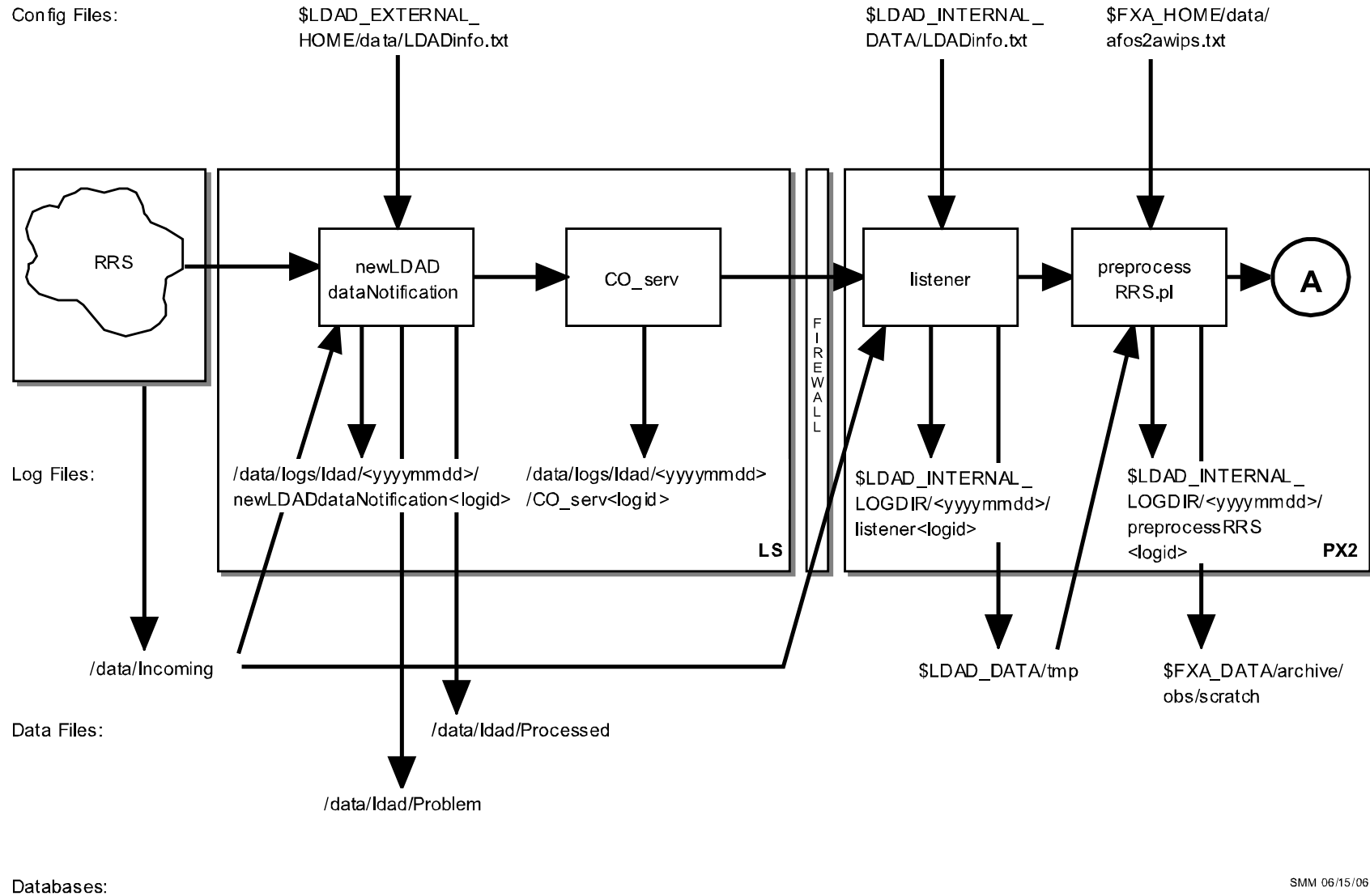

**Exhibit B.2-25. Acquire and Process RRS Data (for LDAD) (Page 1 of 2)**

Config Files: \$FXA\_DATA/workFiles/wanMsgHandling/rcv\_action2codes.txt

\$FXA\_DATA/workFiles/wanMsgHandling/siteCommission.txt

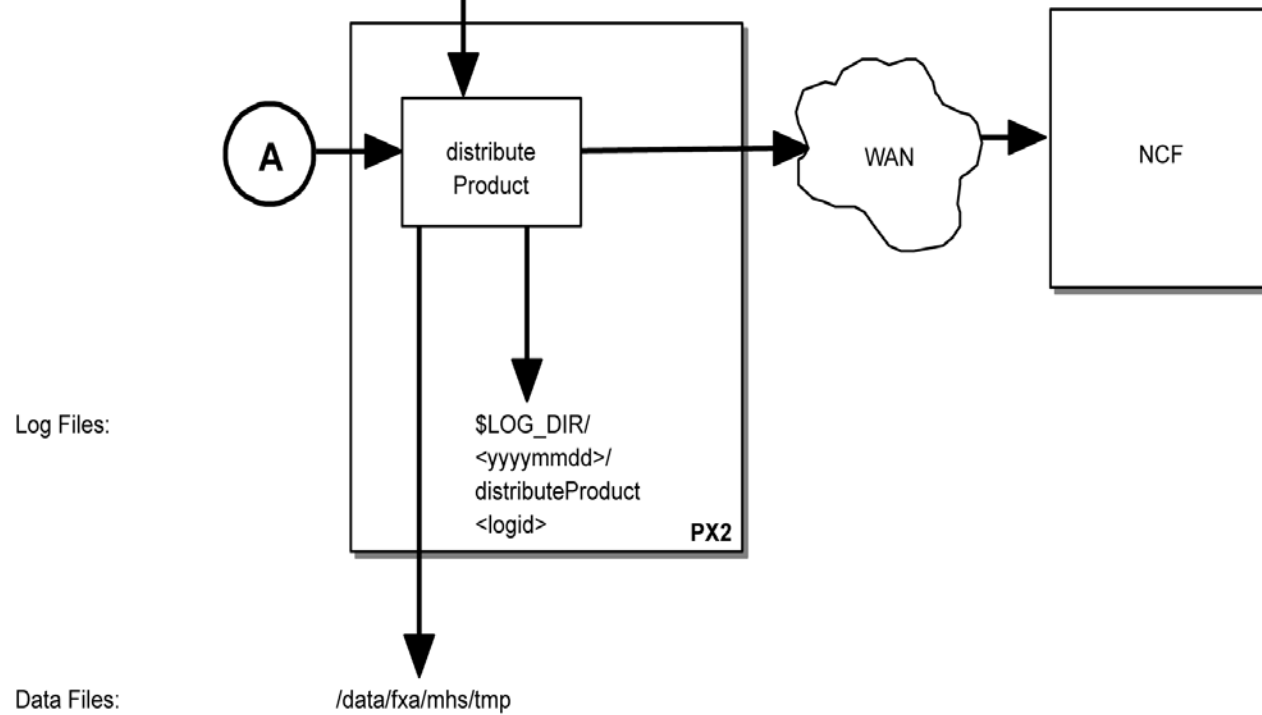

Log Files:

Data Files:

Databases:

SMM 07/13/10

Exhibit B.2-25. Acquire and Process RRS Data (for LDAD) (Page 2 of 2)



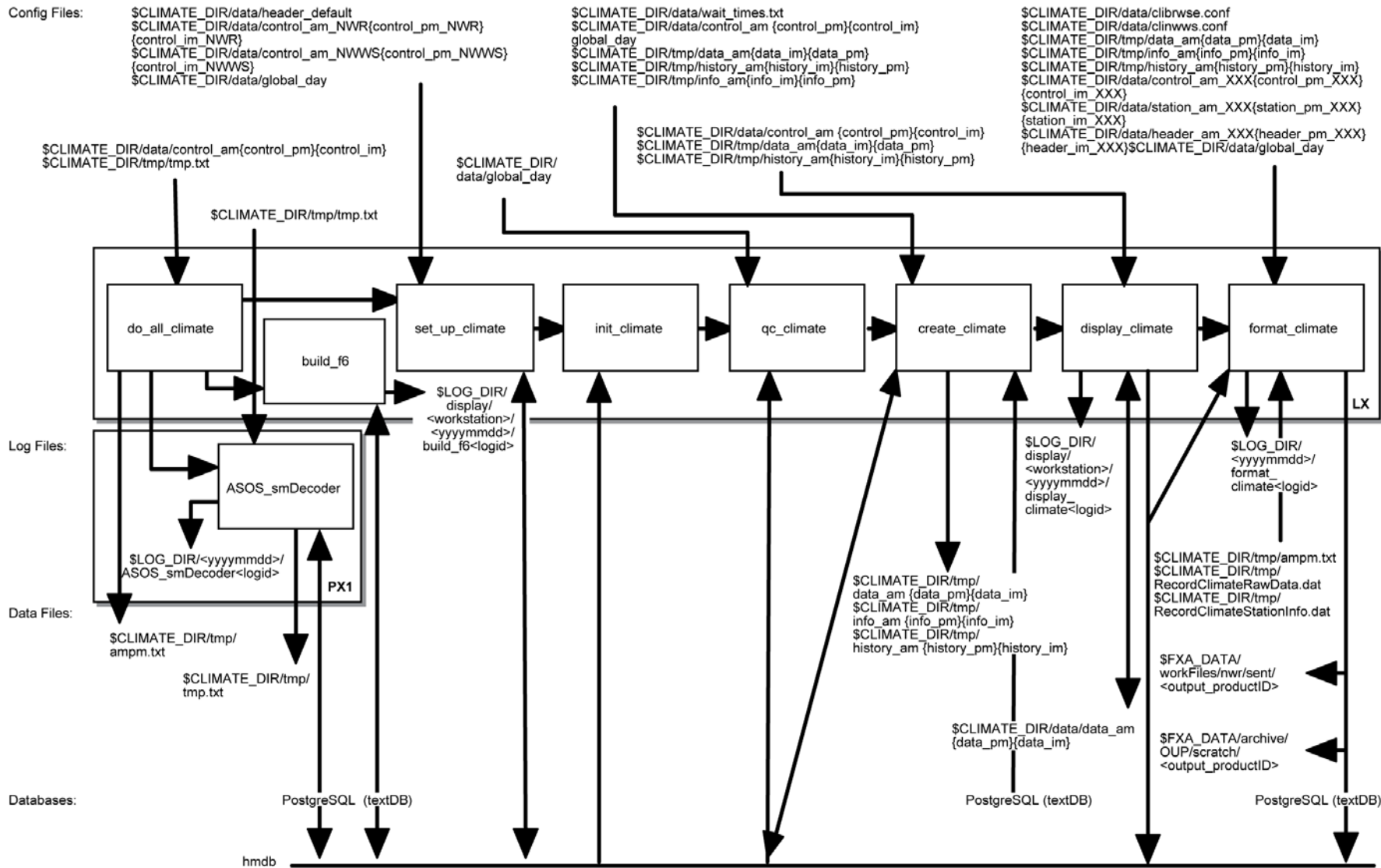

SMM 07/19/10

Exhibit B.2-26. Climatological Reports Formatter for NWR and NWS (Daily)

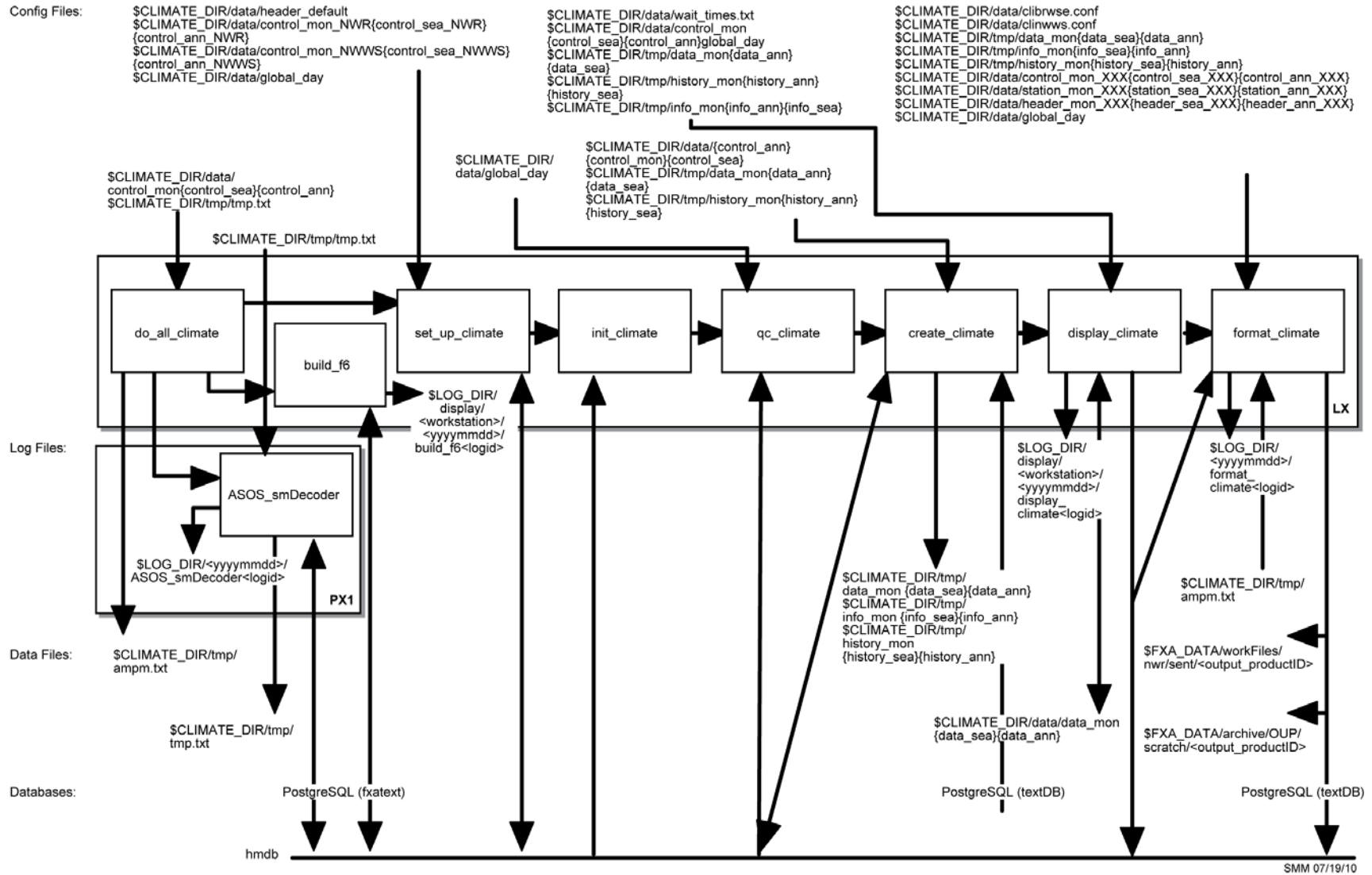

**Exhibit B.2-27. Climatological Reports Formatter for NWR and NWWS (Monthly/Seasonal/Annual)**

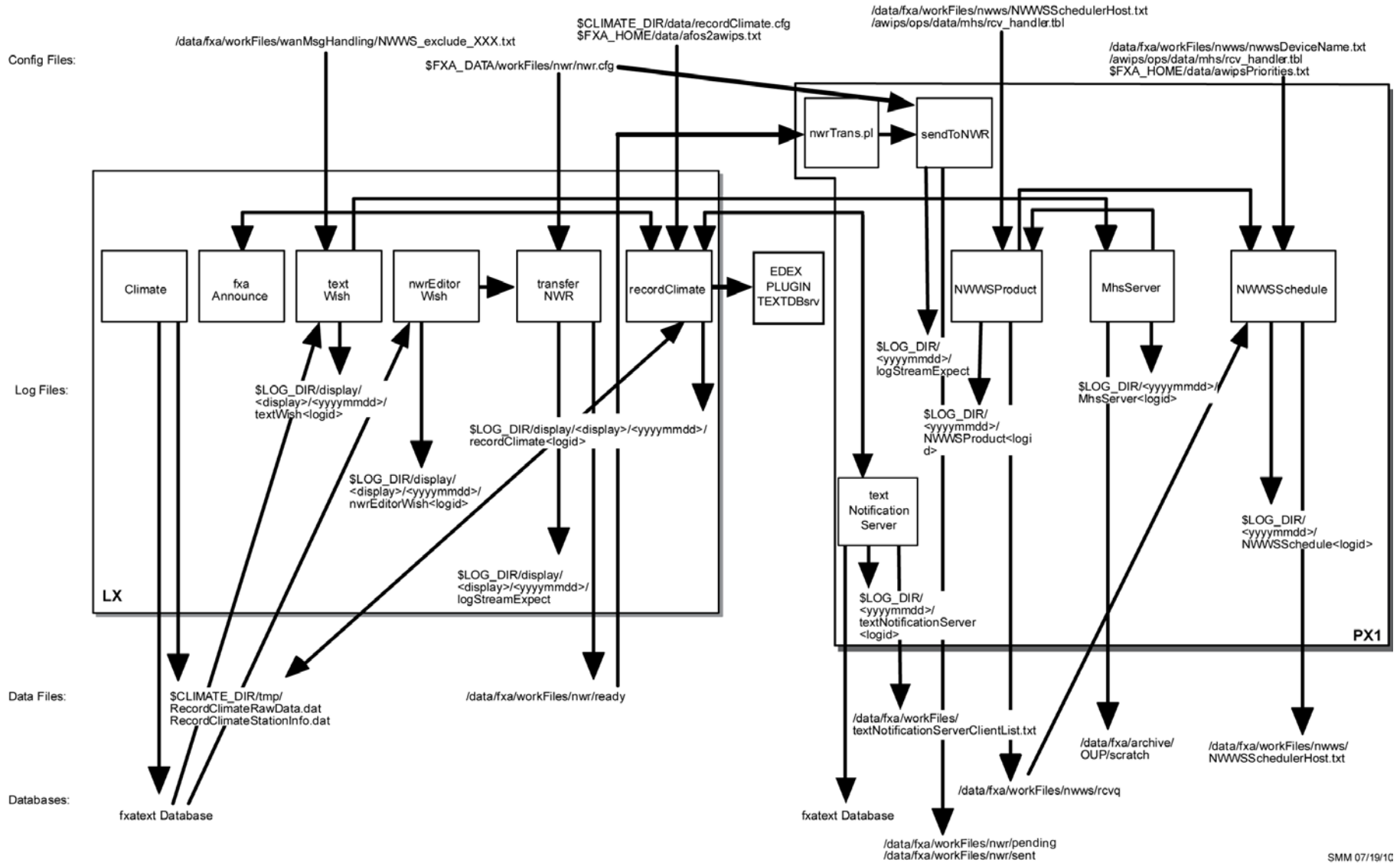

SMM 07/19/10

Exhibit B.2-28. Record Climate Data Flow

Config Files:

\$FXA\_HOME/data/localizationDataSets/  
 <LLL>/wmoSiteId.txt  
 /awips/adapt/hwr/etc/nwws/nwws.config

\$FXA\_HOME/data/afos2awips.txt  
 \$FXA\_HOME/data/awipsSites.txt  
 \$FXA\_HOME/data/localizationDataSets/  
 <LLL>/wmoSiteId.txt

\$FXA\_HOME/data/afos2awips.txt  
 \$FXA\_HOME/data/awipsPriorities.txt  
 \$FXA\_DATA/workFiles/wanMsgHandling/siteCommision.txt  
 \$FXA\_DATA/workFiles/wanMsgHandling/NWWS\_exclude.txt

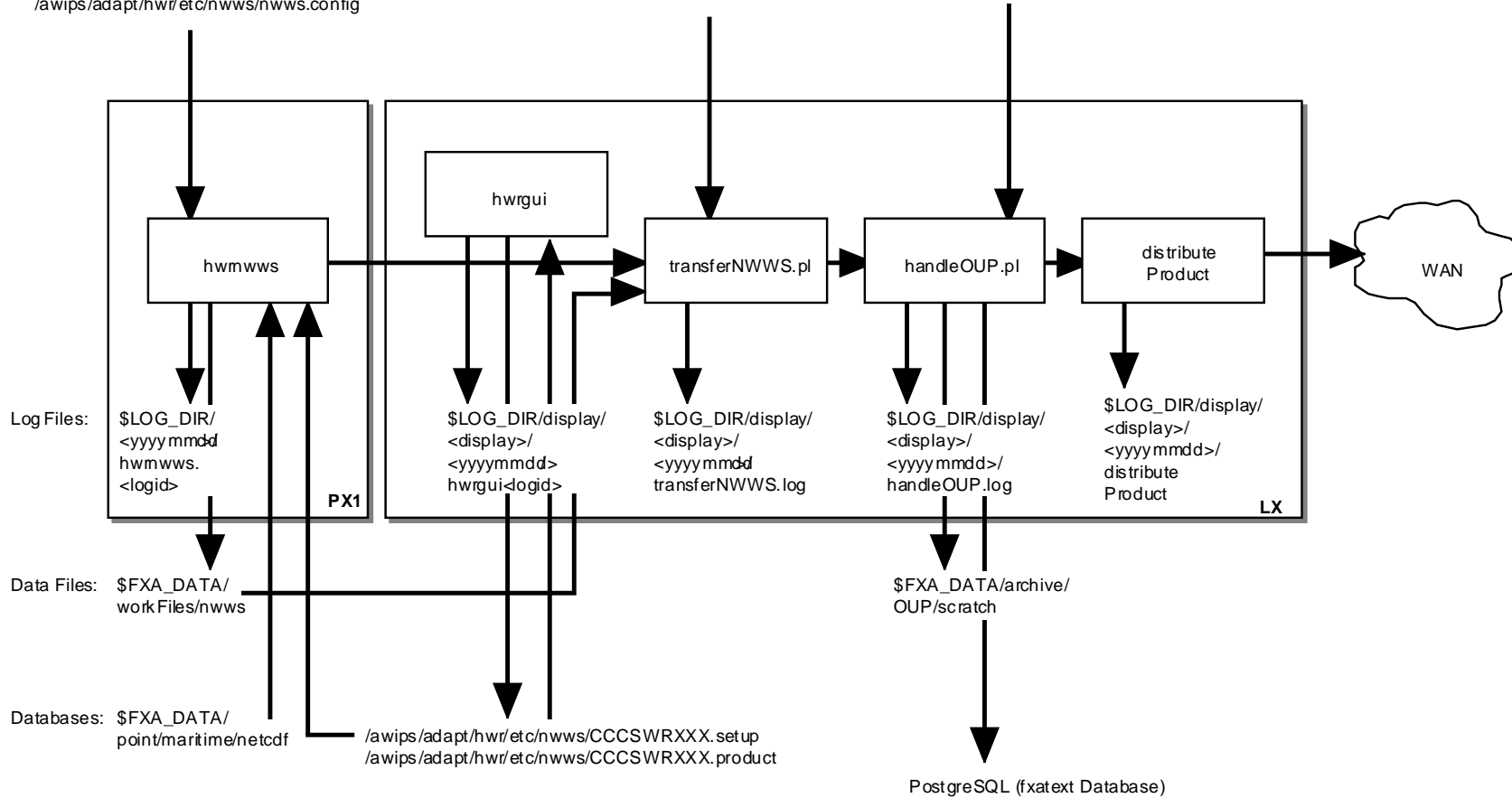

SMM 8/30/05

Exhibit B.2-29. Hourly Weather Roundup Formatter for NOAA Weather Wire Service

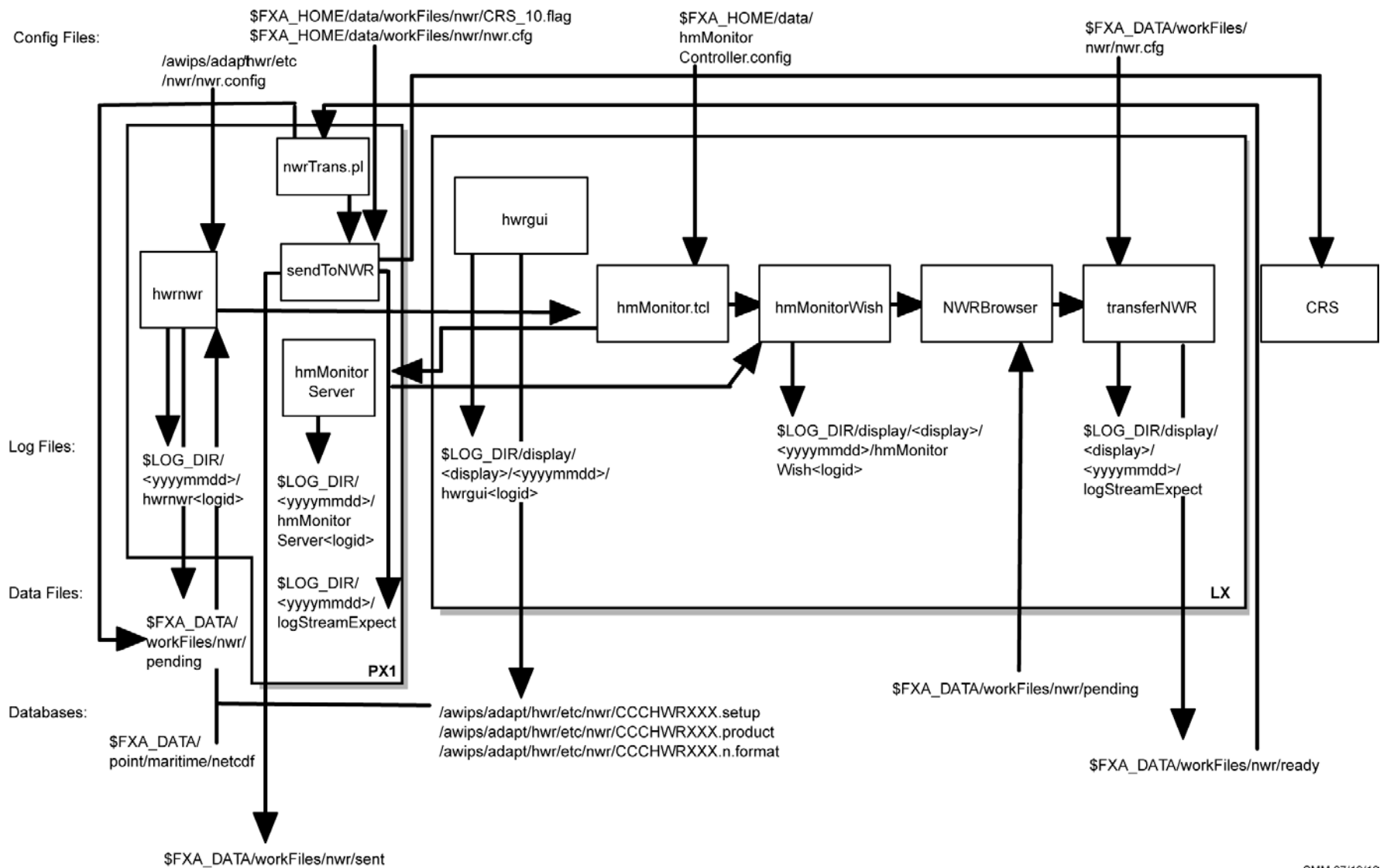

**Exhibit B.2-30. Hourly Weather Roundup Formatter for NOAA Weather Radio**

**Appendix BB: National Centers for Environmental  
Prediction (NCEP)  
AWIPS/NAWIPS Migration Documentation**

## Table of Contents

A2 National Centers for Environment Prediction (NCEP) Information.....	3
A2.1 Introduction:3	
A2.1.1: NCEP Organization Overview.....	3
A2.1.2: NCEP Central Operations .....	3
A2.1.3: The National Centers .....	3
A2.1.4: NCEP AWIPS node names .....	4
A2.2: NATIONAL CENTER HARDWARE PROFILE .....	6
A2.2.1: National Center Rack Elevation.....	6
A2.2.2: National Center Remote Center Testbed .....	7
A2.3: NATIONAL CENTERS AWIPS CONFIGURATION.....	9
A2.3.1: Product Dissemination System (PDS) .....	9
A2.3.2: NCEP Non-Satellite Broadcast Network (NSBN) Data Flow .....	10
A2.3.3: NSBN Data Network Interfaces.....	14
A2.3.4: NSBN Ingest .....	20
A2.3.4.1: NSBN Environment .....	21
A2.3.4.2: NSBN Software .....	25
A2.3.4.3: NSBN Optimization.....	30
Attachment A: NSBN Initial Installation.....	32
Attachment B: NCF Standard Operating Procedures (SOPs).....	36
NCF NSBN SOP 1: Restart NSBN AWIPS processes in OPERATIONAL MODE.....	38
NCF NSBN SOP2: Restart NSBN AWIPS processes in ARCHIVE-ONLY .....	39
NCF NSBN SOP3: Troubleshooting NSBN Ingest Issues .....	40

## A2 National Centers for Environment Prediction (NCEP) Information

### A2.1 Introduction:

This section provides an overview of the NCEP Organization, NCEP Central Operations, and a brief introduction to each of the National Centers and their mission and finally, a detailed description of NCEP AWIPS node names.

#### A2.1.1: NCEP Organization Overview

The United States National Centers for Environmental Prediction (NCEP) delivers national and global weather, water, climate and space weather guidance, forecasts, warnings and analyses to its partners and external user communities. These products and services are based on a service-science legacy and respond to user needs to protect life and property, enhance that Nation's economy, and support the Nation's growing need for environmental information.

“The Centers,” as they are often referred to, are further identified by their geographical proximity, colloquially, as “Remote Centers” for those that are not within the Washington DC Metropolitan Area and/or those centers not part of the centralized operations within the NCEP Central Operations branch (see Section A2.1.2). Those within the Washington DC Metropolitan Area are sometimes referred to as the “WWB Centers,” or perhaps “NCWCP Centers”. The operational centers (i.e. those utilizing AWIPS/NAWIPS and issuing forecasts) part of the Metropolitan Washington DC NCEP organization are the Hydrometeorological Prediction Center (HPC), the Ocean Prediction Center (OPC), and the Climate Prediction Center (CPC)

#### A2.1.2: NCEP Central Operations

The centralized operations for the Remote Centers is performed at NCEP Central Operations (NCO). The NCO executes the NCEP operational model suite that comprises of climate, weather, ocean, space and environmental hazard products and manages improvements to the NCEP model suite within the center for Centralized Computing Services (CCS); supports the research, development, and transition of new or enhanced models to operations; develops meteorological software used by the NCEP Centers to create forecaster-generated products within in the Systems Integration Branch (SIB); manages the flow of data and products to and from the NCEP centers, partners, and customers within the Shared Infrastructure Services Branch (SISB) and Product Management Branch (PMB).

#### A2.1.3: The National Centers

The Office of the Director at the National Centers for Environmental Prediction gives over-arching management to the nine centers, which include the:

**Aviation Weather Center (AWC)** provides aviation warnings and forecasts of hazardous flight conditions at all levels within domestic and international air space.



**Climate Prediction Center (CPC)** monitors and forecasts short-term climate fluctuations and provides information on the effects climate patterns can have on the nation.

**Environmental Modeling Center (EMC)** develops and improves numerical weather, climate, hydrological and ocean prediction through a broad program in partnership with the research community.

**NCEP Central Operations (NCO)** sustains and executes the operational suite of numerical analyses and forecast models and prepares NCEP products for dissemination.

**National Hurricane Center (NHC)** provides forecasts of the movement and strength of tropical weather systems and issues watches and warnings for the U.S. and surrounding areas.

**Ocean Prediction Center (OPC)** issues weather warnings and forecasts out to five days for the Atlantic and Pacific Oceans north of 30 degrees North.

**Space Weather Prediction Center (SWPC)** provides space weather alerts and warnings for disturbances that can affect people and equipment working in space and on earth.

**Storm Prediction Center (SPC)** provides tornado and severe weather watches for the contiguous United States along with a suite of hazardous weather forecasts.

**Weather Prediction Center (WPC)** previously Hydrometeorological Prediction Center provides nationwide analysis and forecast guidance products out through seven days.

Most of the NCs further delineate internally, on a center-level, the functionality of their mission by “desk.” For example, at the NCO there is a Senior Duty Meteorologist (SDM) who is responsible for the operational aspects of the NCO functions. These desk-level functions are incorporated into the CAVE localization identifiers discussed later in this appendix.

**A2.1.4: NCEP AWIPS node names**

The NCs underwent a complete hardware refresh of the AWIPS baseline. Within the task is the spin-up of new AWIPS nodes that ran in parallel to the existing AWIPS systems and eventually replaced them once testing and evaluation were completed. The current architecture has two systems, one WFO and one RFC, at each NC. The new architecture has a single system, so named a NC system. This will be discussed later in the appendix.

For now, the naming convention and AWIPS node names for the new NC systems are as follows in Table A2.1.4-1 and Table A2.1.4-2 below.

**Table A2.1.4-1: National Center AWIPS node naming convention**

First three letters of the site name acronym	A capital letter ‘N’ for NC
<p><i>For example,</i></p> <p>The Aviation Weather Center = AWC</p> <p>The Space Weather Prediction Center = SWP</p>	<p><i>This denotes the hardware platform is that for a National Center and not necessarily that the site is a National Center.</i></p>

*The Storm Prediction Center = SPC*

**Table A2.1.4-2: National Centers hardware platforms**

AWIPS Node Name NWS Name	National Center Name (Building Name) <i>*if applicable</i>	Location
<b>AWCN</b> NOAA/NWS/NCEP/AWC	<b>Aviation Weather Center</b>	7200 NW 101 <sup>st</sup> Terrace Room 118 Kansas City, MO
<b>CTBN</b> Raytheon/IIS/MOS	<b>Contractor Testbed</b> (Silver Spring Metro Plaza)	8401 Colesville Road Suite 800 Silver Spring, MD
<b>WPC<sub>[M1]</sub></b> NOAA/NWS/NCEP/HPC	<b>Weather Prediction Center</b> (National Center for Weather & Climate Prediction – NCWCP)	5830 University Research Ct, College Park, MD 20740
<b>HTBN</b> NOAA/NWS/NWSHQ	<b>Headquarters Testbed</b>	1323 East-West Highway Silver Spring, MD
<b>NHCN</b> NOAA/NWS/NCEP/NHC	<b>National Hurricane Center</b>	11691 SW 17 <sup>th</sup> Street Miami, FL
<b>NTBN</b> NOAA/NWS/NCEP/NCO	<b>NCO Testbed</b> (National Center for Weather & Climate Prediction – NCWCP)	5830 University Research Ct, College Park, MD 20740
<b>OPCN</b> NOAA/NWS/NCEP/OPC	<b>Oceans Prediction Center</b> (National Center for Weather & Climate Prediction – NCWCP)	5830 University Research Ct, College Park, MD 20740
<b>SPCN</b> NOAA/NWS/NCEP/SPC	<b>Storm Prediction Center</b> (National Weather Center – NWC)	120 David L Boren Blvd. Norman, OK
<b>SWPN</b> NOAA/NWS/NCEP/SWPC	<b>Space Weather Prediction Center</b> (David Skaggs Research Center – DSRC)	320 Broadway Boulder, CO

Note: There is also NC hardware at Alaska Regional Center NCEP System (ARCN) and Site HFON (HFO WFO)

## A2.2: NATIONAL CENTER HARDWARE PROFILE

### A2.2.1: National Center Rack Elevation

The NC Rack Elevation profile is detailed below along with the Remote Centers Testbed (RCT) single rack development platform. Note that some NCs do not conform to the standard Rack Elevation below due to constraints of data center requirements or HVAC considerations with respect to RACK 4 [ SPCN and NHCN have all five NC AWIPS racks; however, all other NCs only have RACK1, RACK2, RACK3, and RACK5. The RCT rack is at AWCN, SPCN, NHCN, and the three centers co-located at the NCWCP facility].

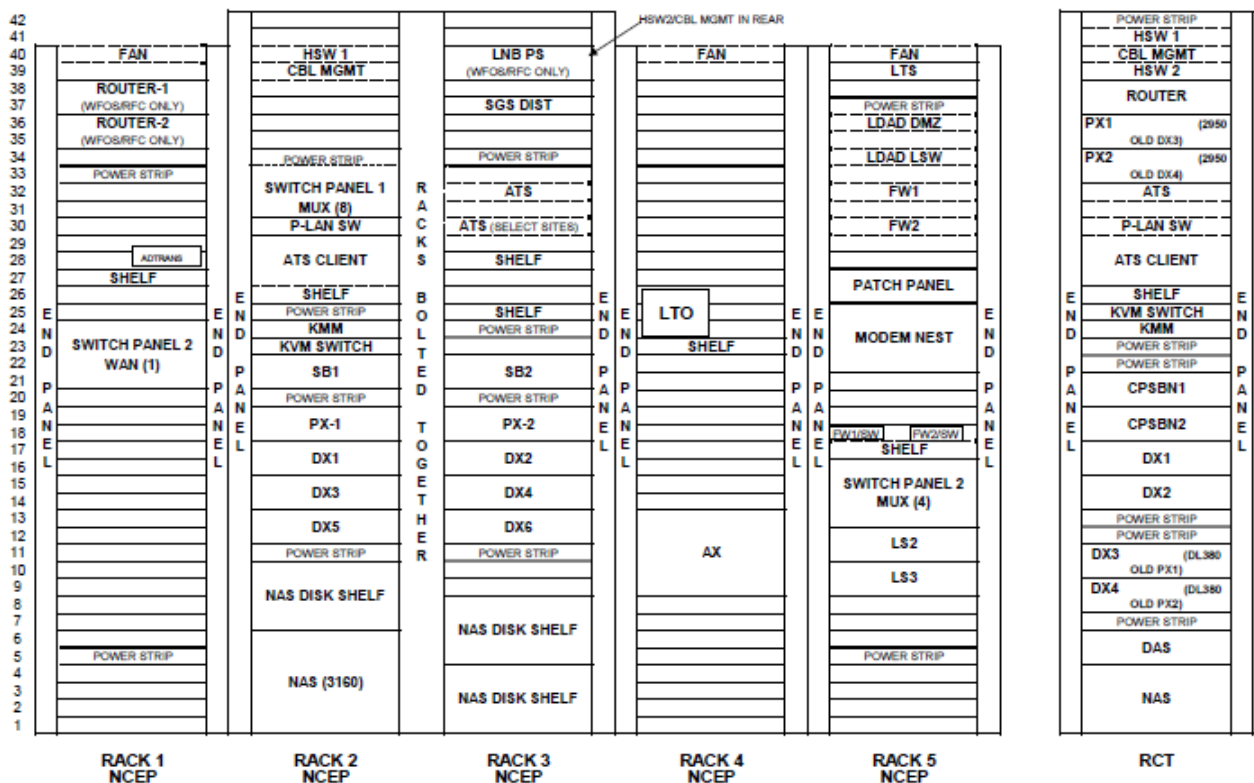

**A2.2.2: National Center Remote Center Testbed**

The NC RCT Rack Elevation profile is detailed below. The NC RCT consists of an entire compliment of baseline WFO hardware Racks 2-3, condensed into a single Dell Commodity rack. The RCT is not on the AWIPS WAN and only accessible via an SSH connection from the co-located operational NC AWIPS system.

The SPCN RCT system is named SPCW; the NHCN RCT system is NHCR; and the AWCN RCT system in named WNAW. These are the legacy AWIPS systems that were once the operational AWIPS. NCWCP (OPCN, HPCN, NTBN) has a single RCT named NHCW.

**Remote Centers Testbed (RCT)**

(Updated: August 9, 2013)

Front Rail		Rear Rail
42	PS1	42
41	HSW1	41
40	Cable Mgmt	40
39	HSW2	39
38	ROUTER1-RCT	38
37		37
36	PX1-RCT	36
35		35
34	PX2-RCT	34
33		33
32	ATS	32
31		31
30	PSW	30
29		29
28	ATS Client	28
27		27
26	Shelf	26
25	KMM	25
24	KMM Switch	24
23	PS2	23
22	PS3	22
21	CPSBN1-RCT	21
20		20
19	CPSBN2-RCT	19
18		18
17	PS4	17
16	DX1-RCT	16
15		15
14	DX2-RCT	14
13		13
12	PS5	12
11	DX3-RCT	11
10		10
9	DX4-RCT	9
8		8
7	PS6	7
6	DAS-RCT	6
5		5
4		4
3	NAS-RCT	3
2		2
1		1

Workstations will be the legacy AWIPSI system re-purposed however additional may be added to the RCT LAN as the HSW½ can provide additional device availability to the testbed

Sites should ensure they do the CPSBN optimization in the AWIPSI Site Migration Guide prior to RCT re-configuration

Site should ensure they do the DX1/DX2 memory upgrade mod note prior to the RCT re-configuration.

Sites should ensure they do the NAS replacement mod note prior to the RCT re-configuration

Dell PE2950s (legacy DX3/DX4)

NOAAport NSBN Ingest

HP DL380G6 (legacy PX1/PX2)

NetApp FAS2020c

NetApp FAS2240

Connection to operational site HSW provides connectivity to RCT only from co-located operational NC ... there is no access to/from RCT from elsewhere on the AWIPS WAN.

Except at SPCW, using PX servers for local PDS system, and at NHCR – the PX servers & DX3/4 were not remapped due to constraints of SOW. Since there is no DX5/DX6 sites may wish to run EDEX on PX1/PX2 as well, however current setup is baseline WFO AWIPSI layout.

NOAAport/SBN ingest calls to operational CPSBN or if line exists run from DVB to RCT.

DX4 baseline has only 8GB of RAM. More can be added but PX1/PX2 will also be used as EDEX servers.

All sites have dedicated COAX run from splitter to the RCT DVBS for the SBN ingest mechanisms to CPSBN1f.

All sites have the WFO/RFC FAS2240-4 NetApp and legacy NetApp FAS2020c devices. FC connections currently to FAS2020c

Hardware Legend

1U Front Facing
1U Rear Facing

Of notable difference between the NC and WFO Rack Elevation are the shown below:

Device	Commission	Functionality & Requirement(s)
<b>LTO</b>	Not Commissioned	<ul style="list-style-type: none"> <li>○ Provides tape backup tethered from archive server PCI-X card and with a direct LAN connection to NAS1.</li> <li>○ There is an LTO Tanberg SCSI-3 tape drive and two media on-site with required cabling however it is not installed.</li> <li>○ Cannot be installed without PCI-X riser which are EOA for all servers except legacy AX server.</li> <li>○ Cannot be installed without open 10/100/1000 Ethernet port on NAS1 which is not available on NC hardware.</li> </ul>
<b>AX</b>	Not Commissioned	<ul style="list-style-type: none"> <li>○ OBE in AWIPSII with WES2 and archiver functionality in OB13.5.3</li> <li>○ WES2 archiver functionality currently only deployed at WFOs (not at RFCs or NC) thus no functionality loss.</li> </ul>
<b>VIR</b>	Only at SPCN & NHCN	<ul style="list-style-type: none"> <li>○ Provides failover functionality for serial connections from asyncMux out on PX servers (legacy NWWSUP functionality) as well as for LDAD serial connections.</li> <li>○ Only installed at SPCN and NHCN for the NWWSUP legacy CSC data stream.</li> </ul>
<b>Adtrans</b>	Not Commissioned	<ul style="list-style-type: none"> <li>○ Provides dial backup 56k telco line from ANCF to site if OPSnet goes down.</li> <li>○ NC use LDM out NCEP 140.90 network if AWIPS WAN drops to send out dbNet backup site. There availability on the AWIPS WAN is not operationally significant.</li> </ul>
<b>XT</b>	Not Commissioned	<ul style="list-style-type: none"> <li>○ Provided legacy text workstation dedicate functionality</li> <li>○ Can launch text workstation interface via CAVE or standalone in AWIPSII</li> </ul>
<b>DAS</b>	NAS2 device	<ul style="list-style-type: none"> <li>○ NetApp FAS3160-A is unified storage solution with functionality achieved by the WFO DAS and NAS.</li> <li>○ The file shares are served by the node NAS1 while the block storage is served by the node NAS2.</li> </ul>
<b>Modem Nest</b>	Installed but non-operational	<ul style="list-style-type: none"> <li>○ ROSA, ASOS and Co-Op dial-in lines for remote sensing collection.</li> <li>○ These devices are installed but there are no dial-in lines and not operational.</li> </ul>
<b>NAS</b>	NetApp FAS3160-A	<ul style="list-style-type: none"> <li>○ Provides the block and file level storage to the system but differs from WFO/RFC model.</li> </ul>
<b>LX</b>	HP Z800	<ul style="list-style-type: none"> <li>○ Baseline HP Z600 provides same functionality, same hardware, bit just smaller power-supply units.</li> </ul>
<b>HBA Cards</b>	8 per site, require only 4	<ul style="list-style-type: none"> <li>○ 8G HBA cards for block level fiber channel LC/LC optical access</li> <li>○ HP DL380 G7 servers only support 4.8G on BUS</li> </ul>
<b>DX3-6</b>	EDEX Processing Servers	<ul style="list-style-type: none"> <li>○ HP DL380 G6 servers with 12G of RAM.</li> <li>○ Provide additional members to EDEX SOA</li> </ul>
<b>Monitors</b>	Varies per NC	<ul style="list-style-type: none"> <li>○ 19" and 24" monitors installed</li> <li>○ 4 monitors, NC baseline, not WFO or RFC baseline</li> </ul>
<b>CPSBN</b>	12G RAM after DX1/2 Replacement	<ul style="list-style-type: none"> <li>○ Added for larger Qpid max memory</li> </ul>

## A2.3: NATIONAL CENTERS AWIPS CONFIGURATION

There is a delta configuration between a typical WFO and/or RFC and also there is such configuration between these offices and a NC. Moreover, each NC is unique in its configuration and external connections and customers. This section details the unique configurations present at each NC that compromises a NC baseline configuration for AWIPS.

### A2.3.1: Product Dissemination System (PDS)

The National Centers (NC) disseminates products via the PDS similarly to how WFOs and RFCs utilize the AWIPS Message Handling System (MHS). The difference is that the PDS runs on the NCEP WAN but has hooks into the AWIPS WAN via the firewall.

The PDS runs as an instance of the UniData LDM software on PX2. There is no high-availability of the PDS, that is, if PX2 is not operational, PX1 does not assume the LDM for the PDS.

LDM is not monitored nor considered during upgrades, restores, or normal processes, thus imperative to make it known to whomever prior to any baseline mod note or system changes. For issues related to the PDS, the NCs should contact NCO Help Desk not the NCF. The NCF may perform troubleshooting steps indicated below, however care should be given when rebooting or working on the PX servers at NCs and nothing should be rebooted without site approval first.

The configuration on the AWIPS firewall for the PDS at the NCWCP is as follows with IP addresses removed:

```
unset policy id 60
unset policy id 62
unset interface "ethernet0/2" mip xxx.xx.xx.xx

set interface "ethernet0/2" mip xxxxx host xxxxx netmask 255.255.255.255 vr "trust-vr"

set policy id 60 from "Untrust" to "Trust" "LDMHost" "MIP(xxxxx)" "LDM" nat src permit log count

set policy id 60

set policy id 62 from "Untrust" to "Trust" "Any" "MIP(xxxxxx)" "LDM" nat src permit log

set policy id 62
set policy move 60 after 2
set policy move 62 after 60
```

**To troubleshoot the PDS**, the following steps may be performed:

- (1) Ensure that the LDM software is running on PX2.

- (2) LDM runs as user ldm under /usr/local/ldm and is controlled similarly to the AWIPS SBN LDM software that runs on CPSBN1.
  - a. To stop|start the LDM software, as user ldm run `ldmadmin [stop|start]`
- (3) To check the connection through the firewall of LDM which connects via TCP port 388 from PX2 to the PDS destination address:
  - a. On the primary firewall run: `get log traffic policy 62`
  - b. Ensure that TCP FIN traffic is shown over port 388 for LDM protocol

### A2.3.2: NCEP Non-Satellite Broadcast Network (NSBN) Data Flow

The National Centers (NC) ingest data over the AWIPS SBN (aka NOAAport), via the typical WFO/RFC ingest paradigm, as well as via a terrestrial push mechanism across the NCEP Campus Network (COPC), which is external to the AWIPS Wide Area Network (WAN). This method of ingest is similar to how WFOs and RFCs obtain “local model data” from their Regional network.

The terrestrial push mechanism utilized is DBnet and/or a simple *scp*, DBnet is a distributed data communications and processing system similar in function to the AWIPS MHS or the UniData LDM/readNOAAport processes. The DBnet servers at the NCs run external-to-AWIPS and on the NCEP Campus Network at each site. The data sent to these servers is pushed directly from the Center for Centralized Computing Services (CCS) and the NCEP Central Operation servers (NCOSRV). The point-of-presence for the NCEP Campus Network to AWIPS is the LDAD LAN Switch (device name: LLSW).

In order for data from the NCEP Campus Network to be sent to AWIPS for ingest and processing via the LLSW it must traverse the AWIPS firewall and be processed by the rulesets & routing enforced therein.

Once the data is moved over to the AWIPS network via the AWIPS firewall, it is further processed on the Communications Processors for the Satellite Broadcast Network (CPSBN) devices and finally injected into EDEX via the AWPDBNET scripts for decoding and storage via the same mechanisms for AWIPS SBN ingest.

The AWPDBNET scripts run on the CPSBN2f physical server. The CPSBN2f is controlled by a2cp2apps resource group and the IPADDR resource of the high-availability software suite HA. The AWPDBNET scripts are also controlled as part of the a2cp2apps resource group application /home/awpdbnet/bin/nsbn\_ingest.

## National NSBN Data Flow Diagram:

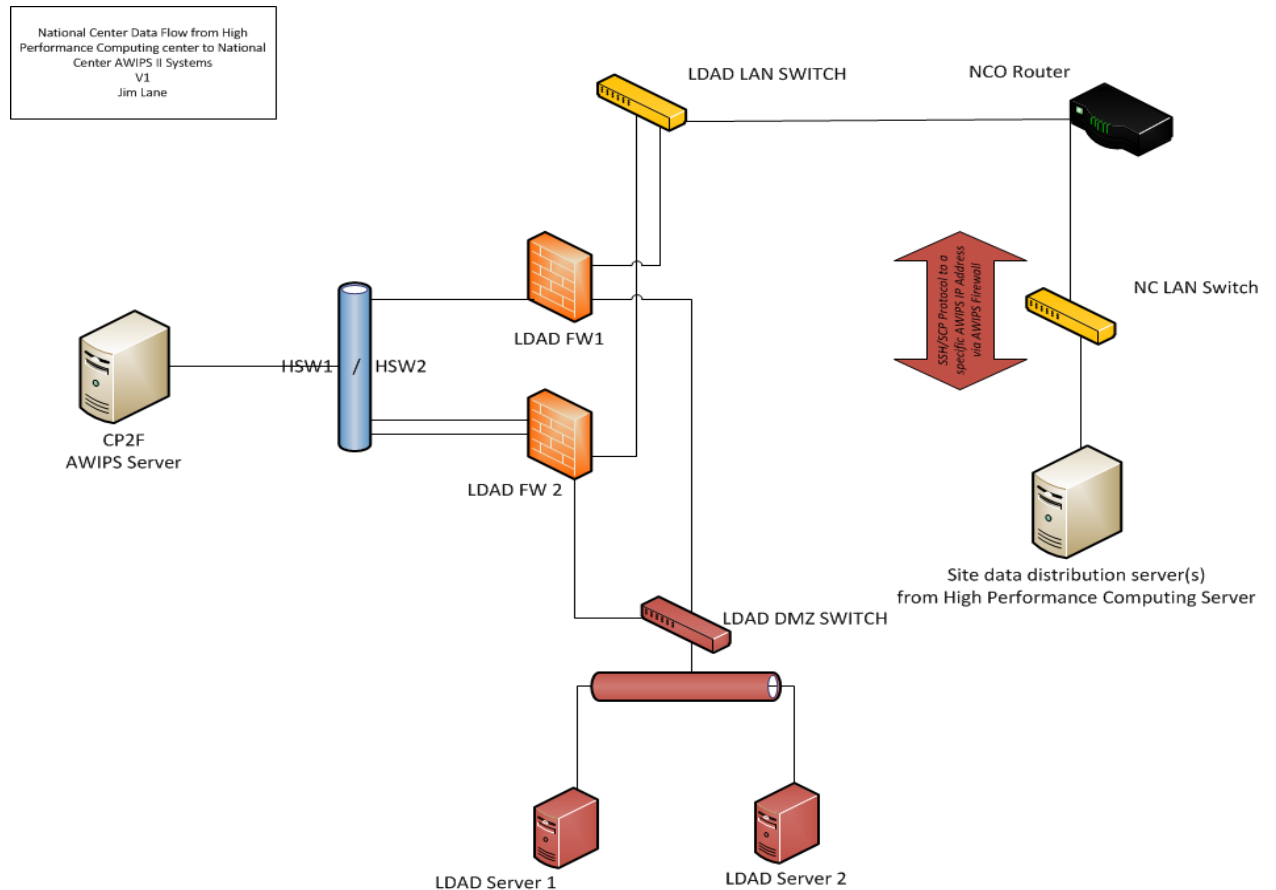

Device connections between NCEP network source and AWIPS destination (cpsbn2f):

- **LLSW:** The LDAD LAN Switch which can be accessed only via the LS1 device through a telnet session. This is a simple layer 2 switch without any access controls, redundancy, or filters in place. It acts similarly to a shared media hub and broadcasts across all ports.
  - **ssh ls1; telnet lts**
  - Login: **root** // password: **<xxxxxxxx>**
  - Login to the LLSW via the **ts\_menu** connection TUI
  - The only troubleshooting step for the LLSW is to reboot the device locally at the office by having site staff unplug and plug back in the power supply.
  - Another option is to move the connections to different ports on the LLSW if a port is suspect to be the cause of connectivity issues. All ports are configured identically.
- **LDAD FW:** The LDAD firewall device is a layer 3 switch with access controls and virtual routing. This device translates packets destination addresses and maps them to the correct internal-to-AWIPS address for delivery to the cpsbn2f. This



device is redundant and may be failed over via rebooting the main or active firewall.

- **HSW1/HSW2:** The AWIPS high-speed LAN switches are layer 2 devices that provide site LAN connectivity. These devices are configured in a RSTP configuration and can only be accessed by the AWIPS communications staff.
- **CP2F:** The CPSBN2 floater IPADDR is the virtual address for the a2cp2apps resource group and runs on the physical device actively hosting the resource.

The NSBN data flow components in more detail, with the NCEP network indicated by the “EXTERNAL LAN/WAN” cloud on the far right side with the POP into AWIPS being the LLSW.

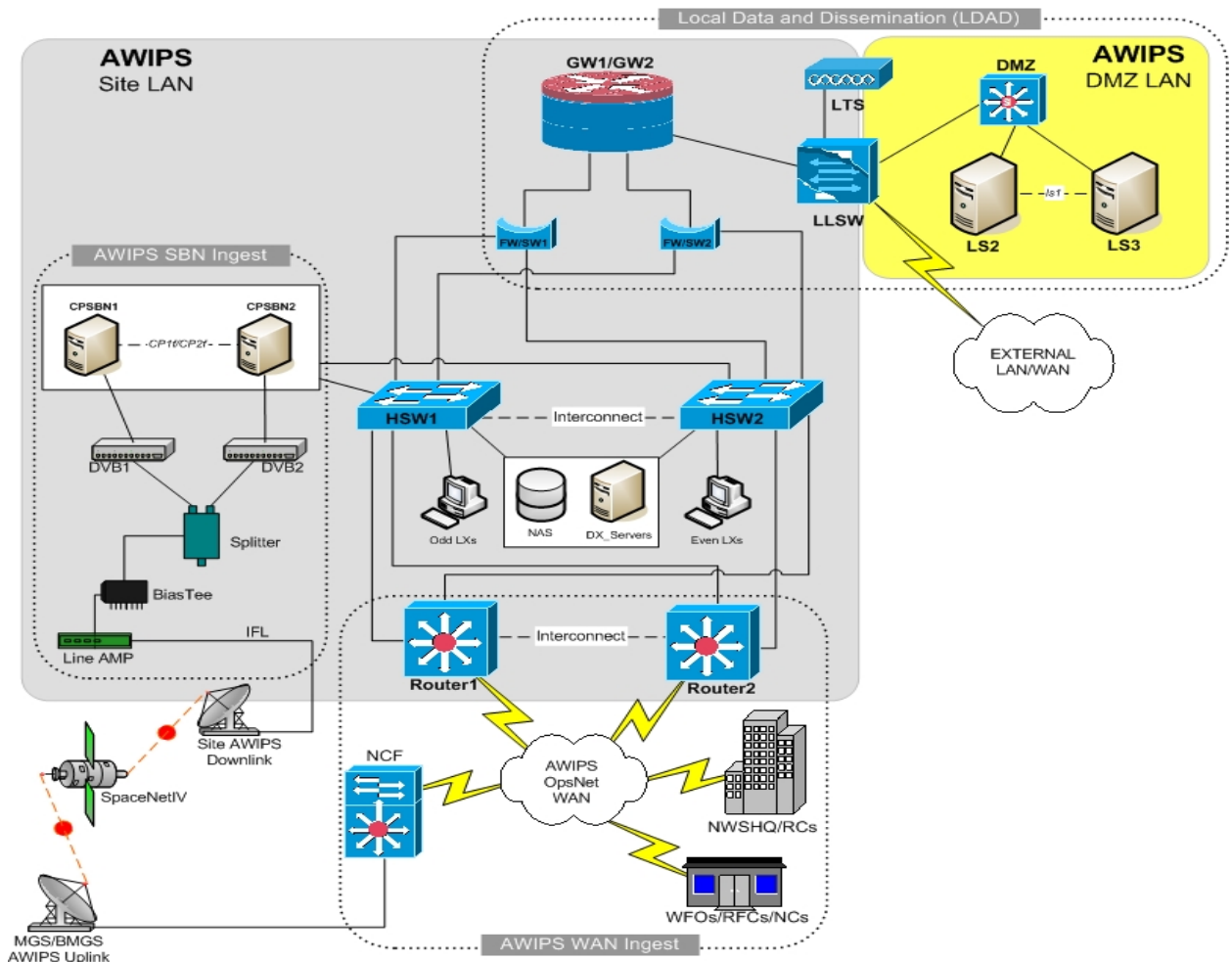

Further expanded detail on the NCEP network (right half) and the hops therein are showed below. The connections in the dark gray shaded regions are NCEP-NCO responsibility; the sections in the lighter gray are AWIPS'.

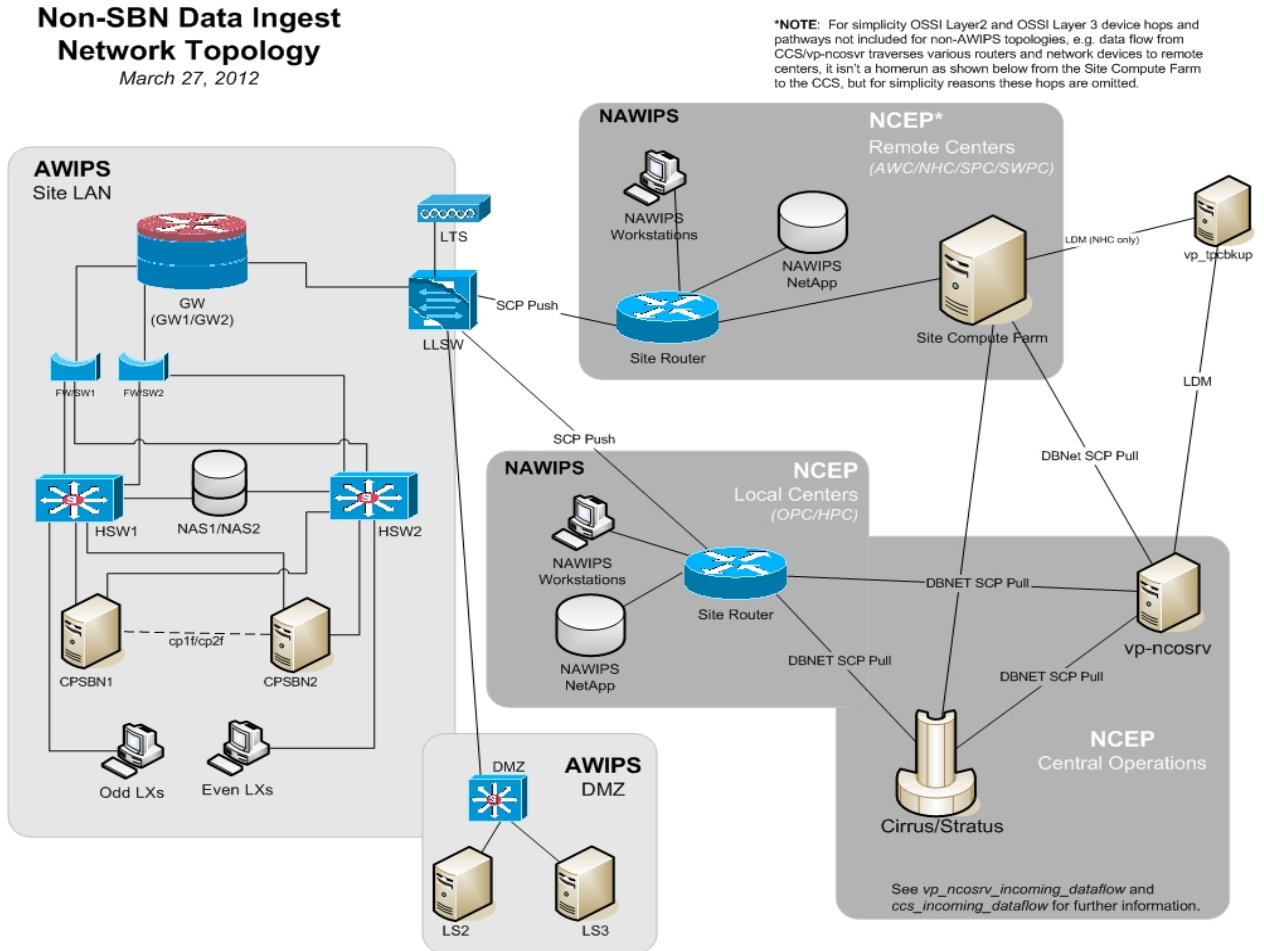

### A2.3.3: NSBN Data Network Interfaces

This section details the devices and network interfaces a packet will traverse when it arrives to the AWIPS POP and travels through to the destination CPSBN2f for handoff to the NSBN ingest scripts.

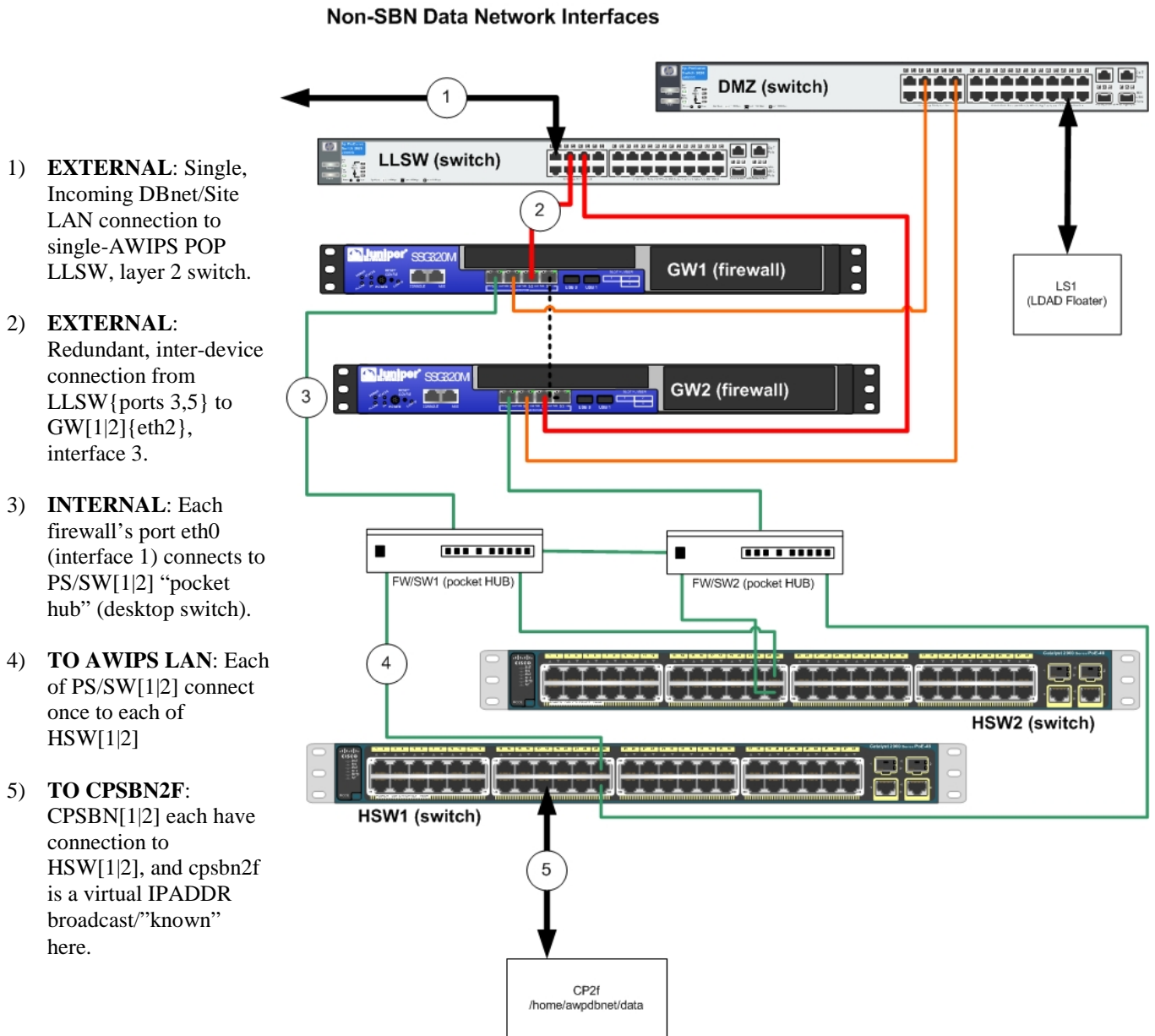

Device	Functionality
<b>LLSW</b> Local LAN Switch <i>llsw-ccc</i>	<ul style="list-style-type: none"> <li>• POP for “Local non-AWIPS network”</li> <li>• Pure layer 2 (no modification to data or packet)</li> <li>• No redundancy</li> </ul>
<b>GW*</b> AWIPS Firewall <i>gw1-ccc (M)</i> <i>gw2-ccc (B)</i>	<ul style="list-style-type: none"> <li>• Provide SRC/DST routing and ACLs/ACEs to packets.</li> <li>• GW1 is floater for active firewall, GW2 is non-active firewall</li> <li>• Hardware &amp; software redundancy</li> </ul>
<b>PS/SW</b> Pocket Switch <i>ps/sw1-ccc</i> <i>ps/sw2-ccc</i>	<ul style="list-style-type: none"> <li>• Similar to a network bridge, but solely due to lack of ports on firewall</li> <li>• Provides redundancy to both HSW for firewall access.</li> <li>• Hardware redundancy</li> </ul>
<b>HSW*</b> AWIPS High-Speed Switch <i>hsw1-ccc</i> <i>hsw2-ccc</i>	<ul style="list-style-type: none"> <li>• Layer 2, RSTP enabled, GB switches, provide site AWIPS LAN networking</li> <li>• Hardware redundancy, except for connectivity of workstations</li> </ul>

**LDAD LAN Switch**

```
[root@dx1-opcn ~]# ssh ls1
[root@ls2-opcn ~]# ssh ltserver
{enter password for root user}
[root@lts-opcn root]#
```

From the factory, this device is configured as follows:

- Root/admin user have single, same passwd
- All serial ports are disabled.
- DHCP, Telnet, SSHv1, SSHv2, HTTP and HTTPS are all enabled.

- All external communications traverse the LLSW (not just the NSBN data feed)
- Use traceroute or login directly (NCF only) to verify connectivity
- Power-cycle, or reseal network cables if issues are isolated to LLSW
- Most likely issue is with site-external network drop (black line in picture above)

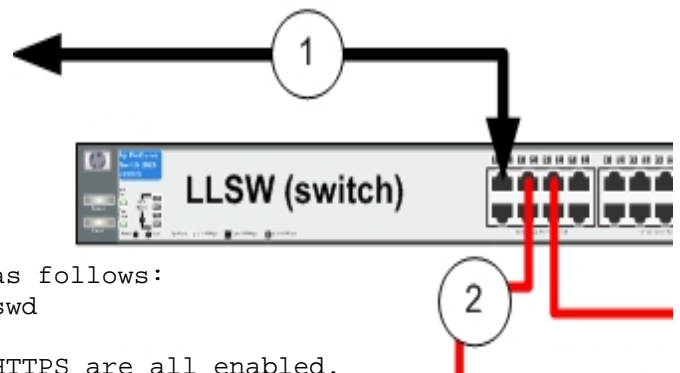

```
[root@ls2-opcn ~]# traceroute -T -p 22 xxx.xx.xx.x
traceroute to xxx.xx.xx.x (xxx.xx.xx.x), 30 hops max, 40 byte packets
 1  gw-opcn (xxx.xxx.x.x)  0.194 ms  0.273 ms  0.273 ms
 2  xx.xx.xx.x (xx.xx.xx.x)  2.135 ms  2.140 ms  2.134 ms
 3  xxx.xx.xx.x (xxx.xx.xx.x)  0.807 ms  0.803 ms  0.808 ms
```

## AWIPS Firewall

**CONVENTIONS:**

CCCC = AWIPS Site node name  
 140.90.YY.YY = external IPADDR on the site NCEP campus network to which data and/or traffic is destin

140.90.ZZ.ZZ = external IPADDR on the site NCEP campus network from which data originates

`\${hostname}` = a variable that is specific to a site or device referenced

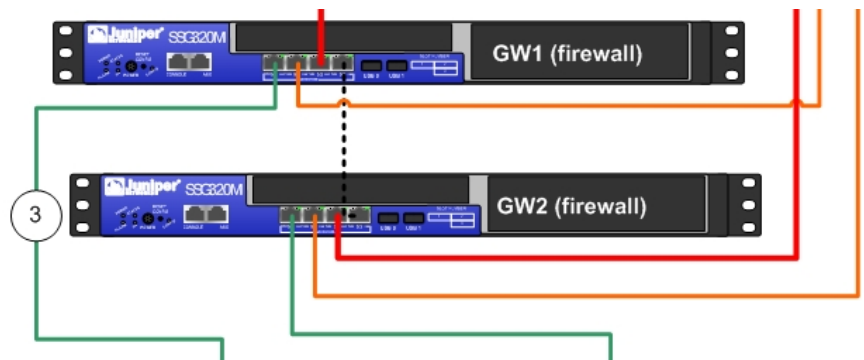

Firewall configuration and the functionality it provides. This configuration is specific to the NCWCP facility, however the policies and commands are saved into the running configuration at all NCEP AWIPS firewalls with the specific addresses for each installation.

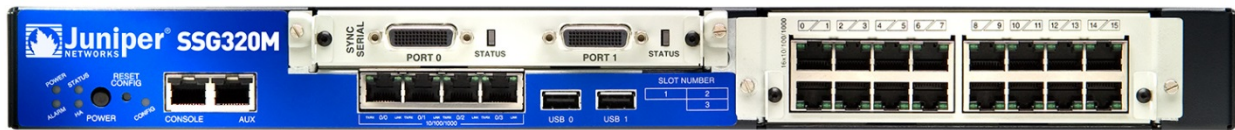

```
gwl-opcn(M)-> get interface
```

A - Active, I - Inactive, U - Up, D - Down, R - Ready  
 Interfaces in vsys Root:

Name	IP Address	Zone	MAC	VLAN	State	VSD
eth0/0	xxx.xx.XX.XXX/25	Trust	0010.dbff.2000	-	U	0
eth0/1	xxx.xxx.x.x/24	DMZ	0010.dbff.2050	-	U	0
eth0/2	xx.xx.XX.XX/24	Untrust	0010.dbff.2060	-	U	0
eth0/3	0.0.0.0/0	HA	0026.88e3.b607	-	D	-
vlan1	0.0.0.0/0	VLAN	0010.dbff.20f0	1	D	0
null	0.0.0.0/0	Null	N/A	-	U	0

- **eth0/0** is internal (site AWIPS LAN) IPADDR of the firewall – this is the GW for access to the LDAD (DMZ) or external communications
- **eth0/1** is the DMZ IPADDR – this is the GW for access out from the DMZ (LDAD)
- **eth0/2** is the “external LDAD IPADDR” or the external interface to non-AWIPS communications (e.g. NSBN, NCLADT wiki, etc...)

Set of **useful commands** to determine the configuration and policy on the AWIPS firewalls:

```
gw1-opcn(M)-> get policy id 77
name:"none" (id 77), zone Untrust -> Trust,action Permit, status "enabled"
src "LOCAL NCWCP", dst "MIP(10.90.XX.XX)", serv "SSH"

gw1-opcn(M)-> get address | include NCWCP
xx.xx.xx.x/NCWCP      xx.xx.xx.x/255.255.255.0      0201
LOCAL NCWCP          15 v4                                     User-defined

gw1-opcn(M)-> get address Trust | include cp2f
cp2f-opcn            xxx.xx.xx.xx/255.255.255.255      0200

gw1-opcn(M)-> get address | include 10.90.XX.XX
MIP(xx.xx.xx.xx)    xx.xx.xx.xx/255.255.255.255      0210 ethernet0/2
```

- Mapped IPADDR on firewall traverse the trust virtual router which allows communications from extranet to intranet (AWIPS).
- These policy rules should never change if they are absent, indicates firewall was reset back to factory defaults.
- If IPADDR of local device copying NSBN data to AWIPS changes, CONTACT THE NCF & NCO WELL (months) BEFORE THE CHANGE OCCURS. Otherwise all NSBN data will cease when the IPADDR is changed.

Troubleshooting the firewall and networking therein:

- (1) Determine if traffic is passing through the firewall under the policies identified for the NSBN data flow via **get log traffic policy 77** and look for TCP FIN closed messages. This indicates that the SCP is completing through the firewall and the firewall is most likely not the cause of the issue.
- (2) Trace the route from the firewall to the source IPADDR for the scp and determine if it can connect out through the NCEP gateway. If it makes it out to the 10.90 network than the firewall and the LLSW are not the cause of the issues.

The command below shows troubleshooting step (1) in that the TCP FIN messages are being received.

```
get log traffic policy 77
```

The command below shows troubleshooting step (2) in that the trace-route hits the source address.

```
trace-route xxx.xx.x.xx
Type escape sequence to escape
```

Firewall status lights:



- On both firewalls the **Status 1** should be blinking **green**
- On the primary firewall the **Status 2** should be steady **green**
- On the secondary firewall the **Status 2** should be steady **amber**

**NOTE:** the pinhole in this photo is the reset button. Pressing this will set the firewall back to the factory default, which will not allow any traffic from anywhere to anywhere! You will lose all firewall rules! This is NOT the same as the Xyplex reset!

**FW/SW Pocket Hubs**

**REMEMBER:**  
National Centers have a GB FW/SW desktop switch.  
DO NOT ORDER ONE FROM NLSC  
Contact NCO if the FW/SW fails,  
after opening ticket with NCF.

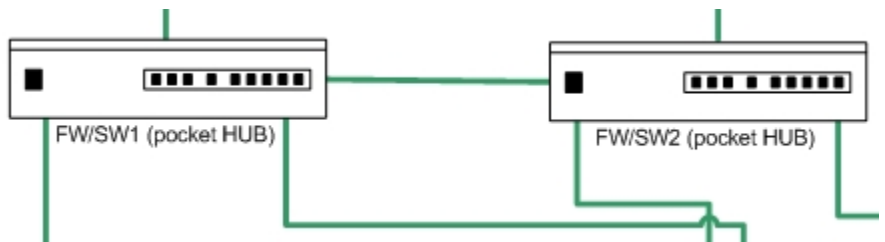

- These are simple “desktop switches” similar to network bridges.
- Power cycling the devices is the only troubleshooting technique.
- Should the least-cost path in RSTP fail, then the FW/SW is the next least cost. If this occurs, all network traffic typically slows on site local AWIPS LAN, however NC FW/SW are GB and slow-downs will occur although not as severe.

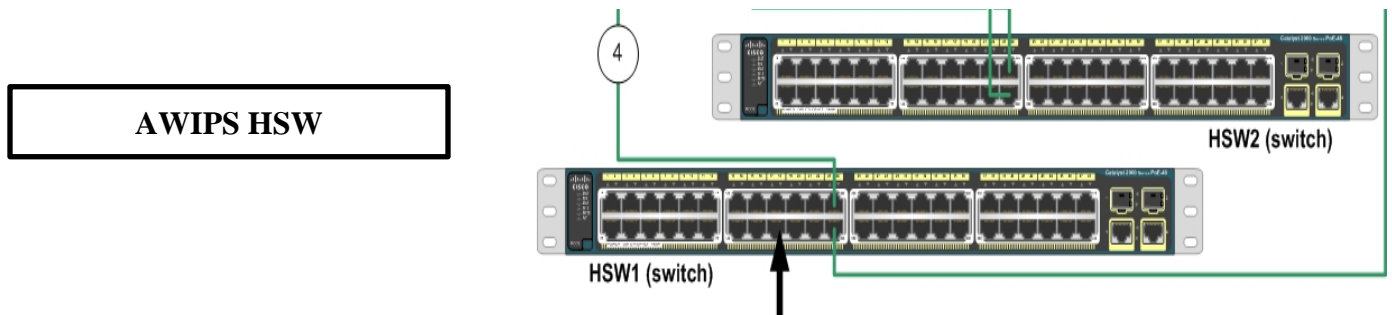

- Ports 20 and 21 on HSW1 and HSW2 are FW/SW path to the firewall.
- These lights should be green, and indicate GB networking.
  - Indication of 10/100 will slow down transfer of NSBN data.
- If FW/SW, or HSW suspected of causing issues, contact the NCF ISG, sites cannot login to the HSW.
- Workstations do not share connections to both HSWs, all other devices do.
- CPSBN2f is a virtual interface on bond0, thus it shares connections to both switches.



#### A2.3.4: NSBN Ingest

NAWIPS is used in operations at the National Centers. The data used in NAWIPS comes from a variety of sources not associated with the Satellite Broadcast Network (SBN) used by AWIPS. This data needs to be available for the NC forecasters on the AWIPS system. To accomplish this, the Non-SBN (NSBN) data flow was created. The data files are passed through the firewall to the CPSBN AWIPS server running the cpsbn2f “floater” virtual IP address. Under normal configurations (i.e. non-failover) cpsbn2 runs the cpsbn2f floater. See previous sections for more information on the data flow and network topology of the NSBN data.

The following types of data are sent to CP2F from servers on the NCEP side of the firewall, including the WCOSS supercomputer.

- McIDAS satellite images
- Radar mosaic images
- Scatterometer winds
- Significant Wave Height values
- Model files not available on the SBN
- NTRANS metafiles
- ATCF tropical cyclone forecast files
- Legacy Vector Graphics Files from NAWIPS
- VIIRS images not available on the SBN

Note that for the NSBN data types, some may be duplicated over the SBN especially as it pertains to the gridded datasets, as the NSBN GRIB files are usually a superset of those uplinked over the AWIPS SBN. Others may appear to be duplicative but are actually complementary or differ in file format and spatial coverage. For example, the Radar Mosaic Images are in raster data format there are a national mosaic compiled by Unisys and using Unisys algorithms delivered to NCEP. The radar mosaic in AWIPS baselines uses display side code to overlay and mesh individual WSR-88D raster data and levels into mosaics allowing for a mosaic for any available WSR-88D product. The NSBN radar mosaic images only is for base reflectivity.

Starting with OB14.2.1 the NSBN ingest mechanisms and system engineering to support the NSBN dataflow is installed as baseline at all National Centers. While each NC will have a different source and subset of NSBN data ingesting, all NCs will use the internal CPSBN2f as the destination and the same system configuration on AWIPS.

### A2.3.4.1: NSBN Environment

The following sections detail the setup, configuration, and runtime environment for the NSBN data ingest and relevant system engineering. Where appropriate, the commands to setup the particular aspect being discussed is provided; however, these commands are for reference only and should not be required to be ran assuming a NC has already installed OB14.2.1 and/or the setup was performed.

#### A2.3.4.1.1: NSBN User Account Configuration: *awpdbnet*

- ❑ An account to run the NSBN processing is configured as a *local user* on the CPSBN1 and CPSBN2 devices at NCs. The account is managed via the local name service files, i.e. `/etc/[passwd, shadow, group]` and not managed by the NIS/NIS+ configuration as are system-wide users on AWIPS. The NSBN user is **awpdbnet** and its primary group is also **awpdbnet**.

The commands to create the **awpdbnet** local user on CPSBN1 and CPSBN2:

```
echo "awpdbnet:x:2012:awpdbnet" >> /etc/group
echo "awpdbnet:x:2012:2012:NSBN User:/home/awpdbnet:/usr/bin/csh" >> /etc/passwd
```

- ❑ The user's home directory is `/home/awpdbnet` and this directory is mounted via Network File Sharing (NFS) protocol on the CPSBN1 and CPSBN2 devices from the Network Attached Storage (NAS) controller **NAS2** at each NC.
  - **NOTE:** The `/home/awpdbnet` NFS mount is currently the only NFS share exported from the **NAS2** controller at NCs. Typically the NAS2 controller was reserved for block-level storage exports however due to space limitations it is the storage backend for the *awpdbnet* users home.

The commands ran to create the **awpdbnet** user home directory on the NAS2 device and to export the share to all baseline servers and workstations in the `/etc/netgroup` file on the NAS2 are shown below.

```
snap sched -A aggr 0 0 0; aggr options aggr0 nosnap on; snap reserve -A aggr0 0
vol create dbnetDATA aggr0 1024g
vol options /vol/dbnetDATA nosnapdir on
vol options /vol/dbnetDATA nosnap on
snap reserve -V dbnetDATA 0
snap sched -V dbnetDATA 0 0 0
exportfs -io actual=/vol/dbnetDATA,sec=sys,rw,root=@SERVERS:@WORKSTATIONS, nosuid /dbnetDATA
exportfs -w /dbnetDATA; exportfs -w /etc/exports
```

- ❑ The export from the NAS2 is advertised to the CPSBN devices as `/dbnetDATA` and is persisted across reboots via an entry in the `/etc/fstab` file (only on CPSBN1 and CPSBN2).

The commands to create the **awpdbnet** mount point for the NAS2 exported home directory on the CPSBN1 and CPSBN2 devices are shown below.

```
echo "nas2:/dbnetDATA /home/awpdbnet nfs tcp,timeo=600,defaults" > /etc/fstab
cd /; mkdir -p /home/awpdbnet; chmod 000 /home/awpdbnet
mount -a
chown -R awpdbnet:awpdbnet /home/awpdbnet
chmod 774 /home/awpdbnet
```

- ❑ There is then a secondary NIS/NIS+ user account created in the NIS maps by adding the same entries for the user account creation on the CPSBN1 and CPSBN2 devices to the DX1 device. This is done so that when mounting directories that have files or ownerships by the *awpdbnet* user account, the mapping of the User ID (uid) and Group ID (gid) is done appropriately. The *awpdbnet* NIS user account has a home directory of `/home/awpdbnet` similar to the CPSBN1 and CPSBN2 local user, however the NFS share from the NAS2 is not mounted. Thus the *awpdbnet* user's home directory is under the default `/awipsHOME` NFS share exported from NAS1 under the `/vol/vol_awipsNFS` volume. Therefore, `/home/awpdbnet` directory on CPSBN1 and CPSBN2 will differ from the `/home/awpdbnet` directory on all other devices.
- ❑ Since the NSBN file copy mechanism through the AWIPS firewall as discussed previously uses the secure copy protocol (SCP) over secure shell protocol (SSH) passwordless SSH needs to be functional. There is **awpdbnet** specific SSH keys in the NAS2 exported `/home/awpdbnet` (only mounted on CPSBN1 and CPSBN2 devices) under `/home/awpdbnet/.ssh` that must be correct and match those accordingly to allow such passwordless SSH access on the source device (on the external to AWIPS, NCEP network).
  - **NOTE:** The maintenance and control of the awpdbnet user SSH keys on the CPSBN1 and CPSBN2 devices is the responsibility of the local NC and not under the auspices of the AWIPS program. Contact each local NC IT/Help Desk staff if keys are missing or there is an SSH access problem from the source of the NSBN data SCP to the CPSBN2f AWIPS physical destination server.
  - **NOTE:** The SSH keys for the co-located National Center for Weather and Climate Prediction (NCWCP) systems NTBN, HPCN, and OPCN are

identical. Therefore, should a problem arise at one or two of these centers and related to missing or incorrect SSH keys one could theoretically copy the **/home/awpdbnet/.ssh** directory from one of these systems on which the SCP is functioning properly to the non-functional system. However, if all three co-located NCWCP systems are having issues, this would not apply.

A listing of the SSH keys for the awpdbnet user on the CPSBN1 and CPSBN2 devices are shown below.

```
[root@cpsbn2-opcn /]# ls -ltr /home/awpdbnet/.ssh/
-rw-r--r-- 1 awpdbnet awpdbnet 402 May 18 2012 id_rsa.pub
-rw----- 1 awpdbnet awpdbnet 1675 May 18 2012 id_rsa
-rw-r--r-- 1 awpdbnet awpdbnet 418 Jun 21 2012 nawips1_id_rsa.pub
-rw-r--r-- 1 awpdbnet awpdbnet 2288 Apr 28 15:51 known_hosts
-rw----- 1 awpdbnet awpdbnet 4888 May 13 17:05 authorized_keys
```

#### A2.3.4.1.2: NSBN Raw Data Store: */nsbn\_store*

- ❑ Similar to the baseline */data\_store* location for the raw SBN data there is a raw NSBN storage located named */nsbn\_store* which is a NFS mounted export from the storage backend NAS1 device at each NC.
  - **NOTE:** Unlike the */home/awpdbnet* mount which differs in its backend storage location depending on which device is the client (i.e. CPSBN1 and CPSBN1 mount */home/awpdbnet* from NAS2:/dbnetDATA but all other devices on a NC local AWIPS LAN mount from NAS1:/awipsHOME) the */nsbn\_store* mounts from the same storage backend on all devices.

The commands ran to create the */nsbn\_store* NSBN raw data store on device NAS1 and to export the share to all baseline servers and workstations in the */etc/netgroup* file:

```

snap sched -A aggr 0 0 0; aggr options aggr0 nosnap on; snap reserve -A aggr0 0
vol size /vol/vol_awipsNFS -2048g
vol create dataNSBN aggr0 2048g
vol options /vol/dataNSBN nosnapdir on
vol options /vol/dataNSBN nosnap on
snap reserve -V dataNSBN 0
snap sched -V dataNSBN 0 0 0
exportfs -io actual=/vol/dataNSBN,sec=sys,rw,root=@SERVERS:@WORKSTATIONS,nosuid /dataNSBN
exportfs -w /dataNSBN; exportfs -w /etc/exports

```

- ❑ The */nsbn\_store* is mounted to all devices on the AWIPS LAN at NCs and while the directory, when mounted, is owned by *awpdbnet:awpdbnet* it retains global read-write-execute permissions as does the baseline */data\_store* directory.
  - **NOTE:** This mount in particular is the rationale behind the NIS user *awpdbnet* being added to the DX1 NIS maps even though only the CPSBN1 and CPSBN2 devices will have interaction with an external *awpdbnet* user. When */nsbn\_store* is traversed on devices other than the CPSBNs, a listing of the contents would not resolve the UID/GID of 2012:2012 to *awpdbnet* without the secondary NIS user creation.

The commands ran to mount the */nsbn\_store* NSBN raw data store on all devices:

```

echo "nas1:/dataNSBN /nsbn_store nfs tcp,timeo=600,defaults" > /etc/fstab
cd /; mkdir -p /nsbn_store; chmod 000 /nsbn_store
mount -a

```

#### A2.3.4.2: NSBN Software

The following details the software specific to the NSBN ingest mechanisms that runs under the environment detailed above. These scripts were created by NCEP Central Operations (NCO) Systems Integration Branch (SIB) and are maintained by them as well.

The run-time is supported by the AWIPS program, however changes or local configuration is the responsibility of each NC respectively. The NSBN Environment should be configured before any installation of scripts or configuration occurs on the NC systems.

##### A2.3.4.2.1: NSBN Scripts: *Installation & Overview*

- ❑ Similar to the LDM software package, which writes data and routes data from the AWIPS SBN, the *nsbn\_ingest* acts as the raw data ingest mechanism from the NSBN SCP from the external NCEP SCP.
- ❑ The NSBN ingest scripts are installed post OB14.2.1 into the **CPSBN: /home/awpdbnet** directory from an archive delivered by NCO SIB.
  - **NOTE:** Once the uncompressed archive of the installation scripts is sent to the **/home/awpdbnet** directory, there exists a script named **fresh\_install.sh** that will also perform the steps listed in the outline below creating the necessary directory structure.

Instructions on installing the NSBN ingest scripts from an archive which should reside on NCs in the NFS mount **/data/fxa/INSTALL/nsbn\_install/14.2.1-postInstall-NSBN/nsbn.tar.gz**:

```
cd /; tar -C /home/awpdbnet -xzvf /data/fxa/INSTALL/nsbn_install/14.2.1-postInstall-NSBN/nsbn.tar.gz
cd /home/awpdbnet; mkdir archive logs data
cd archive; mkdir archive_viirs archive_misc archive_rad archive_ntrans archive_sat archive_grib archive_pgen
cd ../data; mkdir viirs_ingest misc_ingest rad_ingest ntrans_ingest sat_ingest grib_ingest pgen_ingest
cd /; chown -R awpdbnet:awpdbnet /home/awpdbnet /nsbn_store
```

- ❑ To achieve high-availability of the NSBN ingest the heartbeat resource group **a2cp2apps** is created along with the required configurations to allow automatic failover of the ingest scripts from CPSBN2 (primary server) to CPSBN1 (backup server) should there be a hardware or communications issue detected by the watchdog software associated with the baseline RedHat HA software installed.
- ❑ The **a2cp2apps** at Regional Centers contains the **Data Delivery Environment** setup and configuration to connect to NOMADS OPeNDAP

server for request and ingest of non-SBN delivered gridded datasets. The National Centers however don't require this methodology, thus while there is an a2cp2apps that does control ingest of non-SBN delivered datasets, the NCs does not involve baseline delivered software like that at the Regional Centers. Thus, do not confuse the functionality of the a2cp2apps at RCs with that at NCs. While the end result may be the same, the methodology and processes used to achieve that are wildly different.

Instructions on installing the NSBN HA software and configuration from files which should reside on NCs in the NFS mount `/data/fxa/INSTALL/nsbn_install/14.2.1-postInstall-NSBN`:

```
cd /data/fxa/INSTALL/nsbn_install/14.2.1-postInstall-NSBN
cp a2cp2apps /etc/ha.d/resource.d
cp a2SITEcp2cron /etc/ha.d/cron.d
cp nsbn_address.txt /etc/ha.d
scp /etc/ha.d/nsbn_address.txt cpsbn1:/etc/ha.d
scp /etc/ha.d/resource.d/a2cp2apps cpsbn1:/etc/ha.d/resource.d
scp /etc/ha.d/cron.d/a2SITEcp2cron cpsbn1:/etc/ha.d/cron.d
hb_run a2cp2apps
```

At this point, the NSBN hardware and networking configuration which was already installed at the NCs previously coupled with the NSBN software installation and activation detailed in this section should enable the ingest of the NSBN data stream into the local AWIPS office.

There are still optimization steps that are required to take place to ensure the level and frequency of datasets don't overwhelm the baseline configuration which are done as a post-install to OB14.2.1 and baselined in OB14.3.1 and upstream. Those optimization steps are detailed in the following sub-section, **A2.3.4.3: NSBN Optimization.**

#### A2.3.4.2.2: NSBN Scripts: Environment

The standard structure in the awpdbnet home directory contains the following directories:

- *archive*: location of the data after it has been processed, the archive keeps files for 1 day:
  - *archive\_grib*
  - *archive\_misc*
  - *archive\_ntrans*

- *archive\_pgen*
- *archive\_rad*
- *archive\_sat*
- *archive\_viirs*
- *bin*: all of the scripts to process the NSBN data
- *data*: ingest location, the NCEP side processing will drop files into the ingest directories, that is, the secure file-copy from the local NCEP network or WCOSS
  - *grib\_ingest*
  - *misc\_ingest*
  - *ntrans\_ingest*
  - *pgen\_ingest*
  - *rad\_ingest*
  - *sat\_ingest*
  - *viirs\_ingest*
- *etc*: configuration and runtime control files
- *logs*: output logs from the NSBN scripts

The data files are also written to the /nsbn\_store for use by QPID and EDEX ingest mechanisms.

Files in **/home/awpdbnet/bin** include:

- **nsbn\_ingest**  
This script takes care of starting and stopping the NSBN data flow. The services associated with each data type are listed in the configuration file nsbnServiceList.

Entering the script name without any arguments results in a usage statement:

Usage: **nsbn\_ingest** {**start**|**stop**|**restart**|**status**|**archive**}  
{**service**} {**service**}

If service(s) are blank, the script will start the default services

- **start** -- This command will start any services that are not running. A warning is generated if the service is already running. A service is comprised of a wrapper script and a Perl script. The wrapper ensures that the Perl script is always running
- **stop** -- This command will stop any running services. A warning is generated if the service is not running. Both the wrapper and the Perl scripts are



terminated.

- **restart** -- This command will stop then start the services.
- **status** -- This command will list the services. It will show the PID for the wrapper script and the Perl processing script for each service.
- **archive** -- This command will stop then start the services in archive-only mode. This means that the data files will be copied to the archive directory, but will not be sent to QPID for further processing.
- **nsbn\_run.sh**

This is the wrapper shell script that watches the Perl script to ensure that it is always running.
- **nsbn\_proc.pl**

This is the Perl daemon script that monitors the appropriate ingest directory for new files. As the files arrive they are passed to the processing script. The script spawns a number of threads to allow timely processing of the new files.
- **nsbn\_post.sh**

The processing script will set the appropriate identifiers for the data type and take actions on the files. It checks for the existence of an “include” table. If the table exists, data files that match the regular expression patterns in the table will be processed. All other files will only be archived. Next, the script checks for the existence of an “exclude” table. Any matches found in this table will only be archived and not processed further. If the data file is to be processed, the file is copied to /nsbn\_store and a message is sent to QPID. Finally, the file is always moved to the archive directory.
- **qpidNotify, setup.env and the “src” Directory**

qpidNotify and setup.env are shell wrappers to the Python scripts found in the src directory. The Python scripts call QPID to place a message in a queue based on the data type.
- **nsbn\_cycle\_logs.sh and newlog**

newlog has been borrowed from the LDM to cycle the logs and keep a specified number of each. The script nsbn\_cycle\_logs.sh is a script that may be invoked from the cron. It specifies the log that should be rotated and how many history logs to keep for each.
- **scour**

The scour script has also be borrowed from the LDM. It will purge files from the given directory which are older than the number of days specified in the configuration file.

- **PID files**

While the system is running, files that contain the process ID (PID) for the wrapper shell script are stored in the bin directory for use in getting the status or stopping the processes.

Files in **/home/awpdbnet/etc** include:

- **nsbnServiceList** -- This configuration file specifies the list of data types/services that will run by default.
- **include\_\*** -- Each data type can have an include table. If the file is present, data files that match any of the regular expression patterns in the file will be processed. All other data files will only be archived.
- **exclude\_\*** -- Data files that match regular expressions in the appropriate exclude table will only be archived and not processed.
- **crontab.txt** -- This file contains the required crontab entries to clean up the archive directory and /nsbn\_store. There is also an entry for rotating the logs.
- **scour.conf and scrub.conf** -- These configuration files are used by the scour script to identify the directories and number of days to keep the files. scour.conf is used to clean up /nsbn\_store and scrub.conf is used to clean up the archive directory.

### A2.3.4.3: NSBN Optimization

The following sections details the steps performed as a post-OB14.2.1 script to improve the memory management and data transfer rates between components of the baseline AWIPS system architecture for the added data flow from the NSBN feed into NCs. After these are baselined, the steps are not required post installation however until that time they should be performed or at a minimum verified to still be implemented post any OB release update at NCs running an AWIPS release upstream of OB14.2.1.

#### A2.3.4.3.1: EDEX Processing Server Changes: JAVA Heap Space

Since NCs do not run the **ingestDAT** Java Virtual Machine (JVM) on the EDEX Processing Servers there is less system memory utilization by the AWIPS software than at a typical WFO or RFC. Additionally, there are also two more physical servers added to the cluster (DX5 and DX6).

Due to these factors, **the JVMs maximum memory allocable for heap usage is increased on the three running JVMs** (ingest, ingestGrib, and request) to better account for the added NSBN data stream as well as the larger GFE domains for those NCs which run GFE (OPCN's GFE domains ONA and ONP; NHCN's GFE domains NH1 and NH2 – with NHCN's experimental Storm Surge GFE domain NHA).

The request, ingest, and ingestGrib JVM maximum heap memory allocable is defined in `/awips2/edex/etc/${JVM_NAME}.sh` where the changes made are as follows, indicating just the MAX\_MEM values inside the scripts.

- **NOTE:** The `/awips2` directory is a local partition unique to each EDEX Processing Server. The JVM startup environment scripts in `/awips2/edex/etc` must be changed on each DX3-DX6.

```
cd /awips2/edex/etc
  request.sh
  export MAX_MEM=2048 # in Meg

  ingest.sh
  export MAX_MEM=2048 # in Meg

  ingestGrib.sh
  export MAX_MEM=4096 # in Meg
```

To determine whether the changes to the JVM environment have taken (after a restart of the JVM), check the JVM startup log and search for **max\_mem**:

```
cd /awips2/edex/logs  
[root@dx3-opcn logs]# grep -i max_mem start-edex-ingestGrib-20140619.log  
bsd env MAX_MEM=4096
```

## Attachment A: NSBN Initial Installation

Perform these steps *only after updating the baseline software to 14.2.1* with the latest delta or incremental updates. Until these changes are base-lined, they will be required on all NCEP systems post-14.2.1 installation. Some updates and deltas will not update files previously changed; therefore, some edits may already exist.

- This can be done once CPSBN1 & CPSBN2 have been rebooted into 64-bit on RedHat Enterprise Linux 6.4 after 14.1.1 but before 14.2.1 AWIPS software is installed.
- This will remove all previous NSBN installations and configuration.

### 1. Copy the NSBN installation archive to the site.

```
scp -rp as4-ancf:/home/BradS/nsbn_install \
dx1-${SITE_IDENTIFIER}:/data/fxa/INSTALL
```

### 2. Create the NAS partitions for the NSBN raw data storage, nas1:/dataNSBN which is mounted to /nsbn\_store on the servers and workstations.

#### a. On nas1-\${SITE\_IDENTIFIER} or via ssh -qn nas1, run:

```
snap sched -A aggr 0 0 0; aggr options aggr0 nosnap
on; snap reserve -A aggr0 0

vol size /vol/vol_awipsNFS -2048g

vol create dataNSBN aggr0 2048g

vol options /vol/dataNSBN nosnapdir on

vol options /vol/dataNSBN nosnap on

snap reserve -V dataNSBN 0

snap sched -V dataNSBN 0 0 0

exportfs -io
actual=/vol/dataNSBN,sec=sys,rw,root=@SERVERS:@WORKSTA
TIONS, \ nosuid /dataNSBN

exportfs -w /dataNSBN; exportfs -w /etc/exports
```

**b. On all clients (DX servers, PX servers, CP servers, workstations):**

```
echo "nas1:/dataNSBN      /nsbn_store      nfs
    tcp,timeo=600,defaults" > /etc/fstab

cd /; mkdir -p /nsbn_store; chmod 000 /nsbn_store

mount -a
```

**3. Create the /home/awpdbnet mount on the NAS as /dbnetDATA****a. On nas2- $\{\text{SITE\_IDENTIFIER}\}$  or via ssh `-qn nas1`, run:**

```
snap sched -A aggr 0 0 0; aggr options aggr0 nosnap
on; snap reserve -A aggr0 0

vol create dbnetDATA aggr0 1024g

vol options /vol/dbnetDATA nosnapdir on

vol options /vol/dbnetDATA nosnap on

snap reserve -V dbnetDATA 0

snap sched -V dbnetDATA 0 0 0

exportfs -io
actual=/vol/dbnetDATA,sec=sys,rw,root=@SERVERS:@WORKST
ATIONS, \ nosuid /dbnetDATA

exportfs -w /dbnetDATA; exportfs -w /etc/exports
```

**b. On cpsbn1 and cpsbn2:**

```
echo "nas1:/dbnetDATA    /home/awpdbnet  nfs
    tcp,timeo=600,defaults" > /etc/fstab

cd /; mkdir -p /home/awpdbnet; chmod 000
/home/awpdbnet

mount -a
```

**4. Create the awpdbnet user and user information****a. On DX1 and DX2 as user root:**

```
echo "awpdbnet:x:2012:awpdbnet" >> /etc/group

echo "awpdbnet:x:2012:2012:NSBN
User:/home/awpdbnet:/usr/bin/csh" >> /etc/passwd
```

**b. On DX1 as user root:**

```
/var/yp/ypmake
```

**c. On CPSBN1 and CPSBN2 root:**

```
echo "awpdbnet:x:2012:awpdbnet" >> /etc/group

echo "awpdbnet:x:2012:2012:NSBN
User:/home/awpdbnet:/usr/bin/csh" >> /etc/passwd

chown -R awpdbnet:awpdbnet /home/awpdbnet

chmod 774 /home/awpdbnet
```

**5. Install the NSBN scripts**

**a. On CPSBN2 as user root:**

```
cd /; tar -C /home/awpdbnet -xzvf
/data/fxa/INSTALL/nsbn_install/14.2.1-postInstall-
NSBN/nsbn.tar.gz

cd /home/awpdbnet; mkdir archive logs data

cd archive; mkdir archive_viirs archive_misc
archive_rad archive_ntrans archive_sat archive_grib
archive_pgen

cd ../data; mkdir viirs_ingest misc_ingest rad_ingest
ntrans_ingest sat_ingest grib_ingest pgen_ingest

cd /; chown -R awpdbnet:awpdbnet /home/awpdbnet
/nsbn_store
```

**6. Install the heartbeat packages**

**a. On CPSBN2 as user root:**

```
cd /data/fxa/INSTALL/nsbn_install/14.2.1-postInstall-
NSBN

cp a2cp2apps /etc/ha.d/resource.d

cp a2SITEcp2cron /etc/ha.d/cron.d

cp nsbn_address.txt /etc/ha.d

scp /etc/ha.d/nsbn_address.txt cpsbn1:/etc/ha.d

scp /etc/ha.d/resource.d/a2cp2apps
cpsbn1:/etc/ha.d/resource.d

scp /etc/ha.d/cron.d/a2SITEcp2cron
cpsbn1:/etc/ha.d/cron.d

hb_run a2cp2apps
```

## 7. Post-install steps

### a. On CPSBN1/2 as user root set password for user *awpdbnet*:

```
passwd awpdbnet
```

### b. CPSBN1/2 as user root update SSH key for *awpdbnet* to allow passwordless SSH:

```
/home/awpdbnet/.ssh/id_[dsa,rsa].pub
```

### c. Change NAS quotas, from DX1:

```
mount nas1:/vol/vol0 /media
```

```
vim /media/etc/quotas
```

- Change awipsSTORAGE to 300G

```
cd /; umount /media
```

```
ssh nas1 "quota off vol_awipsNFS"; sleep 3; ssh nas1
"quota on vol_awipsNFS"
```



## Attachment B: NCF Standard Operating Procedures (SOPs)

These SOPs are valid during the pre-FOTE and FOTE stages of the NAWIPS-AWIPS migration at the RCs and NCWCP centers. These are for problems identified by *site*, *NCO-SDM*, or *external agency* indicating possible issue with data availability.

NCF shall follow these procedures by the letter and numbered lists in sequential order for all issues.

1. Affected-site's Senior Branch Forecaster (SBF) or SDM will contact the affected-center's Technical Support Branch (TSB) to inform them of the issue and impact to operations.

SDM Desk: [sdm@noaa.gov](mailto:sdm@noaa.gov) | Ph: 301-683-1500

OPC Ops: [ncep.list.opc@noaa.gov](mailto:ncep.list.opc@noaa.gov) | Ph: 301-683-1520 (Senior Branch Forecaster)

OPCN TSB: [ncep.list.opc-support@noaa.gov](mailto:ncep.list.opc-support@noaa.gov)

HPC Ops: [ncep.wpc@noaa.gov](mailto:ncep.wpc@noaa.gov) | Ph: 301-683-1530 (Senior Branch Forecaster)

HPCN TSB: [ncep.list.wpc-dtb@noaa.gov](mailto:ncep.list.wpc-dtb@noaa.gov)

2. The affected-center's TSB will make the determination if the problem is local and contact the SDM to report whether local remediation was possible.
3. The SDM will make the decision to contact the Product Management Branch (PMB) Data Flow Team (email: [ncep.list.pmb-dataflow@noaa.gov](mailto:ncep.list.pmb-dataflow@noaa.gov)) based on the report from the affected-center's TSB and outcome of any local troubleshooting efforts or contact directly first the NCF to perform their *NCF SOP: Bounce NSBN Ingest Processes*
4. If PMB-Data Flow ***is*** notified by the SDM:

The **SDM shall also notify the NCF** (Ph: 301-713-9344) and open an AWIPS Support Ticket for the NSBN ingest/data-flow and have the NCF perform their **NCF NSBN SOP1: RESTART OF AWIPS PROCESSES FOR NSBN INGEST.**

If PMB-Data Flow ***is not*** notified by the SDM ( *assumption is that data is not-critical* ):

The **SDM shall regardless notify the NCF** (Ph: 301-713-9344) and open an AWIPS Support ticket for the NSBN ingest/data-flow and have the NCF perform their SOP to revert the data ingest to ARCHIVE-ONLY mode to avoid, **NCF NSBN SOP2: RESTART OF AWIPS PROCESSES FOR NSBN INGEST IN ARCHIVE MODE.**

The NCF will open a ticket and the NSBN will remain in ARCHIVE-ONLY mode until such time that the SDM notifies the NCF to restore the NSBN back to ingest mode.

The NCF ticket shall comply with the follow **Table 1: NCF Ticket Fill Values**

**Table 1: NCF Ticket Fill Values**

Field	Fill Value
<b>Category</b>	AWIPSII
<b>Type</b>	NCEP
<b>Item</b>	NSBN
<b>Node Bank</b>	CPSBN
<b>Severity</b>	<i>Case-by-Case</i>

5. Once PMB-Data Flow troubleshoots the CCS-to-AWIPS scripts, and determines that the problem is not related to the external push but rather with connections to-AWIPS, PMB-Data Flow will contact the SDM and report their findings with as much information as possible.
6. The SDM will contact the NCF and update the ticket with the information provided by PMB-Data Flow and direct the NCF, at the suggestion of PMB-Data Flow, to perform the following SOPs, **NCF NSBN SOP3: TROUBLESHOOTING NSBN DATA FLOW**
7. The NCF will update the SDM once the appropriate SOP is performed and identify if possible the root-cause of the problem if the problem has been resolved.
8. If the problem is not resolved, the NCF will notify the SDM of the current status and the SDM will coordinate with the affected site to determine if Tier Two support escalation is required from the NCF.
9. SDM will contact the NCF with the determination of escalation and NCF will follow standard operating procedures for escalation of data flow issues

**NCF Escalation Procedures**

**During the NSBN field operations, test, and evaluation (FOTE) period, the NCF will only perform NCF NSBN SOP1 & 2 at the request of the SDM.**

**NCF NSBN SOP 1: Restart NSBN AWIPS processes in OPERATIONAL MODE**

To quickly restart the NSBN ingest process on the AWIPS Communications Processor running the a2cp2apps high-availability resource group follow the below procedures. Note that these procedures are not meant to be troubleshooting steps, rather a quick step-by-step to restart processes should the need arise and do not account for any issues that may arise from the restart of the NSBN processes.

- 1) Connect to the physical server currently running the a2cp2apps resource and cpsbn2f virtual IP address after logging into the site at which a restart is required from the ANCF or other methods:

```
ssh -o StrictHostKeyChecking=no root@cpsbn2f
```

- 2) Switch users to the NSBN AWIPS DBnet user account under which all NSBN processes run

```
su - awpdbnet
```

- 3) Change to the directory under which execution occurs for the scripts:

```
cd /home/awpdbnet/bin; ./nsbn_ingest restart
```

- 4) Verify that the NSBN scripts started back up:

- (a) Check that the nsbn\_run shell script started back up for the data types:

```
ps -ef|grep nsbn_run|awk '{print $10,$11}'
```

- (b) Check that the logfiles are updating (note below only the GRIB ingest log is shown):

```
tail -100f /home/awpdbnet/logs/nsbn-grib.log
```

- 5) Verify that NSBN raw data endpoints are listed in the edex-ingest logfiles on an EDEX Processing Server:

```
ssh dx3 "tail -100f /awips2/edex/logs/edex-ingestGrib-20140609.log | grep nsbn_store"
```

- 6) Contact the POC whom requested the restart, and garnish information on the POCs desires for the handling of the trouble ticket (e.g. escalate immediately or wait until business hours, close, follow-up later, etc.).

**NCF NSBN SOP2: Restart NSBN AWIPS processes in ARCHIVE-ONLY**

To quickly restart the NSBN ingest process into ARCHIVE ONLY mode on the AWIPS Communications Processor running the a2cp2apps high-availability resource group follow the below procedures. Note that these procedures are not meant to be troubleshooting steps, rather a quick step-by-step to restart processes should the need arise and do not account for any issues that may arise from the restart of the NSBN processes.

- 1) Connect to the physical server currently running the a2cp2apps resource and cpsbn2f virtual IP address after logging into the site at which a restart is required from the ANCF or other methods:

```
ssh -o StrictHostKeyChecking=no root@cpsbn2f
```

- 2) Switch users to the NSBN AWIPS DBnet user account under which all NSBN processes run

```
su - awpdbnet
```

- 3) Change to the directory under which execution occurs for the scripts:

```
cd /home/awpdbnet/bin; ./nsbn_ingest archive
```

- 4) Verify that the NSBN scripts started back up in ARCHIVE-ONLY mode, for this instance, the output of check (10a) should show the data-type as field \$10 and the mode in field \$11. The mode should read “archive” for all data types listed:

- (a) Check that the nsbn\_run shell script started back up for the data types:

```
ps -ef|grep nsbn_run|awk '{print $10,$11}'
```

- (b) Check that the logfiles are not indicating messages sent to qpid:

```
tail -100f  
/home/awpdbnet/logs/qpidNotify.log
```

- 5) Verify that NSBN raw data endpoints are not listed in the edex-ingest logfiles on an EDEX Processing Server:

```
ssh dx3 "tail -100f /awips2/edex/logs/edex-  
ingestGrib-20140609.log | grep nsbn_store"
```

Contact the POC whom requested the restart, and garnish information on the POCs desires for the handling of the trouble ticket (e.g. escalate immediately or wait until business hours, close, follow-up later, etc.).

### **NCF NSBN SOP3: Troubleshooting NSBN Ingest Issues**

The following is meant to troubleshoot NSBN ingest issues related to missing and/or incomplete data available within the AWIPS CAVE perspectives (D2D, GFE, NCP).

- 1) Connect to the physical server currently running the a2cp2apps resource and cpsbn2f virtual IP address (after logging into the site) from the ANCF or other methods:

```
ssh -o StrictHostKeyChecking=no root@cpsbn2f
```

- 2) Check that the NSBN ingest scripts are running:

```
su - awpdbnet
```

- 3) Change to the directory under which execution occurs for the scripts:

```
cd /home/awpdbnet/bin; ./nsbn_ingest archive
```

- 4) Verify that the NSBN scripts started back up in ARCHIVE-ONLY mode, for this instance, the output of check (10a) should show the data-type as field \$10 and the mode in field \$11. The mode should read “archive” for all data types listed:

- (a) Check that the nsbn\_run shell script started back up for the data types:

```
ps -ef|grep nsbn_run|awk '{print $10,$11}'
```

- (b) Check that the logfiles are not indicating messages sent to qpid:

```
tail -100f  
/home/awpdbnet/logs/qpidNotify.log
```

- 5) Verify that NSBN raw data endpoints are not listed in the edex-ingest logfiles on an EDEX Processing Server:

```
ssh dx3 "tail -100f /awips2/edex/logs/edex-  
ingestGrib-20140609.log | grep nsbn_store"
```

- 6) Contact the POC whom requested the restart, and garnish information on the POCs desires for the handling of the trouble ticket (e.g. escalate immediately or wait until business hours, close, follow-up later, etc.).

**Appendix C**  
**Directories for /awips2/edex/data and**  
**/data/fxa**

**Appendix C.**  
**Directories for /awips2/edex/data and /data/fxa**

**Table of Contents**

	<i>Page</i>
C.1 Data Directories in /awips2/edex/data .....	1
C.2 Directory Tree for /data/fxa .....	11

This appendix includes two sections. Section C.1 contains the /awips2/edex/data directory, and Section C.2 contains the outline for the /data/fxa directory tree.

### C.1 *Data Directories in /awips2/edex/data*

/awips2/edex/data

/hdf5

- |               |                                                                                                                                                                                                                              |
|---------------|------------------------------------------------------------------------------------------------------------------------------------------------------------------------------------------------------------------------------|
| /airep        | Contains decoded airep products in HDF5 format.<br>Example: /awips2/edex/hdf5/airep/airep-2014-05-13-01.h5                                                                                                                   |
| /binlightning | Contains decoded binlightning products in HDF5 format.<br>/awips2/edex/data/hdf5/binlightning/<model>-<yyyy>-<mm>-<dd>-<hh>.h5 in HDF% format.<br>Example: /awips2/edex/data/hdf5/binlightning/binlightning-2013-02-06-10.h5 |
| /bufrascat    | Contains decoded bufrascat products in HDF5 format.<br>awips2/edex/data/hdf5/bufrascat/<model>-<yyyy>-<mm>-<dd>-<hh>.h5 in HDF% format.<br>Example: /awips2/edex/data/hdf5/bufrascat/ascat-2011-07-04-12.h5                  |
| /bufrhdw      | Contains decoded bufrhdw products in HDF5 format.<br>awips2/edex/data/hdf5/bufrhdw/<model>-<yyyy>-<mm>-<dd>-<hh>.h5 in HDF% format.<br>Example: /awips2/edex/data/hdf5/bufrhdw/hdw-2011-10-19-11.h5                          |
| bufrmthdw     | Contains decoded bufrmthdw products in HDF5 format.<br>awips2/edex/data/hdf5/bufrmthdw/<model>-<yyyy>-<mm>-<dd>-<hh>.h5 in HDF% format.<br>Example: /awips2/edex/data/hdf5/bufrmthdw/mthdw-2011-10-19-11.h5                  |
| /bufrmosGFS   | All decoded bufrmosGFS data are under<br>/awips2/edex/data/hdf5/bufrmosGFS/<model>-<yyyy>-<mm>-<dd>-<hh>.h5 in HDF% format.                                                                                                  |



Example: /awips2/edex/data/hdf5/bufrmosGFS/bufrmos-GFS-2011-10-19-11.h5

/bufrmosHPC All decoded bufrmosHPC data are under  
/awips2/edex/data/hdf5/bufrmosHPC/<model>-<yyyy>-<mm>-<dd>-<hh>.h5 in HDF5 format.

Example: /awips2/edex/data/hdf5/bufrmosHPC/bufrmos-HPC-2011-10-19-00.h5

/bufrmosLAMP All decoded bufrmosLAMP data are under  
/awips2/edex/data/hdf5/bufrmosLAMP/<model>-<yyyy>-<mm>-<dd>-<hh>.h5 in HDF5 format.

Example: /awips2/edex/data/hdf5/bufrmosLAMP/bufrmos-LAMP-2011-10-19-11.h5

/bufrmosAVN All decoded bufrmosAVN data are under  
/awips2/edex/data/hdf5/bufrmosAVN/<model>-<yyyy>-<mm>-<dd>-<hh>.h5 in HDF5 format.

Example: /awips2/edex/data/hdf5/bufrmosAVN/bufrmos-AVN-2011-10-23-11.h5

/bufrmosMRF All decoded bufrmosMRF data are under  
/awips2/edex/data/hdf5/bufrmosMRF/<model>-<yyyy>-<mm>-<dd>-<hh>.h5 in HDF5 format.

Example: /awips2/edex/data/hdf5/bufrmosMRF/bufrmos-MRF-2011-10-23-11.h5

/bufrmosETA All decoded bufrmosETA data are under  
/awips2/edex/data/hdf5/bufrmosETA/<model>-<yyyy>-<mm>-<dd>-<hh>.h5 in HDF5 format.

Example: e.g.: /awips2/edex/data/hdf5/bufrmosETA/bufrmos-ETA-2011-10-23-11.h5

/bufrncwf Contains decoded bufrncwf products in HDF5 format.  
awips2/edex/data/hdf5/bufrncwf/<model>-<yyyy>-<mm>-<dd>-<hh>.h5 in HDF% format.

Example: /awips2/edex/data/hdf5/bufrncwf/bufrncwf-2011-10-19-22.h5

/bufrsigwx	<p>Contains decoded bufrsigwx products in HDF5 format.</p> <p>There are three directories under /bufrsigwx</p> <p><b>SWBOTH, SWH, SWM</b></p> <p>SWBOTH: sigwxVTS-2011-07-04-18.h5</p> <p>SWH: sigwxCAT-2011-07-05-06.h5, sigwxCLOUD-SWH-2011-07-05-00.h5, sigwxJETS-2011-07-05-06.h5, sigwxTROP-2012-10-29-18.h5</p> <p>SWM: sigwxCLOUD-SWM-2011-07-04-18.h5, sigwxCAT-2011-07-05-00.h5, sigwxTROP-2012-10-31-06.h5, sigwxJETS-2012-10-28-12.h5</p>
/bufrssmi	<p>Contains decoded bufrssmi products in HDF5 format.</p> <p>awips2/edex/data/hdf5/bufrssmi/&lt;model&gt;-&lt;yyyy&gt;-&lt;mm&gt;-&lt;dd&gt;-&lt;hh&gt;.h5 in HDF% format.</p> <p>Example: /awips2/edex/data/hdf5/bufrssmi/ssmi-2011-10-26-16.h5</p>
/bufrua	<p>Contains decoded bufrua products in HDF5 format.</p> <p>awips2/edex/data/hdf5/bufrua/&lt;model&gt;-&lt;yyyy&gt;-&lt;mm&gt;-&lt;dd&gt;-&lt;hh&gt;.h5 in HDF% format.</p> <p>Example: /awips2/edex/data/hdf5/bufrua/bufrua-2011-10-25-06.h5</p>
/cwa	<p>Contains decoded cwa products in HDF5 format.</p> <p>awips2/edex/data/hdf5/cwa/&lt;model&gt;-&lt;yyyy&gt;-&lt;mm&gt;-&lt;dd&gt;-&lt;hh&gt;.h5 in HDF% format.</p> <p>Example: /awips2/edex/data/hdf5/cwa/cwa-2013-02-05-02-16.h5</p>
/cwat	<p>Contains decoded cwat products in HDF5 format.</p> <p>Example: /awips2/edex/data/hdf5/cwat/cwat-2011-11-01-02-02.h5</p>
/ffmp	<p>Contains decoded ffmp products in HDF5 format.</p> <p>Example: /awips2/edex/data/hdf5/ffmp/ffmp-2011-11-01-02-02.h5</p>

/fog	Contains decoded fog products in HDF5 format.  Example: /awips2/edex/data/hdf5/fog/fog-2011-10-13-16-02.h5
fssobs	Contains decoded obs products in HDF5 format.  Example: /awips2/edex/data/hdf5/fssobs/fssobs-2012-07-09-16.h5
/gfe	Contains forecast grids created by GFE and Smart Init  /awips2/edex/data/hdf5/gfe/BOX  (Note: The contents of this directory are based on the 14.3.1 @ tbdw)  DGEX GFS40 HIRESWnmm HRRR MSAS Official SAT ESTOFS GFS80 HPCGuide ISC NAM12 RTMA SREF Fcst HIRESWarw HPCQPF MOSGuide NamDNG5 RUC13 Topo
/goessounding	Contains decoded goessounding products in HDF5 format.  Example: /awips2/edex/data/hdf5/goessounding/goessounding-2011-10-19-11.h5
/grid	Contains decoded grib products in HDF5 format.

AK-RTMA3	HFR-US_WEST_LOSOSOS_1KM	RTOFS-Now-Honolulu
AKwave10	HFR-US_WEST_NORTH_2KM	RTOFS-Now-HudsonBaffin
AKWAVE239	HFR-US_WEST_SANFRAN_1KM	RTOFS-Now-Samoa
AKwave4	HFR-US_WEST_SOCAL_2KM	RTOFS-Now-TropPaciLowres
AUTOSPE	HFR-US_WEST_WASHINGTON_1KM	RTOFS-Now-WestAtl
Aviation	HFR-WEST_6KM	RTOFS-Now-WestConus
AVN211	HI-NamDNG5	RTOFS-Samoa
AVN225	HiResW-ARW-AK	RTOFS-Now-TropPaciLowres
AVN37	HiResW-ARW-East	RTOFS-Now-WestAtl
AVN38	HiResW-ARW-GU	RTOFS-Now-WestConus
AVN39	HiResW-ARW-HI	RTOFS-Samoa
AVN40	HiResW-ARW-SJU	RTOFS-TropPaciLowres
AVN41	HiResW-ARW-West	RTOFS-WestAtl
AVN42	HiResW-NMM-AK	RTOFS-WestConus
AVN43	HiResW-NMM-East	RUC130

AVN44	HiResW-NMM-GU	RUC236
BHPE	HiResW-NMM-HI	Sealce
DGEX185	HiResW-NMM-SJU	SPCGuide
DGEX186	HiResW-NMM-West	SREF212
ECMF1	HI-RTMA	SREF216
ECMF2	HPCGuide	SREF243
ECMF3	HPCGuide-AK	TPCWindProb
ECMF4	HPCqpf	UKMET37
ECMF5	HPCqpfNDFD	UKMET38
ECMF6	HPE	UKMET39
ECMF7	HRRR	UKMET40
ECMF8	LAPS	UKMET-NorthernHemisphere
ECMF-NorthernHemisphere	mesoEta212	URMA25
ECMF-Tropical	mesoEta215	WCwave10
ENSEMBLE40	mesoEta216	WCwave4
EPwave10	mesoEta217	WNAwave10
estofsAK	mesoEta237	WNAWAVE238
estofsEP	MOSGuide	WNAwave4
estofsHI	MOSGuide-AK	RTOFS-Now-Honolulu
estofsPR	MPE-Local	RTOFS-Now-HudsonBaffin
estofsUS	MPE-Local-ALR	RTOFS-Now-Samoa
ETA	MPE-Local-MSR	RTOFS-Now-TropPaciLowres
ETA207	MPE-Local-ORN	RTOFS-Now-WestAtl
ETA212	MPE-Local-RHA	RTOFS-Now-WestConus
ETA218	MPE-Local-RSA	RTOFS-Samoa
ETA242	MPE-Local-STR	RTOFS-Now-TropPaciLowres
ETSS	MPE-Local-TAR	RTOFS-Now-WestAtl
FFG-ALR	MPE-Local-TIR	RTOFS-Now-WestConus
FFG-FWR	MPE-Local-TUA	RTOFS-Samoa
FFG-KRF	MPE-Mosaic-ALR	RTOFS-TropPaciLowres
FFG-MSR	MPE-Mosaic-FWR	RTOFS-WestAtl
FFG-ORN	MPE-Mosaic-MSR	RTOFS-WestConus
FFG-PTR	MPE-Mosaic-ORN	RUC130
FFG-RHA	MPE-Mosaic-RHA	RUC236
FFG-RSA	MPE-Mosaic-TAR	Sealce
FFG-STR	MPE-Mosaic-TIR	SPCGuide
FFG-TAR	MRMS_0500	SREF212
FFG-TIR	MRMS_1000	SREF216
FFG-TUA	MSAS	SREF243
GEFS	NamDNG5	TPCWindProb
GFS160	NCWF	UKMET37
GFS161	NOHRSC-SNOW	UKMET38

GFS199	PR-NamDNG5	UKMET39
GFS201	PROB3HR	UKMET40
GFS20-PRICO	PR-RTMA	UKMET-NorthernHemisphere
GFS212	QPE-ALR	URMA25
GFS213	QPE-Auto-TUA	WCwave10
GFS215	QPE-FWR	WCwave4
GFS217	QPE-KRF	WNAwave10
GFS229	QPE-MSR	WNAWAVE238
GFS254	QPE-RFC-PTR	WNAwave4
GFSGuide	QPE-RFC-RSA	
GFSLAMPGrid	QPE-RFC-STR	
GLERL	QPE-TAR	
GlobalWave	QPE-TIR	
GribModel:7:14:0	QPE-TUA	
GribModel:7:2:111	QPE-XNAV-ALR	
GribModel:7:2:116	QPE-XNAV-FWR	
GribModel:7:4:118	QPE-XNAV-KRF	
GribModel:9:105:160	QPE-XNAV-MSR	
GribModel:9:105:161	QPE-XNAV-ORN	
GribModel:9:105:171	QPE-XNAV-RHA	
GRLKwave	QPE-XNAV-TAR	
Guam-RTMA	QPE-XNAV-TIR	
GWW233	QPE-XNAV-TUA	
HFR-EAST_6KM	RCM	
HFR-EAST_PR_6KM	RFCqpf	
HFR-US_EAST_DELAWARE_1KM	RTGSSTHR	
HFR-US_EAST_FLORIDA_2KM	RTMA	
HFR-US_EAST_NORTH_2KM	RTMA25	
HFR-US_EAST_SOUTH_2KM	RTOFS-Alaska	
HFR-US_EAST_VIRGINIA_1KM	RTOFS-Arctic	
HFR-US_HAWAII_1KM	RTOFS-Bering	
HFR-US_HAWAII_2KM	RTOFS-Now-Bering	
HFR-US_HAWAII_6KM	RTOFS-Now-Guam	
HFR-US_WEST_500M	RTOFS-Now-GulfAlaska	
HFR-US_WEST_CENCAL_2KM		

ldadhydro

Contains decoded ldadhydro products in HDF5 format.

Example: /awips2/edex/data/hdf5/ldadhydro/ldadhydro-2014-02-13-15.h5

/ldadmsonet

Contains decoded ldadmsonet products in HDF5 format.

Example: /awips2/edex/data/hdf5/ldadmsonet/ldadmsonet-2013-02-06-23.h5

---

/lsr	Contains decoded lsr products in HDF5 format. Example: /awips2/edex/data/hdf5/lsr/lsr-2011-10-22-23.h5
/modelsounding	Contains decoded modelsounding products in HDF5 format. ETA and GFS  Example: ETA /awips2/edex/data/hdf5/modelsounding/modelsounding/ETA/ 2015-08-24_06:00:00.0  Example: GFS  awips2/edex/data/hdf5/modelsounding/modelsounding/GFS/ 2015-08-24_06:00:00.0
/mosaic	Contains mosaic products in HDF5 format.
/ncpafm	Contains ncpafm products in HDF5 format.  Example: /awips2/edex/data/hdf5/ncpafm/ncpafm-2015-01-21- 06.h5
/nctaf	Contains National Centers TAF products in HDF5 format.  Example: /awips2/edex/data/hdf5/nctaf/ nctafs-2015-01-21- 08.h5
/ntrans	Contains gfs ntrans products in HDF5 format.  Example: /awips2/edex/data/hdf5/ntrans/gfs/gfs-20130924-12-us
/ncscat, /ncuair/, /ncscat	Contains National Center products in HDF5 format.
/nucaps	Contains nucaps products in HDF5 format.
/pgen	Contains pgen products in HDF5 format.  Example: /awips2/edex/data/hdf5/pgen/pgen-2013-10-24-20.h5
/obs	Contains decoded obs (metar) products in HDF5 format.  Example: /awips2/edex/data/hdf5/obs/metar-2011-10-23-06.h5
/poessounding	Contains decoded poessounding products in HDF5 format.

	Example: /awips2/edex/data/hdf5/poessounding/poessounding-2011-10-23-11.h5
/preciprate	Contains preciprate products in HDF5 format Example: /awips2/edex/data/hdf5/preciprate/preciprate-2012-07-02-17-21.h5
/profiler	Contains decoded profiler products in HDF5 format. Example: /awips2/edex/data/hdf5/profiler/profiler-2011-10-31-17.h5
/qpf	Contains decoded qpf products in HDF5 format. Example: /awips2/edex/data/hdf5/qpf/qpf-2011-11-01-03-11.h5
/QC	Contains ldadmsonet and msas products
/radar	Contains radar products in HDF5 format under each site. Example: /awips2/edex/data/hdf5/radar/kabr/1.5/radar-kabr-2011-11-01-03.h5
/redbook	Contains decoded redbook products in HDF5 format. Example: /awips2/edex/data/hdf5/redbook/PEWA34/redbook-2013-02-06-12-2.h5
/satellite	Contains decoded satellite products in HDF5 format. Under each satellite directory, you will find the SOURCE directory: Alaska National Alaska Regional eastconus East CONUS Hawaii National Hawaii Regional NH Composite - Meteosat-GOES E-GOES W-GMS Northern Hemisphere Composite Puerto Rico National Puerto Rico Regional Supernational

## West CONUS

Under each SOURCE directory, you will find the RESOLUTION directory.

For example, under East CONUS, you will find the following directories:

Imager 11 micron IR	Sounder 14.06 micron imagery
Imager 13 micron (IR)	Sounder 3.98 micron imagery
Imager 3.9 micron IR	Sounder 4.45 micron imagery
Imager 6.7-6.5 micron IR (WV)	Sounder 6.51 micron imagery
Imager Visible	Sounder 7.02 micron imagery
Low cloud base imagery	Sounder 7.43 micron imagery
Sounder 11.03 micron imagery	Sounder Visible imagery

Under Puerto Rico National, you will find the following directories:

Imager 11 micron IR	Sounder 3.98 micron imagery
Imager 6.7-6.5 micron IR (WV)	Sounder 4.45 micron imagery
Imager Visible	Sounder 6.51 micron imagery
Percent of Normal TPW	Sounder 7.02 micron imagery
Rain fall rate	Sounder 7.43 micron imagery
Sounder 11.03 micron imagery	Sounder Based Derived Precipitable Water (PW)
Sounder 14.06 micron imagery	Sounder Visible imagery

Under each RESOLUTION directory, you will find the satellite products.

For example, under Imager Visible, you will find the following satellite products:

satellite-2013-02-08-01.h5 satellite-2013-02-08-11.h5  
 satellite-2013-02-08-02.h5 satellite-2013-02-08-12.h5  
 satellite-2013-02-08-03.h5 satellite-2013-02-08-13.h5  
 satellite-2013-02-08-04.h5 satellite-2013-02-08-14.h5  
 satellite-2013-02-08-05.h5 satellite-2013-02-08-15.h5  
 satellite-2013-02-08-10.h5 satellite-2013-02-08-16.h5



---

/scan	Contains decoded scan products in HDF5 format. Example: /awips2/edex/data/hdf5/scan/scan-2011-10-31-19-04.h5
/sfcobs	Contains decoded sfcobs products in HDF5 format. Under sfcobs you will find the following directories: 1001 1003 1004 1005 1006 1007 Under each directory, you will find the corresponding sfcobs products. Example: awips2/edex/data/hdf5/sfcobs/1003/sfcobs-2011-10-04-12.h5
/stq	Contains decoded stq products.
/solarimage	Contains decoded solarimage products in HDF5 format.
/svrwx	Contains decoded svrwx products in HDF5 format. Example: /awips2/edex/data/hdf5/svrwx/svrwx-2013-02-05-21.h5
/tcg	Contains decoded tcg products in HDF5 format. Example: /awips2/edex/data/hdf5/tcg/tcg-2013-12-05-21.h5
/tcs	Contains decoded tcs products in HDF5 format. Example: /awips2/edex/data/hdf5/tcs/tcs-2015--08-24.h5
/topo	Contains topo files akTopo.dat.gz gtopo30.h5 orig-srtm30.hdf srtm30_plus.h5 work-srtm30.hdf caribTopo.dat.gz licenses pacTopo.dat.gz staticTopo.h5 worldTopo.dat.gz defaultTopo.h5 modelStaticTopo.h5

	srtm30.h5
	usTopo.dat.gz
/vil	Contains decoded vil products in HDF5 format.  Example: /awips2/edex/data/hdf5/vil/vil-2013-02-05-16.h5  <b>Note:</b> vil is a radar-based product that shows liquid amounts. VIL stands for “Vertically Integrated Liquid.” Also in this group are Digital Vertically Integrated Liquid (DVIL) and Enhanced Vertically Integrated Liquid (EDVIL). Each HDF5 file contains all three of these products, which are stored as displayable data blobs (two dimensional grids). For VIL, the grid size is 4KM; the other two are 1 km grids.
/viirs	Placeholder for Alaska Region
/utility	Placeholder for cave_config, cave_static, common_static, edex_static files.

## C.2 Directory Tree for /data/fxa

Directory	Description
/afos	NOT IN USE
/aiv	NOT IN USE
/archive	NOT IN USE
/ax_refresh	NOT IN USE
/badRadar	NOT IN USE
/badSatellite	NOT IN USE
/badText	NOT IN USE
/customFiles	NOT IN USE
/CP_PARTITION	CP Partition
/data	data
/dgm	NOT IN USE
/DRT	NOT IN USE
/elt	NOT IN USE
/eLog	NOT IN USE
/flatText	NOT IN USE
/freeware	NOT IN USE
/freeway	NOT IN USE
/Grid	NOT IN USE
/hazCollect	NOT IN USE
/img	NOT IN USE
/ispan	NOT IN USE
/INSTALL	NOT IN USE
/install_root	NOT IN USE

---

/j24	NOT IN USE
/laps	LAPS
/laps_data	LAPS data
/laps_domain	LAPS domain
/laps_geog	LAPS geography
/LDAD	NOT IN USE
/ldadScheduler	NOT IN USE
/mhs	NOT IN USE
/nationalData	NOT IN USE
/nwr	NOT IN USE
/nwws	NOT IN USE
/point	NOT IN USE
/pgdata	NOT IN USE
/radar	NOT IN USE
/redbook	NOT IN USE
/rps-lists	NOT IN USE
/sat	NOT IN USE
/siteConfig	NOT IN USE
/textWSwork	NOT IN USE
/tmp	NOT IN USE
/trigger	NOT IN USE
/tstorm	NOT IN USE
/userSkewTs	NOT IN USE
/userPrefs	AWIPS user preferences files
/verification	NOT IN USE
/vgf	NOT IN USE
/workFiles	Temporary files

## **Appendix D**

### **Glossary**

<b>ADE</b>	AWIPS Development Environment
<b>ARI</b>	Average Recurrence Interval
<b>AlertViz</b>	The AWIPS II version of the AWIPS I Guardian application. AlertViz is designed to present various notifications, error messages, and alarms to the user. AlertViz can be executed either independently or from CAVE itself.
<b>Broadcast Message Handler</b>	Migrate's NOAA Weather Radio (NWR), Console Replacement System (CRS) functionality into AWIPS II infrastructure.
<b>Boundary Drawing Tool</b>	Boundary Tool allows the forecaster to add new surface boundaries, adjust the positions of existing boundaries, set a stationary boundary to motion, modify the speed of a moving boundary or end an active boundary.
<b>CAVE</b>	Common AWIPS Visualization Environment, the unified display client for AWIPS II. CAVE is implemented using the Eclipse framework and consists of multiple display perspectives that can run concurrently.
<b>caveData</b>	A directory created by CAVE in each user's home directory. caveData stores a local copy of customization and configuration settings. When CAVE starts, in theory, it refreshes caveData with the current settings from the EDEX server.
<b>Collaboration</b>	A component of CAVE, which offers two main functions, chatting and sharing displays. "Chat" allows users to chat with fellow forecasters and offices in a chat room or send them instant messages. "Sharing displays" adds to the chat room's capabilities and allows the room's creator to show a CAVE map display to other participants in the room.
<b>Damage Path Tool</b>	The Damage Path tool allows users to create a polygon to outline a damage path caused by a storm. When initially loading the Damage Path tool, a default polygon displays. Users may edit the location of the vertices as well as move the entire polygon by clicking and holding MB1 on a vertex or polygon and dragging the vertex or polygon to another location.
<b>Focus</b>	A state of the system that indicates which component receives keyboard events. A component is said to have the focus if keyboard events are sent to that component.
<b>EDEX</b>	Environmental Data Exchange, the server for AWIPS II. EDEX ingests, decodes, stores, catalogs, and archives all the data used by AWIPS II. It also feeds data to the various CAVE clients.

- endpoint** Refers (when used within the context of a Service Oriented Architecture) to the beginning and destination of a particular service. In AWIPS II, “endpoint” commonly refers to the file endpoints that the various EDEX data decoders can use to read data. One way (though not necessarily the most preferred way) to feed data into EDEX is simply to have another program put a file in the proper file endpoint. For example, putting a text file that contains a metar in the endpoint directory of the obs decoder (/awips2/edex/data/SBN/metar) causes the obs decoder to execute using the input text file.
- Ensemble** The Ensemble Tool provides capabilities to display and manipulate ensemble model data. The datasets and the Tool are there to help forecasters assess uncertainty in the forecast, or lack thereof. This is intended to assist forecasters with interactive decision support in two ways: estimates of event probability, and alternative scenarios to the official (deterministic) forecast.
- Hibernate** An open-source project used in AWIPS II to provide connectivity between the PostgreSQL database for metadata and the JAVA code itself. Hibernate provides several methodologies to map database fields to variables and complex data objects in Java using either XML configuration files or special annotations in the JAVA code.
- Himawari** The products available from the Himawari are provided by the Japanese Meteorological Agency’s Himawari 8 satellite. The main instrument aboard satellite is the Advanced Himawari Imager (AHI). This is a 16-channel multispectral imager that captures visible light and infrared images of the Asia-Pacific region. The instrument has similar spectral and spatial characteristics to the Advanced Baseline Imager (ABI) used by the GOES-R satellites.
- LDM** Local Data Manager software, written and supported by Unidata. Many meteorological entities use LDM to manage the movement of data. LDM often connects data that comes from a NOAAPORT or AWIPS Satellite Broadcast Network (SBN) receiver to any number of downstream clients. These downstream clients might store the data, decode the data, or perform other functions on the data in an event-driven manner as the data arrive. In AWIPS II, the LDM provides the link between the AWIPS SBN, which receives raw data via satellite, and EDEX, which decodes and stores the data. In the normal AWIPS II, the LDM writes data directly into an archive and sends a message to EDEX using Qpid. The message tells EDEX that the particular data file is available for processing and uses a file header to determine what kind of file it is.

<b>metadata</b>	Generally defined as “data about data.” In AWIPS II, metadata refers either to either a specific PostgreSQL database or to the data contained within it. AWIPS II queries this metadata database to keep track of what data is currently available. In AWIPS I, the system would search through a system of files to find a particular piece or slice of data, such as radar, surface, model, or satellite data. In AWIPS II, particular pieces of data have a unique identifier, known as a dataURI, which contains enough information to specify the data. For example, metadata for a radar product might contain the radar id, the volume scan time, the elevation angle, and the product type.
<b>MRMS</b>	Multiple-Radar / Multiple-Sensor system  Multi-Radar: Exploits the overlapping coverage of the WSR-88D network and the Level-II real-time data feeds to build a seamless rapidly-updating high-resolution three-dimensional cube of radar data.  Multi-Sensor: Objectively blends data from the multiple-radar 3D cubes with surface, upper air, lightning, satellite, rain gauges, and NWP environmental data, to produce highly-robust decision assistance products.  Improvements demonstrated in QPE, severe weather diagnosis, warning decision efficiency, NWP, etc.
<b>NUCAPS</b>	NUCAPS, short for ‘NOAA Unique Cross-track Infrared Sounder (CrIS) and Advanced Technology Microwave Sounder (ATMS) Product System,’ is under development at the NOAA/NESDIS Center for Satellite Applications and Research. The system will produce thinned apodized CrIS radiances, principal components of CrIS radiances, cloud-cleared CrIS radiances, and trace gas profile products for Numerical Weather Prediction (NWP) customers in near real-time.
<b>Python</b>	The main scripting language used in AWIPS II.
<b>Qpid</b>	Queue Processor Interface Daemon, the messaging system used in AWIPS II. An open-source project, Qpid is an implementation of the Advanced Message Queuing Protocol. When the LDM receives a data file to be processed, it sends EDEX a message using Qpid. When EDEX has finished decoding the file, it sends CAVE and any other listeners a message that says the particular piece of data (referenced by a dataURI) is available for display or further processing.
<b>Re-engineered</b>	Some applications in AWIPS II were completely rewritten. These re-

---

<b>application</b>	engineered applications include GFE, D2D, and FFMP.
<b>Re-hosted application</b>	The localization and configuration of these applications are the same as for AWIPS I. Examples of Re-hosted applications include Climate, NWRWAVES, HazCollect, and NOAA Weather Wire Service (NWS) Interface.
<b>SOA</b>	Service Oriented Architecture, the design philosophy behind AWIPS II. In SOA, major system functions are <i>services</i> , and they are loosely coupled, rather than having large monolithic programs. In AWIPS II, raw data are ingested by an IngestSrv service, and are stored using a PersistSrv service. Camel “wires” or connects the services together (i.e., connecting the endpoints of successive services together) using XML configuration files, and the services can be modified without significantly affecting one another.
<b>Tear-Away Menu</b>	A menu that can be moved around the workstation screen, away from the location on the screen where it first opened, by grabbing it in the title area and repositioning it on the screen.
<b>Thin Client</b>	A component that implements support for NWS enterprise requirements for remote access to baseline AWIPS II capabilities. The Thin Client will take advantage of new and enhanced AWIPS II capabilities in a seamless manner as they are deployed to the baseline.
<b>Tracking Meteogram Tool</b>	The Tracking Meteogram Tool provides a general function wherein the forecaster can produce a time-trend graph for nearly any grid/image data parameters that have been loaded into the D2D before the Tracking Meteogram Tool itself. The User Interface for the Tracking Meteogram Tool should be intuitive, as it was designed based on other existing tools, such as the Time of Arrival Tool and WarnGen.
<b>utility store</b>	A collection of utility data. The utility store is part of EDEX, and is typically located at /awips2/edex/data/utility/.
<b>Velocity</b>	An open-source template language. AWIPS II uses Velocity to construct WarnGen templates. Certain variables from the WarnGen JAVA code and data fields from the PostgreSQL database have been exposed to the Velocity templates, meaning that this data is available for use by Velocity. Because Velocity is an actual language, it has the ability to perform calculations and comparisons without having to recompile the WarnGen code itself.
<b>Urban Boundaries</b>	An application that allows more accurate and detailed city information in the WarnGen third and fourth bullets.
<b>WES-2 Bridge</b>	Weather Event Simulator bridge that provides training and simulation



capabilities for AWIPS II platform

**XML**

Extensible Markup Language. XML is not a programming language; rather, it is a common and structured way of formatting data, especially data that contains settings and preferences. In AWIPS II, most of the configuration files are stored in XML-formatted files.

# **Appendix E**

## **Mass Storage Design**

## Appendix E. Mass Storage Design

### Table of Contents

	<i>Page</i>
E.1 LS Drive Allocations .....	1
E.2 Linux LX-Drive Allocation .....	1
E.3 Linux XT-Drive Allocation .....	1
E.4 PX Drive Allocation .....	2
E.5 Linux DX Drive Allocation and Linux DX Shared Database Allocation.....	2

This appendix provides current AWIPS system disk allocations. The examples shown below are from site BCQ.

### ***E.1 LS Drive Allocations***

#### **Volume Group:**

<b>VG Name</b>	<b>vg00</b>
VG Size	232.42 GiB
PE Size	4.00 MiB
Total PE	59499
Alloc PE / Size	54016 / 211.00 GiB
Free PE / Size	5483 / 21.42 GiB
<b>VG Name</b>	<b>vg01</b>
VG Size	232.42 GiB
PE Size	4.00 MiB
Total PE	59499
Alloc PE / Size	54016 / 211.00 GiB
Free PE / Size	5483 / 21.42 GiB
<b>VG Name</b>	<b>vg02</b>
VG Size	465.73 GiB
PE Size	4.00 MiB
Total PE	119226
Alloc PE / Size	119040 / 465.00 GiB
Free PE / Size	159 / 636.00 MiB

### ***E.2 Linux LX-Drive Allocation***

#### **Volume Group:**

<b>VG Name</b>	<b>vg00</b>
VG Size	238.36 GiB
PE Size	4.00 MiB
Total PE	61021
Alloc PE / Size	9974 / 38.96 GiB
Free PE / Size	51047 / 199.40 GiB

### ***E.3 Linux XT-Drive Allocation***

#### **Volume Group:**

<b>VG Name</b>	<b>vg00</b>
VG Size	68.00 GiB
PE Size	4.00 MiB
Total PE	17407
Alloc PE / Size	8700 / 33.98 GiB
Free PE / Size	8707 / 34.01 GiB
<b>VG Name</b>	<b>vg01</b>

VG Size	68.00 GiB
PE Size	4.00 MiB
Total PE	17407
Alloc PE / Size	9224 / 36.03 GiB
Free PE / Size	8183 / 31.96 GiB

#### ***E.4 PX Drive Allocation***

##### **Volume Group:**

<b>VG Name</b>	<b>vg00</b>
VG Size	67.50 GiB
PE Size	4.00 MiB
Total PE	17279
Alloc PE / Size	8075 / 31.54 GiB
Free PE / Size	9204 / 35.95 GiB
<b>VG Name</b>	<b>vg01</b>
VG Size	67.50 GiB
PE Size	4.00 MiB
Total PE	17279
Alloc PE / Size	14309 / 55.89 GiB
Free PE / Size	2970 / 11.60 GiB

#### ***E.5 Linux DX Drive Allocation and Linux DX Shared Database Allocation***

##### **DX1/DX2**

##### **Volume Group:**

<b>VG Name</b>	<b>vg00</b>
VG Size	67.50 GiB
PE Size	4.00 MiB
Total PE	17279
Alloc PE / Size	16914 / 66.07 GiB
Free PE / Size	365 / 1.43 GiB
<b>VG Name</b>	<b>vg01</b>
VG Size	67.50 GiB
PE Size	4.00 MiB
Total PE	17279
Alloc PE / Size	17039 / 66.56 GiB
Free PE / Size	240 / 960.00 GiB
<b>VG Name</b>	<b>vg_aiihdf5</b>
VG Size	399.04 GiB
PE Size	4.00 MiB
Total PE	102154
Alloc PE / Size	102144 / 399.00 GiB

```
Free PE / Size          10 / 40.00 MiB

VG Name                vg_aiidb
VG Size                 249.00 GiB
PE Size                 4.00 MiB
Total PE                63745
Alloc PE / Size        38400 / 150.00 GiB
Free PE / Size         25345 / 99.00 GiB
```

### **DX3/DX4**

#### **Volume Group:**

```
VG Name                vg00
VG Size                 278.38 GiB
PE Size                 4.00 MiB
Total PE                71266
Alloc PE / Size        16995 / 66.39 GiB
Free PE / Size         54271 / 212.00 MiB
```

**Appendix F**  
**NWS/AWIPS Security Policy**

## Appendix F. NWS/AWIPS Security Policy

### Table of Contents

		<i>Page</i>
F.0	Introduction.....	1
	F.0.1 Purpose.....	1
	F.0.2 Scope.....	2
	F.0.3 Applicable Documents.....	2
	F.0.4 Changes to AWIPS IT Security Policy .....	3
F.1	Policy .....	3
F.2	Responsibilities .....	4
	F.2.1 IT System Owner .....	4
	F.2.2 AWIPS ISSO .....	4
	F.2.3 NWS SISSO.....	5
	F.2.4 Site AWIPS ISSO .....	6
	F.2.5 AWIPS System Administrator.....	7
	F.2.6 Operational Shift Team Leaders .....	7
	F.2.7 NCF.....	8
	F.2.8 NWSTC.....	8
	F.2.9 NWS Employees, Non-NWS Government Employees, Non-Government Contractor/Vendor Personnel.....	8
F.3	Allowed Use of AWIPS.....	8
	F.3.1 Access Control.....	9
	F.3.1.1 Discretionary Access Control (DAC) and Access Control Lists (ACL).....	9
	F.3.1.2 Awareness and Password Administration.....	9
	F.3.1.2.1 Awareness.....	10
	F.3.1.2.2 AWIPS Password Administration.....	10
	F.3.2 Use of Non-AWIPS Software on AWIPS Equipment.....	11
	F.3.3 AWIPS Network Security.....	11
	F.3.3.1 Network Operation and Routing Policy.....	11
	F.3.3.2 Interfaces with Untrusted Networks .....	12
	F.3.3.3 Services.....	13
	F.3.3.4 Firewall Rule Set.....	13
	F.3.3.5 AWIPS LAN Connections to Non-AWIPS Systems.....	14
	F.3.3.6 AWIPS IP Address Space Management .....	15
	F.3.3.7 Dial-in and Dial-out Access.....	15
	F.3.3.7.1 Restricted LDAD Access .....	15



	F.3.3.7.2	Restricted Dial-in Access.....	15
	F.3.3.7.3	Hardware Controls for Restricted Dial-in Access .....	15
	F.3.3.7.4	Restricted Dial-out Access.....	16
	F.3.4	Processing and Handling Classified Information in AWIPS.....	16
	F.3.5	Handling and Storage of AWIPS Magnetic or Storage Media .....	16
	F.3.6	Copyrighted AWIPS Software Control .....	16
	F.3.7	AWIPS Site Telecommunications .....	17
F.4		Implementation of the AWIPS Security Policy .....	17
	F.4.1	Responding to a Security Incident .....	17
	F.4.2	Policy Interpretation and Revision.....	18
	F.4.3	Policy Distribution.....	18
F.5		Security Patch Management .....	18

*This appendix is in accordance with the NWS/AWIPS NOAA8107 System Security Plan (SSP) (dated May 12, 2010), NWS Information Technology Directive (<http://www.nws.noaa.gov/directives/sym/pd06007002curr.pdf>), and NOAA Common Controls (<https://www.csp.noaa.gov/noaa/security-program/CandA/NOAACCC-201004/Common Controls Documentation/NOAA Common Controls v4 1 2010 04 07.doc>). The SSP was developed in accordance with NIST SP 800-18, Rev-1 and NIST SP 800-53, Rev-3, the NOAA Information Technology Security Manual (ITSM) and Department of Commerce (DOC) IT Security Program Policy (ITSPP), which are web-accessible: <https://www.csp.noaa.gov/>.*

*Any updates or changes to the policy and procedures trigger a notification that is sent to the person or persons with security responsibility throughout NOAA via hardcopy distribution as outlined in NOAA Administrative Order (NAO) 212-13 Section 6.04. All policy and procedures have been reviewed and are consistent with all applicable laws, Executive Orders, directives, policies, regulations, standards, and guidance.*

*The SSP is a living document that is changed as required to reflect system, operational, or organizational changes. The information in this appendix represents the most current policy received to date from the NWS by the Contractor. No changes will be made by the Contractor except for format purposes and the Contractor will only update this section as directed by the Government.*

## **F.0 Introduction**

The DOC, NOAA, and NWS are strongly committed to Information Technology (IT) Security. Senior leaders recognize that security must be inherent in our business processes and IT systems. Managers systematically recognize and address information security risks and take steps to understand and manage these risks. Information Technology (IT) systems security for AWIPS presents a constant challenge which must be met at every level of use and management. While various external threats exist, such as: hacker break-ins, terrorist attacks, and malicious intentions, the true risks to security come from poorly configured controls of software and hardware and users/administrators of the system not following the rules set forth in policy.

Use of technology alone, e.g., firewalls and robust operating system software, will not eliminate vulnerabilities in system security. In fact, firewalls can give users a false sense of security leading them to wrongly believe that they no longer need to be personally responsible for following security guidelines. The security of the entire system depends on each user's individual awareness of and commitment to security policy and procedures. Users and administrators must always be aware of the implications of their actions to the security of the system.

### **F.0.1 Purpose**

This document refers to a comprehensive IT Systems policy for the AWIPS. The high-level security policy delineates the allowed use of AWIPS and the general approach for applying the AWIPS security policy. It provides guidance to all personnel operating or servicing AWIPS hardware, software, or networks, including contract personnel, and specifies services and access controls for all AWIPS equipment. In addition, this

document references guidance for the implementation, maintenance, and monitoring of the AWIPS Security Policy.

### ***F.0.2 Scope***

This document references the controls, rules, roles, and responsibilities necessary for a viable IT systems security program. It does not specify in detail the procedures, technologies, or specific systems needed to implement the policy. These details are provided in separate documents. The scope of this policy includes:

- All of AWIPS;
- Other systems and equipment interfaced to AWIPS, as covered by this policy;
- All National Weather Service (NWS) and contractor personnel who use, operate, or service AWIPS hardware, software, or networks.

### ***F.0.3 Applicable Documents***

- E Government Act (Public Law 107-347), Title III, Federal Information Security Management Act (FISMA) dated December 2002;
- Office of Management and Budget (OMB) Circular A-130 Appendix III, Security of Federal Automated Information Resources dated November 2000;
- FIPS PUB 199, Standards for Security Categorization of Federal Information and Information Systems dated February 2004;
- FIPS PUB 200, Minimum Security Controls for Federal Systems dated March 2006;
- FIPS PUB 201-1, Personal Identity Verification for Federal Employees and Contractors dated March 2006;
- NIST SP 800-16, Information Technology Security Training Requirements: A Role and Performance Based Model dated April 1998;
- NIST SP 800-18 Revision 1, Guide for Developing Security Plans for Federal Information Systems dated February 2006;
- NIST SP 800-26 Revision 1, Guide for Information Security Program Assessments and System Reporting Form dated August 2005;
- NIST SP 800-30, Risk Management Guide for Information Technology Systems dated July 2002;
- NIST SP 800-34, Contingency Planning Guide for Information Technology Systems dated June 2002;
- NIST SP 800-37, Guide for the Security Certification and Accreditation of Federal Information Systems dated May 2004;
- NIST SP 800-47, Security Guide for Interconnecting Information Technology Systems dated August 2002;
- NIST SP 800-50, Building an Information Technology Security Awareness and Training Program dated October 2003;

- NIST SP 800-53A, Recommended Security Controls for Federal Information Systems dated February 2005;
- NIST SP 800-53 Revision 3, Recommended Security Controls for Federal Information Systems dated July 2009;
- NIST SP 800-60 Version 2, Volume I, Guide for Mapping Types of Information and Information Systems to Security Categories and Volume II, Appendixes dated June 2004;
- NIST SP 800-64 Revision 1, Security Considerations in the Information System Development Life Cycle dated June 2004;
- Department of Commerce (DOC) IT Security Program Policy and Minimum Implementation Standards (ITSPP), Revised January 2009;
- Department of Commerce (DOC) IT Security Program Policy and Minimum Implementation Standards, Revised June 30, 2005
- National Oceanic and Atmospheric Administration (NOAA) Common Controls Version 2.0, March 1, 2009
- National Oceanic and Atmospheric Administration (NOAA) IT Security Manual 212-1302, Version 4.2, March 31, 2008

#### ***F.0.4 Changes to AWIPS IT Security Policy***

Proposed changes to the AWIPS IT Security Policy may be submitted to the Weather Service Headquarters (WSH) AWIPS Information Technology System Security Officer (ISSO). The AWIPS ISSO will disseminate the proposed change to the AWIPS IT Security Focal Points for review and approval. If approved, it will be submitted to AWIPS management for final review and approval. When approved by Management, the change will be incorporated into the policy.

#### ***F.1 Policy***

AWIPS is critical to the ability of the NWS to accomplish its primary mission of protecting life and property. AWIPS systems will have levels of control consistent with DOC, NOAA, and NWS policy. The objectives of this policy are to:

- Prevent denial of service. Unauthorized access to the AWIPS computers or networks can cause degradation in or loss of the system's operational availability or performance. Tampering with software or hardware can result in loss of data, compromised product integrity, or decreased performance of the entire AWIPS network.
- Preserve the integrity of the AWIPS system and data. Unauthorized changes to data or system configurations must be prevented in order to maintain the integrity of: weather data used to prepare forecast products, the forecast products themselves, and the effective dissemination of these products to the users.
- Protect confidentiality. AWIPS contains sensitive information that requires protection from unauthorized disclosure or dissemination. Examples of such information include, but are not limited to: proprietary data (e.g., lightning reports), NWS

products, sensitive system information, proprietary software, and information enabling access to internal/external computer systems.

## ***F.2 Responsibilities***

Responsibilities for NWS IT security starts at the Office of the Assistant Administrator, and flows down through management of all NWS organizations to individual users. AWIPS IT security responsibilities will comply with all provisions of the NWS Information Technology Security Policy. Responsibilities are defined by a role based approach and are derived from ownership as defined below.

### ***F.2.1 IT System Owner***

Ownership of information and/or processing IT resources may be assigned to an organization, NWS, or to a functional element within an organization, such as an installation, a position, or a specific individual such as an IT installation manager at the regional, office, center, or laboratory level. When ownership is assigned to an organization, the designated head of the organization shall be the IT system owner. The originator or creator of data or information who has the greatest functional interest and is the physical possessor of the IT resource shall be considered in the determination of IT system ownership. Each IT system owner shall:

- Determine the sensitivity of the IT resources for which there is a responsibility. (The IT system owner shall periodically reevaluate previously specified levels of sensitivity and protection.)
- Determine the level of security which is consistent with appropriate directives and ensure that this level of protection is maintained on those IT resources.
- Complete all required certification actions.
- Designate an individual to serve as the Information System Security Officer (ISSO) with responsibility to develop, implement and manage the security of the IT system. (At the regional, office, center, or laboratory levels, there is a local Information System Security Officer that may serve as the local focal point for ISSO issues.

### ***F.2.2 AWIPS ISSO***

The AWIPS ISSO is responsible for the direct management of the AWIPS IT systems security program. The AWIPS ISSO requires adequate support staff and budget to accomplish all AWIPS specific security tasks. The AWIPS ISSO will be responsible for ensuring AWIPS compliance with requirements of higher level policies and will:

- Manage IT security for the AWIPS Network Control Facility (NCF) and the AWIPS terrestrial Wide Area Network (WAN).
- Approve security policy, plans, procedures, technologies, mechanisms, and devices for AWIPS.
- Manage Security scans and ensure that patches are implemented for the next OB release to fix identified vulnerabilities in the software/hardware.

- Manage all AWIPS Internet Protocol (IP) address space.
- Approve security alerts, patches, and bug fixes for AWIPS systems.
- Manage and track vulnerabilities identified during Accreditation and Continuous Monitoring of system security controls. .
- Manage all WSH AWIPS firewall systems.
- Research and recommend security technologies, mechanisms, devices, and systems for the AWIPS program.
- Assign and approve IP addresses for AWIPS IP address space requests, as appropriate, and maintain the AWIPS IP address data base.
- Maintain liaison with incident response teams from other security organizations.
- Review and implement as directed approved security alerts, patches, and bug fixes required for AWIPS.
- Monitor and ensure the security of all interfaces between AWIPS and external systems.
- Manage the development of AWIPS system-wide security plans, policies, and procedures.
- Develop a review mechanism for AWIPS audit trails which ensures the timely detection of and response to AWIPS security incidents.
- Coordinate development of IT systems security and awareness training for AWIPS System Administrators and users with the NWS Training Center (NWSTC).
- Provide assistance to AWIPS System Administrators and ISSOs on AWIPS IT systems security matters.
- Develop security validation and inspection criteria.
- Review and coordinate physical security requirements for all AWIPS sites.

### ***F.2.3 NWS SISSO***

Each Regional ISSO will be responsible for AWIPS IT systems security throughout the region. [The Information Technology Security Officer is the departmental level security officer, i.e., Jeremiah Dewey is the ITSO for OST.] The Regional ISSO will be responsible for all requirements of this and higher level security policies and will:

- Ensure the security of all interfaces between AWIPS and external systems in the region.
- Develop regional security policy, plans, and procedures.
- Evaluate and review security technologies, mechanisms, devices, and systems for all regional sites and recommend changes to the AWIPS ISSO. [The NWS security officer is the Senior Information System Security Officer (SISSO) Robert McKinney.]
- Review, respond to, and report security incidents and maintain logs and records associated with these incidents.
- Maintain liaison with security incident response teams in other regions.

- Issue approved security alerts, patches, and bug fixes to the AWIPS site ISSO's and monitor completion of the same.
- Develop and coordinate regional IT systems security training and awareness programs for AWIPS Administrators and users, and provide assistance to AWIPS field sites on IT systems security matters.
- Manage the AWIPS Local Data Acquisition and Dissemination (LDAD) firewalls consistent with this and higher level policy and procedures. Any requested changes to the configuration of the LDAD firewall will be approved by the Regional ISSO and reported to the AWIPS ISSO. Current records of configuration, including changes, for all firewalls will be maintained.
- Notify the AWIPS ISSO of unusual system activity reported by field sites and actions/support required to mitigate any attempted or successful breach of security.
- Monitor and review physical security policy, practices, and procedures for all regional AWIPS sites.

#### ***F.2.4 Site AWIPS ISSO***

The overall security of AWIPS at each site is the responsibility of that site's manager or system owner as described above. Contractor sites on the autonomous network will be the responsibility of the WSH AWIPS ISSO and prime contractor consistent with this policy and will apply retroactively from the date of this policy. All future contracts for AWIPS will contain the provisions of this policy.

The day-to-day security operations at each AWIPS site are critical to, and provide the basis for the success of the IT systems security program. The name of the ISSO appointed at each site will be provided to the NWS AWIPS ISSO through the Regional ISSO, if applicable. When possible, the Site ISSO should be someone other than the System Administrator. The Site ISSO is responsible for the local management and oversight for the system security. The Site ISSO will ensure compliance with this and higher level policies [The system level security is now the Information System Security Officer (ISSO)] and will:

- Develop local policy, plans and procedures, commensurate with guidance, or required local enhancements to existing policy, plans and procedures.
- Perform special AWIPS IT system reviews after a security incident, and archive all logs and records associated with the event.
- Notify the site manager and the Regional ISSO of any unusual or unexplained activity on the AWIPS system, and prepare incident reports when required (Local procedures will provide after-hours guidance for shift team leaders to respond to security incidents).
- Ensure the implementation of alerts, patches, and bug fixes.
- Ensure only approved software and hardware are integrated into AWIPS.
- Ensure local procedures and station duty manuals provide instructions for incident reporting, site access requirements, personal security-related information, and

- information on the release of site- specific sensitive information (e.g., what it is, what the release policy is, who has access, etc.).
- Brief new employees on IT security awareness and training as part of the Entry-on-Duty process.
  - Evaluate all IT and automated data processing (ADP) positions for sensitivity level regardless of classified data access.

### ***F.2.5 AWIPS System Administrator***

The individual site System Administrators (SAs) perform the majority of the administrative work supporting the local security managers. A strong link exists between the individual responsible for security and the program manager. The site System Administrator will:

- Configure site AWIPS resources commensurate with policies and procedures including: adding, configuring, and removing user accounts; managing system resources; and ensuring compliance with security policy, plans and procedures.
- Perform regularly scheduled analysis of system generated logs as well as special reviews after an unanticipated event and provide, as required, reports to the site ISSO and manager.
- Assist Site ISSO in the development of local policy, plans, and procedures.
- Notify the site manager, Site ISSO and Regional ISSO of any unusual activity on the system and prepare incident reports when required.
- Apply alerts, patches, and bug fixes as required.
- Implement approved software and hardware changes to AWIPS.
- Maintain system logon warning banners.
- Immediately notify the AWIPS NCF of breaches in security and ensure mitigation of security problems.

### ***F.2.6 Operational Shift Team Leaders***

Shift team leaders at operational sites may be required to respond to a security incident. The team leaders, in the absence of the local ISSO or System Administrator, will be responsible for reporting the incident to the NCF. The following guidance will be followed.

- Team leaders will report unexplained, significantly decreased performance, access by unknown persons or sites, corruption of data and/or products, unexplained changes to AWIPS software or hardware configuration, and any other perceived breach of security.
- During regular office work hours (0800 - 1600), all incidents will be reported to the site ISSO or Systems Administrator.
- All after-hours incidents will be reported to the NCF for processing and resolution.



### ***F.2.7 NCF***

The support mission of the NCF requires that it respond to all reported AWIPS security events. Should a site experience and/or report a perceived breach of security the NCF will, in coordination with the AWIPS Security Manager, take all required steps to mitigate the problem and return the site to a secure, fully operational state. Notifications and incident reports after hours, including archival of records and logs, is the responsibility of the NCF.

### ***F.2.8 NWSTC***

The NWSTC will be responsible for developing security training modules. They will provide security awareness training to AWIPS users during operational training and AWIPS System Security training to System Administrators and ISSOs, as required.

### ***F.2.9 NWS Employees, Non-NWS Government Employees, Non-Government Contractor/Vendor Personnel***

Awareness of and concern for security by all AWIPS users provides the baseline from which security can be maintained. Efforts to secure a system will fail without full cooperation and compliance from users. Each AWIPS user will:

- Be responsible for the security of his or her account. Users must protect their account access information and will not share their access information with any other user.
- Read this policy and acknowledge via signature they have read and understand the policy.
- Ensure their actions do not violate the security policy regardless of the security mechanisms in place.
- Report to the AWIPS Site ISSO or the local team leader any perceived breach of security, misuse of AWIPS systems or critical support equipment and systems, unusual requests for access to AWIPS systems accounts and or physical equipment, and any unexplained system difficulties.

### ***F.3 Allowed Use of AWIPS***

AWIPS may be used by authorized personnel to support the NWS mission, including forecast and warning operations, training, and/or research and development. User awareness and training, combined with stringent password controls minimize most security risks. Unauthorized user actions leading to disruption or degradation of AWIPS service are prohibited and may be punishable by fine, imprisonment, separation, or administrative consequences. Such actions include, but are not limited to:

- Unauthorized changes to system hardware or software configuration.
- Unauthorized access to AWIPS IT systems or support systems.
- Physical security breaches.

- Actions causing impairment of the AWIPS Network (This type of action may cause an affected site to be disconnected from the WAN pending determination of source and mitigation of problem.)

### ***F.3.1 Access Control***

In security vernacular, Discretionary Access Control (DAC) is the level of control applied to files and resources users may access on a system at a given time. These controls provide internal protection of data at the file level and control how, who and what type of access given files or applications have at a given site. Access Control Lists (ACL) are a means of restricting access to; a network segment, protocol, resource or node. ACL's can determine who is allowed to see the network, what protocol the network will pass to what device, or enhanced access control to DAC's for servers.

#### ***F.3.1.1 Discretionary Access Control (DAC) and Access Control Lists (ACL)***

DAC's and ACL's provide layered protection for sensitive data and resources in AWIPS. DACs in AWIPS have design implications. These controls when changed or enhanced at a site will not affect operation of the system as designed. These controls utilized beyond AWIPS baseline will be used at the discretion of system owners at all sites based on need. Department of Defense Instruction 8510.01 provides a guide for ISSO's use in determining local requirements. Each individual site will consider the totality of the IT systems located, used and controlled specifically at that site as a trusted system or resource for the members of that organization. Minimum security levels will be prescribed by the site ISSO and Manager and implemented by the systems administrator.

ACL's may be used and implemented at the local level as required and are embedded in the established baseline configuration for AWIPS. Primary ACL's are derived from network design and security requirements and are implemented by the Network Control Facility. DAC/ACL security mechanisms provide enhanced security to hardware and software resources used in many different ways in AWIPS. Ultimately however, the end goal is the protection of various types of data. Data security for the NWS is required for proprietary data, personnel data, personal data, military/DOD mission support data/products, operational support data/products, copyrighted software and other data peculiar to a site or organization. All of these data are considered sensitive and will meet the requirements established for data security in the National Weather Service, Information Technology Security Policy.

#### ***F.3.1.2 Awareness and Password Administration***

AWIPS operational readiness and a site's capability to provide the public with timely warning and forecast products requires continual awareness of system vulnerabilities. Vulnerabilities to a site are multifaceted and may include: physical security vulnerabilities (e.g., unsecured access to communications or environmental controls and hardware, natural phenomena such as hurricanes), collateral equipment vulnerabilities (e.g., unsecured access to computer controlled phone systems, backup power equipment or other critical non-AWIPS mission support equipment), or system specific vulnerabilities (e.g., security hole in the hardware networking infrastructure). Most

vulnerabilities can be controlled through a consistently-applied awareness of security requirements and compliance with published policy.

#### ***F.3.1.2.1 Awareness***

Site managers, ISSOs and systems administrators will designate which local data is sensitive, determine site physical security and significant collateral equipment security requirements, and review other site-specific security requirements. These local security requirements will be assessed and, as required, policy enhancements will be attached to the AWIPS IT Security Policy. All sites will require authorized AWIPS users to sign a statement of agreement stipulating security policies and procedures have been read and are understood by the employee prior to activation of individual accounts or use of AWIPS assets. **Attachment 4** provides a sample form that may be used.

#### ***F.3.1.2.2 AWIPS Password Administration***

Passwords provide the foundation for AWIPS security. The minimum rules for password use in AWIPS systems follow.

- Root and other system accounts, including the system administrator accounts, are considered sensitive.
- Immediately after completion of site installation activities and departure of the installation team, the local System Administrator will change all *awipsusr* and *textdemo* account passwords.
- Access to accounts on all servers and workstations will be strictly controlled at each site. The AWIPS System Administrator and local office Manager or their designee will maintain passwords for the sensitive local accounts in a secure place on station. All requirements for site accounts or access to sensitive accounts are subject to owner approval and configuration. For 24 hour maintenance support the Network Control Facility will be advised of any and all changes to root account passwords. Any and all access to AWIPS servers and workstations can only be granted by the owner or the maintaining unit.
- Password lists to all accounts on every piece of password-protected equipment associated in any way with AWIPS will be kept in a secure place and strictly controlled.

**NOTE:** A protected file on ADP equipment is not considered secure for this purpose.

- Any unauthorized access to password lists or compromise of passwords on the list will require an immediate change of all affected or compromised passwords.
- The NCF and AWIPS Security Manager will be responsible for, and hold complete control of the passwords for all network specific systems such as routers, hubs, communications processors and ancillary password-protected equipment.
- Passwords for restricted accounts will be set to expire every 6 months. All other requirements specified in Engineering Handbook (EHB)-13 shall be adhered to.

Password expiration for all other users should follow the guidelines established in EHB 13.

- Users are responsible for maintaining and securing their individual account passwords consistent with this policy and local guidance.
- Accounts of users who no longer require access to an AWIPS system on the AWIPS network shall be removed as soon as possible. Accounts of Government or contractor employees who have been reassigned, transferred, or terminated, shall be removed at the earliest practical time. Use of account expiration dates is required to ensure a regular review of the continued need for access.
- All individual users will be assigned a unique user ID and password; sharing of accounts is not permitted. The use of “generic” guest or service accounts to gain host access is not allowed. Except where needed to run specific software packages (e.g., the `awipsusr` or `fxa` account), group accounts are not authorized.

### ***F.3.2 Use of Non-AWIPS Software on AWIPS Equipment***

All sites will have an applications program manager for locally developed AWIPS applications. The applications manager will provide oversight to all local applications development, including full documentation and functional testing of such applications prior to installation. Extreme caution shall be exerted by local administrators when testing locally developed software on operational resources.

Operational degradation of local or national systems due to non-standard or poorly designed software being installed on operational AWIPS assets will constitute a security violation and must be reported in accordance with this policy.

Non-AWIPS software obtained from commercial sources, other Government agencies, Government contractors, or allied research institutions and locally-developed software may only be installed by the site AWIPS System Administrator or designee. Use of such software on AWIPS equipment must meet all of the following criteria:

- It is required to support the NWS mission.
- It does not interfere with the intended operational use of the system, or networking environment.
- The required approval for installation has been obtained.

### ***F.3.3 AWIPS Network Security***

The risk of Internet intrusion to AWIPS is significant. This policy supports the operational mission of the NWS field sites while providing for reasonable network isolation from the Internet through firewalls and authentication mechanisms.

#### ***F.3.3.1 Network Operation and Routing Policy***

In this policy the term “trusted network” refers to the AWIPS system and associated equipment that uses the designated AWIPS IP address space. Under no circumstance shall this address space be advertised to the Internet. Bridges, gateways or devices

connected to the Internet will not be connected to AWIPS except through the firewall. The trusted network has been designated as a unique “Autonomous System.” The flow and routing of information and data to different segments of the autonomous system, such as those managed by NWS National Centers, will be managed by the NCF as follows:

- For security purposes, only AWIPS-provided routers will be connected to the AWIPS site Local Area Networks (LANs). The AWIPS routers and hubs will be password protected. Router configuration will be centrally managed and controlled by the NCF and AWIPS Security Manager.
- No other IP network or sub-network shall be connected to the trusted network except by way of an approved firewall system as described in Chapter 4.3.2.
- TCP/IP is the standard protocol suite for the AWIPS network. Since LAN bandwidth is a critical factor in the AWIPS design, it must not be compromised by the use of “chatty,” non-standard, PC LAN protocol suites. Network devices that run other protocol suites, such as Novell SPX/IPX, AppleTalk, DECNET, NETbios, XNS, etc., shall not be connected to the AWIPS site LAN. The AWIPS routers will not route or bridge any data communication protocol suites other than TCP/IP over the AWIPS terrestrial WAN.
- The Message Handling System will be the primary vehicle for moving data and products over the WAN. Priority schemes ensuring this traffic receives top network resource priority will be used.

### *F.3.3.2 Interfaces with Untrusted Networks*

The trusted network may be connected to untrusted networks (i.e., external IP networks or sub-networks including those connected to the Internet) through the approved AWIPS firewalls with prior written approval from the NWS AWIPS ISSO for all WSH and National Center firewalls or regional ISSO for field LDAD firewalls. The following are the conditions for connection to and requirements for firewalls in AWIPS:

- These systems will provide an authentication system for all outside-in connections to AWIPS.
- Any requested connection must support NWS operations, research, and/or training needs.
- The requested connection must be accomplished in a manner that protects the AWIPS network from Internet intrusion.
- Required connections to the untrusted networks will be from the inside-out. Exceptions to this will only be as authorized using **Attachment 1 or 2** by the appropriate NWS AWIPS ISSO. Inconvenience will not be considered justification for outside in connections.
- All firewall systems will implement the monitoring, authentication, and access control mechanisms necessary to accommodate the AWIPS allowed-use policy.
- The WSH AWIPS firewall system will be administered by the AWIPS Security Manager, supporting staff, and other personnel approved by the NWS AWIPS ISSO.

- The AWIPS LDAD firewall systems will be configured by the site with the guidance of the Regional ISSO, and will be monitored and managed by the Regional ISSO and supporting staff. Other AWIPS LDAD firewall systems, such as those at NWSTC and National Centers, will be configured and managed by the site ISSO.
- Only the ISSO and AWIPS site System Administrators will have local accounts on the AWIPS firewall systems.
- Traveling lap-top and other home computers will not be used to access the AWIPS autonomous network unless explicitly allowed in writing by the NWS AWIPS ISSO. Lap-top or other computers used on the autonomous network will comply with all other requirements of this policy.

### *F.3.3.3 Services*

The following paragraphs describe the services authorized to be configured between the untrusted networks and the trusted network.

- Transfer of data between trusted and untrusted networks will be by means of File Transfer Protocol (**FTP**) or Remote Copy (**RCP**) as restricted by the rule set in Chapter 4.3.4 for all AWIPS firewalls.
- Administrative connectivity through the AWIPS firewalls shall be through **Telnet** only. X or Windows-related connectivity will not be passed across the firewall for any reason.
- Simple Network Management Protocol (**SNMP**) will be used from the inside-out to the extent required by the NCF to monitor LDAD functionality.
- Remote Shell (**RSH**) will be provided from the autonomous network to the LDAD server (inside-out) only as required to support the LDAD functionality.

### *F.3.3.4 Firewall Rule Set*

All AWIPS firewalls will comply with the following rule set. Deviation from these rules will only be via approval of the appropriate ISSO. All approved deviations will be reported to the NWS AWIPS ISSO. Networking configuration for the firewall will support the following AWIPS firewall rules.

- **FTP and Telnet Access to the Trusted Network from Untrusted Networks.** Firewalls shall be initially configured to disallow any connectivity from untrusted (outside-in) networks. Users requiring outside-in connectivity will request it using **Attachments 1 or 2**. Every effort will be made by approving ISSOs to facilitate user needs via inside-out connections. Users authorized by the appropriate authority, may have access to host computers on the trusted network from untrusted networks provided:
  - Such authorization is granted to individual users, not to organizations, networks or hosts.
  - The authorization is restricted to allow access to specific AWIPS host IP's from specific untrusted IP's.

- The firewall user authentication mechanism (proxy service) approved by the appropriate authority is implemented as part of the access process through the AWIPS firewall.
- Users are only allowed to use the firewall software's FTP and Telnet proxy services.
- **Firewall proxy services.** Use of the firewall proxy services is subject to restrictions imposed by the authorizing official and deemed necessary for the security of AWIPS.
- **RCP and RSH Access Between the Trusted Network and Untrusted Networks.** Firewalls shall be configured to allow RCP/RSH from the trusted network to the LDAD server only. This access is limited to the functionality provided by the AWIPS software utilization of the LDAD server. These services will not be configured for outside-in access nor will they be provided to any other system.
- **FTP and Telnet Access to the Untrusted Network from Trusted Networks.** Firewalls shall be configured to allow connectivity from the trusted networks (inside-out) to untrusted network resources. Inside-out connectivity shall be used for official purposes only. Any breach of this policy, such as the download of inappropriate data, constitutes a security violation and will be reported as a security incident.
- **SNMP Access to the Untrusted Network.** SNMP shall be configured and allowed to traverse the AWIPS firewall to the extent required by and supported in AWIPS for monitoring the LDAD server operation. The LDAD server will be the only authorized point for SNMP traffic outside the firewall.
- **All Other Access Between Trusted and Untrusted Networks.** In no case shall HTTP or X-Windows related traffic or access be allowed across any AWIPS firewall. These and other protocols may be approved by the NWS AWIPS ISSO on a case-by-case basis, provided that they are shown to be necessary to support the NWS mission or operations.

#### *F.3.3.5 AWIPS LAN Connections to Non-AWIPS Systems*

Non-AWIPS, NWS mission-support "trusted" IT systems with TCP/IP LAN interfaces (e.g., the NWS's Console Replacement System) may be interfaced to the AWIPS site LAN and become part of the trusted network, provided:

- They utilize AWIPS IP addresses designated for the trusted network.
- Their use complies with the AWIPS Security Policy and all applicable procedures and guidelines established by the AWIPS IT Security Policy.
- Their interface to the AWIPS LAN has been approved through normal NWS procedures.
- If a major system or new technology, an Interface Control Document for the interface between AWIPS and the trusted system has been written and approved prior to connecting the interface.

### ***F.3.3.6 AWIPS IP Address Space Management***

All AWIPS IP addresses will be managed and allocated by the AWIPS Security Manager and may be requested by filling out the IP Address Request Form (**Attachment 3**) and routing it, through appropriate levels, to the NWS AWIPS ISSO. Any single system required for administrative use or research and training may be installed in the trusted network space with approval of the NWS AWIPS ISSO (**Attachment 3**). This equipment will have the latest version of NWS supported virus software and all required security patches, updates, and bug fixes installed and will not use active daemons or hardware to allow other untrusted devices to connect to or through them to AWIPS. The local office will be responsible for ensuring protection of AWIPS resources from security vulnerabilities inherent to these types of systems.

### ***F.3.3.7 Dial-in and Dial-out Access***

Improperly configured dial-in or dial-out capabilities can create security vulnerabilities by providing unintended “back-door” access to the AWIPS network. For this reason dial-in and dialout access will be restricted to the provisions described in the following paragraphs.

#### ***F.3.3.7.1 Restricted LDAD Access***

AWIPS Site Managers may authorize individuals (such as Cooperative Users) and external computer systems and sensors to access the AWIPS LDAD servers. These “LDAD users” will not be allowed to access any AWIPS trusted network host computers, other AWIPS equipment, or facilities except those explicitly designated for LDAD use. All LDAD sites allowing login or BBS types of access to LDAD will ensure the appropriate Unix security actions are taken prior to these authorizations.

#### ***F.3.3.7.2 Restricted Dial-in Access***

Selected AWIPS users may be authorized by the NWS AWIPS ISSO or the applicable regional ISSO to have dial-in access to AWIPS networks, provided that such access is necessary to support AWIPS for NWS operations. Such authorization will be granted to individual users, not to organizations, computer systems, or networks. The authorization will be restricted to access specific AWIPS hosts and to specific time periods the ISSO deems necessary for the security of AWIPS. Such users may dial into the AWIPS networks using only the telephone numbers, modems, terminal servers, associated security equipment, and procedures approved by the respective ISSO.

#### ***F.3.3.7.3 Hardware Controls for Restricted Dial-in Access***

Each site manager will ensure modems used to perform maintenance and monitor and control functions during emergencies or any other modem, (except WAN backup circuits) with access or connection to the trusted AWIPS networks or equipment has a locally-installed hardware device which provides a disconnect for the phone lines to those modems when not in use. Procedures for connecting the lines via this device for emergency purposes shall be added to the local station duty manual and all personnel



shall be trained in its use and location. Prior to connecting this device by request from outside sources, steps shall be taken to validate the source of the request (e.g., call back authentication).

#### ***F.3.3.7.4 Restricted Dial-out Access***

All AWIPS dial-out services and equipment must conform to the guidelines established by the AWIPS System Manager's Manual. Extreme care must be taken to prevent the misuse of dial-out modems that would permit unauthorized access into AWIPS from external networks. Use of dial-out modems to establish IP connections (e.g., using SLIP or PPP protocols) with external networks is not permitted.

#### ***F.3.4 Processing and Handling Classified Information in AWIPS***

The protection and transmission of classified information has varying degrees of requirements depending on the classification of the data. Classified information must not be processed on IT systems which do not have DOC/NOAA approval to do so. The NWS AWIPS ISSO has additional information concerning the processing and handling of classified information on NOAA IT systems.

#### ***F.3.5 Handling and Storage of AWIPS Magnetic or Storage Media***

Sensitive or classified data stored on portable media must be protected in a manner similar to the hard-copy equivalent. This will require the storage of backup or archived portable media in secure containers on and off site. Requirements for hard copy information security are explained in Department Administrative Order (DAO) 207-1, Security Programs, dated 24 June 1991. The NWS AWIPS ISSO has additional information concerning the handling and storage of portable storage media.

#### ***F.3.6 Copyrighted AWIPS Software Control***

Public Law 102-561 amends the Copyright Act, Title 18, United States Code, with respect to the criminal penalties for software copyright infringement. This law now makes certain acts Federal felonies with fines, imprisonment, or both as penalties. Criminal liability results when within a 180-day period at least 10 copies of a copyrighted work with a retail value in excess of \$2,500 have been reproduced or distributed. The act must also have been willful, for commercial advantage, or for private financial gain. Lesser acts of infringement remain a misdemeanor which is punishable by a fine. DOC policy against acts of copyright violation for software purchased by the DOC and its operating units is provided in Chapter 10.11 of the U.S. Department of Commerce Information Technology Management Handbook. All provision of this policy will apply to AWIPS and any software procured for AWIPS systems. Software is automatically protected by Federal copyright law from the moment of its creation. Under the Copyright Act, software developers have exclusive rights to reproduce their copyrighted work. Persons who purchase a copy of software only have the right to:

- Copy or install the software onto a single computer.

- Make another copy for archival purposes only.

When upgrades to software are purchased, the old version must either be destroyed or returned to the software developer. It is illegal to use the old software version on another computer. Upgraded software is usually purchased at a reduced cost and is considered a continuation of the original license and not an additional license. Each AWIPS site will ensure compliance with licensing agreements issued by the manufacturer for software purchased by the Government. Copies of original software, upgrades, and documentation shall be accounted for and retained.

### ***F.3.7 AWIPS Site Telecommunications***

The NWS AWIPS ISSO is responsible for recommending procedures and providing advice regarding adequate protection for the communications of sensitive information in accordance with the U.S. Department of Commerce Information Technology Security Manual. National security or classified information **must not** be discussed over or otherwise transmitted or processed by any form of telecommunications unless approved measures are taken to protect the information. Policies and specifications dealing with the security of Federal telecommunications are developed and issued under the purview of the National Security Council. These policies are stated in the U.S. Department of Commerce Information Technology Security Manual and the U.S. Department of Commerce National Security Information Manual.

## ***F.4 Implementation of the AWIPS Security Policy***

AWIPS Security is implemented in accordance with the SSP.

### ***F.4.1 Responding to a Security Incident***

A security incident is any event that could pose a threat to the integrity, availability, or confidentiality of AWIPS equipment, applications, or data. It is the responsibility of an affected site to report suspected security incidents to the NCF, AWIPS Security Manager and local or regional NWS AWIPS ISSO who in turn will report them as required by the National Weather Service, Information Technology Security Policy to the appropriate authority. The latest “**ADP Security Incident Report**” form, available at the NOAA security web site ([www.rdc.noaa.gov/~security/](http://www.rdc.noaa.gov/~security/)) shall be filled out by the System Administrator at the affected site and submitted. The NCF and AWIPS Security Manager, if required, will coordinate with the NOAA Telecommunications and ADP Security Branch and the affected site’s local or regional ISSO to determine the necessary course of action and provide higher-level reporting. Depending on the severity of the incident and the level of threat, the Federal Bureau of Investigation may become involved and actions may be taken leading to the apprehension and eventual prosecution of a violator. Since the availability of AWIPS is critical to the NWS mission to protect life and property, the highest possible response priority will be given to the restoration of service and the protection of the system from further attack.

#### ***F.4.2 Policy Interpretation and Revision***

Threats to computer security are constantly evolving. AWIPS also is evolving with the development of new software, hardware, techniques, operational procedures, and observation and dissemination systems. Because of these evolutionary changes, it is essential to regularly review and update the AWIPS Security Policy and related procedures. The NWS AWIPS ISSO will ensure that the policy is reviewed at least once a year and updated as needed.

#### ***F.4.3 Policy Distribution***

The AWIPS Security Policy will be distributed to all AWIPS system owners and support organizations. All AWIPS users will review the policy annually and sign a statement acknowledging their understanding of and agreement to abide by the AWIPS Security Policy. This agreement can be locally produced and will be maintained at each site.

#### ***F.5 Security Patch Management***

Security scans and patch procedures are in accordance with the Network Control Facility Security Patch Procedures, dated June 23, 2010, contained in the NCF Standard Operating Procedures (SOP), Appendix E, *Security Policies and Procedures*.

**Attachment 1**  
**Request for User Id and Password on**  
**The AWIPS WSH Firewall System**

Please fill out this form up through "Supervisor's Approval". Then send or fax the form to: Fax 301-713-0173  
 AWIPS Security Manager, NOAA NWS SSMC2, Rm 15404, 1325 East West Hwy, Silver Spring, MD 20910.

Note: This request assumes that the requester already has obtained a valid user account on an AWIPS System and needs to access his/her account from a system that is not connected to the AWIPS LAN or WAN (e.g., access from a workstation connected to an untrusted network such as a Local LAN/WAN or INTERNET).

**Name of Requester, organization, and code:**

**Phone Number & cmail or email address:**

**Justification, use and destination:** State why and where if not on dsl at your site you need to access your account on AWIPS from a system that is not connected to the AWIPS LAN or WAN and describe your use, e.g., transfer files via FTP, run Telnet session for ....., etc.).

**Indicate the IP address and domain name of the workstation or PC on INTERNET that you wish to use to communicate with the AWIPS WSH Firewall System and a preferred username of six characters.**

I have read the AWIPS Security Policy and agree to abide by that policy.

I will not disclose my user ID and password to other persons.

Requested by:

\_\_\_\_\_  
 Signed Date

Supervisor's approval:

\_\_\_\_\_  
 Signed Date

Security Officer Approval to establish  
 user access to AWIPS firewall system:

\_\_\_\_\_  
 Signed Date

User access to AWIPS firewall system  
 established:

\_\_\_\_\_  
 Signed Date

**Attachment 2**  
**Request for User Id and Password in the**  
**AWIPS LDAD Firewall System**

Please fill out this form up through "Supervisor's Approval". Then send or fax the form to: Regional ISSO, with a cc: to: AWIPS Security Manager, NOAA NWS SSMC2, Rm 15404, 1325 East West Hwy, Silver Spring, MD 20910.

**Note:** This request assumes that the requester already has obtained a valid user account on an AWIPS System and needs to access his/her account from a system that is not connected to the AWIPS LAN or WAN. (e.g., access from a workstation connected to an untrusted network such as a local LAN or INTERNET.)

**Name of Requester, organization, and code:**

**Phone Number & cmail or email address:**

**Justification and use:** State why you need to access your account on AWIPS via FTP or Telnet from a system that is not connected to the AWIPS LAN or WAN and describe your use, e.g., transfer files via FTP, run Telnet session to access data, etc.

**Indicate the IP addresses of each workstation or PC on INTERNET that you wish to use to communicate with the AWIPS LDAD Firewall System:**

I have read the AWIPS Security Policy and agree to abide by that policy.  
 I will not disclose my user ID and password to other persons.

Requested By:

\_\_\_\_\_  
 Signed Date

Supervisor's approval:

\_\_\_\_\_  
 Signed Date

Regional Approval to establish user  
 access to AWIPS LDAD firewall system:

\_\_\_\_\_  
 Signed Date

User access to LDAD firewall  
 system established:

\_\_\_\_\_  
 Signed Date

### Attachment 3 Request for AWIPS IP Address

Please fill out this form up through "Supervisor's Approval". Then send or fax the form to: Fax 301-713-0173 or AWIPS NWS ISSO, NOAA NWS SSMC2 Rm 15426, 1325 East West Hwy, Silver Spring MD 20910, via the regional ISSO, with a copy to the NCF.

Name of Requester: \_\_\_\_\_

Organization: \_\_\_\_\_

Telephone Number: \_\_\_\_\_

Proposed Workstation/PC name: \_\_\_\_\_

Machine Type/Operating System: \_\_\_\_\_

System Administrator: \_\_\_\_\_

Justification (Please state what work will be performed on this workstation/PC, and how it relates to the AWIPS system):

Primary Network Applications To Be Utilized (e.g., TELNET, FTP, etc):

I certify that the above stated workstation/PC complies with applicable NOAA UNIX security recommendations, is compliant with AWIPS security policy, and poses minimal risk to the security of the AWIPS system. I understand that the NCF reserves the right to filter any IP traffic that is generated by the above-named device which may be degrading the operational site AWIPS equipment or degrading the operation of the AWIPS Terrestrial Network (ATN).

Requested by:

\_\_\_\_\_  
Signed Date

NWS Supervisor's Approval:

\_\_\_\_\_  
Signed Date

Regional Approval:

\_\_\_\_\_  
Signed Date

AWIPS NWS ISSO:

\_\_\_\_\_  
Signed Date

ASSIGNED IP ADDRESS:

### **Attachment 4 User Acknowledgment**

As a user of the AWIPS system, I acknowledge my responsibilities to conform to the following requirements and conditions established by the AWIPS Security Policy.

1. I understand that failure to sign this acknowledgment will result in denial of access to the AWIPS system.
2. I understand the need to protect system and individual passwords. I will not share my accounts or passwords. I understand that I am responsible for all actions taken using my accounts. I understand my responsibility to appropriately protect all output generated by me on AWIPS (including printed output, magnetic tapes, floppy diskettes, and downloaded hard disk files) and to properly label all media.
3. I understand my responsibility to report any/all systems or network problems to the system administrator. I will not install, modify, or remove any hardware or software without the permission of the system administrator.
4. I will not induce or process data which the network is not specifically authorized to handle. I acknowledge my responsibility to use the AWIPS system/network only for official NWS business.
5. I understand my use of AWIPS systems/networks is subject to monitoring to ensure proper functioning, to protect against improper or unauthorized use or access, and to verify the presence or performance of applicable security features or procedures. By using the AWIPS system, I grant consent to such monitoring.
6. I will protect my equipment by keeping food, drink, and electrical appliances away from AWIPS resources I use or maintain.
7. I will protect my work area by politely challenging and assisting people who do not belong in the area.
8. I understand my responsibility to backup data as required by local policy and procedures.
9. I acknowledge my responsibility to conform to the requirements of this document and the AWIPS Security Policy when using or maintaining any AWIPS information systems or networks. I also acknowledge that failure to comply with these requirements and conditions may constitute a security violation resulting in denial of access to AWIPS information systems, networks, or facilities and further action as deemed appropriate.

Signature \_\_\_\_\_ Date \_\_\_\_\_

**Appendix G**  
**AWIPS Password Management Policy**



CITR-021, “Password Management,” published by the U.S. Department of Commerce on September 21, 2012, reflects current DOC policy on Password Management.

Note: Please remember that it only covers passwords and does not address compliance with HSPD-12 authentication.

To view the criteria for setting up acceptable passwords, see Section 3.1, General Guidance on Individual User Accounts, of this System Manager’s Manual.

**Appendix H**  
**SBN Products for WAN Transmission**  
**During an SBN Failure**

## **Appendix H. SBN Products for WAN Transmission During an SBN Failure**

### **Table of Contents**

	<i>Page</i>
H.1 Transmitted SBN Products .....	1
H.2 Current Address Lists.....	1

Certain SBN products will be transmitted over the WAN in the event of an SBN failure. The current list of those SBN products is provided in this appendix.

### H.1 Transmitted SBN Products

The file, `/awips/ops/data/wanbu_prodtbl.nmc`, resides on dx1. It contains the default address lists, which consist of the product IDs and the default attributes, in the following format:

```
"<prodID>" |<sitelist>|<priority>|<valid_time>
```

**Note:** <prodID> must be in quotes, as shown.

Example:

```

"^YH[IJ][A-K](99|85|70|50|40|30|20|15|10) KWBC" |ALL
  ○   where
      <prodID> is "^YH[IJ][A-K](99|85|70|50|40|30|20|15|10) KWBC"
      <sitelist> is ALL
      <priority> and <valid_time> are not specified for these products

```

### H.2 Current Address Lists

The current file default address lists follow. Note that <prodID> and <sitelist> (= ALL) are the only attributes currently specified for any of these products.

```

"^AB.* PGIW" |ALL
"^TP.* KGWC" |ALL
"^FZ.* KNHC" |ALL
"^FZ.* KNHC" |ALL
"^WS" |ALL
"^AX.* KNHC" |ALL
"^WT.* RJTD" |ALL
"^AB.* KNHC" |ALL
"^NOUS4. KNHC" |ALL
"^UR.* KNHC" |ALL
"^UZ.* KNHC" |ALL
"^ACPN.. PHFO" |ALL
"^ACPA.. PHFO" |ALL
"^TXUS20 " |ALL
"^TCUS" |ALL
"^SE" |ALL
"^WE" |ALL
"^FV" |ALL
"^WV" |ALL
"^FWUS" |ALL
"^WOXX" |ALL
"^NOUS.. KWNO" |ALL
"^NOUS.. KWBC" |ALL

#-----
# NC NWP Text
#-----
"^FOUS.. KWNO" |ALL

```



```

acqparms.sto
acqparms.uplink
acqparms.uplink_h0
acqparms.uplink_h0h1
acqparms.uplink_h1
acqparms.uplink_msg
acqparms.vrh
acq_send_parms.sbn
acq_wmo_file_parms.hazcollect
acq_wmo_file_parms.nwstg
acq_wmo_file_parms.nwvs
acq_wmo_file_parms.sbn
acq_wmo_parms.acr
acq_wmo_parms.afc
acq_wmo_parms.afg
acq_wmo_parms.ajk
acq_wmo_parms.gum
acq_wmo_parms.hfo
acq_wmo_parms.mfl
acq_wmo_parms.mlb
acq_wmo_parms.mtr
acq_wmo_parms.pbp
acq_wmo_parms.sbn
acq_wmo_parms.sbn.east
acq_wmo_parms.sbn.local
acq_wmo_parms.sbn.radar
acq_wmo_parms.sbn.west
acq_wmo_parms.sju
acq_wmo_parms.sto
acq_wmo_parms.tbw4
acq_wmo_parms.vrh
dxl-tbw3{sridharb}83: vi wanbu_prodtbl.nmc
"^AB.* PGIW" |ALL
"^TP.* KGWC" |ALL
"^FZ.* KNHC" |ALL
"^FZ.* KNHC" |ALL
"^WS" |ALL
"^AX.* KNHC" |ALL
"^WT.* RJTD" |ALL
"^AB.* KNHC" |ALL
"^NOUS4. KNHC" |ALL
"^UR.* KNHC" |ALL
"^UZ.* KNHC" |ALL
"^ACPN.. PHFO" |ALL
"^ACPA.. PHFO" |ALL
"^TXUS20 " |ALL
"^TCUS" |ALL
"^SE" |ALL
"^WE" |ALL
"^FV" |ALL
"^WV" |ALL
"^FWUS" |ALL
"^WOXX" |ALL
"^NOUS.. KWNO" |ALL
"^NOUS.. KWBC" |ALL

#-----
# NC NWP Text
#-----
"^FOUS.. KWNO" |ALL
"^FOUE.. KWNO" |ALL

```

"^FOUM.. KWNO"	ALL
"^FOUW.. KWNO"	ALL
"^FOCA.. KWNO"	ALL
"^FOHW.. KWNO"	ALL
"^FEX.* KWBC"	ALL
"^FOPA.. KWNO"	ALL
"^FOUS.. KWNO"	ALL
"^FOAK.. KWNO"	ALL
"^FOUS.. KWNO"	ALL
"^FOUE.. KWNO"	ALL
"^FOUM.. KWNO"	ALL
"^FOUW.. KWNO"	ALL
"^FOAK.. KWNO"	ALL
"^FOUS50 KWNO"	ALL
"^FOX.* KWBC"	ALL
"^FEUS.. KWNO"	ALL
"^FEAK.. KWNO"	ALL
"^FEPA.. KWNO"	ALL
"^FDUS.. KWNO"	ALL
"^FDAK.. KWNO"	ALL
"^FDHW.. KWNO"	ALL
"^FDUE.. KWBC"	ALL
"^FDUM.. KWBC"	ALL
"^FDUW.. KWBC"	ALL
"^FDAK.. KWBC"	ALL
"^FDHW.. KWBC"	ALL
"^FBHW.. PHFO"	ALL
"^FQUS.. KWBC"	ALL
"^AG.* KWNO"	ALL

**Appendix I**  
**Administrative Tips for Monitoring**  
**System Performance**



## **Appendix I. Administrative Tips for Monitoring System Performance**

### **Table of Contents**

	<i>Page</i>
I.1 Check to See Where the Packages Are Running .....	1
I.2 Check for Mandatory Processes on DX1F.....	1
I.3 Check for Mandatory Processes on DX2F.....	8
I.4 Check for Mandatory Processes on DX3/DX4 .....	11
I.5 Check for Abnormal Processes on CP1F.....	15
I.6 Check for Abnormal Processes on CPSBN1/CPSBN2 .....	16
I.7 Check for Abnormal Processes on AX .....	17
I.8 Check for Mandatory Processes on PX1.....	17
I.9 Check for Mandatory Processes on PX2.....	19
I.10 Check for Mandatory Processes on REP Servers (RFCs only).....	22
I.11 Checklist for Servers and Workstations.....	22
I.11.1 Servers .....	22
I.11.2 All Machines.....	33

To monitor system performance, complete the following procedures in sequential order at least ONCE per day.

### I.1 *Check to See Where the Packages Are Running*

To verify that the Red Hat Cluster Manager swap packages have been enabled for the **px1apps**, **px2apps**, **dx1apps**, **dx2apps** swap packages, as user **root** on the respective servers,

**TYPE:**        **hb\_stat**

An example of dx1apps follows.

```
[root@dx1-tbw3 ~]# hb_stat
Heartbeat Status Monitor                               Jul 09 18:39:56
===== M e m b e r   S t a t u s =====
Member          Status      IP address
-----
dx1-tbw3        Up          165.92.24.1
dx2-tbw3        Up          165.92.24.2
===== S e r v i c e   S t a t u s =====
Service         IPaddr      Cronfile      Owner         Start Time
-----
a2dx1apps       165.92.24.65  a2dx1cron,a2SIT dx1-tbw3      2012-05-29 19:35:31
a2dx2apps       165.92.24.66  a2dx2cron,a2SIT dx2-tbw3      2012-05-29 19:26:37
```

### I.2 *Check for Mandatory Processes on DX1F*

Log in to the Linux data server running the **dx1apps** package (normally DX1F).

1. Check what is mounted on the server. Verify that the NAS is mounted.

**TYPE:**        **df -H**

- Look for **/data/fxa** and the percentage used. Percentages larger than 70 percent could indicate a problem. Notify the Network Control Facility if this is the case.
- Also look for any directories that appear to be filling up (88 percent or higher).

An example follows for RFC.

```
Filesystem                Size  Used Avail Use% Mounted on
/dev/mapper/vg01-lvol01  1.1G  670M  294M  70% /
tmpfs                     17G   0    17G   0% /dev/shm
/dev/mapper/vg01-lvol_fxa  5.1G  4.1G  731M  85% /awips/fxa
/dev/mapper/vg01-lvol_ifps 1.4G   69M  1.2G   6% /awips/ifps
```

/dev/mapper/vg01-lvol_ldad	1.1G	74M	890M	8%	/awips/ldad
/dev/mapper/vg01-lvol_ops	297M	66M	215M	24%	/awips/ops
/dev/mapper/vg01-lvol_awips2	34G	2.2G	30G	7%	/awips2
/dev/sde3	98M	63M	30M	69%	/boot
/dev/mapper/vg01-lvol_logs	11G	27M	9.9G	1%	/data/logs
/dev/mapper/vg01-lvol_tmp	1.1G	9.2M	954M	1%	/tmp
/dev/mapper/vg01-lvol_usr	11G	8.3G	1.4G	86%	/usr
/dev/mapper/vg01-lvol_var	3.6G	1.8G	1.6G	53%	/var
nasl:/awipsADAPT	1.1G	172M	902M	17%	/awips/adapt
nasl:/awipsDEV	4.3G	1.2M	4.3G	1%	/awips/dev
nasl:/awipsGFESuit	108G	26G	83G	24%	/awips/GFESuite
nasl:/awipsHYDRO	108G	54G	55G	50%	/awips/hydroapps
nasl:/dataLOCAL	162G	26G	136G	16%	/data/local
nasl:/dataX400	630M	13M	617M	2%	/data/x400
nasl:/DSshared	1.6G	217M	1.4G	14%	/DS_shared
nasl:/dataADAPT	3.3G	0	3.3G	0%	/data/adapt
nasl:/dataGFE	21M	0	21M	0%	/data/GFE
nasl:/awipsHOME	119G	37G	82G	31%	/home
nasl:/dataFXA	537G	376G	162G	70%	/data/fxa
nasl:/aiidata/utility	537G	261G	277G	49%	/awips2/edex/data/utility
nasl:/localapps	54G	21M	54G	1%	/localapps
nasl:/awips2REPO	43G	7.2G	36G	17%	/data/fxa/INSTALL/awips2
/dev/mapper/vg_aaidb-awipsiidb	159G	57G	95G	38%	/awips2/data
nasl:/GFESuite2	11G	120M	11G	2%	/awips2/GFESuite

An example follows for WFO.

/dev/mapper/vg01-lvol01	1.1G	659M	321M	68%	/
tmpfs	17G	0	6.3G	0%	/dev/shm
/dev/mapper/vg01-lvol_fxa	5.2G	1.9G	3.1G	38%	/awips/fxa
/dev/mapper/vg01-lvol_ifps	1.4G	82M	1.2G	7%	/awips/ifps
/dev/mapper/vg01-lvol_ldad	1.1G	84M	897M	9%	/awips/ldad
/dev/mapper/vg01-lvol_ops	305M	183M	107M	64%	/awips/ops
/dev/mapper/vg01-lvol_awips2	34G	2.3G	30G	8%	/awips2
/dev/sde3	98M	63M	30M	69%	/boot
/dev/mapper/vg01-lvol_logs	11G	205M	9.9G	3%	/data/logs
/dev/mapper/vg01-lvol_tmp	1.1G	21M	959M	3%	/tmp
/dev/mapper/vg01-lvol_usr	11G	8.3G	1.6G	85%	/usr
/dev/mapper/vg01-lvol_var	3.6G	2.1G	1.4G	62%	/var
nasl:/awipsADAPT	1.1G	707M	367M	66%	/awips/adapt
nasl:/awipsDEV	4.3G	132k	4.3G	1%	/awips/dev
nasl:/awipsGFESuit	108G	18G	90G	17%	/awips/GFESuite

```

nas1:/awipsHYDRO          1.1T  4.0G  1.1T  1%
                        /awips/hydroapps
nas1:/dataLOCAL          162G   49G  113G  30% /data/local
nas1:/dataX400          630M  228M  402M  37% /data/x400
nas1:/DSshared          1.1G  410M  664M  39% /DS_shared
nas1:/dataADAPT          3.3G    0  3.3G   0% /data/adapt
nas1:/dataGFE            21M    0   21M   0% /data/GFE
nas1:/awipsHOME          119G   97G   22G  82% /home
nas1:/dataFXA           537G  391G  147G  73% /data/fxa
nas1:/aiidata/utility    537G   14G  524G   3%
                        /awips2/edex/data/utility
nas1:/localapps          54G   39M   54G   1% /localapps
nas2:/dataSTORE          2.2T   41G  2.2T   2% /data_store
nas2:/awips2ARCHIVE      3.3T   57G  3.3T   2% /archive
nas1:/awips2REPO         43G   6.3G  37G  15%
                        /data/fxa/INSTALL/awips2
nas1:/storage            537G  186G  352G  35% /awips/storage
/dev/mapper/vg_aaidb-awipsiadb 159G   18G  133G  12% /awips2/data
nas1:/GFESuite2         11G  204M   11G   2%
                        /awips2/GFESuite

```

Verify that the fxa processes listed below are running.

**TYPE:** `ps -wef |grep fxa`

An example follows.

```

awips      5714 22545  0 18:20 ?          00:00:03 postgres: awips
fxatext 165.92.24.3(50942) idle

awips      14392 22545  0 18:23 ?          00:00:00 postgres: awips
fxatext 165.92.24.4(36648) idle

awips      14393 22545  0 18:23 ?          00:00:00 postgres: awips
fxatext 165.92.24.4(36650) idle

awips      18169 22545  0 18:24 ?          00:00:00 postgres: awips
fxatext 165.92.24.4(36708) idle

awips      22662    1  0 Jun09 ?          00:20:31 /awips2/java/bin/java
-cp /awips2/rcm/data/config/res::/awips2/rcm/lib/activemq-broker-
5.12.1.jar:/awips2/rcm/lib/activemq-client-
5.12.1.jar:/awips2/rcm/lib/activemq-openwire-legacy-
5.12.1.jar:/awips2/rcm/lib/activemq-stomp-
5.12.1.jar:/awips2/rcm/lib/cglib-nodep-
2.1_3.jar:/awips2/rcm/lib/cglib-src-
2.1_3.jar:/awips2/rcm/lib/commons-beanutils-
1.8.3.jar:/awips2/rcm/lib/commons-codec-
1.10.jar:/awips2/rcm/lib/commons-codec-1.10-
sources.jar:/awips2/rcm/lib/commons-collections-
3.2.jar:/awips2/rcm/lib/commons-lang-2.6.jar:/awips2/rcm/lib/commons-
lang-2.6-
sources.jar:/awips2/rcm/lib/com.raytheon.uf.common.util.jar:/awips2/r
cm/lib/geronimo-j2ee-management_1.1_spec-

```

```

1.0.1.jar:/awips2/rcm/lib/geronimo-jms_1.1_spec-
1.1.1.jar:/awips2/rcm/lib/geronimo-jta_1.0.1B_spec-
1.0.1.jar:/awips2/rcm/lib/hawtbuf-1.11.jar:/awips2/rcm/lib/jbzip2-
0.9.1.jar:/awips2/rcm/lib/jcl-over-slf4j-
1.7.12.jar:/awips2/rcm/lib/jcl-over-slf4j-1.7.12-
sources.jar:/awips2/rcm/lib/jul-to-slf4j-
1.7.12.jar:/awips2/rcm/lib/jul-to-slf4j-1.7.12-
sources.jar:/awips2/rcm/lib/log4j-over-slf4j-
1.7.12.jar:/awips2/rcm/lib/log4j-over-slf4j-1.7.12-
sources.jar:/awips2/rcm/lib/logback-classic-
1.1.2.jar:/awips2/rcm/lib/logback-classic-1.1.2-
sources.jar:/awips2/rcm/lib/logback-core-
1.1.2.jar:/awips2/rcm/lib/logback-core-1.1.2-
sources.jar:/awips2/rcm/lib/qpidd-client-
0.32.jar:/awips2/rcm/lib/qpidd-common-0.32.jar:/awips2/rcm/lib/quartz-
1.8.6.jar:/awips2/rcm/lib/radarserver-mq.jar:/awips2/rcm/lib/slf4j-
api-1.7.12.jar:/awips2/rcm/lib/slf4j-api-1.7.12-
sources.jar:/awips2/rcm/lib/spring-beans-
4.1.6.RELEASE.jar:/awips2/rcm/lib/spring-beans-4.1.6.RELEASE-
sources.jar:/awips2/rcm/lib/spring-context-
4.1.6.RELEASE.jar:/awips2/rcm/lib/spring-context-4.1.6.RELEASE-
sources.jar:/awips2/rcm/lib/spring-context-support-
4.1.6.RELEASE.jar:/awips2/rcm/lib/spring-context-support-
4.1.6.RELEASE-sources.jar -
Dcom.raytheon.rcm.configDir=/awips2/rcm/data/config -
Dcom.raytheon.rcm.awips1.decompressRadarProducts=yes -
Dcom.raytheon.rcm.logDir=/awips2/rcm/data/logs -
Dlogback.configurationFile=logback.xml -Dqpidd.dest_syntax=BURL -
Dawips2_fxa=/awips2/fxa -
Dcom.raytheon.rcm.edexRadarEndpoint=/data_store/radar
com.raytheon.rcm.mqsrvr.MQServer

fxa      22884      1  0 Jun09 ?      00:00:00
/awips/fxa/bin/notificationServer

root     23169 22799  0 18:25 pts/3    00:00:00 grep fxa

fxa      23284      1  0 Jun09 ?      00:00:00
/awips/fxa/bin/MhsServer

fxa      23323      1  0 Jun09 ?      00:00:00
/awips/fxa/bin/MhsRequestServer

fxa      23353      1  0 Jun09 ?      00:00:00
/awips/fxa/bin/NWWSProduct

awips    24856 22545  0 18:14 ?      00:00:01 postgres: awips
fxatext 165.92.24.3(50100) idle

fxa      26179      1  0 Jun09 ?      00:00:17 /usr/bin/perl
/awips/fxa/bin/nwrTrans.pl

awips    30274 22545  0 18:18 ?      00:00:00 postgres: awips
fxatext 165.92.24.4(36102) idle

awips    30944 22545  0 18:18 ?      00:00:02 postgres: awips
fxatext 165.92.24.3(50696) idle

awips    30945 22545  0 18:18 ?      00:00:01 postgres: awips
fxatext 165.92.24.3(50698) idle

awips    30946 22545  0 18:18 ?      00:00:02 postgres: awips
fxatext 165.92.24.3(50700) idle

```

2. Look for abnormal CPU usage. Greater than 75 percent resourced by an individual process may cause problems.

**TYPE:** top

top - 18:37:10 up 114 days, 4:14, 5 users, load average: 3.38, 3.56, 3.87

Tasks: 555 total, 2 running, 553 sleeping, 0 stopped, 0 zombie

Cpu(s): 6.8%us, 1.7%sy, 0.0%ni, 81.4%id, 9.9%wa, 0.0%hi, 0.2%si, 0.0%st

Mem: 12464784k total, 12050292k used, 414492k free, 116852k buffers

Swap: 2199544k total, 3312k used, 2196232k free, 9863172k cached

PID	USER	PR	NI	VIRT	RES	SHR	S	%CPU	%MEM	TIME+	COMMAND
24115	awips	15	0	59320	41m	7372	R	39.7	0.3	0:15.96	httpd
15542	awips	16	0	75172	57m	7388	S	27.2	0.5	0:36.76	httpd
31819	awips	15	0	40740	22m	7336	S	13.6	0.2	0:04.90	httpd
30560	awips	16	0	75248	57m	7380	S	12.6	0.5	0:08.62	httpd
1188	awips postmaster	15	0	1623m	170m	149m	S	8.3	1.4	0:00.70	
30505	awips	15	0	45676	27m	7336	S	7.0	0.2	0:14.44	httpd
7581	awips postmaster	15	0	1601m	356m	352m	S	4.0	2.9	0:28.86	
22184	awips postmaster	16	0	1599m	368m	365m	D	4.0	3.0	0:54.67	
29542	awips postmaster	15	0	1599m	180m	178m	S	4.0	1.5	0:12.75	
7544	awips postmaster	15	0	1599m	175m	172m	S	3.6	1.4	0:11.40	
1182	awips postmaster	16	0	1619m	107m	92m	D	3.3	0.9	0:00.40	
4857	awips	17	0	63172	45m	7416	S	3.3	0.4	0:38.65	httpd
939	root	15	0	2712	1344	812	R	0.7	0.0	0:00.21	top
20122	awips postmaster	15	0	1596m	60m	58m	S	0.7	0.5	0:00.69	
31154	awips postmaster	15	0	1601m	777m	773m	S	0.7	6.4	0:48.09	
418	root kswapd0	10	-5	0	0	0	S	0.3	0.0	72:02.59	
4345	awips	15	0	333m	7520	2836	S	0.3	0.1	167:46.69	python

- o Check the idle time. Values less than 10 percent for the duration of the command may indicate a resource problem. Contact the NCF and report your findings.

- o A <CTRL> c will break out of the **top** command.

### 3. Check the status of message handling.

**TYPE:** `dwb_smon`

msgQueue

Server	PID	User ID	Group ID	Length	Status
msgreq_svr 20:06:21 2014	11922	root	root	0	UP @ Mon Dec 8
(nfe/11030) 20:06:21 2014	11954				UP @ Mon Dec 8
(worker) 20:06:22 2014	12018				UP @ Mon Dec 8
(worker) 20:06:23 2014	12339				UP @ Mon Dec 8
(worker) 20:27:28 2014	29724				UP @ Fri Dec 12
(worker) 20:30:07 2014	30524				UP @ Fri Dec 12
msgrcv_svr 20:06:21 2014	12013	root	root	0	UP @ Mon Dec 8
(nfe/11040) 20:06:21 2014	12015				UP @ Mon Dec 8
(worker) 20:22:08 2015	12638				UP @ Tue Jan 20
(worker) 20:23:05 2015	13036				UP @ Tue Jan 20

If there are msgqueues, notify the NCF of your findings. If nothing is returned, MHS is not running and needs to be started.

### 4. Ensure that the a2dx1 apps package is running.

**TYPE:** `hb_stat`

### 5. Ensure that the /awips2/data partition is mounted.

**TYPE:** `df /awips2/data`

Look for results similar to the following:

```
Filesystem                1K-blocks  Used    Available  Use% Mounted on
/dev/mapper/vg_aiidb-awipsiib 154818540 16722836 130231384 12%  /awips2/data
```

6. Ensure that postgres is running.

**TYPE:** `ps -wef|grep postmaster`

```
awips 30249 1 0 Jul05 ? 00:00:58 /awips2/postgresql/bin/postmaster -D /awips2/data -p 5432
```

7. Look at the most recent log in /awips2/data/pg\_log.

**TYPE:** `ls -ltr /awips2/data/pg_log`

**TYPE:** `tail -f /awips2/data/pg_log/<LOGFILE>`

8. Ensure that RCM (Radar Server) is running.

**TYPE:** `ps -wef|grep rcm`

**TYPE:** `tail -f /awips2/rcm/data/logs/radarserver.log`

9. Check for System Issues – Full partitions, load average, etc.

**TYPE:** `df -hP`

**TYPE:** `df /data_store`

10. Ensure that the directory is mounted from dx2f, as shown below, unless a2dx2apps is running on the same server as a2dx1apps.

`[root@dx1-tbw3 ~]# df /data_store`

```
Filesystem      Size  Used Avail Use% Mounted on
nas2:/dataSTORE 2147483648 1015255488 1132228160 48% /data_store
```

Ensure that the partition is mounted from the nas1:/GFESuite2 share.

**TYPE:** `df /awips2/GFESuite`

```
Filesystem          1K-blocks    Used    Available  Use% Mounted on
nas1:/GFESuite2    10485760     538432   9947328     6%  /awips2/GFESuite
```

11. Ensure that the partition is mounted from the nas1:/aiidata/utility share.

**TYPE:** `df /awips2/edex/data/utility`

```
Filesystem          1K-blocks  Used    Available  Use% Mounted on
nas1:/aiidata/utility 524288000 18008000 506280000 4%  /awips2/edex
/data/utility
```

12. Ensure that MHS is running properly.

**TYPE:** `ps -wef|grep mhs`

**TYPE:** `ypcat hosts | grep mhs`

**TYPE:** `ping dx1f`



**TYPE:** `ps -wef|grep sendmail`  
**TYPE:** `msg_stats`

### I.3 Check for Mandatory Processes on DX2F

Log in to the Linux data server running the **dx2apps** package (normally DX2).

1. Check what is mounted on the server. Verify that the NAS is mounted.

**TYPE:** `df`

- Look for **/data/fxa** and the percentage used. Percentages larger than 70 percent could indicate a problem. Notify the NCF if this is the case.
- Also look for any directories that appear to be filling up (88 percent or higher).

2. Look for abnormal CPU usage. Greater than 75 percent resourced by an individual process may cause problems.

**TYPE:** `top`

- Check the idle time. Values less than 10 percent for the duration of the command may indicate a resource problem. Contact the NCF and report your findings.
- A **<CTRL> c** will break out of the **top** command.

3. Ensure that a2dx2apps is running.

**TYPE:** `hb_stat`

4. Ensure that /data\_store is mounted locally from the NAS [NAS2].

**TYPE:** `df /data_store`

Filesystem	1K-blocks	Used	Available	Use%	Mounted on
nas2:/dataSTORE	2147483648	57418624	2090065024	3%	/data_store

5. Check for System Issues – Full partitions, load average, etc.

**TYPE:** `df -hP`

**TYPE:** `top`

6. Ensure that the partition is mounted from the nas1:/GFESuite2 share.

**TYPE:** `df /awips2/GFESuite`

7. Ensure that the partition is mounted from the nas1:/aiidata/utility share.

**TYPE:** `df /awips2/edex/data/utility`

```

Filesystem                1K-blocks Used      Available Use% Mounted on
nas1:/aiidata/utility    524288000 5316672 518971328 2%  /awips2/edex
                               /data/utility

```

8. Ensure that the /awips2/edex/data/hdf5 partition is mounted locally.

**TYPE:** `df /awips2/edex/data/hdf5`

Look for results similar to the following:

```

Filesystem      1K-blocks  Used      Available Use% Mounted on
/dev/mapper/vg_aihdf5-awipsihdf
                411817200 103372372 287525740 27% /awips2/edex/
                               data/hdf5

```

9. Ensure that Pypies is running.

**TYPE:** `ps -wef|grep pypies`

```

[root@dx2-tbdw ~]# ps -wef|grep pypies
awips      2833 25227  0 14:24 ?          00:00:09
/awips2/httpd_pypies/usr/sbin/httpd -f
/awips2/httpd_pypies/etc/httpd/conf/httpd.conf
awips      3188 25227  1 14:25 ?          00:00:09
/awips2/httpd_pypies/usr/sbin/httpd -f
/awips2/httpd_pypies/etc/httpd/conf/httpd.conf
awips      3194 25227  1 14:25 ?          00:00:10
/awips2/httpd_pypies/usr/sbin/httpd -f
/awips2/httpd_pypies/etc/httpd/conf/httpd.conf
awips      3196 25227  0 14:25 ?          00:00:08
/awips2/httpd_pypies/usr/sbin/httpd -f
/awips2/httpd_pypies/etc/httpd/conf/httpd.conf
awips      3197 25227  1 14:25 ?          00:00:09
/awips2/httpd_pypies/usr/sbin/httpd -f
/awips2/httpd_pypies/etc/httpd/conf/httpd.conf
awips      6981 25227  1 14:29 ?          00:00:06
/awips2/httpd_pypies/usr/sbin/httpd -f
/awips2/httpd_pypies/etc/httpd/conf/httpd.conf
root       11686 11539  0 14:39 pts/0    00:00:00 grep pypies
awips      22138 25227  1 14:09 ?          00:00:20
/awips2/httpd_pypies/usr/sbin/httpd -f
/awips2/httpd_pypies/etc/httpd/conf/httpd.conf
awips      22610 25227  1 14:10 ?          00:00:22
/awips2/httpd_pypies/usr/sbin/httpd -f
/awips2/httpd_pypies/etc/httpd/conf/httpd.conf
awips      22612 25227  1 14:10 ?          00:00:22
/awips2/httpd_pypies/usr/sbin/httpd -f
/awips2/httpd_pypies/etc/httpd/conf/httpd.conf
awips      22613 25227  1 14:10 ?          00:00:23
/awips2/httpd_pypies/usr/sbin/httpd -f
/awips2/httpd_pypies/etc/httpd/conf/httpd.conf
awips      22628 25227  1 14:10 ?          00:00:20

```

```

/awips2/httpd_pypies/usr/sbin/httpd -f
/awips2/httpd_pypies/etc/httpd/conf/httpd.conf
awips 22630 25227 1 14:10 ? 00:00:25
/awips2/httpd_pypies/usr/sbin/httpd -f
/awips2/httpd_pypies/etc/httpd/conf/httpd.conf
awips 22631 25227 1 14:10 ? 00:00:18
/awips2/httpd_pypies/usr/sbin/httpd -f
/awips2/httpd_pypies/etc/httpd/conf/httpd.conf
root 25218 1 0 Aug19 ? 00:00:00 su awips -c
/awips2/python/bin/python -u /awips2/python/lib/python2.7/site-
packages/pypies/logging/logProcess.py > /tmp/pypiesLoggingService.log
2>&1
awips 25222 25218 0 Aug19 ? 00:00:00 bash -c
/awips2/python/bin/python -u /awips2/python/lib/python2.7/site-
packages/pypies/logging/logProcess.py > /tmp/pypiesLoggingService.log
2>&1
awips 25226 25222 0 Aug19 ? 00:55:15
/awips2/python/bin/python -u /awips2/python/lib/python2.7/site-
packages/pypies/logging/logProcess.py
root 25227 1 0 Aug19 ? 00:00:09
/awips2/httpd_pypies/usr/sbin/httpd -f
/awips2/httpd_pypies/etc/httpd/conf/httpd.conf
root 25229 25227 0 Aug19 ? 00:00:00
/awips2/httpd_pypies/usr/sbin/rotatelogs
/awips2/httpd_pypies/var/log/httpd/error_log.%Y.%m.%d 86400
root 25230 25227 0 Aug19 ? 00:02:46
/awips2/httpd_pypies/usr/sbin/rotatelogs
/awips2/httpd_pypies/var/log/httpd/access_log.%Y.%m.%d 86400
awips 26099 25227 0 14:15 ? 00:00:12
/awips2/httpd_pypies/usr/sbin/httpd -f
/awips2/httpd_pypies/etc/httpd/conf/httpd.conf
awips 27861 25227 0 14:17 ? 00:00:11
/awips2/httpd_pypies/usr/sbin/httpd -f
/awips2/httpd_pypies/etc/httpd/conf/httpd.conf
awips 28101 25227 0 14:18 ? 00:00:12
/awips2/httpd_pypies/usr/sbin/httpd -f
/awips2/httpd_pypies/etc/httpd/conf/httpd.conf
awips 28112 25227 1 14:18 ? 00:00:14
/awips2/httpd_pypies/usr/sbin/httpd -f
/awips2/httpd_pypies/etc/httpd/conf/httpd.conf
awips 28117 25227 1 14:18 ? 00:00:13
/awips2/httpd_pypies/usr/sbin/httpd -f
/awips2/httpd_pypies/etc/httpd/conf/httpd.conf
awips 30948 25227 1 14:21 ? 00:00:11
/awips2/httpd_pypies/usr/sbin/httpd -f
/awips2/httpd_pypies/etc/httpd/conf/httpd.conf
awips 31059 25227 0 14:21 ? 00:00:10
/awips2/httpd_pypies/usr/sbin/httpd -f
/awips2/httpd_pypies/etc/httpd/conf/httpd.conf
awips 31060 25227 0 14:21 ? 00:00:10
/awips2/httpd_pypies/usr/sbin/httpd -f
/awips2/httpd_pypies/etc/httpd/conf/httpd.conf

```

```
awips    31316 25227 1 14:21 ?          00:00:12
/awips2/httpd_pypies/usr/sbin/httpd -f
/awips2/httpd_pypies/etc/httpd/conf/httpd.conf
```

#### **I.4 Check for Mandatory Processes on DX3/DX4**

Log in to the Linux data server running the **dx3apps** package (normally DX3).

1. Check what is mounted on the server. Verify that the NAS is mounted.

**TYPE:**        **df -H**

- Look for **/data/fixa** and the percentage used. Percentages larger than 70 percent could indicate a problem. Notify the NCF if this is the case.
- Also look for any directories that appear to be filling up (88 percent or higher).

2. Please make sure that the EDEX CAMEL is up and running.

**TYPE:**        **service edex\_camel status**

```
EDEX Camel (ingest) is running (wrapper PID 31622)
EDEX Camel (ingest) is running (java PID 31624)
EDEX Camel (ingestGrib) is running (wrapper PID 31732)
EDEX Camel (ingestGrib) is running (java PID 31734)
EDEX Camel (ingestDat) is running (wrapper PID 31835)
EDEX Camel (ingestDat) is running (java PID 31839)
EDEX Camel (request) is running (wrapper PID 31960)
EDEX Camel (request) is running (java PID 31962)
```

**TYPE:**        **top**

- Check the idle time. Values less than 10 percent for the duration of the command may indicate a resource problem. Contact the NCF and report your findings.
- A **<CTRL> c** will break out of the **top** command.

3. Ensure that there are four EDEX processes running, one each of the following: ingest, ingestDat, ingestGrib, and request:

```

[root@dx3-tbw3 ~]# ps -fu awips
UID          PID  PPID  C  STIME TTY          TIME CMD
awips    38316      1  0  13:52 ?           00:00:00 /bin/bash
/awips2/edex/bin/start.sh -noConsole ingest
awips    38319      1  0  13:52 ?           00:00:00 /bin/bash
/awips2/edex/bin/start.sh -noConsole ingestGrib
awips    38370      1  0  13:52 ?           00:00:00 /bin/bash
/awips2/edex/bin/start.sh -noConsole request
awips    38372      1  0  13:52 ?           00:00:00 /bin/bash
/awips2/edex/bin/start.sh -noConsole ingestDat
awips    38554  38316  0  13:52 ?           00:00:19 java -Xmx32m -
XX:MaxPermSize=12m -XX:ReservedCodeCacheSize=4m -j
awips    38555  38319  0  13:52 ?           00:00:17 java -Xmx32m -
XX:MaxPermSize=12m -XX:ReservedCodeCacheSize=4m -j
awips    38567  38370  0  13:52 ?           00:00:10 java -Xmx32m -
XX:MaxPermSize=12m -XX:ReservedCodeCacheSize=4m -j
awips    38680  38372  0  13:52 ?           00:00:23 java -Xmx32m -
XX:MaxPermSize=12m -XX:ReservedCodeCacheSize=4m -j
awips    38745  38567  15 13:52 ?           00:09:02 /awips2/java/bin/java
-Dedex.run.mode=request -Daw.site.identifi
awips    38810  38554  90 13:52 ?           00:52:24 /awips2/java/bin/java
-Dedex.run.mode=ingest -Daw.site.identifie
awips    38884  38680  29 13:52 ?           00:17:09 /awips2/java/bin/java
-Dedex.run.mode=ingestDat -Daw.site.identi
awips    38929  38555  55 13:52 ?           00:31:53 /awips2/java/bin/java
-Dedex.run.mode=ingestGrib -Daw.site.ident

```

4. Ensure that the ingest logs are all updating in /awips2/edex/logs and have low processing and latency times.

**TYPE:** `tail -f edex-ingest-$(date +%Y%m%d).log`

**TYPE:** `tail -f edex-ingestGrib-$(date +%Y%m%d).log`

**TYPE:** `tail -f edex-ingestDat-$(date +%Y%m%d).log`

**TYPE:** `tail -f edex-request-$(date +%Y%m%d).log`

**TYPE:** `tail -f edex-ingest-satellite-$(date +%Y%m%d).log`

**TYPE:** `tail -f edex-ingest-radar-$(date +%Y%m%d).log`

**TYPE:** `tail -f edex-ingest-shef-$(date +%Y%m%d).log`

**TYPE:** `tail -f edex-ingest-text-$(date +%Y%m%d).log`

**TYPE:** `tail -f edex-ingest-purge-$(date +%Y%m%d).log`

**TYPE:** `tail -f edex-ingest-shef-performance-$(date +%Y%m%d).log`

**TYPE:** `tail -f edex-ingest-gen_areal_ffg-$(date`

```

+%Y%m%d).log
TYPE: tail -f edex-request-thriftSrv-$(date
+%Y%m%d).log
TYPE: tail -f edex-ingest-archive-$(date +%Y%m%d).log
TYPE: tail -f edex-ingestGrib-activeTableChange-$(date
+%Y%m%d).log
TYPE: tail -f edex-ingestGrib-performance-$(date
+%Y%m%d).log
TYPE: tail -f edex-ingest-performance-$(date
+%Y%m%d).log
TYPE: tail -f edex-request-performance-$(date
+%Y%m%d).log
TYPE: tail -f edex-ingest-gen_areal_qpe-$(date
+%Y%m%d).log
TYPE: tail -f edex-ingest-hibernate-$(date +%Y%m%d).log
TYPE: tail -f edex-request-hibernate-$(date
+%Y%m%d).log
TYPE: tail -f edex-ingestDat-hibernate-$(date
+%Y%m%d).log
TYPE: tail -f edex-ingestGrib-hibernate-$(date
+%Y%m%d).log
TYPE: tail -f edex-request-productSrvRequest-$(date
+%Y%m%d).log
TYPE: tail -f edex-ingest-smartInit-$(date +%Y%m%d).log
TYPE: tail -f edex-ingest-unrecognized-files-$(date
+%Y%m%d).log
TYPE: tail -f edex-ingest-ohd-$(date +%Y%m%d).log
TYPE: tail -f edex-ingest-sportlma-$(date +%Y%m%d).log
TYPE: tail -f edex-request-textdbSrvRequest-$(date
+%Y%m%d).log
TYPE: tail -f edex-ingestDat-performance-$(date
+%Y%m%d).log
TYPE: tail -f edex-request-activeTableChange-$(date
+%Y%m%d).log

```

## 5. Check for System Issues – Full partitions, load average, etc.

```

TYPE:      df -H

Filesystem                Size      Used Avail Use% Mounted on
/dev/mapper/vg01-lvol01   1.2G    529M   546M   50% /
tmpfs                     4.2G         0   4.2G    0% /dev/shm
/dev/mapper/vg01-lvol_fxa 5.5G    1.3G   4.0G   24% /awips/fxa
/dev/mapper/vg01-lvol_ifps 1.4G     82M   1.2G    7% /awips/ifps
/dev/mapper/vg01-lvol_ldad 1.1G   144M   837M   15% /awips/ldad
/dev/mapper/vg01-lvol_ops 285M   136M   135M   51% /awips/ops
/dev/mapper/vg01-lvol_awips2 41G    13G    26G   33% /awips2
/dev/sda3                 98M     65M    32M   68% /boot
/dev/mapper/vg01-lvol_logs 2.2G     71M   2.0G    4% /data/logs
/dev/mapper/vg01-lvol_tmp 1.1G     19M   961M    2% /tmp
/dev/mapper/vg01-lvol_usr  11G    7.6G   2.3G   78% /usr
/dev/mapper/vg01-lvol_var 3.1G   331M   2.7G   12% /var
nas1:/awipsADAPT          1.1G   701M   373M   66% /awips/adapt
nas1:/awipsDEV            4.3G   132k   4.3G    1% /awips/dev
nas1:/awipsGFESuite      108G    18G    90G   17%
/awips/GFESuite
nas1:/awipsHYDRO         1.1T    4.0G   1.1T    1%
/awips/hydroapps
nas1:/dataLOCAL          162G    46G   116G   29% /data/local
nas1:/dataX400           630M   228M   402M   37% /data/x400
nas1:/DSshared           1.1G   413M   662M   39% /DS_shared
nas1:/dataADAPT          3.3G         0   3.3G    0% /data/adapt
nas1:/dataGFE            21M         0    21M    0% /data/GFE
nas1:/awipsHOME          119G    94G    25G   80% /home
nas1:/dataFXA            537G   388G   150G   73% /data/fxa
nas1:/aiidata            537G    11G   526G    3% /awips2/edex/data
nas1:/GFESuite2          11G   144M    11G    2%
/awips2/GFESuite
nas1:/localapps           54G    40M    54G    1% /localapps
nas2:/dataSTORE          2.2T    49G   2.2T    3% /data_store
nas1:/awips2REPO         43G    6.3G    37G   15%
/data/fxa/INSTALL/awips2
nas2:/awips2ARCHIVE      3.3T    85G   3.3T    3% /archive

```

6. Ensure that the directory is mounted from nas1:/data\_store

```
[root@dx3-tbw3 ~]# df -hP /data_store
```

```

Filesystem                Size      Used Avail Use% Mounted on
nas2:/dataSTORE          2.0T    39G   2.0T    2% /data_store

```

7. Ensure that the partition is mounted from the nas1:/GFESuite2 share.

```
TYPE:      df /awips2/GFESuite
```

8. Ensure that the partition is mounted from the nas1:/aiidata share.

```
TYPE:      df /awips2/edex/data
```

9. Ensure that the clustering loopback device is up (ifconfig lo:0).

```
TYPE:      ifconfig lo:0
```

```

lo:0      Link encap:Local Loopback
          inet addr:165.92.24.61  Mask:255.255.255.255
          UP LOOPBACK RUNNING  MTU:16436  Metric:1

```

10. Ensure that awips2ARCHIVE is mounted on nas2.

**TYPE: df -hP /archive**

Repeat steps 1 – 10 for DX4.

### I.5 Check for Abnormal Processes on CPIF

1. Ensure that a2cp1apps is running.

**TYPE: hb\_stat**

2. Ensure that QPID is running and processing.

**TYPE: ps -wef|grep qpid**

**TYPE: qpid-stat -q -S msg -L10**

Make sure that queues are not high or lingering (the numbers in the msg column drop if they are high).

Queues

queue	excl	msg	msgIn	msgOut	bytes	bytesIn	bytesOut	cons	bind	dur
=====										
_edex.alert-edex_com@amq.topic_6e404bec-1528-4423-b661-b2c2dabe9eb3		51	881k	881k	126k	6.17g	6.17g	0	2	
_edex.alert-edex_com@amq.topic_2eafd956-34fb-4d3d-8949-0ac6ce3f530e		51	2.04m	2.04m	126k	15.1g	15.1g	0	2	
Ingest.lsr		0	10.3k	10.3k	0	679k	679k	2	2	Y
_edex.alerts@amq.topic_623a5687-6f8c-4590-833c-3bfb75190a06		0	219k	219k	0	1.52g	1.52g	1	2	Y
_pluginPurged@amq.topic_36bf2e7f-29dd-4e2d-954b-1c3e986916ee		0	8.50k	8.50k	0	56.4k	56.4k	1	2	Y
Ingest.bufrssmi		0	28.0k	28.0k	0	2.13m	2.13m	2	2	Y
Ingest.nucaps		0	0	0	0	0	0	2	2	Y
Ingest.regionalsat		0	1	1	0	93	93	2	2	Y
_rebuildD2DCache@amq.topic_d216b37f-1894-453c-b200-73b3c6112f46		0	0	0	0	0	0	1	2	Y



```
mpeLightSrvScheduledWork
      0 1.73k 1.73k      0      0      0      2      2
```

3. Ensure that Pulse/IPVS is running and has edex-request JVMs connected.

**TYPE:** `ps -wef|grep pulse`

```
root      18244      1  0 Feb21 ?          00:00:00 pulse
```

**TYPE:** `ipvsadm --list`

```
IP Virtual Server version 1.2.1 (size=4096)
Prot LocalAddress:Port Scheduler Flags
-> RemoteAddress:Port Forward Weight ActiveConn InActConn
TCP  edexcluster-tbw3:9581 lc
-> dx4-tbw3:9581      Route    2      1      91
-> dx3-tbw3:9581      Route    1      3      0
```

4. Ensure that /awips2/qpid/messageStore is mounted from the nas1:qpid share.

**TYPE:** `df /awips2/qpid/messageStore`

```
[root@cpsbn1-tbw3 ~]# df /awips2/qpid/messageStore

Filesystem 1K-blocks Used Available Use% Mounted on
nas1:qpid 10485760 26688 10459072 1% /awips2/qpid/messageStore
```

5. Ensure that data is coming in, and that there are no ERROR messages.

**TYPE:** `tail -f ~ldm/logs/ldmd.log`

## I.6 Check for Abnormal Processes on CPSBNI/CPSBN2

1. Ensure that LDM is running.

**TYPE:** `ps -fu ldm`

You should see one ldmd processes, a pqact process and an edexBridge process.

```
UID          PID  PPID  C STIME TTY          TIME CMD
ldm          5094    1  0 Aug11 ?          00:00:10 notifyme -v1
slav.txt -h cpsbn1 -p F[EO][ACPU][AKNS][3-5][0-9

ldm          16867    1  0 Aug13 ?          00:00:04 ldmd -I
165.92.24.50 -P 388 -M 256 -m 3600 -o 3600 -q /usr/lo

ldm          16869 16867  1 Aug13 ?          03:06:02 pqact -e

ldm          16870 16867  0 Aug13 ?          00:22:47 edexBridge -vxl
/usr/local/ldm/logs/edexBridge.log -s cplf

ldm          25591 16867  0 13:26 ?          00:00:14 ldmd -I
165.92.24.50 -P 388 -M 256 -m 3600 -o 3600 -q /usr/lo
```

2. Ensure that six noaaportIngest processes are running.

**TYPE:**        `ps -wef | grep noaaportIngest`

```

root      14631 14625  1 Jan15 ?          02:31:19 noaaportIngest -b 10000 -
m 224.0.1.1 -n -u 3 -t mhs -r 1 -s NMC

root      14633 14625  0 Jan15 ?          00:09:04 noaaportIngest -b 10000 -
m 224.0.1.2 -n -u 4 -t mhs -r 1 -s GOES

root      14634 14625  4 Jan15 ?          06:31:36 noaaportIngest -b 10000 -
m 224.0.1.3 -n -u 5 -t mhs -r 1 -s NMC2

root      14635 14625  0 Jan15 ?          00:10:40 noaaportIngest -b 10000 -
m 224.0.1.4 -n -u 6 -t mhs -r 1 -s NOAAPORT_OPT

root      14636 14625  0 Jan15 ?          00:00:02 noaaportIngest -b 10000 -
m 224.0.1.5 -n -u 7 -t mhs -r 1 -s NMC3

root      14637 14625  0 Jan15 ?          00:10:13 noaaportIngest -b 10000 -
m 224.0.1.6 -n -u 4 -t mhs -r 1 -s ADD

```

**Note:** ADD channel will only exist at sites where Data Delivery is activated. As of now, that is limited to test beds and a few regions. Once Data Delivery is “activated and operational”, then all the sites would see the 6<sup>th</sup> channel (ADD).

3. Check for System Issues – Full partitions, load average, etc.

**TYPE:**        `top`

### ***I.7 Check for Abnormal Processes on AX***

Log in to the AX server.

1. Check what is mounted on the AX. Look for any directories that appear to be filling up (88 percent or higher). Verify that the **/home**, **/data/fxa**, and **/data/local** directories are mounted from the NAS.

**TYPE:**        `df -H`

2. Look for abnormal CPU usage. Any individual process using greater than 75 percent of the CPU may cause system problems.

**TYPE:**        `top`

- Check the idle time. Values less than 10 percent for the duration of the command may indicate a resource problem. Contact the NCF and report your findings.
- A **<CTRL> c** will break out of the **top** command.

### ***I.8 Check for Mandatory Processes on PX1***

Log in to the server running the **px1apps** package (normally PX1).

1. Check what is mounted on PX1. Verify that the NAS is mounted. Look for any

directories that appear to be filling up (88 percent or higher).

**TYPE:** `df -H`

2. **TYPE:** `ps -wef |grep fxa`

Verify that the **fxa** processes are running:

3. Look for abnormal CPU usage. Any individual process using greater than 75 percent of the CPU may cause system problems.

**TYPE:** `top`

- Check the idle time. Values less than 10 percent for the duration of the command may indicate a resource problem. Contact the NCF and report your findings.
- A <CTRL> c will break out of the **top** command.

4. Ensure that a2px1apps is running.

**TYPE:** `hb_stat`

5. Ensure that re-hosted applications are running.

**TYPE:** `ps -fu fxa`

The following can be seen running on the server: The asyncScheduler and NWSWS might vary in use from site to site.

asyncPilMsgServer

asyncScheduler

asyncPollData.pl

hmMonitorServer

NWSWSchedule

**Note:** The awips2\_radarIngest.pl, laps\_driver.pl, and remap\_polar\_netcdf.exe are not constant processes. They may or may not show. The user must verify that the log files are updating and that LAPS data is current in the system.

6. Check for System Issues – Full partitions, load average, etc.

**TYPE:** `df -H`

**TYPE:** `top`

**TYPE:** `df /data_store`

7. Ensure that the directory is mounted from nas2:/dataSTORE

[root@dx1-hgx ~]# `df -hP /data_store`

Filesystem	Size	Used	Available	Use%	Mounted on
------------	------	------	-----------	------	------------

```
nas2:/dataSTORE  2.0T    56G    2.0T    3%    /data_store
```

9. Ensure that the directory is mounted from the nas1:aiidata/utility as shown below:

**TYPE:** `df /awips2/edex/data/manual`

```
Filesystem      1K-blocks    Used      Available  Use%  Mounted on
nas1:/aiidata  524288000    16934272  507353728  4%    /awips2/edex/data
```

## I.9 Check for Mandatory Processes on PX2

Log in to the server running the **px2apps** package (normally PX2).

1. Check what is mounted on PX2. Verify that the NAS is mounted. Look for any directories that appear to be filling up (88 percent or higher).

**TYPE:** `df -H`

2. **TYPE:** `ps -wef |grep fxa`

Verify that the **fxa** processes listed below are running.

```
/dev/mapper/vg01-lvol01    1.1G  662M  302M  69% /
tmpfs                     6.3G    0  6.3G   0% /dev/shm
/dev/mapper/vg01-lvol_fxa  5.1G  2.9G  2.0G  60% /awips/fxa
/dev/mapper/vg01-lvol_ifps 1.6G  2.4M  1.5G   1% /awips/ifps
/dev/mapper/vg01-lvol_laps 1.1G  146M  818M  16% /awips/laps
/dev/mapper/vg01-lvol_ldad 1.1G  236M  728M  25% /awips/ldad
/dev/mapper/vg01-lvol_ops  297M   83M  198M  30% /awips/ops
/dev/mapper/vg01-lvol_awips2 11G  4.0G  6.0G  40% /awips2
/dev/sda3                  98M   66M   27M  72% /boot
/dev/mapper/vg01-lvol_logs 2.1G  396M  1.6G  21% /data/logs
/dev/mapper/vg01-lvol_tmp  500M   13M  461M   3% /tmp
/dev/mapper/vg01-lvol_usr   16G   12G  3.3G  78% /usr
/dev/mapper/vg01-lvol_var   3.1G  594M  2.3G  21% /var
nas1:/awipsADAPT          1.1G  745M  330M  70% /awips/adapt
nas1:/awipsDEV            4.3G  173k  4.3G   1% /awips/dev
nas1:/awipsGFESuite/ws    108G   19G   89G  18% /awips/GFESuite
```

nas1:/awipsHOME	119G	77G	42G	65%	/home
nas1:/awipsHYDRO /awips/hydroapps	108G	818M	107G	1%	
nas1:/dataADAPT	3.3G	0	3.3G	0%	/data/adapt
nas1:/dataFXA	537G	297G	241G	56%	/data/fxa
nas1:/dataGFE	21M	0	21M	0%	/data/GFE
nas1:/dataLOCAL	162G	54G	108G	34%	/data/local
nas1:/localapps	54G	123M	54G	1%	/localapps
nas1:/awips2REPO /data/fxa/INSTALL/awips2	43G	21G	23G	49%	
nas2:/awips2ARCHIVE	3.3T	1.3T	2.1T	37%	/archive
nas1:/bmhDATA /awips2/bmh/data	43G	18M	43G	1%	
nas1:/bmhCONF /awips2/bmh/conf	22G	0	22G	0%	
nas1:/bmhRESULTS /awips2/bmh/neospeech/result	22G	0	22G	0%	
nas2:/dataSTORE	2.2T	1.1T	1.2T	47%	/data_store
nas1:/aiidata /awips2/edex/data	537G	55G	483G	11%	
nas1:/verify	2.2T	6.5G	2.2T	1%	/data/verify
nas1:/GFESuite2 /awips2/GFESuite	11G	2.5G	8.4G	23%	

3. Look for abnormal CPU usage. Any individual process using greater than 75 percent of the CPU may cause system problems.

**TYPE:** `top`

- Check the idle time. Values less than 10 percent for the duration of the command may indicate a resource problem. Contact the NCF and report your findings.
- A <CTRL> c will break out of the top command.

4. Ensure that a2px2apps is running.

**TYPE:** `hb_stat`

5. Ensure that rehosted applications are running.

**TYPE:** `ps -fu ldad`

The following should be running on the server:

```

UID    PID PPID C STIME TTY      TIME CMD
ldad   6604 22128 0 15:06 ?       00:00:00 sleep 30
ldad   7298  1 0 Aug13 ?       00:00:00 /awips/fxa/bin/CommsRouter LDAD_ROUTER
ldad   7308  1 0 Aug13 ?       00:00:10 /awips/fxa/bin/DataController LDAD_ROUTER
LdadController.config
ldad   7311 7308 0 Aug13 ?       00:00:00 /awips/fxa/bin/routerLdadDecoder px2-
tbw3/48453/7308 157164912
ldad   7312 7308 0 Aug13 ?       00:00:02 /awips/fxa/bin/routerStoreNetcdf px2-
tbw3/48453/7308 157191456
ldad   7313 7308 0 Aug13 ?       00:00:00 /awips/fxa/bin/routerStoreEDEX px2-
tbw3/48453/7308 157200504
ldad   7314 7308 0 Aug13 ?       00:00:02 /awips/fxa/bin/routerShefEncoderEDEX px2-
tbw3/48453/7308 157200712
ldad   7315 7308 0 Aug13 ?       00:00:07 /awips/fxa/bin/routerStoreTextEDEX px2-
tbw3/48453/7308 157201016
ldad   9835 22128 0 00:00 ?       00:00:02 /usr/bin/perl /awips/ldad/bin/pollForData.pl
Start /awips/ldad/data/
ldad   22090  1 0 Aug20 ?       00:00:00 /awips/ldad/bin/listener
ldad   22128  1 0 Aug20 ?       00:00:17 /bin/sh /awips/ldad/bin/watchDogInternal.sh

```

6. **Enter:** `ps -fu fxa`

Look for the following processes running:

```

ldadServer
fsiWatchdog.sh
FSIprocessorEDEX
rssi

```

7. Check for System Issues – Full partitions, load average, etc.

```

TYPE:    df    -hP
TYPE:    top
TYPE:    df    /data_store

```

8. Ensure that the directory is mounted from nas2:/dataSTORE

```

TYPE:    df -hP /data_store

Filesystem      Size      Used    Available    Use%    Mounted on
nas2:/dataSTORE 2.0T      56G     2.0T         3%      /data_store

```

9. Ensure that the directory is mounted from the nas1:aiidata/utility as shown below:

**TYPE:** `df /awips2/edex/data/manual`

Filesystem	1K-blocks	Used	Available	Use%	Mounted on
nas1:aiidata	524288000	16936448	507351552	4%	/awips2/edex/data

10. Ensure that the directory is mounted from the nas1:aiidata/share as shown below.

**TYPE:** `df /awips2/edex/data/share`

Filesystem	1K-blocks	Used	Available	Use%	Mounted on
nas1:aiidata	524288000	16936448	507351552	4%	/awips2/edex/data

### ***I.10 Check for Mandatory Processes on REP Servers (RFCs only)***

Log in to rp1-<siteID> as user root.

1. Check what is mounted on RP1. Look for any directories that appear to be filling up (88 percent or higher). Verify that the REP NAS is mounted.

**TYPE:** `df -H`

2. Look for abnormal CPU usage. Any individual process using greater than 75 percent of the CPU may cause system problems.

**TYPE:** `top`

- Check the idle time. Values less than 10 percent for the duration of the command may indicate a resource problem. Contact the NCF and report your findings.
- A <CTRL> c will break out of the top command.

3. Repeat steps 1 and 2 on RP2.

### ***I.11 Checklist for Servers and Workstations***

#### ***I.11.1 Servers***

##### **DX1**

1. Check to see whether postgres is running.

**TYPE:** `ps -ef | grep postgres`

```
awips      1364 15282  0 18:52 ?        00:00:00 postgres: awips
metadata 165.92.24.3(53649) idle

awips      1556 15282  0 18:52 ?        00:00:00 postgres: awips
fxatext 165.92.24.4(50940) idle

awips      1617 15282  3 18:52 ?        00:00:55 postgres: awips maps
165.92.24.3(53667) idle
```

```

awips      2958 15282  0 18:54 ?      00:00:12 postgres: awips
fxatext 165.92.24.3(53748) idle

awips      4407 15282  0 18:14 ?      00:00:05 postgres: awips
metadata 165.92.24.3(44624) idle

awips      4409 15282  0 18:14 ?      00:00:04 postgres: awips
metadata 165.92.24.3(44626) idle

awips      4410 15282  0 18:14 ?      00:00:05 postgres: awips
metadata 165.92.24.3(44627) idle

awips      7601 15282  0 18:59 ?      00:00:00 postgres: awips
metadata 165.92.24.3(39837) idle

awips      15404 15282  0 Jan21 ?      00:00:01 postgres: logger
process

awips      15455 15282  0 Jan21 ?      00:00:01 postgres: writer
process

awips      15456 15282  0 Jan21 ?      00:00:00 postgres: wal writer
process

awips      15457 15282  0 Jan21 ?      00:00:00 postgres: autovacuum
launcher process

awips      15458 15282  0 Jan21 ?      00:00:42 postgres: stats
collector process

awips      15952 15282  0 19:09 ?      00:00:00 postgres: awips
hd_ob92oax 165.92.24.3(57044) idle

awips      15953 15282  0 19:09 ?      00:00:00 postgres: awips
hd_ob92oax 165.92.24.3(57045) idle

awips      16061 15282  0 18:29 ?      00:00:01 postgres: awips
metadata 165.92.24.3(43691) idle

```

**Note:** Check the logs at /awips2/data/pg\_log.

**Note:** Check the logs at /awips2/rcm/data/logs.

## 2. Check to see whether any partitions are full.

```

TYPE:      df -H

/dev/mapper/vg01-lvol01      1.1G  659M  321M  68% /
tmpfs                        6.3G    0  6.3G   0% /dev/shm
/dev/mapper/vg01-lvol_fxa    5.2G  1.9G  3.1G  38% /awips/fxa
/dev/mapper/vg01-lvol_ifps  1.4G   82M  1.2G   7% /awips/ifps
/dev/mapper/vg01-lvol_ldad  1.1G   84M  897M   9% /awips/ldad
/dev/mapper/vg01-lvol_ops    305M  183M  107M  64% /awips/ops
/dev/mapper/vg01-lvol_awips2  34G   2.3G   30G   8% /awips2
/dev/mapper/mpathdp3         98M   58M   35M  63% /boot
/dev/mapper/vg01-lvol_logs   11G   205M  9.9G   3% /data/logs
/dev/mapper/vg01-lvol_tmp    1.1G   21M  959M   3% /tmp
/dev/mapper/vg01-lvol_usr    11G   8.3G  1.6G  85% /usr
/dev/mapper/vg01-lvol_var    3.1G  947M  2.0G  33% /var

```



```

nas1:/awipsADAPT          1.1G  707M  367M  66% /awips/adapt
nas1:/awipsDEV            4.3G  132k  4.3G   1% /awips/dev
nas1:/awipsGFESuite      108G  18G   90G  17%
                        /awips/GFESuite
nas1:/awipsHYDRO         1.1T  4.0G  1.1T   1% /awips/hydroapps
nas1:/dataLOCAL          162G   49G  113G  30% /data/local
nas1:/dataX400           630M  228M  402M  37% /data/x400
nas1:/DSshared           1.1G  410M  664M  39% /DS_shared
nas1:/dataADAPT          3.3G    0  3.3G   0% /data/adapt
nas1:/dataGFE             21M    0   21M   0% /data/GFE
nas1:/awipsHOME          119G   97G   22G  82% /home
nas1:/dataFXA            537G  391G  147G  73% /data/fxa
nas1:/aiidata/utility    537G   14G  524G   3%
                        /awips2/edex/data/utility
nas1:/localapps           54G   39M   54G   1% /localapps
nas2:/dataSTORE          2.2T   41G  2.2T   2% /data_store
nas2:/awips2ARCHIVE      3.3T   57G  3.3T   2% /archive
nas1:/storage            537G  186G  352G  35% /awips/storage
nas1:/awips2REPO         43G   6.3G   37G  15%
                        /data/fxa/INSTALL/awips2
nas1:/awipscm            269G   20G  249G   8% /awipscm
/dev/mapper/vg_aiidb-awipsiadb 159G   18G  133G  12% /awips2/data
nas1:/GFESuite2          11G  204M   11G   2%
                        /awips2/GFESuite

```

**Note:** Check to see if everything is mounted (/awips2, /awips2/db, /awips2/GFESuite).

3. Check to see whether the Heartbeat, a2dx1apps, and dx1f up (ping dx1f) are running.
4. Check to see whether MHS is running.

```

TYPE:      ps -ef | grep mhs
root          627 31786  0 16:07 pts/0    00:00:00 grep mhs
root          13644  1  0 Nov11 ?          00:00:00 archive_msgreq -
p/data/mhs/archive/req_pipe -o/data/mhs/archive/req/processed
root          13647  1  0 Nov11 ?          00:00:00 archive_msgresp -
p/data/mhs/archive/resp_pipe -o/data/mhs/archive/resp/processed
root          32211  1  0 Nov21 ?          00:00:01 mdp_daemon -k 7789 -f
/awips/ops/data/mhs/mdp-smtp.cfg
awipsmhs     32213 32211  0  Nov21 ?          00:01:08 smtp_send -eb -cz -
k7789 -n0 -p/tmp/smtp0_send_fifo
awipsmhs     32365  1  0 Nov21 ?          00:00:18 smtp_rcv -n0 -m0 -
o/data/mhs/smtp_rcv/output -b/var/spool/mail/awipsmhs

```

**TYPE: ypcat hosts | grep mhs**

```

165.92.33.65 dx1f-box cpCfgHost mhs siteTime mhs dx1f
165.92.33.65 dx1f-box cpCfgHost mhs siteTime mhs dx1f
165.92.33.65 dx1f-box cpCfgHost mhs siteTime mhs dx1f
165.92.33.65 dx1f-box cpCfgHost mhs siteTime mhs dx1f
165.92.33.65 dx1f-box cpCfgHost mhs siteTime mhs dx1f

```

## 5. Check to see whether sendmail is running.

**TYPE: ps -ef | grep sendmail**

```

fxa          7935  6688  0 13:50 ?          00:00:00 /usr/sbin/sendmail -
FCronDaemon -i -odi -oem -oi -t
sridharb 22665 14878  0 14:00 pts/15    00:00:00 grep sendmail
root       27298      1  0 Mar28 ?          00:06:37 sendmail: accepting
connections
smmmsp    27306      1  0 Mar28 ?          00:00:03 sendmail: Queue
runner@00:00:10 for /var/spool/clientmqueue

```

**TYPE: msg\_send -atbdr -c0**

TBW3-75458

## 6. To monitor the MHS queues at the site:

**TYPE dwb\_smon**

Server	PID	User	ID	Group	ID	Length	Status
msgreq_svr	24495	root		root		0	UP @ Fri Feb 11
13:05:29 2011							
(nfe/11030)	24496						UP @ Fri Feb 11
13:05:29 2011							
(worker)	24498						UP @ Fri Feb 11
13:05:29 2011							
(worker)	24741						UP @ Fri Feb 11
13:05:30 2011							
(worker)	24872						UP @ Fri Feb 11
13:05:31 2011							
(worker)	25164						UP @ Fri Feb 11
13:05:32 2011							
msgrcv_svr	24511	root		root		0	UP @ Fri Feb 11
13:05:29 2011							
(nfe/11040)	24514						UP @ Fri Feb 11
13:05:29 2011							
(worker)	23741						UP @ Fri Feb 11
17:18:59 2011							
(worker)	29667						UP @ Fri Feb 11
17:28:03 2011							

**DX2**

Check to see whether any partitions are full.

```

TYPE:      df -H

Filesystem                Size  Used Avail Use% Mounted on
/dev/mapper/vg01-lvol01   1.1G  420M  561M  43% /
tmpfs                     6.3G   0  6.3G   0% /dev/shm
/dev/mapper/vg01-lvol_fxa  5.2G  1.5G  3.5G  30% /awips/fxa
/dev/mapper/vg01-lvol_ifps 1.4G   82M  1.2G   7% /awips/ifps
/dev/mapper/vg01-lvol_ldad 1.1G   85M  896M   9% /awips/ldad
/dev/mapper/vg01-lvol_ops  305M  122M  168M  42% /awips/ops
/dev/mapper/vg01-lvol_awips2 34G   2.3G   30G   8% /awips2
/dev/mapper/mpathap3      102M   67M   30M  70% /boot
/dev/mapper/vg01-lvol_logs  11G  166M  9.9G   2% /data/logs
/dev/mapper/vg01-lvol_tmp  1.1G   19M  962M   2% /tmp
/dev/mapper/vg01-lvol_usr   11G   8.5G  1.4G  87% /usr
/dev/mapper/vg01-lvol_var   3.1G  356M  2.6G  13% /var
nas1:/awipsADAPT           1.1G  701M  373M  66% /awips/adapt
nas1:/awipsDEV             4.3G  132k  4.3G   1% /awips/dev
nas1:/awipsGFESuite        108G   18G   90G  17% /awips
                               /GFESuite
nas1:/awipsHYDRO           1.1T  4.0G  1.1T   1%
                               /awips/hydroapps
nas1:/dataLOCAL            162G   46G  116G  29% /data/local
nas1:/dataX400             630M  228M  402M  37% /data/x400
nas1:/DSshared             1.1G  413M  662M  39% /DS_shared
nas1:/dataADAPT           3.3G   0  3.3G   0% /data/adapt
nas1:/dataGFE              21M   0  21M   0% /data/GFE
nas1:/awipsHOME            119G   94G  25G  80% /home
nas1:/dataFXA              537G  388G  150G  73% /data/fxa
nas1:/aiidata/utility      537G   11G  526G   3% /awips2/edex
                               /data/utility
nas1:/GFESuite2            11G  144M   11G   2% /awips2
                               /GFESuite
nas1:/localapps            54G   40M   54G   1% /localapps
nas2:/dataSTORE            2.2T   49G  2.2T   3% /data_store
nas1:/awips2REPO           43G   6.3G   37G  15%
                               /data/fxa/INSTALL/awips2
nas2:/awips2ARCHIVE        3.3T   8.2G  3.3T   1% /archive
/dev/mapper/vg_aiihdf5-awipsiihdf5 422G   78G  324G  20% /awips2/edex
                               /data/hdf5

```

**Note:** Check to see if everything is mounted (/awips2, /awips2/db, /awips2/GFESuite).

**DX3/4**

1. Check to see whether edex ingest, ingestGrib, and request are running.

```
TYPE:      ps -ef | grep edex
```

**Note:** Make sure they are logging and ingesting data in /awips2/edex/logs.

2. Check to see whether any partitions are full.

```

TYPE:      df -H

Filesystem                Size  Used Avail Use% Mounted on

```

```

/dev/mapper/vg01-lvol01      1.2G  529M  546M  50% /
tmpfs                       4.2G    0  4.2G   0% /dev/shm
/dev/mapper/vg01-lvol_fxa   5.5G  1.3G  4.0G  24% /awips/fxa
/dev/mapper/vg01-lvol_ifps  1.4G   82M  1.2G   7% /awips/ifps
/dev/mapper/vg01-lvol_ldad  1.1G  144M  837M  15% /awips/ldad
/dev/mapper/vg01-lvol_ops   285M  136M  135M  51% /awips/ops
/dev/mapper/vg01-lvol_awips2 41G   13G   26G  33% /awips2
/dev/sda3                   102M   65M   32M  68% /boot
/dev/mapper/vg01-lvol_logs  2.2G   71M  2.0G   4% /data/logs
/dev/mapper/vg01-lvol_tmp   1.1G   19M  961M   2% /tmp
/dev/mapper/vg01-lvol_usr    11G   7.6G  2.3G  78% /usr
/dev/mapper/vg01-lvol_var    3.1G  331M  2.7G  12% /var
nas1:/awipsADAPT            1.1G  701M  373M  66% /awips/adapt
nas1:/awipsDEV              4.3G  132k  4.3G   1% /awips/dev
nas1:/awipsGFESuite         108G   18G   90G  17% /awips/GFESuite
nas1:/awipsHYDRO            1.1T  4.0G  1.1T   1% /awips/hydroapps
nas1:/dataLOCAL             162G   46G  116G  29% /data/local
nas1:/dataX400              630M  228M  402M  37% /data/x400
nas1:/DSshared              1.1G  413M  662M  39% /DS_shared
nas1:/dataADAPT            3.3G    0  3.3G   0% /data/adapt
nas1:/dataGFE               21M    0   21M   0% /data/GFE
nas1:/awipsHOME            119G   94G   25G  80% /home
nas1:/dataFXA               537G  388G  150G  73% /data/fxa
nas1:/aiidata               537G   11G  526G   3% /awips2/edex/data
nas1:/GFESuite2             11G  144M   11G   2% /awips2/GFESuite
nas1:/localapps             54G   40M   54G   1% /localapps
nas2:/dataSTORE             2.2T   50G  2.2T   3% /data_store
nas1:/awips2REPO            43G   6.3G   37G  15%
                               /data/fxa/INSTALL/awips2

nas2:/awips2ARCHIVE         3.3T  8.2G  3.3T   1% /archive

```

**Note:** Check to see if everything is mounted (/awips2, /awips2/db, /awips2/GFESuite)

3. Check to see whether the clustering loopback device is up.

**TYPE:** `ifconfig lo:0`

```

lo:0      Link encap:Local Loopback
          inet addr:165.92.24.61  Mask:255.255.255.255
          UP LOOPBACK RUNNING  MTU:16436  Metric:1

```

## CPSBN

1. Check to see whether ldm is running on cpsbn1 and cpsbn2.

**TYPE:** `ps -wef | grep ldm`

```

ldm      14708 13780  0 01:36 pts/0    00:00:00 grep ldm
ldm      31149    1  0 Jul19 ?          00:00:00 ldmd -I 0.0.0.0 -P
388 -M 256 -m 3600 -o 3600 -q /usr/local/ldm/data/ldm.pg
/usr/local/ldm/etc/ldmd.conf
ldm      31150 31149  0 Jul19 ?          00:47:15 pqact -e
ldm      31152 31149  0 Jul19 ?          00:10:09 edexBridge -vxl
/usr/local/ldm/logs/edexBridge.log -s cplf

```

## 2. Check to see whether qpid is running on cpsbn1

**TYPE:** `ps -ef | grep qpid`

```

root      10750 10636  0 19:52 pts/0      00:00:00 grep qpid
root      32392     1  0 2013 ?          00:00:00 su awips -c /bin/bash
           /awips2/qpid/bin/qpid-wrapper
awips     32394 32392  0 2013 ?          00:00:00 /bin/bash
           /awips2/qpid/bin/qpid-wrapper
awips     32397 32394  0 2013 ?          00:01:40 /awips2/java/bin/java
           -Xmx32m -XX:MaxPermSize=12m -XX:ReservedCodeCacheSize=4m -jar
           /awips2/qpid/bin/yajsw/wrapper.jar -c /awips2/qpid/conf/wrapper.conf
awips     32424 32397  9 2013 ?          3-15:53:27
           /awips2/java/bin/java -classpath
           /awips2/qpid/bin/yajsw/./wrapperApp.jar:/awips2/qpid/bin/yajsw/wrappe
           r.jar:/awips2/qpid/lib/opt/*:/awips2/qpid/lib/opt/qpid-deps/* -
           XX:+UseConcMarkSweepGC -XX:+CMSIncrementalMode -XX:NewSize=400m -
           XX:MaxNewSize=400m -XX:SurvivorRatio=4 -
           XX:+HeapDumpOnOutOfMemoryError -XX:HeapDumpPath=/data/fxa/qpid -
           server -DPNAME=QPBRKR -Damqj.logging.level=info -
           DQPID_HOME=/awips2/qpid -DQPID_WORK=/awips2/qpid -
           Damqj.read_write_pool_size=32 -
           Dqpid.broker.exceptionHandler.continue=true -Xmx2048m -
           Dwrapper.port=15003 -Dwrapper.key=-7261080382435685649 -
           Dwrapper.tmp.path=/tmp -Djna_tmpdir=/tmp -
           Dwrapper.config=/awips2/qpid/conf/wrapper.conf
           org.rzo.yajsw.app.WrapperJVMMain

```

## 3. Check to see whether IPVS running.

**TYPE:** `ps -ef | grep pulse`

```

root      29652     1  0 Apr06 ?          00:00:00 pulse

```

**TYPE:** `ps -ef | grep ipvsadm`

```

root      18398 18389  0 Feb21 ?          00:09:28 /usr/sbin/nanny -c -h
           165.92.24.3 -p 9581 -s GET / HTTP/1.0\r\n\r\n -x HTTP -a 15 -I
           /sbin/ipvsadm -t 6 -w 1 -V 165.92.24.61 -M g -U none --lvs
root      18399 18389  0 Feb21 ?          00:09:59 /usr/sbin/nanny -c -h
           165.92.24.4 -p 9581 -s GET / HTTP/1.0\r\n\r\n -x HTTP -a 15 -I
           /sbin/ipvsadm -t 6 -w 2 -V 165.92.24.61 -M g -U none --lvs

```

## 4. Check to see whether the partitions are full.

**TYPE:** `df -H`

**PX1**

## 1. Check to see whether the partitions are full.

**TYPE:** `df -H`

Filesystem	Size	Used	Avail	Use%	Mounted on
/dev/mapper/vg01-lvol01	1.1G	444M	537M	46%	/
tmpfs	6.3G	0	6.3G	0%	/dev/shm
/dev/mapper/vg01-lvol_fxa	5.1G	1.6G	3.4G	33%	/awips/fxa
/dev/mapper/vg01-lvol_ifps	1.6G	36M	1.5G	3%	/awips/ifps
/dev/mapper/vg01-lvol_laps	1.1G	144M	837M	15%	/awips/laps
/dev/mapper/vg01-lvol_ldad	1.1G	179M	802M	19%	/awips/ldad
/dev/mapper/vg01-lvol_ops	305M	85M	205M	30%	/awips/ops
/dev/mapper/vg01-lvol_awips2	11G	1.9G	8.2G	19%	/awips2
/dev/sda3	102M	65M	32M	67%	/boot
/dev/mapper/vg01-lvol_logs	2.1G	548M	1.5G	28%	/data/logs
/dev/mapper/vg01-lvol_tmp	508M	11M	471M	3%	/tmp
/dev/mapper/vg01-lvol_usr	27G	13G	13G	49%	/usr
/dev/mapper/vg01-lvol_var	3.1G	358M	2.6G	13%	/var
nas1:/awipsADAPT	1.1G	732M	343M	69%	/awips/adapt
nas1:/awipsDEV	4.3G	173k	4.3G	1%	/awips/dev
nas1:/awipsGFESuit/ws	108G	19G	89G	18%	/awips/GFESuite
nas1:/awipsHOME	119G	81G	38G	69%	/home
nas1:/awipsHYDRO	108G	886M	107G	1%	/awips/hydroapps
nas1:/dataADAPT	3.3G	0	3.3G	0%	/data/adapt
nas1:/dataFXA	537G	373G	164G	70%	/data/fxa
nas1:/dataGFE	21M	0	21M	0%	/data/GFE
nas1:/dataLOCAL	162G	56G	106G	35%	/data/local
nas1:/localapps	54G	156M	54G	1%	/localapps
nas2:/dataSTORE	2.2T	1.1T	1.2T	48%	/data_store
nas1:/awips2REPO	43G	23G	21G	53%	
/data/fxa/INSTALL/awips2					
nas1:/bmhDATA	43G	15M	43G	1%	/awips2/bmh/data
nas1:/bmhCONF	22G	66k	22G	1%	/awips2/bmh/conf
nas1:/bmhRESULTS	22G	7.7M	22G	1%	
/awips2/bmh/neospeech/result					
nas2:/awips2ARCHIVE	3.3T	9.8G	3.3T	1%	/archive
nas1:/dataARCHIVER	1.1T	8.9G	1.1T	1%	/data/archiver
nas1:/aiidata	537G	65G	473G	12%	/awips2/edex/data
nas1:/verify	2.2T	5.7G	2.2T	1%	/data/verify
nas1:/GFESuite2	11G	2.5G	8.3G	24%	/awips2/GFESuite

2. Check to see whether everything is mounted on /awips2, /data\_store.
3. Check to see whether the heartbeat is running, if a2px1apps is running, and if px1f is up (ping px1f).
4. Check to see whether the Rehosted applications are running.

**TYPE:**        **ps -ef | grep fxa**

```

fxa      17841      1  0 Oct10 ?          00:17:56
/awips/fxa/bin/purgeProcess -commit
fxa      23433    8715  0 17:42 ?          00:00:00 crond
fxa      23434    23433  0 17:42 ?          00:00:00 /bin/sh -c /bin/csh -
c '/usr/bin/perl /awips/laps/etc/awips2_satIngest.pl /awips/laps
/data/fxa/laps' > /dev/null 2>&1; /bin/csh -c '/usr/bin/perl
/awips/laps/etc/laps_driver.pl lvd_sat_ingest.exe /awips/laps
/data/fxa/laps' > /dev/null 2>&1
fxa      23435    23434  1 17:42 ?          00:00:00 /bin/csh -c
/usr/bin/perl /awips/laps/etc/awips2_satIngest.pl /awips/laps

```

```

/data/fxa/laps
fxa      23602 23435  0 17:42 ?          00:00:00 /usr/bin/perl
/awips/laps/etc/awips2_satIngest.pl /awips/laps /data/fxa/laps
fxa      23604 23602  1 17:42 ?          00:00:00 /bin/csh
/awips/fxa/bin/convertSat.csh 20111029_1730
fxa      24605 23604  0 17:42 ?          00:00:00 sleep 3
root     24610 24116  0 17:42 pts/0      00:00:00 grep fxa
fxa      31697     1  0 Oct13 ?          00:00:00
/awips/fxa/bin/asyncPilMsgServer
fxa      31700     1  0 Oct13 ?          00:12:11
/awips/fxa/bin/asyncScheduler
fxa      31930 31700  0 Oct13 ?          00:00:08 test1 23 20 1 test1
/dev/ttyln1a 9600 8 NONE 1 NONE
fxa      31954     1  0 Oct13 ?          00:00:02 /usr/bin/perl
/awips/fxa/bin/asyncPollData.pl
fxa      31962     1  0 Oct13 ?          00:00:00
/awips/fxa/bin/hmMonitorServer
fxa      32101     1  0 Oct13 ?          00:00:01
/awips/fxa/bin/NWSSchedule
/awips/fxa/bin/ingProcMon.pl -c PX1

```

## PX2

1. Check to see whether any partitions are full.

**TYPE:**        **df -H**

Filesystem	Size	Used	Avail	Use%	Mounted on
/dev/mapper/vg01-lvol01	1.1G	444M	537M	46%	/
tmpfs	6.3G	0	6.3G	0%	/dev/shm
/dev/mapper/vg01-lvol_fxa	5.2G	2.0G	3.0G	41%	/awips/fxa
/dev/mapper/vg01-lvol_ifps	1.6G	36M	1.5G	3%	/awips/ifps
/dev/mapper/vg01-lvol_laps	1.1G	145M	836M	15%	/awips/laps
/dev/mapper/vg01-lvol_ldad	1.1G	251M	730M	26%	/awips/ldad
/dev/mapper/vg01-lvol_ops	305M	87M	203M	30%	/awips/ops
/dev/mapper/vg01-lvol_awips2	11G	1.9G	8.2G	19%	/awips2
/dev/sda3	102M	65M	33M	67%	/boot
/dev/mapper/vg01-lvol_logs	2.1G	38M	2.0G	2%	/data/logs
/dev/mapper/vg01-lvol_tmp	508M	12M	471M	3%	/tmp
/dev/mapper/vg01-lvol_usr	27G	13G	13G	49%	/usr
/dev/mapper/vg01-lvol_var	3.1G	359M	2.6G	13%	/var
nas1:/awipsADAPT	1.1G	732M	343M	69%	/awips/adapt
nas1:/awipsDEV	4.3G	173k	4.3G	1%	/awips/dev
nas1:/awipsGFESuit/ws	108G	19G	89G	18%	/awips/GFESuite
nas1:/awipsHOME	119G	81G	38G	69%	/home
nas1:/awipsHYDRO	108G	886M	107G	1%	/awips/hydroapps
nas1:/dataADAPT	3.3G	0	3.3G	0%	/data/adapt
nas1:/dataFXA	537G	373G	164G	70%	/data/fxa
nas1:/dataGFE	21M	0	21M	0%	/data/GFE
nas1:/dataLOCAL	162G	56G	106G	35%	/data/local
nas1:/localapps	54G	156M	54G	1%	/localapps
nas2:/dataSTORE	2.2T	1.1T	1.2T	48%	/data_store
nas1:/awips2REPO	43G	23G	21G	53%	
/data/fxa/INSTALL/awips2					

nas1:/bmhDATA	43G	15M	43G	1%	/awips2/bmh/data
nas1:/bmhCONF	22G	66k	22G	1%	/awips2/bmh/conf
nas1:/bmhRESULTS	22G	7.7M	22G	1%	
/awips2/bmh/neospeech/result					
nas2:/awips2ARCHIVE	3.3T	9.8G	3.3T	1%	/archive
nas1:/dataARCHIVER	1.1T	8.9G	1.1T	1%	/data/archiver
nas1:/aiidata	537G	65G	473G	12%	/awips2/edex/data
nas1:/verify	2.2T	5.7G	2.2T	1%	/data/verify
nas1:/GFESuite2	11G	2.5G	8.3G	24%	/awips2/GFESuite

**Note:** Check to see if everything is mounted (/awips2, /data\_store, /awips2/edex/data/hdf5)

2. Check to see whether the Heartbeat, a2px2apps, and px2f up (ping px2f) are running.
3. Check to see whether the Rehosted applications are running.

**TYPE:** `ps -ef | grep ldad`

```
ldad      760      1  0 Oct13 ?          00:00:05
/awips/fxa/bin/CommsRouter LDAD_ROUTER
ldad      768      1  0 Oct13 ?          00:00:05
/awips/fxa/bin/DataController LDAD_ROUTER LdadController.config
ldad      771     768  0 Oct13 ?          00:00:13
/awips/fxa/bin/routerLdadDecoder px2-tbw3/56457/768 136938768
ldad      772     768  0 Oct13 ?          00:00:31
/awips/fxa/bin/routerStoreNetcdf px2-tbw3/56457/768 136965408
ldad      773     768  0 Oct13 ?          00:00:19
/awips/fxa/bin/routerStoreEDEX px2-tbw3/56457/768 136974328
ldad      774     768  0 Oct13 ?          00:00:42
/awips/fxa/bin/routerShefEncoderEDEX px2-tbw3/56457/768 136974552
ldad      775     768  0 Oct13 ?          00:01:07
/awips/fxa/bin/routerStoreTextEDEX px2-tbw3/56457/768 136974856
ldad     1207      1  0 Oct13 ?          00:00:37 /bin/sh
/awips/ldad/bin/watchDogInternal.sh
ldad     26284  1207  0 17:43 ?          00:00:00 sleep 30
root     26286 26159  0 17:43 pts/1    00:00:00 grep ldad
perl /awips/ldad/bin/pollForData.pl Start
/awips/ldad/data/pollForData.conf
fxa     31767      1  0 Oct13 ?          00:00:00
/awips/fxa/bin/ldadServer
ldad     32762      1  0 Oct13 ?          00:00:01
/awips/ldad/bin/listener
```

**TYPE:** `ps -ef|grep fxa`

```
fxa      469      1  0 Oct30 ?          00:00:00 /bin/sh
/awips/fxa/FSIedex/bin/fsiWatchdog.sh
fxa      471     469  0 Oct30 ?          00:11:49
/awips/fxa/FSIedex/bin/FSIprocessorEDEX
fxa      808      1  0 Oct30 ?          00:00:00
/awips/fxa/fsi/bin/rssd
```



```

ldad      2419      1  0 Oct30 ?      00:00:17
/awips/fxa/bin/CommsRouter LDAD_ROUTER
ldad      2427      1  0 Oct30 ?      00:00:07
/awips/fxa/bin/DataController LDAD_ROUTER LdadController.config
ldad      2430     2427  0 Oct30 ?      00:01:13
/awips/fxa/bin/routerLdadDecoder px2-hgx/42989/2427 167269768
ldad      2431     2427  0 Oct30 ?      00:10:51
/awips/fxa/bin/routerStoreNetcdf px2-hgx/42989/2427 167296408
ldad      2432     2427  0 Oct30 ?      00:01:50
/awips/fxa/bin/routerStoreEDEX px2-hgx/42989/2427 167305328
ldad      2433     2427  0 Oct30 ?      00:00:00
/awips/fxa/bin/routerShefEncoderEDEX px2-hgx/42989/2427 167305552
ldad      2434     2427  0 Oct30 ?      00:00:00
/awips/fxa/bin/routerStoreTextEDEX px2-hgx/42989/2427 167305856
root      14089 13693  0 15:42 pts/1    00:00:00 grep fxa
fxa       26795      1  0 Oct16 ?      00:00:00
/awips/fxa/bin/ldadServer
fxa       29944      1  0 Oct22 ?      00:00:00 avnpython
/awips/adapt/avnfps/OB9.2/py/avninit.py px2f
fxa       30092 29944  0 Oct22 ?      00:01:20 avnpython
/awips/adapt/avnfps/OB9.2/py/avnserver.py -d -n px2f
fxa       30101 29944  0 Oct22 ?      00:00:01 avnpython
/awips/adapt/avnfps/OB9.2/py/avndrs.py -d -n px2f
fxa       30125 29944  0 Oct22 ?      00:01:51 avnpython
/awips/adapt/avnfps/OB9.2/py/avndis.py -d -n px2f
fxa       30131 29944  0 Oct22 ?      00:00:19 avnpython
/awips/adapt/avnfps/OB9.2/py/avnxs.py -d -n px2f
fxa       30145      1  0 Oct22 ?      00:49:51
/awips/adapt/avnfps/gamin-0.1.10/libexec/gam_server

```

## Workstations

1. Check for System Issues – Full partitions, load average, etc.

```

TYPE:      df -H
TYPE:      top
TYPE:      df /awips2/edex/data/share

```

2. Ensure that the directory is mounted from the nas1:aiidata/share as shown below:

```

[root@pxl1-tbw3 ~]# df /awips2/edex/data/share
Filesystem            1K-blocks      Used Available Use% Mounted on
nas1:/aiidata/share  527556704    4756032 522800672   1%
/awips2/edex/data/share

```

```

TYPE:      df /data/verify

```

3. Ensure that the directory is mounted from the nas1:verify as shown below:

```
[root@px1-tbw3 ~]# df /data/verify
Filesystem            1K-blocks      Used Available Use% Mounted on
nas1:/verify          1006233440    519968 1005713472   1% /data/verify
```

4. Ensure that AlertViz launches and does not ask for localization server.
5. Ensure that CAVE launches and products load.
6. Ensure that GFE launches within CAVE and that grids are available.
7. Ensure that WarnGen launches and that templates are available.
8. Ensure that AvnFPS launches and that data is available.
9. Ensure that Text Workstation launches on the XT.
10. Ensure that you can issue a textdb -r command from a terminal window.

### ***1.11.2 All Machines***

1. Ensure that DNS is working.

**TYPE: dig as3-ancf**

2. Ensure that NIS is working.

**TYPE: ypcat hosts**

3. Ensure that NTP working.

**TYPE: ntpq**

**TYPE: pe**

**ntpq> pe**

```
remote          refid          st t when poll reach  delay  offset  jitter
=====
*165.92.30.82   .CDMA.         1 u  138 1024  377   17.392   0.057   0.548
+165.92.180.82 .CDMA.         1 u  168 1024  377   32.069  -0.142   3.829
LOCAL(0)       .LOCL.        10 l  13   64  377    0.000   0.000   0.001
```

## **Appendix J**

### **WarnGen Templates**

## Appendix J. WarnGen Templates

### Table of Contents

	<i>Page</i>
J.1 OB16.2.2 WarnGen Template Activation.....	1
J.2 WarnGen Template Overview .....	1
J.3 WarnGen Templates: AWIPS I / AWIPS II Equivalent.....	2
J.4 Auxiliary WarnGen Template Files .....	5
J.5 Template Language and Documentation .....	7
J.5.1 Troubleshooting WarnGen Startup .....	7

### List of Tables

Table J.3-1. WarnGen Severe Weather Product Templates.....	3
Table J.3-2. WarnGen Marine Weather Product Templates .....	3
Table J.3-3. WarnGen Hydrologic Product Templates .....	3
Table J.3-4. WarnGen Non-Warning Product Templates.....	4
Table J.3-5. WarnGen Impact-Based Warning (IBW) Templates .....	4

### ***J.1 OB16.2.2 WarnGen Template Activation***

Release OB16.2.2 delivers various mixed case WarnGen Template changes. Please refer to the AWIPS Software Installation Note 106, AWIPS Release 16.2.2, Section A.4.4, for details.

After the OB16.2.2 install, WarnGen should be tested in workstation PRACTICE mode. Be sure to test a full warning lifecycle for each product. For example, complete the following for every WarnGen product issued at the office. Verify that all geographic processing and template formatting work correctly:

1. Issue a new warning for several counties.
2. Issue a correction.
3. For hydrologic products, issue an extension in time.
4. Issue a follow-up statement partial cancellation (cancel one or more counties and continue the warning in other counties.)
5. Issue a follow-up statement continuation.
6. Issue a follow-up statement cancellation.
7. Issue follow-up statement expiration.

### ***J.2 WarnGen Template Overview***

The templates described in this appendix will streamline WarnGen operations and simplify WarnGen template maintenance. Template Team members are continually updating detailed information about WarnGen templates on the AWIPS Migration wiki at the following URL:

<https://collaborate.nws.noaa.gov/trac/siteconfig/wiki/WarnGen>.

In AWIPS I: Generation configuration files were spread across several files, most notably `wwaConfig.template` and `wwaConfig.txt`, which controlled the menu configuration of the WarnGen GUI, office IDs, backup offices, and more. These files were then "processed" via localization scripts for use by WarnGen and the product templates. It is important to note the location and contents of these files for migration to AWIPS II.

[XXX-]mainConfig.txt :

Found in `/data/fxa/customFiles` or `/awips/fxa/data/localization/XXX/`

Where XXX (optional) is the site identifier for the AWIPS system.

[XXX-]wwaConfig.txt :

Found in `/data/fxa/customFiles` or `/awips/fxa/data/localization/XXX/`

Where XXX (optional) is the site identifier for the AWIPS system.

[XXX-]wwaConfig.template :

Found in /data/fxa/customFiles or /awips/fxa/data/localization/XXX/

Where XXX (optional) is the site identifier for the AWIPS system.

In AWIPS II: AWIPS II streamlines a lot of the above functionality, while making it wholly more intuitive. General WarnGen configuration is now set in the **config.xml** and **config.vm** files ([ConfigInfo](#)). config.xml controls the [WarnGen](#) GUI (available products, WFOs, etc...), while config.vm contains global settings specific to the [WarnGen](#) text output. Both of these files are found in:

**\$EDEX\_HOME/data/utility/common\_static/base/warngen** directory on dx3/dx4 where \$EDEX\_HOME is typically /awips2/edex. Files are edited via the Localization Perspective within CAVE, which places copies in **\$EDEX\_HOME/data/utility/common\_staic/site/XXX/warngen** where XXX is the three-letter id of the WFO (eg. LWX or CTP).

To edit config.xml or config.vm

1. Open the localization perspective in CAVE.
2. Under the **D2D** and then the **warngen** tree folders, right click on the BASE config.xml and do a **copy to site (XXX)** where XXX is your active site ID. Depending on your ADAM workstation installation/migration, a site level copy may already be present.
3. If not, you should now see a new copy of config.xml with a SITE(XXX) tag to it. A baseline copy of config.xml is copied to the local site folder described above.
4. Double click this file to edit it in the editor. Future edits are made to the SITE level copy.
5. An example config.xml is contained within the baseline file and should be very useful for customizing the WarnGen GUI as well as the primary/backup WFO nomenclature and IDs. Save your edits when done. [**Note:** The concept above applies to editing ALL customizable WarnGen configuration files and templates. NOTE: You will need to restart CAVE and D2D to enact any changes made to config.xml. Any other changes to template xml or vm files can be immediately viewed by simply reloading WarnGen on your D2D.

### **J.3 WarnGen Templates: AWIPS I / AWIPS II Equivalents**

Tables J.3-1 – J.3-5 list the templates for AWIPS I and their equivalents in AWIPS II.

**Table J.3-1. WarnGen Severe Weather Product Templates**

Warning	AWIPS I Templates	AWIPS II Files
Tornado Warning - PIL: TOR, e.g. STLTORREAX	wwa_tor.preWWA	tornadoWarning.vm <b>and</b> tornadoWarning.xml
Severe Thunderstorm Warning - PIL: SVR, e.g., STLSVREAX	wwa_svr.preWWA	severeThunderstormWarning.vm <b>and</b> severeThunderstormWarning.xml
Severe Weather Statement, follow-up to TOR or SVR - PIL: SVS, e.g., STLSVSEAX	wwa_svrwx_sta_county.preWWA	severeWeatherStatement.vm <b>and</b> severeWeatherStatement.xml
Extreme Wind Warning - PIL: EWW, e.g., MIAEWWMFL	wwa_eww.preWWA	extremeWindWarning.vm <b>and</b> extremeWindWarning.xml
Severe Weather Statement, follow-up to EWW - PIL: SVS, e.g., MIASVSMFL	wwa_eww_svs.preWWA	extremeWindWarningFollowup.vm <b>and</b> extremeWindWarningFollowup.xml

**Table J.3-2. WarnGen Marine Weather Product Templates**

Warning	AWIPS I Templates	AWIPS II Files
Special Marine Warning - PIL: SMW, e.g., BOSSMWBOX	wwa_specmarine.preWWA	specialMarineWarning.vm <b>and</b> specialMarineWarning.xml
Marine Weather Statement, follow-up to SMW - PIL: MWS, e.g., BOSMWSBOX	wwa_mar_wx_sta.preWWA	specialMarineWarningFollowup.vm <b>and</b> specialMarineWarningFollowup.xml
Standalone Marine Weather Statement - PIL: MWS, e.g., WBCMWSLWX	wwa_mws_nosmw.preWWA	marineWeatherStatement.vm <b>and</b> marineWeatherStatement.xml
Standalone Marine Weather Statement for Ashfall - PIL: MWS, e.g., ANCMWSAFC	NA - Alaska region	marineWeatherStatementAshfall.vm <b>and</b> marineWeatherStatementAshfall.xml

**Table J.3-3. WarnGen Hydrologic Product Templates**

Warning	AWIPS I Templates	AWIPS II Files
Flash Flood Warning (convective) - PIL: FFW, e.g., STLFFWSGF	wwa_ffw.preWWA	flashFloodWarning.vm <b>and</b> flashFloodWarning.xml  ALASKA: flashFloodWarning_Zones.vm <b>and</b> flashFloodWarning_Zones.xml
Flash Flood Statement (follow-up to convective FFW) - PIL: FFS, e.g., STLFFSSGF	wwa_fflood_sta_county.preWWA	flashFloodWarningFollowup.vm <b>and</b> flashFloodWarningFollowup.xml

Warning	AWIPS I Templates	AWIPS II Files
Burn Scar Flash Flood Warning (convective) – PIL: FFW, e.g., DENFFWBOU	NA	burnScarflashFloodWarning.vm and burnScarflashFloodWarning.xml
Burn Scar Statement (follow-up to burn scar FFW) – PIL: FFS, e.g., DENFFSBOU	NA	burnScarflashFloodWarningFollowup.vm and burnScarflashFloodWarningFollowup.xml
Non-Convective Flash Flood Warning (incl. Dam Break) - PIL: FFW, e.g., OMAFFWOAX	wwa_dam_break.preWWA	nonConvectiveFlashFloodWarning.vm <b>and</b> nonConvectiveFlashFloodWarning.xml
Non-Convective Flash Flood Statement (incl. Dam Break) - PIL: FFS, e.g., OMAFFSOAX	wwa_flflood_sta.preWWA	nonConvectiveFlashFloodWarningFollowup.vm <b>and</b> nonConvectiveFlashFloodWarningFollowup.xml
Areal Flood Warning - PIL: FLW, e.g., WBCFLWLWX	wwa_flood_wrn.preWWA	arealFloodWarning.vm <b>and</b> arealFloodWarning.xml
Areal Flood Statement (follow-up to FLW) - PIL: FLS, e.g., WBCFLSLWX	wwa_flood_sta.preWWA	arealFloodWarningFollowup.vm <b>and</b> arealFloodWarningFollowup.xml
Areal Flood Advisory (events below severe criteria) - PIL: FLS, e.g., STLFLSSGF	wwa_flood_adv.preWWA	arealFloodAdvisory.vm <b>and</b> arealFloodAdvisory.xml
Areal Flood Advisory Statement (follow-up to areal flood advisory) - PIL: FLS, e.g., STLFLSSGF	wwa_flood_adv_sta.preWWA	arealFloodAdvisoryFollowup.vm <b>and</b> arealFloodAdvisoryFollowup.xml

Table J.3-4. WarnGen Non-Warning Product Templates

Non-Warning	AWIPS I Templates	AWIPS II Files
Significant Weather Advisory - PIL: SPS, e.g., STLSPSEAX	wwa_swa.preWWA (in /data/fxa/customFiles or /awips/fxa/data/localization/XXX)	significantWeatherAdvisory.vm <b>and</b> significantWeatherAdvisory.xml
Short Term Forecast - PIL: NOW, e.g., WBCNOWLWX	wwa_shorttermfcst.preWWA	shortTermForecast.vm <b>and</b> shortTermForecast.xml
Special Weather Statement for near-severe Thunder, Snow Squalls, Black Ice, etc... - PIL: SPS, e.g., WBCSPSLWX	wwa_sws.preWWA	specialWeatherStatement.vm and specialWeatherStatement.xml

Table J.3-5. WarnGen Impact-Based Warning (IBW) Templates

Warning	AWIPS I Templates	AWIPS II Files
Tornado Warning - PIL: TOR, e.g., STLTOREAX	wwa_impact_tor.preWWA	impactTornadoWarning.vm <b>and</b> impactTornadoWarning.xml



Warning	A WIPS I Templates	A WIPS II Files
Severe Thunderstorm Warning - PIL: SVR, e.g., STLSVREAX	wwa_impact_svr.preWWA	impactSevereThunderstormWarning.vm <b>and</b> impactSevereThunderstormWarning.xml
Severe Weather Statement, follow-up to TOR or SVR - PIL: SVS, e.g., STLSVSEAX	wwa_impact_svs.preWWA	impactSevereWeatherStatement.vm <b>and</b> impactSevereWeatherStatement.xml
Special Marine Warning: PIL: SMW, e.g., ARBSMWDTX	wwa_impact_smw.preWWA	impactSpecialMarineWarning.vm <b>and</b> impactSpecialMarineWarning.xml
Marine Weather Statement, follow-up to SMW - PIL: MWS, e.g., ARBMWSDTX	wwa_impact_mws.preWWA	impactSpecialMarineWarningFollowup.vm <b>and</b> impactSpecialMarineWarningFollowup.xml

#### J.4 Auxiliary WarnGen Template Files

You will likely note additional files in the AWIPS II WarnGen directory, some of which may be edited. Others are part of the baseline.

- The baseline files (found in \$EDEX\_HOME/data/utility/common\_static/base/warngen) are:
  - countyTypes.txt.** A translational table to create proper county/zone/independent city wording.
  - states.txt.** A translational table of state abbreviations.
  - officeCityTimezone.txt** - Raytheon file, containing time zones for WFOs that own counties in multiple time zones.
  - immediateCauses.txt.** Used for text locking of the hydro VTEC immediate causes.
  - marineZoneWording.xml.** Used to code severe weather watch information for marine zones.
  - VM\_global\_library.** A Velocity template repository houses functions that are used repeatedly through the WarnGen templates. If you find a #functionname(args) like syntax and cannot figure out what it does, chances are that the referenced function is contained here.
- The editable files (found in \$EDEX\_HOME/data/utility/common\_static/site/XXX/warngen) are:
  - config.xml** - Global WarnGen configuration file similar to wwaConfig.template in A1. Controls the WarnGen GUI behavior in terms of WFOs and available products.
  - config.vm** - Created by Evan Bookbinder (WFO PBZ), this configuration file contains global settings that pertain to WarnGen text output.
  - geospatialConfig\_COUNTY.xml** - Created by Evan Bookbinder (WFO PBZ), this global configuration file contains all the geographical/spatial settings for

FIPS/COUNTY-BASED products to instruct WarnGen how to intersect the warning polygon, dot and storm track with the various location, state, county shapefiles. WarnGen Velocity Documentation attached explains all the various settings. This file is typically appended via a #include statement to each county-based product's xml configuration.

- **geospatialConfig\_ZONE.xml** - Created by Evan Bookbinder (WFO PBZ), this global configuration file contains all the geographical/spatial settings for ZONE-BASED products to instruct WarnGen how to intersect the warning polygon, dot and storm track with the various location, state, zone shapefiles. WarnGen Velocity Documentation attached explains all the various settings. This file is typically appended via a #include statement to each zone-based product's xml configuration.
- **geospatialConfig\_MARINE.xml** - Created by Evan Bookbinder (WFO PBZ), this global configuration file contains all the geographical/spatial settings for MARINE-BASED products to instruct WarnGen how to intersect the warning polygon, dot and storm track with the various location and marine zone shapefiles. WarnGen Velocity Documentation attached explains all the various settings. This file is typically appended via a #include statement to each marine-based product's xml configuration
- **dupCounties.vm**. An import file to assist those sites that have same-named counties across two states. Similar to a patch placed in AWIPS I to produce correct text output.
- **damInfo.vm**. Created to assist users in creating local dam information for the non-convective Flash Flood Warning/Statement. For more information, see the following WarnGen wiki page:  
<https://collaborate.nws.noaa.gov/trac/siteconfig/wiki/SiteSpecificDams>
- **damInfoBullet.xml** and **damInfoBulletName.xml**. Used in conjunction with damInfo.vm to create bullets that is displayed in the WarnGen GUI through the accompanying non-convective Flash Flood Warning/Statement XML files.
- **burnScarInfoBullet.xml** and **burnScarInfoBulletName.xml**. Used in conjunction with burnScarInfo.vm to create bullets that are displayed in the WarnGen GUI through the accompanying burn scar Flash Flood [Warning/Statement](#) XML files.
- **MileMarkers.vm** and **mileMarkers.xml**. The XML file creates WarnGen objects from the mile markers tables in the AWIPS II database. The importMarkersInfo.sh script must be used to import AWIPS I mile markers into AWIPS II. This XML file is referenced via an "include" statement in each WarnGen template's XML configuration file. The VM file logic creates the actual mile marker text. This VM file is referenced via a "parse" statement in each WarnGen template's Velocity .vm file For more information, see the following WarnGen wiki page:  
<https://collaborate.nws.noaa.gov/trac/siteconfig/wiki/AddingMileMarkers>

- **pointMarkers.vm and pointMarkers.xml.** These files are used to define temporary events such as sporting venues or fairs that can be referenced in WarnGen products. They function in a similar manner to the mileMarkers files. For more information, see the following WarnGen wiki page:  
<https://collaborate.nws.noaa.gov/trac/siteconfig/wiki/AddingPointMarkers>
- **forecasterName.vm.** vm code that will help assign a warning forecaster name to warnings automatically. Must be customized to create local user's desired moniker (name, initials, number, etc.). This auxiliary vm file is then referenced (if desired) via a "parse" statement added to each WarnGen template's Velocity .vm file.
- **marineCombo.vm.** Logic that can be customized to combine and shorten adjacent marine zone names. For more information, see the following WarnGen wiki page:  
<https://collaborate.nws.noaa.gov/trac/siteconfig/wiki/CombiningMarineZones>
- **area.suppress.** Specific counties can be configured to suppress North/South and/or East/West wording. Details are contained within the file.

## ***J.5 Template Language and Documentation***

WarnGen templates are created using velocity template language (VTL) with supporting configurations in an xml formatted file with an .xml extension. More information on this can be found at: [http://svn.apache.org/repos/asf/velocity/engine/tags/V\\_1\\_0\\_1/docs/vtl-reference-guide.html](http://svn.apache.org/repos/asf/velocity/engine/tags/V_1_0_1/docs/vtl-reference-guide.html) and <http://click.sourceforge.net/docs/velocity/vtl-reference-guide.html>. Refer to the following wiki page for more information on WarnGen documentation:

[https://collaborate.nws.noaa.gov/trac/siteconfig/attachment/wiki/WarnGen/AWIPS\\_2\\_WarnGen\\_Documentation\\_1.3.1.doc](https://collaborate.nws.noaa.gov/trac/siteconfig/attachment/wiki/WarnGen/AWIPS_2_WarnGen_Documentation_1.3.1.doc)

### ***J.5.1 Troubleshooting WarnGen Startup***

This exercise is designed to familiarize you with troubleshooting CAVE applications by launching via the command line and searching through logs.

#### **Exercise Procedure**

AWIPS II has reengineered the WarnGen application into CAVE. While GUI launches the GUI in the same as launches in AWIPS I, the mechanics behind the processes are different. There are configuration files for the GUI, as well as the templates. This exercise walks through the process of identifying and correcting a problem in site data configuration.

1. Log into your AWIPS workstation. AlertViz should start automatically.
2. Open the AWIPS Menu and select 'Start CAVE (1x) / TextWS (xt).

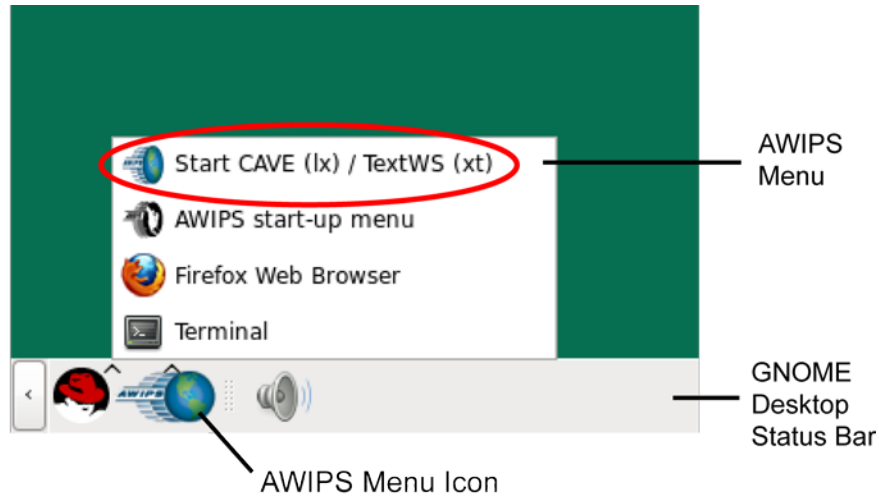

3. Change scales by selecting 'WFO' from the "Map Scale" pulldown menu.

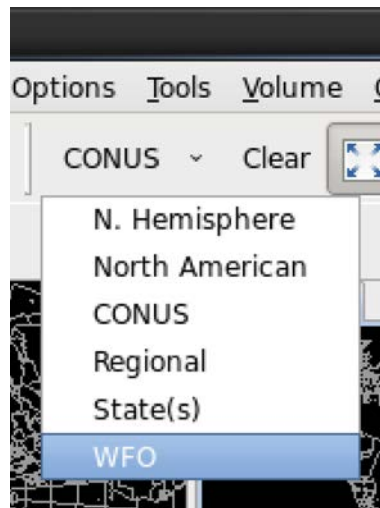

4. Start WarnGen by selecting the "Yellow" button in the upper right corner of the CAVE D2D Perspective.

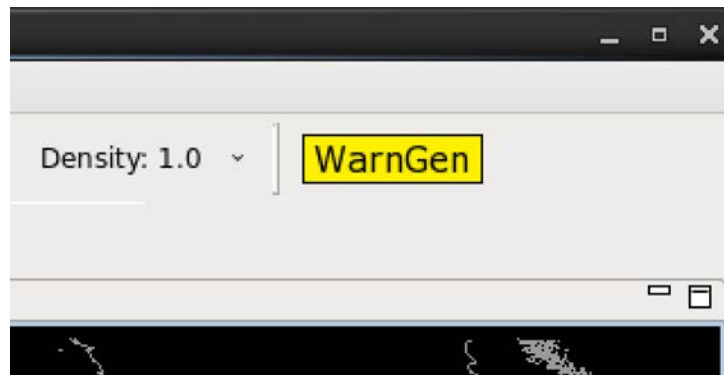

5. You should have received an AlertViz popup after depressing the "WarnGen" button. The error inside the message should be "Failed to initialized map tool".

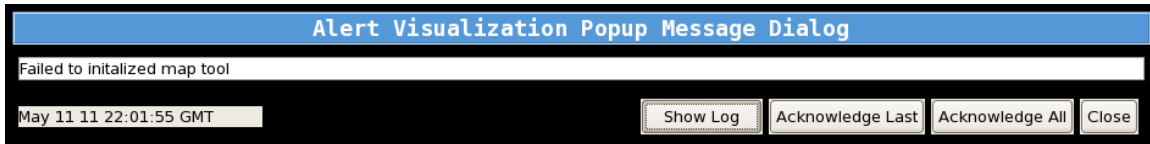

6. Select the 'Show Log' button so that the message log appears below the AlertViz popup and double click on the line with the failure message shown in the screen capture in step 5.
7. You should see an additional window appear on the AlertViz popup with the following text. Review the java exception error on your screen.

```
Failed to initalized map toolcom.raytheon.uf.viz.core.exception.VizException:
Failed to initialize a Tool Resource
    at
com.raytheon.viz.awipstools.ui.display.AwipsToolsResourceData.construct(AwipsT
oolsResourceData.java:132)
    at
com.raytheon.viz.awipstools.ui.action.AbstractMapToolAction.getResource(Abstra
ctMapToolAction.java:103)
    at
com.raytheon.viz.warngen.gui.WarngenAction.getResource(WarngenAction.java:82)
    at
com.raytheon.viz.warngen.gui.WarngenAction.getResource(WarngenAction.java:1)
    at
com.raytheon.viz.awipstools.ui.action.AbstractMapToolAction.execute(AbstractMa
pToolAction.java:75)
    at
org.eclipse.ui.internal.handlers.HandlerProxy.execute(HandlerProxy.java:293)
    at org.eclipse.core.commands.Command.executeWithChecks(Command.java:476)
    at
org.eclipse.core.commands.ParameterizedCommand.executeWithChecks(Parameterized
Command.java:508)
    at
org.eclipse.ui.internal.handlers.HandlerService.executeCommand(HandlerService.
java:169)
    at
org.eclipse.ui.internal.handlers.SlaveHandlerService.executeCommand(SlaveHandl
erService.java:241)
    at
org.eclipse.ui.menus.CommandContributionItem.handleWidgetSelection(CommandCont
ributionItem.java:820)
    at
org.eclipse.ui.menus.CommandContributionItem.access$19(CommandContributionItem
.java:806)
    at
org.eclipse.ui.menus.CommandContributionItem$5.handleEvent(CommandContribution
Item.java:796)
    at org.eclipse.swt.widgets.EventTable.sendEvent(EventTable.java:84)
    at org.eclipse.swt.widgets.Widget.sendEvent(Widget.java:1258)
    at org.eclipse.swt.widgets.Display.runDeferredEvents(Display.java:3540)
    at org.eclipse.swt.widgets.Display.readAndDispatch(Display.java:3161)
    at org.eclipse.ui.internal.Workbench.runEventLoop(Workbench.java:2640)
    at org.eclipse.ui.internal.Workbench.runUI(Workbench.java:2604)
    at org.eclipse.ui.internal.Workbench.access$4(Workbench.java:2438)
    at org.eclipse.ui.internal.Workbench$7.run(Workbench.java:671)
    at
org.eclipse.core.databinding.observable.Realm.runWithDefault(Realm.java:332)
```

```

    at
org.eclipse.ui.internal.Workbench.createAndRunWorkbench(Workbench.java:664)
    at org.eclipse.ui.PlatformUI.createAndRunWorkbench(PlatformUI.java:149)
    at
com.raytheon.viz.ui.personalities.awips.VizApplication.start(VizApplication.java:233)
    at
org.eclipse.equinox.internal.app.EclipseAppHandle.run(EclipseAppHandle.java:196)
    at
org.eclipse.core.runtime.internal.adaptor.EclipseAppLauncher.runApplication(EclipseAppLauncher.java:110)
    at
org.eclipse.core.runtime.internal.adaptor.EclipseAppLauncher.start(EclipseAppLauncher.java:79)
    at
org.eclipse.core.runtime.adaptor.EclipseStarter.run(EclipseStarter.java:369)
    at
org.eclipse.core.runtime.adaptor.EclipseStarter.run(EclipseStarter.java:179)
    at sun.reflect.NativeMethodAccessorImpl.invoke0(Native Method)
    at
sun.reflect.NativeMethodAccessorImpl.invoke(NativeMethodAccessorImpl.java:39)
    at
sun.reflect.DelegatingMethodAccessorImpl.invoke(DelegatingMethodAccessorImpl.java:25)
    at java.lang.reflect.Method.invoke(Method.java:597)
    at org.eclipse.equinox.launcher.Main.invokeFramework(Main.java:619)
    at org.eclipse.equinox.launcher.Main.basicRun(Main.java:574)
    at org.eclipse.equinox.launcher.Main.run(Main.java:1407)
Caused by: java.lang.reflect.InvocationTargetException
    at sun.reflect.NativeConstructorAccessorImpl.newInstance0(Native Method)
    at
sun.reflect.NativeConstructorAccessorImpl.newInstance(NativeConstructorAccessorImpl.java:39)
    at
sun.reflect.DelegatingConstructorAccessorImpl.newInstance(DelegatingConstructorAccessorImpl.java:27)
    at java.lang.reflect.Constructor.newInstance(Constructor.java:513)
    at
com.raytheon.viz.awipstools.ui.display.AwipsToolsResourceData.construct(AwipsToolsResourceData.java:113)
    ... 36 more
Caused by: java.lang.NullPointerException
    at
com.raytheon.viz.warngen.gui.WarngenLayer.<init>(WarngenLayer.java:219)
    ... 41 more

```

- Click the 'Acknowledge All' button, and minimize CAVE. The WarnGen GUI is configured through site data configuration with an XML file. Perhaps something went wrong? The file would have been transferred to your caveData when you localized, so take a look there first. Open a terminal window by left clicking and selecting 'terminal', and, from the prompt, change into the following directory.

**Enter:**    `cd caveData/configuration/site/LLL/com.raytheon.viz.warngen`

Where LLL is the SITE ID of the system you are using for the exercise.

9. Note the path of the directory you changed to in step 8. It is in a configuration directory, at a site level, and has to do with “viz” and “warngen”. Take a look at the `config.xml` file that is in this directory.

**Enter:** `cat config.xml`

10. XML syntax is a series of tags that start with an opening tag and, at some point, have a closing tag. The closing tag is different from the opening tag only in that it has a “/” character before the name of the tag. For example:

```
<name> Kevin Johnson </name>
```

Scour the text on your screen now and see if you can find any errors in the XML.

11. You should have noted that the `<siteNode>` XML tag has no closing `</siteNode>` tag. You will need to fix this in order for WarnGen to start. Use the `vi` editor.

**Enter:** `cp -a config.xml BAD-config.xml`

**Enter:** `vi config.xml`

Navigate to the line that starts `<siteNode>` and add the string `</siteNode>`, as shown below, after the three letter site node. Now, save the file.

```
<siteNode>OAX</siteNode>
```

**Enter:** `Esc :wq!`

12. Now, maximize your CAVE by selecting it from your task bar list. Once maximized, try to start WarnGen once more.
13. Success! WarnGen will now start! That was the problem. However, you just edited a file in `caveData` to test the change. You know that the file originates in the EDEX Localization Store. It needs to be fixed there in order to handle the site data configuration change properly.
14. Change focus to the terminal window that should be behind the CAVE display. Secure shell into the DX3 or DX4 as user `root` and change into the Localization Store.

**Enter:** `ssh root@dx3`

**Enter:** `cd /awips2/edex/data/utility/cave_config/`

15. The problem file is actually in `site/LLL/com.raytheon.viz.warngen`; however, for the purposes of this exercise you are going to create a user-level file to fix the problem. In a normal situation, a user would not have his, or her, own version of this file. It is important to note that this user version file is only for the purposes of this exercise.

**Enter:** `mkdir -p user/YOURUSERNAME/com.raytheon.viz.warngen`

**Enter:** `chown -R awips:awips user`

**Enter:** `cp -a site/LLL/com.raytheon.viz.warngen/config.xml  
user/YOURUSERNAME/com.raytheon.viz.warngen/`

**Enter:** `cd user/YOURUSERNAME/com.raytheon.viz.warngen`

**Note:** Substitute your user name for YOURUSERNAME above. For example: `mkdir -p user/kevinj/com.raytheon.viz.warngen`.

Notice the similarities to the path in caveData that you originally looked into for the file.

16. Use the *vi* editor to edit the config.xml and fix the `<siteNode>` tag as done above.

17. Once the file has been fixed,

**Enter:** `exit`

18. You need to make sure that the file gets downloaded properly now, so remove the config.xml in your caveData and re-launch CAVE to see if WarnGen will start. In your terminal window, change into the user-level directory to which your file will be downloaded.

**Enter:** `cd  
~/caveData/configuration/user/YOURUSERNAME/com.raytheon.viz.  
warngen`

19. Exit CAVE by selecting 'CAVE → Exit...'

The reason that CAVE must be restarted is that it has already read the corrected file from when you made the local change in step 11. By restarting, you are ensuring a proper file is re-downloaded from EDEX Localization Store.

20. Re-launch CAVE through your left click menu, and once again change scales and start WarnGen via the button. (Reference steps 3 and 4 above.)

WarnGen should have started successfully. In your terminal window, check to see if the file was downloaded.

**Enter:** `ls -l`

You should see that the file has now been downloaded from the EDEX Localization Store. If this was not an exercise, and the site-level file had actually been changed, it would have been downloaded correctly to the site-level directory to ensure that the next forecaster to launch WarnGen would not see the error.



**Appendix K**  
**Reporting Problems to the NCF:**  
**Tips on Completing Trouble Ticket**  
**Worksheets, Describing Slow**  
**Workstation Performance and**  
**Completing the Trouble Ticket**  
**Express form**

**Appendix K. Reporting Problems to the NCF:  
Tips on Completing Trouble Ticket Worksheet,  
Describing Slow Workstation Performance and  
Completing the Trouble Ticket Express form**

**Table of Contents**

	<i>Page</i>
K.1 NCF Trouble Ticket Worksheet.....	1
K.2 AWIPS Workstation Performance (Slowness) During Severe Weather.....	4
K.2.1 AWIPS Tips for Improved System Performance .....	4
K.3 NCF Trouble Ticket Express .....	5

From time to time, you will need to contact the Network Control Facility (NCF) in Silver Spring, Maryland, to report a problem at your site. This appendix is provided to help you give the NCF engineers the information needed to resolve your issue.

The appendix has three sections:

- K.1, which includes a copy of the NCF Trouble Ticket Worksheet and instructions for its use; and
- K.2, which provides additional guidelines for working with the NCF to resolve issues during severe weather. This section also includes tips for avoiding problems during severe weather.
- K.3, which provides guidelines when completing the NCF Trouble Ticket Express form along with a copy of the form.

### ***K.1 NCF Trouble Ticket Worksheet***

The NCF Trouble Ticket Worksheet is a tool designed for your use in reporting a problem at your site. Please keep copies of the worksheet on hand and have the information requested on the worksheet available when you call the NCF to report your problem. Missing or incomplete information can have a negative effect on the resolution process, and increase the time it takes to diagnose and resolve the problem.

A copy of the NCF Trouble Ticket Worksheet and instructions for completing the worksheet appear on the following two pages.

### NCF Trouble Ticket Worksheet

**Note:** The NCF will determine the Severity Code depending on site supplied weather situation (#3) and the problem type encountered (#10)

1. Date: \_\_\_\_\_ Time: \_\_\_\_\_ Trouble Ticket Number: \_\_\_\_\_
2. Site Identification: \_\_\_\_\_ (e.g., TSA for WFO Tulsa, OK)  
(Use ONLY standard NWS office IDs, Emphasize RFC or WFO.)
3. Weather Situation: Critical/Watches/Warnings: \_\_\_\_ Busy: \_\_\_\_ Quiet/Benign: \_\_\_\_
4. NWS Operational Impact Assessment:  
Immediate Fix: \_\_\_\_\_ Routine Fix: \_\_\_\_\_  
Do Not Fix UNTIL NWS Calls Back: \_\_\_\_\_
5. NWS Person Calling: \_\_\_\_\_
6. NWS Senior Forecaster/Senior Hydrologist on Duty: \_\_\_\_\_
7. NCF Contact (Name of NCF Person on Telephone): \_\_\_\_\_
8. NWS Call Back Telephone Number: \_\_\_\_\_
9. NWS Brief Summary of Problem/Symptoms: \_\_\_\_\_  
\_\_\_\_\_  
\_\_\_\_\_

10. Problem Type:

- |                                     |                                                                                                                   |                 |                                 |             |
|-------------------------------------|-------------------------------------------------------------------------------------------------------------------|-----------------|---------------------------------|-------------|
| <u>Data Quality or Availability</u> | A. Radar                                                                                                          | B. Model        | C. Satellite                    | D. LDAD     |
|                                     | E. ALL                                                                                                            | F. NWSTG        | G. Text products                | H. Other    |
| -----                               |                                                                                                                   |                 |                                 |             |
| <u>Software</u>                     | A. CAVE/D2D                                                                                                       | B. Text Editing | C. OH application               | D. CAVE/GFE |
|                                     | E. SCAN                                                                                                           | F. WHFS         | G. EDEXdecoder                  | H. WarnGen  |
|                                     | I. AVNFPS                                                                                                         | J. LDAD         | K. CLIMATE                      | L. HWR      |
|                                     | M. APS                                                                                                            | N. Localization | O. Archive                      | P. Other    |
| -----                               |                                                                                                                   |                 |                                 |             |
| <u>Hardware</u>                     | A. Monitor                                                                                                        | B. Workstations | C. Multiple Workstations        | D. Printer  |
|                                     | E. Terminal Server                                                                                                | F. Tape Drive   | G. LDAD Servers                 | H. CPs      |
|                                     | I. PXs                                                                                                            | J. DXs          | K. Other _____                  |             |
| -----                               |                                                                                                                   |                 |                                 |             |
| <u>Site Cannot</u>                  | A. Prepare/issue watch/warning/forecasts and/or advisories                                                        |                 |                                 |             |
|                                     | B. Collect/distribute mission critical observations                                                               |                 |                                 |             |
| -----                               |                                                                                                                   |                 |                                 |             |
| <u>Network Issues</u>               | A. Impacts AWIPS Functionality                                                                                    |                 | B. Doesn't result in "blackout" |             |
|                                     | C. Other                                                                                                          |                 |                                 |             |
| -----                               |                                                                                                                   |                 |                                 |             |
| <u>Other Issues</u>                 | A. Site customization problem, such as localization or product modification.                                      |                 |                                 |             |
|                                     | B. Customization issue, such as problems arising from development outside the AWIPS baseline                      |                 |                                 |             |
|                                     | C. Administrative support (e.g., Government-furnished software usage questions; routine reports; ad hoc reports). |                 |                                 |             |
|                                     | D. Questions on how to use software.                                                                              |                 |                                 |             |

11. Problem Frequency: \_\_\_\_ First Time Occurrence  
                                   \_\_\_\_ Intermittent - Occurred \_\_\_\_ times over \_\_\_\_ Hours  
                                   \_\_\_\_ Constant - Cannot use to do work
12. NCF Estimated Time to Diagnose/Troubleshoot/Resolve: \_\_\_\_\_
13. NCF Actual Time to Restore: \_\_\_\_\_
14. NWS Initial customer service rating: 1 2 3 4 5
15. Rating after NCF resolved problem/restored system: 1 2 3 4 5  
(NCF rating scale: 1-poor, 2-fair, 3-average, 4-good, 5-excellent.)

**NCF Trouble Ticket Worksheet Instructions**

1. Dates and times should be in universal time coordinate (UTC)/Z.
2. Always ask for a Trouble Ticket number.
3. Use the standard NWS office IDs and emphasize whether you are calling from an RFC or WFO.
4. Indicate your office work situation due to weather. An office may
  - Have benign/quiet weather;
  - Be involved with critical weather, warnings, watches, and related issues; or
  - Be very busy because of past or anticipated significant weather.

**Note:** The NCF will determine the Severity Code depending on site supplied weather situation (No. 3) and the problem type encountered (No. 10).

5. Your impact assessment indicates a priority of attention required. For example, some problems **SHOULD NOT** be worked on by the NCF until the ESA, SOO, DOH, AWIPS Focal Point or office manager has been contacted or is present. In this case, the initial call is to alert the NCF that there is a problem that is pending.
6. The NWS caller's name.
7. The name of the senior person on duty—lead forecaster, senior forecaster, or senior hydrologist. This is especially critical during hours when the ESA, SOO, or AWIPS Focal Point are not available. This references the office POC during nonstandard hours.
8. Name of NCF engineer handling the call. You or the senior duty person may receive a call from another NCF person—please enter the second name.
9. The NCF will verify the NWS number for return calls. Please give the NCF the appropriate number to ensure communication between the NCF and your office is not delayed.
10. Please briefly comment about the problem, describing the symptoms.
11. Problem type should be checked or circled so it can be read to the NCF engineer.

## ***K.2 AWIPS Workstation Performance (Slowness) During Severe Weather***

Your responses to questions as to the performance (slowness) of your CAVE/D2D perspective or your workstation will help the NCF resolve performance problems, especially during severe weather or emergency situations. Please be ready to answer the following questions:

- Is the slowness occurring with a specific display in D2D, or with the workstation as a whole?
- Did your site run through a pre-severe weather checklist?

If the problem is affecting just one display:

- Do you have the Local & Regional Warning Display loaded?
- Do you have the Local Warning Display loaded?
- About what time did the slowness start?
- On which monitor is the pane loaded?
- Does anyone else have this loaded on another CAVE/D2D? If so, are they having problems?
- Is the slowness mainly with restoring a pane that has been put into a side-panel?

If the entire workstation is affected:

- Do you have FSI running? If so, does stopping it help?

### ***K.2.1 AWIPS Tips for Improved System Performance***

With help from the NCF, you may be able to improve system performance during severe weather. To the best of your abilities, several hours before severe weather initiation is anticipated, take the following actions:

1. Call the NCF and request “*an edex restart to prepare for a severe weather event.*” Remind the NCF to restart edex *one at a time*. [**Important:** No grid editing in GFE should be done while the NCF is restarting the edex processes.]
2. Quite likely while on the same call, ask the NCF to open a ‘severe weather’ trouble ticket for your site. Opening the ticket helps put the NCF on notice that you expect to be busy, and this will help the NCF remain alert to system monitoring duties.

**Note:** Actions 1 and 2 should not take long, and usually the NCF is able to start, and maybe even complete, these actions while still on the phone.

3. Notify the NCF by telephone that you are going to reboot your workstations. Then, as timing and duties permit, reboot all workstations, even the ones that may

not currently have been in use. This will ensure all workstations are ready if/when they need to be staffed up.

4. Have extra workstations logged in. In case you need to quickly move to another workstation due to unforeseen problems, you can quickly move to the extra workstation and restart CAVE, procedures, etc.
5. Call or chat with your service backup sites. Give them a friendly reminder that you anticipate severe weather, and that you are on AWIPS II and in OT&E status. You hope you will not need their assistance, but just in case you do, they will not be caught totally caught off guard.

**Note:** The NCF has a “critical weather monitoring” script that it runs after SPC issues a Severe Thunderstorm Watch or Tornado Watch. This action is taken automatically at the NCF as soon as the watch box is issued. This script does not take any site action, but it gives the NCF a good snapshot of how your system is performing. If the NCF needs to take any actions as a result of the script, someone from the NCF will call BEFORE initiating action.

### ***K.3 NCF Trouble Ticket Express***

The NCF Trouble Ticket Express is a tool designed for your use in reporting LOW OR MEDIDUM priority AWIPS2 problems at your site. The NCF Trouble Ticket Express is an online form and can be found at the following URL:

<https://docs.google.com/a/noaa.gov/forms/d/13AKzaJhpnwz0kGqmok1AtHRk8LjudqsayczAf1IDWqE/viewform>

Before you submit the Trouble Ticket Express, be sure to call the NCF to receive a Trouble Ticket number along with the NCF engineer’s name. An example of the online Trouble Ticket form can be found on the following page:

<b>NCF Trouble Ticket Express</b>	
This form is for non-critical issues. You must first call NCF at 301-713-9344. Follow this procedure:	
<ol style="list-style-type: none"> <li>1. Provide your name and site ID.</li> <li>2. Ask for a non-critical trouble ticket to be opened with details to follow via email.</li> <li>3. Fill out the details below.</li> </ol>	
Your username ( <a href="mailto:name.last@noaa.gov">name.last@noaa.gov</a> ) will be recorded when you submit this form. Not name.last? Sign out	
* Required	
Trouble Ticket Number *	
***Mandatory***	
<input type="text"/>	
NCF Engineer *	
***Mandatory***	
<input type="text"/>	
Site ID *	
<input type="text"/>	
AWIPS User ID of person experiencing the problem: (If applicable)	
<input type="text"/>	
General date and time(s) problem occurred (UTC/AWIPS time):	
<input type="text"/>	
Description of Problem *	
If this is a critical issue impeding the issuance of warning products, call the NCF at 301-713-9344 for Immediate assistance!	
<input type="text"/>	
Additional information about the issue This can include location of the screen captures or copy of AlertViz error message	
<input type="text"/>	
If applicable, which D2D procedure, warnGen product, GFE smart tool, etc. was in use when problem occurred?	
<input type="text"/>	
Systems affected or workstation(s) where problem occurred:*	
Other can include text workstations, additional lx workstations and other servers.	
<ul style="list-style-type: none"> <li>o lx1</li> <li>o lx2</li> <li>o lx3</li> <li>o lx4</li> <li>o lx5</li> <li>o EDEX cluster</li> <li>o CPSBN</li> <li>o LDAD</li> <li>o Other:</li> </ul>	
General Category *	
Warngen problem	
<ul style="list-style-type: none"> <li>o GFE problem</li> <li>o CAVE problem</li> <li>o Other software issue</li> <li>o Other hardware issue</li> <li>o Unknown</li> </ul>	
Local actions taken (if known):	
<ul style="list-style-type: none"> <li>o Workstation Rebooted</li> <li>o Ran "capture" on workstation</li> <li>o QPID Restarted</li> <li>o CAVE Restarted</li> <li>o EDEX Restarted</li> <li>o User caveData removed</li> <li>o Other</li> </ul>	
<ul style="list-style-type: none"> <li>o Send me a copy of my responses.</li> </ul>	
Submit	



**Appendix L**  
**LDAD Configuration Samples and**  
**Firewall Architecture**

## Appendix L. LDAD Configuration Samples and Firewall Architecture

### Table of Contents

		<i>Page</i>
L.1	LDAD Wiring Lists .....	1
L.2	LDAD Terminal Server Port Configuration .....	2
L.3	LDAD Modem Configurations .....	3
L.4	Environment Variables .....	7
L.5	AWIPS Firewall Architecture and Configuration.....	8
L.5.1	AWIPS Firewall Architecture .....	8
L.5.2	Firewall Configuration.....	8
L.5.3	LDAD LAN (DMZ) Configuration.....	10
L.5.4	AWIPS LAN Reconfiguration .....	10
L.5.5	Interconnectivity Between the Firewall Zones and Security Policies (Firewall Rules) ....	10
L.5.6	LDAD FAX Troubleshooting .....	13
L.5.7	LDAD Firewall Site Configuration Management.....	13
L.5.8	Csportd: Configuration and Setup .....	14

### List of Tables

Table L.1-1.	LDAD Physical Wiring List.....	1
Table L.1-2.	LDAD Firewall Wiring List .....	2
Table L.2-1.	Port Assignments .....	2
Table L.3-1.	LDAD Modem Configurations .....	3
Table L.4-1.	Environment Variables.....	7
Table L.5.5-1.	Default Firewall Ruleset.....	11

### L.1 LDAD Wiring Lists

Table L.1-1 provides the LDAD physical wiring list. Table L.1-2 provides the AWIPS LDAD firewall wiring list.

**Table L.1-1. LDAD Physical Wiring List**

Category	Cable Type	End Point 1	End Point 2
Network	CAT5 UTP	Terminal Server Ethernet 10/100 Base T	SMC 8024 Port 3
Network	CAT5 UTP	External Gateway Ethernet Plaintree	1 018 Port 4
Network	CAT5 UTP	SMC 1080 Port 8	Firewall exp1
Serial	RJ45-DB25 Male RS232 DTE-DCE	Terminal Server Port 1	Modem Chassis Modem 1
Serial	RJ45-DB25 Male RS232 DTE-DCE	Terminal Server Port 2	Modem Chassis Modem 2
Serial	RJ45-DB25 Male RS232 DTE-DCE	Terminal Server Port 3	Modem Chassis Modem 3
Serial	RJ45-DB25 Male RS232 DTE-DCE	Terminal Server Port 4	Modem Chassis Modem 4
Serial	RJ45-DB25 Male RS232 DTE-DCE	Terminal Server Port 5	Modem Chassis Modem 5
Serial	RJ45-DB25 Male RS232 DTE-DCE	Terminal Server Port 6	Modem Chassis Modem 6
Serial	RJ45-DB25 Male RS232 DTE-DCE	Terminal Server Port 7	Modem Chassis Modem 7
Serial	RJ45-DB25 Male RS232 DTE-DCE	Terminal Server Port 8	Modem Chassis Modem 8
Serial	RJ45-DB25 Male RS232 DTE-DCE	Terminal Server Port 9	Modem Chassis Modem 9
Serial	RJ45-DB25 Male RS232 DTE-DCE	Terminal Server Port 10	Modem Chassis Modem 10
Serial	RJ45-DB25 Male RS232 DTE-DCE	Terminal Server Port 19	DTMF Converter 1
Serial	RJ45-DB25 Male RS232 DTE-DCE	Terminal Server Port 20	DTMF Converter 2
Serial	RJ45-DB25 Male RS232 DTE-DCE	Terminal Server Port 11	Modem Chassis Modem 11
Serial	RJ45-DB25 Male RS232 DTE-DCE	Terminal Server Port 12	Modem Chassis Modem 12
Serial	RJ45-DB25 Male RS232 DTE-DCE	Terminal Server Port 13	Modem Chassis Modem 15
Serial	RJ45-DB25 Male RS232 DTE-DCE	Terminal Server Port 30	Modem Chassis Modem 14
Serial	RJ45-DB25 Male RS232 DTE-DCE	Terminal Server Port 31	LDAD LS2 Console Port
Serial	RJ45-DB25 Male RS232 DTE-DCE	Terminal Server Port 32	LDAD LS3 Console Port
Serial	RJ45-DB25 Male RS232 DTE-DCE	Terminal Server Port 29	LDAD LAN Switch Console Port
Serial	RJ45-DB25 Male RS232 DTE-DCE	ATS Port 39	Modem Chassis Modem 13

**Table L.1-2. LDAD Firewall Wiring List**

Source Device	Source Identifier	Destination Device	Destination Identifier
FW 1	LAN 1	FW/SW1	Port 4
FW 2	LAN 3	LDAD LSW	Port 5
FW/SW 1	Port 1	AWIPS HSW 1	Port 21
FW/SW 2	Port 2	AWIPS HSW 2	Port 21
FW/SW 2	Port 1	AWIPS HSW 1	Port 22
FW/SW 2	Port 2	AWIPS HSW 2	Port 22
FW 1	Console	M & C	Port 38
FW 2	Console	M & C	Port 29
Terminal Server	Port 19	DTMF 1	Port RS232
Terminal Server	Port 20	DTMF 2	Port RS232
FW 1	LAN 4	FW 2	Lan 4

## L.2 LDAD Terminal Server Port Configuration

The LDAD Terminal Server is a Cyclades Alterpath ACS32, which provides an Ethernet interface for connection to the LDAD LAN Switch and 32 serial ports for connections to communication devices such as the modems in the Modem Nest, and Console Management ports such as the LS2/3 Servers. Each port can be configured to a maximum speed of 56 K. The terminal server in an average configuration is used to connect 10 dial-in/dial-out modems (including River Gauge, RRS, and ASOS), , a fax modem, and various console connections.

Port assignments are shown in Table L.2-1.

**NOTE:** The LDAD DL380 server and the LDAD LAN Switch are not included in the table.

**Table L.2-1. Port Assignments**

Port	Function
1	LARC Dial-out
2	HANDAR Dial-out
3	RRS Dial-in
4	RRS Dial-in
5	ASOS Dial-in
6	RRS Dial-in
7	ASOS Dial-in
8	ASOS Dial-in
9	ASOS Dial-in
10	ASOS Dial-in
12	ASOS Dial-in
13	ASOS Dial-in
14	ASOS Dial-in
15	ASOS Dial-in
30	Fax Modem Dial-out

The LDAD terminal server is typically configured with a minimum of 4 IP addresses that is assigned in the address space in which the site LDAD resides. First, a single IP address is used to address the terminal server as a whole. Next, an individual and unique IP address is used to address Port 1, Port 2 and Port 6.

For Port 1, the IP address is named “7e1out” within the LDAD site and is used to access a dial-out port configured properly for communications with older devices that utilize 7-bit even parity communications configurations. LARC gauge communications is one example of this type of communications.

The IP address assigned to Port 2 within the LDAD site is named “8n1out” and is used in much the same way as the Port 1 address. In this case, the modem connected to Port 2 is configured for 8-bit no parity communications. Current modem communications equipment is usually configured in this manner. One example is Campbell gauge communications.

The IP addresses assigned to Port 3, Port 4 and Port 6 are used by dial-in users who wish to establish direct TCP communications via PPP to the LDAD LAN. Usually, only Port 6 will be configured with an IP address for PPP dial-in connections.

### L.3 LDAD Modem Configurations

LDAD modem configurations are presented in Table L.3-1.

**Table L.3-1. LDAD Modem Configurations**

Category	Option	Default Setting	7e1out	8n1out	csportd	PPP/ Interactive
	Test	End Test	Default	Default	Default	Default
Test	Accept Redial	On	*	*	*	*
	LAL Busy Out	Off	On	On	On	On
	Line Select	Dial	Default	Default	Default	Default
	Mode	V.34 Auto	Default	Default	Default	Default
	Auto Type	CCITT	Default	Default	Default	Default
	Low Speed	Bell	Default	Default	Default	Default
	Max Rate	33.6	Default	Default	Default	Default
Modulation	Min Rate	300	Default	Default	Default	Default
	Asymmetric Rate	On	Default	Default	Default	Default
	Fast Call	Off	Default	Default	Default	Default
	Adaptive Rate	On	Default	Default	Default	Default
	Mode Select	Originate	Default	Default	Answer	Answer
	Clock Select	Internal	Default	Default	Default	Default
	Retrain	High BER	Default	Default	Default	Default
	Longspace Disconnect	Off	Default	Default	Default	Default
	PSTN Disconnect	On	Default	Default	Default	Default
Guard Tone	Off	Default	Default	Default	Default	

Category	Option	Default Setting	7e1out	8n1out	esportd	PPP/ Interactive
Restoral	Hold Dial Line	Off	Default	Default	Default	Default
	Data Transfer Mode	Spd Auto Reliable	Default	Default	Default	Default
	EC Buffer	Regular	Default	Default	Default	Default
	Error Correction	V.42	Default	Default	Default	Default
	Data Compression	Enabled	Default	Default	Default	Default
EC/DC	Break	Destruct	Default	Default	Default	Default
	Modem Flow	On	Default	Off	Off	Off
	Disconnect Buffer Delay	Off	Default	Default	Default	Default
	Error Correction Identifier	Default MNP ID	Default	Default	Default	Default
	Select	AT	*	*	*	*
	At Data Format	Async	Default	Default	Default	Default
	V25 Format	Bitsync	*	*	*	*
	NoACU Format	Async	*	*	*	*
	Default Dial	Off	Default	Default	Default	Default
	Manual/Auto Answer	Using S0	Default	Default	Ring #1	Ring #1
	Async Echo	On	Default	Default	Default	Default
Char Length	10	*	*	*	*	
ACU	V25 Char	ASCII	*	*	*	*
	Sync Idle	Char	*	*	*	*
	V25 Response	V25bis	*	*	*	*
	Parity	V25	Even	Space	Space	Space
	AT Msg	Before CD	After CD	After CD	After CD	After CD
	Result Code	Enabled	Orig	Orig	Disable	Disable
	Result Code Format	Verbose	Verbose	Verbose	Verbose	Verbose
	DCE/DTE Rate Display	DTE rate	comm msg	comm msg	comm msg	comm msg
	EC Reliable Msg	Off	Long	Long	Long	Long
	LPDA2 Address	ff	*	*	*	*
	LPDA2 ID	326x	*	*	*	*
	LPDA2 Detection	ff	*	*	*	*
	Call Progress Verbosity	4	Default	Default	Default	Default
	DTE rate	auto	57.6	57.6	300/57600	57.6
	Flow Control	XON/XOFF	RTS/CTS	RTS/CTS	RTS/CTS	RTS/CTS
	Speed Conversion	On	Default	Default	Default	Default
	DTR Control	High	Reset	Reset	Reset	Reset
	RTS Control	High	Normal	Normal	Normal	Normal
CTS Control	Async	High	High	Normal	Normal	
RTS/CTS Delay	0	Default	Default	Default	Default	
DCD Control	High	Wink	Wink	Wink	Normal	

Category	Option	Default Setting	7e1out	8n1out	esportd	PPP/ Interactive
Terminal	RTS/DCD Remote Signaling	Codex	Default	Default	Default	Default
	DCD Loss Disconnect	S10	Default	Default	Default	Default
	DSR	High	Drop on disconnect	Drop on disconnect	Drop on disconnect	Drop on disconnect
	Overspeed	1%	Default	Default	Default	Default
	DTR delay	S25	Default	Default	Default	Default
	Circuit 140 Remote Digital Loopback	Off	Default	Default	Default	Default
	Circuit 141 Local Analog Loopback	Off	Default	Default	Default	Default
	DTE pin 25	Busy	Test	Test	Test	Test
	External Option Set Select	Off	Default	Default	Default	Default
	External Control	Pin 14	Default	Default	Default	Default
	Inactivity Timeout	S30	10 Mins	10Mins	10 Mins	10 Mins
	Jack Type	RJ11C	Default	Default	Default	Default
	DL Tx Level	0	*	*	*	*
	LL Tx Level	0	*	*	*	*
Telco	Line Compensation	Off	On	On	On	On
	Speaker Control	Dialing	Default	Default	Default	Default
	Speaker Volume	Medium	Default	Default	Default	Default
	Network Compensation	Off	Default	Default	Default	Default
	Pause Delay	3 Seconds	Default	Default	Default	Default
	Dial Wait	S7	Default	Default	Default	Default
	Dial Control	Tone	Default	Default	Default	Default
Dialing	Call Timeout	60	Default	Default	Default	Default
	Blind Dial	S6	Default	Default	Default	Default
	Pulse Cycle	40%	Default	Default	Default	Default
	Tone Length	72 msec	Default	Default	Default	Default
Front Panel Security	Password	Disable	Default	Default	Default	Default
	Password Verify	Disable	Default	Default	Default	Default
	Callback	Off	Default	Default	Default	Default
	Remote Num Required	Off	Default	Default	Default	Default
Access Security	Group Password	Disable	*	*	*	*
	Tone	None	Default	Default	Default	Default
	Sim Ringback	Disable	Default	Default	Default	Default
	Dial Restricted	Off	Default	Default	Default	Default
	Override mode	Off	Default	Default	Default	Default
	NC Address	000	Default	Default	Default	Default

Category	Option	Default Setting	7e1out	8n1out	esportd	PPP/ Interactive
Network Control	NC Port Rate	75	Default	Default	Default	Default
	Pass Through	option1	Default	Default	Default	Default
	NC Line Disconnect	Off	Default	Default	Default	Default
Remote Configuration	Remote Access	Enabled	Disable	Disable	Disable	Disable
	Dial Restricted	Off	Default	Default	Default	Default
	Ring Count to Answer On	0:0	Default	Default	Default	Default
	Ring Count	1:0	Default	Default	Default	Default
	Escape Code Character	2:43	Default	Default	Default	Default
	Carriage Return Character	3:13	Default	Default	Default	Default
	Line Feed Character	4:10	Default	Default	Default	Default
	Back Space Character	5:8	Default	Default	Default	Default
	Wait for Dialtone	6:2	Default	Default	Default	Default
	Wait for Data Carrier	7:30	Default	Default	Default	Default
S Register	Pause Delay Value	8:2	Default	Default	Default	Default
(RegNum: Default Val)	Carrier Loss Disconnect Delay	10:15	Default	Default	Default	Default
	DTMF Tone Duration	11:72	Default	Default	Default	Default
	Escape Code Guard Time	12:50	Default	Default	Default	Default
	Test Timer	18:0	Default	Default	Default	Default
	DTR Before Looking Fort DTR	25:5	Default	Default	Default	Default
	RTS/CTS Delay	26:1	Default	Default	Default	Default
	DTE Inactivity Disconnect	30:0	Default	Default	Default	Default
	Disconnect Buffer Delay	38:5	Default	Default	Default	Default
	Access Security Tone Duration	45:5	Default	Default	Default	Default
	Access Security Lead Digit Delay Timeout	46:12	Default	Default	Default	Default
	AC Detect	98:0	Default	Default	Default	Default
	V.32 Training Time	99:0	Default	Default	Default	Default



#### L.4 Environment Variables

The LDAD environment variable values in Table L.4-1 use the Honolulu WFO for site-specific variables such as DEFAULT\_WFO and are valid for user **ldad** on PX2.

**Table L.4-1. Environment Variables**

Variable Name	Value
APPS_DEFAULTS_USER	/awips/hydroapps/.Apps_defaults
CLASSPATH	/awips/ldad/classes
DEFAULT_RFC	ANC
DEFAULT_SITE	HNL
DEFAULT_STATE	HI
FILE_SERVER_DEFAULT_PATHS	+/awips/ldad/data/
FXA_DATA	/data/fxa
FXA_HOME	/awips/fxa
FXA_LOCAL_SITE	HFO
FXA_NATL_CONFIG_DATA	/awips/fxa/data/localization
LDAD_DATA	/data/fxa/LDAD
LDAD_DECODED_DATA	/data/fxa/LDAD/decoded
LDAD_DECODER_SOURCE_DIR	/awips/ldad/src/decoder
LDAD_EXTERNAL_BIN	/ldad/bin
LDAD_EXTERNAL_DATA	/data/ldad
LDAD_EXTERNAL_DATA_REPOSITORY	/data/ldad/hmIngest
LDAD_EXTERNAL_HOME	/ldad
LDAD_EXTERNAL_HOST	ls1
LDAD_EXTERNAL_LOGDIR	/data/logs/ldad
LDAD_EXTERNAL_PUBLIC	/data/ldad/public
LDAD_GATEWAY_SOURCE_DIR	/awips/ldad/src/gateway
LDAD_HOME	/awips/ldad
LDAD_INCOMING	/data/Incoming
LDAD_INTERNAL_BIN	/awips/ldad/bin
LDAD_INTERNAL_CRONTABFILE	/awips/ldad/bin/ldad.crontab
LDAD_INTERNAL_CRONTABS	/awips/ldad/bin/crontabs
LDAD_INTERNAL_DATA	/awips/ldad/data
LDAD_INTERNAL_HOME	/awips/ldad
LDAD_INTERNAL_HOST	PX
LDAD_INTERNAL_LOGDIR	/awips/ldad/logs
LDAD_INTERNAL_SOURCE_DIR	/awips/ldad/src
LDAD_INTERNAL_SYSTEM_CRONTABFILE	/usr/spool/cron/crontabs/ldad
LDAD_LOCAL_TZ	HST10
LDAD_RAWDATA	/data/fxa/LDAD/Raw
LDAD_STORAGE_SOURCE_DIR	/awips/ldad/src/decoder/storage
LOG_DIR	/data/logs/ldad
LOG_PREF	/awips/ldad/.logPref
NEWGATEWAY_DB	ldadgateway
SQLEXEC	sqlrm
UDUNITS_PATH	/awips/ldad/data

## ***L.5 AWIPS Firewall Architecture and Configuration***

AWIPS has upgraded the Local Data Acquisition and Dissemination (LDAD) network firewalls with redundant SSG320M firewalls to enhance AWIPS network security. Each AWIPS site has two firewalls controlled by central configuration manager servers. The central configuration management servers are located at the Network Control Facility (NCF) and the Backup NCF. The Security manager clients are located at the NCF and the Raytheon engineering facility in Silver Spring, MD to support the deployment. As part of the deployment, each regional headquarters will have a Netscreen Security Manager client (NSM) on the PX's. The regional NSM clients will allow the regions to view the configurations of the firewalls at each of their AWIPS sites. Control over the firewall configurations is tiered, with the central configuration management server having ultimate control; the regional NSM clients can view their sites but they are managed from the central server. Individual AWIPS sites (forecast offices) will not have direct control over their own configurations.

This section describes the architecture and functionality of the new AWIPS LDAD SSG 320M firewalls.

### ***L.5.1 AWIPS Firewall Architecture***

The AWIPS Site Firewall architecture sets up three zones:

- Trusted – inside the AWIPS network
- Untrusted – outside AWIPS
- DMZ – LDAD server – 1pair- (ls1).

The DMZ is an additional zone where the NOAA ls1 server is placed. The addition of the DMZ zone solves many issues and adds network security to the architecture.

A limitation of the firewall is that for each internal host on the site AWIPS LAN requiring rlogin/rcp/rsh to the ls1, a policy rule must be created on the firewall. Each such rule for a Trust-to-DMZ host pair uses a unique DMZ IP address for source address translation. This need for a 1:1 address translation from internal AWIPS hosts to the ls1 to handle r-commands would have depleted the pool of available IP addresses in the site local LAN had the DMZ not been added. By creating a DMZ using private addresses, the IP address pool is virtually unlimited (nearly 255 available IP addresses) and the site's local LAN address space is not affected. Additionally, by moving the ls1 server to the DMZ, the ls1 is made potentially more secure from attacks emanating from the site LAN Untrusted zone.

### ***L.5.2 Firewall Configuration***

The new firewalls are configured at AWIPS sites in the following way:

- Ethernet Port 1 on the Firewall connects to the Trust zone (165.92.x.x).

- Ethernet Port 2 connects to the DMZ zone (192.168.1.x).
- Ethernet Port 3 connects to the Untrust zone (site local LAN).
- Ethernet Port 4 connects both firewalls for High Availability (failover).
- ls1-<siteid> IP is a new IP address 192.168.1.10  
3/21/06 B-4
- Source NAT for all **Trust to DMZ** traffic using **DIPs** (dynamic IP address).
- Destination NAT for **DMZ to Trust** (high-port tcp).
- Destination NAT for **Untrust to DMZ** using **MIPs** (mapped IP addresses). [MIPs are similar to proxy arp rules. The Untrust to DMZ interface will proxy arp for the old (original) ls1 IP address, so when ls1 traffic arrives at that interface, the destination address is translated to the new ls1 192.168.1.10 address. Proxy arping is a common technique used on firewalls or routers to make a host (ls1) on one side of the firewall/router appear to be part of the same network as hosts on the other side (site local LAN) of the firewall/router.]
- The MIP is bi-directional so outgoing traffic (DMZ to Untrust) will be handled similarly (192.168.1.10 is translated to the original ls1 IP address).

Exhibit L.5.2-1 shows the LDAD configuration of various test-beds.

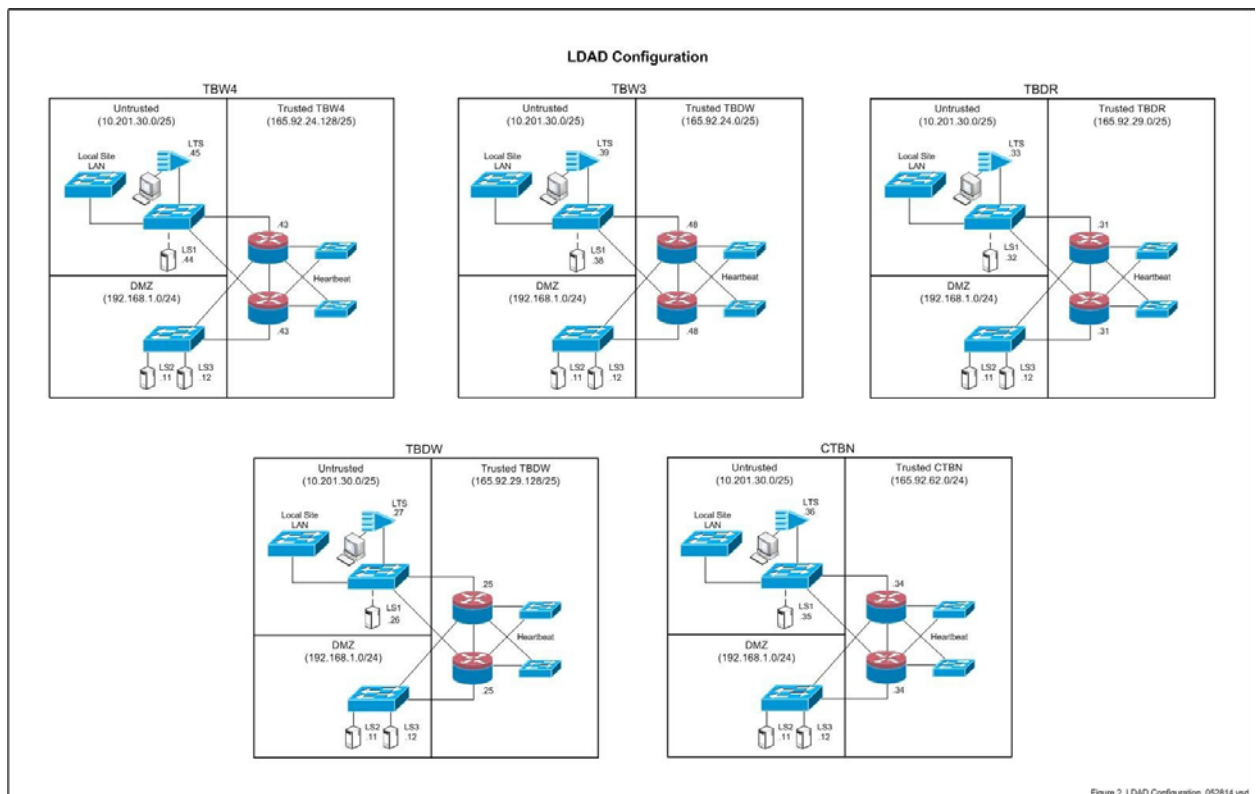

**Exhibit L.5.2-1. LDAD Configuration**

### ***L.5.3 LDAD LAN (DMZ) Configuration***

The LDAD LAN Configuration can be altered as follows:

1. Change ls1 IP to 192.168.1.10.
2. Change gateway to 192.168.1.1.
3. Reconfigure EMDS web server IP address.
4. Add new 192.168.1.x IP addresses to /etc/hosts table for each DIP assigned to an internal 165.92 host. (Needed for rsh/rlogin.)
5. Add 192.168.1.50 for “ds-<siteid>” in hosts table. Needed by MIP rule for DMZ to Trust tcp high-port communication.
6. For each internal AWIPS host that is permitted to rsh/rlogin to the ls1, add the hostname to root’s and ldad’s rhosts file on ls1.
7. Remove all 165.92 addresses from ls1 hosts table and routing table.

**Note:** Aside from ls1, nothing else on the LDAD LAN will be reconfigured during the initial firewall deployment. The LDAD terminal server and modems will function normally.

### ***L.5.4 AWIPS LAN Reconfiguration***

The AWIPS LAN Reconfiguration can be done by adding new ls1 IP address to dx1 hosts table and then pushed out for NIS. On all internal hosts that access ls1, replace the old route to ls1 with a new route to the DMZ (new ls1 DMZ IP address).

### ***L.5.5 Interconnectivity Between the Firewall Zones and Security Policies (Firewall Rules)***

The AWIPS firewall architecture provides for three different zones (Trust, Untrust, and DMZ) and six rules (firewall) as identified below have been established to govern connectivity between two zones:

- **Trust to DMZ**
  - **Two rules** for high-port tcp traffic from DX1 to ls1 (one rule for dx1 and dx2). Uses fixed-port DIP for source address (165.92) translation.
  - **One rule** for ftp/telnet/ssh/http from all internal AWIPS hosts to ls1 (uses egress interface for source address translation).

**Note:** For each internal AWIPS host that requires rsh/rcp/rlogin to ls1, there is one rsh/rcp/rlogin rule for that host to the ls1 (uses dedicated fixed-port DIP for source address translation). For example, if the site AWIPS LAN has 20 such hosts, then 20 DIPS are needed for 20 policy rules.

- **Trust to Untrust**
  - **One rule:** All internal hosts can perform outgoing ftp/telnet/ssh. Uses egress.

- **DMZ to Untrust**
  - *One rule:* All DMZ (ls1) to Untrust traffic allowed.
- **Untrust to DMZ**
  - *One rule:* MIP rule used for destination translation of old (original) ls1 IP address to the new 192.168.1.10 DMZ address. Proxy arp rule. Standard Firewall Ruleset.

Table L.5.5-1 illustrates the default firewall ruleset.

**Table L.5.5-1. Default Firewall Ruleset**

Policy	From Zone	To Zone	Source	Destination	Service	Action	Details
1	Trust	Untrust	\$AWIPS_NET/\$SITE	Any	FTP/Telnet/SSH/HTTP	permit	nat src permit log count
51	Trust	Untrust	\$AWIPS_NET/\$SITE	Any	LDM	permit	nat src permit log count
52	Trust	Untrust	\$AWIPS_NET/\$SITE	Any	Terminal Server	permit	nat src permit log count
2	Trust	Untrust	Any	Any	ANY	deny	deny log alert count
3	Untrust	Trust	Any	Any	ANY	deny	deny log alert count
4	DMZ	Trust	ls1-dmz	MIP(192.168.1.50)	tcp15008	permit	permit log count
49	DMZ	Trust	ls1-servers-dmz	MIP(192.168.1.51)	tcp15008	permit	permit log count
5	DMZ	Trust	Any	Any	ANY	deny	deny log count
6	Trust	DMZ	dx1-\$SITE	ls1-dmz	tcp15007	permit	nat src dip-id 31 permit log count
7	Trust	DMZ	dx2-\$SITE	ls1-dmz	tcp15007	permit	nat src dip-id 32 permit log count
53	Trust	DMZ	\$SITE px Servers	ls1-servers-dmz	tcp15007	permit	nat src dip-id 41 permit log count
8	Trust	DMZ	\$AWIPS_NET/\$SITE	ls1-servers-dmz	FTP/Telnet/SSH/HTTP	permit	nat src permit log count
9	Trust	DMZ	dx1-\$SITE	ls1-dmz	NTP	permit	nat src dip-id 40 permit log count
10	Trust	DMZ	dx2-\$SITE	ls1-dmz	NTP	permit	nat src dip-id 40 permit log count
11	Trust	DMZ	dx1-\$SITE	ls1-dmz	RSH/RCP/RLOGIN	permit	nat src dip-id 4 permit log count
12	Trust	DMZ	dx2-\$SITE	ls1-dmz	RSH/RCP/RLOGIN	permit	nat src dip-id 5 permit log count
13	Trust	DMZ	dx1-\$SITE	ls1-servers-dmz	RSH/RCP/RLOGIN	permit	nat src dip-id 6 permit log count
14	Trust	DMZ	dx2-\$SITE	ls1-servers-dmz	RSH/RCP/RLOGIN	permit	nat src dip-id 7 permit log count
54	Trust	DMZ	dx3-\$SITE	ls1-dmz	RSH/RCP/RLOGIN	permit	nat src dip-id 42 permit log count
55	Trust	DMZ	dx4-\$SITE	ls1-dmz	RSH/RCP/RLOGIN	permit	nat src dip-id 43 permit log count

Policy	From Zone	To Zone	Source	Destination	Service	Action	Details
15	Trust	DMZ	px1-\$\$SITE	ls1-servers-dmz	RSH/RCP/RLOGIN	permit	nat src dip-id 8 permit log count
16	Trust	DMZ	px2-\$\$SITE	ls1-servers-dmz	RSH/RCP/RLOGIN	permit	nat src dip-id 9 permit log count
17	Trust	DMZ	ax-\$\$SITE	ls1-dmz	RSH/RCP/RLOGIN	permit	nat src dip-id 10 permit log count
19	Trust	DMZ	lx1-\$\$SITE	ls1-dmz	RSH/RCP/RLOGIN	permit	nat src dip-id 11 permit log count
20	Trust	DMZ	lx2-\$\$SITE	ls1-dmz	RSH/RCP/RLOGIN	permit	nat src dip-id 12 permit log count
21	Trust	DMZ	lx3-\$\$SITE	ls1-dmz	RSH/RCP/RLOGIN	permit	nat src dip-id 13 permit log count
22	Trust	DMZ	lx4-\$\$SITE	ls1-dmz	RSH/RCP/RLOGIN	permit	nat src dip-id 14 permit log count
23	Trust	DMZ	lx5-\$\$SITE	ls1-dmz	RSH/RCP/RLOGIN	permit	nat src dip-id 15 permit log count
24	Trust	DMZ	lx6-\$\$SITE	ls1-dmz	RSH/RCP/RLOGIN	permit	nat src dip-id 16 permit log count
40	Trust	DMZ	lx7-\$\$SITE	ls1-dmz	RSH/RCP/RLOGIN	permit	nat src dip-id 17 permit log count
41	Trust	DMZ	lx8-\$\$SITE	ls1-dmz	RSH/RCP/RLOGIN	permit	nat src dip-id 18 permit log count
42	Trust	DMZ	lx9-\$\$SITE	ls1-dmz	RSH/RCP/RLOGIN	permit	nat src dip-id 19 permit log count
43	Trust	DMZ	lxa-\$\$SITE	ls1-dmz	RSH/RCP/RLOGIN	permit	nat src dip-id 20 permit log count
44	Trust	DMZ	lxb-\$\$SITE	ls1-dmz	RSH/RCP/RLOGIN	permit	nat src dip-id 21 permit log count
25	DMZ	Untrust	\$DMZ_NET/dm z	Any	ANY	permit	permit log count
26	Untrust	DMZ	Any	MIP(\$LS1)	ANY	permit	permit log count
55	DMZ	Untrust	\$DMZ_NET/dm z	Any	cspord	permit	permit log count
27	Untrust	DMZ	Any	Any	ANY	deny	deny log count
28	DMZ	Untrust	Any	Any	ANY	deny	deny log count
29	Trust	DMZ	xt1-\$\$SITE	ls1-dmz	RSH/RCP/RLOGIN	permit	nat src dip-id 22 permit log count
30	Trust	DMZ	xt2-\$\$SITE	ls1-dmz	RSH/RCP/RLOGIN	permit	nat src dip-id 23 permit log count
31	Trust	DMZ	xt3-\$\$SITE	ls1-dmz	RSH/RCP/RLOGIN	permit	nat src dip-id 24 permit log count
32	Trust	DMZ	xt4-\$\$SITE	ls1-dmz	RSH/RCP/RLOGIN	permit	nat src dip-id 25 permit log count
33	Trust	DMZ	xt5-\$\$SITE	ls1-dmz	RSH/RCP/RLOGIN	permit	nat src dip-id 26 permit log count
34	Trust	DMZ	xt6-\$\$SITE	ls1-dmz	RSH/RCP/RLOGIN	permit	nat src dip-id 27 permit log count
35	Trust	DMZ	xt7-\$\$SITE	ls1-dmz	RSH/RCP/RLOGIN	permit	nat src dip-id 28 permit log count

Policy	From Zone	To Zone	Source	Destination	Service	Action	Details
36	Trust	DMZ	xt8-\$SITE	ls1-dmz	RSH/RCP/RLOGIN	permit	nat src dip-id 29 permit log count
37	Trust	DMZ	xt9-\$SITE	ls1-dmz	RSH/RCP/RLOGIN	permit	nat src dip-id 30 permit log count
38	Trust	DMZ	xta-\$SITE	ls1-dmz	RSH/RCP/RLOGIN	permit	nat src dip-id 33 permit log count
39	Trust	DMZ	xtb-\$SITE	ls1-dmz	RSH/RCP/RLOGIN	permit	nat src dip-id 34 permit log count
45	Trust	DMZ	px3-\$SITE	ls1-dmz	RSH/RCP/RLOGIN	permit	nat src dip-id 35 permit log count
46	Trust	DMZ	px4-\$SITE	ls1-dmz	RSH/RCP/RLOGIN	permit	nat src dip-id 36 permit log count
47	Trust	DMZ	rp1-\$SITE	ls1-dmz	RSH/RCP/RLOGIN	permit	nat src dip-id 37 permit log count
48	Trust	DMZ	rp2-\$SITE	ls1-dmz	RSH/RCP/RLOGIN	permit	nat src dip-id 38 permit log count
50	Trust	DMZ	Any	Any	ANY	deny	deny log count
63	DMZ	Trust	ls1-servers-dmz	dx1-dmz	RSHD	permit	nat dst DX1IP permit log count
64	DMZ	Trust	ls1-servers-dmz	dx2-dmz	RSHD	permit	nat dst DX2IP permit log count
65	DMZ	Trust	ls1-servers-dmz	px1-dmz	RSHD	permit	nat dst PX1IP permit log count
66	DMZ	Trust	ls1-servers-dmz	px2-dmz	RSHD	permit	nat dst PX2IP permit log count

### L.5.6 LDAD FAX Troubleshooting

If there seems to be a problem with the fax queue filling up with unsent faxes (the transmission relies on the firewall), run the faxstat command on the active LS. It is a good sign if the fax queue status is “Running and idle” or “Initializing server” or something like “Sending job 13...”. However, it is likely a bad sign if the fax queue status is “Waiting for modem to come ready...”.

Sometimes the “Waiting for modem to come ready” message appears even in normal operation; however, if the status line continues to say that for several minutes without change, the modem should be re-seated. From the front of the LDAD modem nest, open the panel and locate modem 14; then press on the top and bottom tabs. Once the modem is ejected, firmly press the modem board back into the slot.

### L.5.7 LDAD Firewall Site Configuration Management

All the sites except Raytheon Testbed Silver Spring (ANCF) and Raytheon Testbed Silver Spring (BNCF) are equipped with AWIPS LDAD Firewall Juniper SSG 320M.

- ANCF Raytheon Testbed Silver Spring: AWIPS LDAD Firewall Juniper NSM BASE LIC

- BNCF Raytheon Testbed Silver Spring: AWIPS LDAD Firewall Juniper NSMXPRES HA.

### L.5.8 Csportd: Configuration and Setup

In order to make the LDAD server (LDAD server cluster is a pair of HP ProLiant DL380 G7 Linux servers that act as a primary and hot spare) send and receive data through the terminal server, csportd has been used to serve as a utility that gives users connectivity between the LDAD server and terminal server ports. csportd reads data from stdin, a pseudo terminal, and sends the data to the terminal server port. Likewise, data can be read from the terminal server port and sent to the pseudo terminal.

You will find the csportd executable in /usr/bin, but to start up csportd properly, you need to configure it.

Follow these instructions, based on /ldad/bin/ltsConfig.<siteID> using ports 5 and 7 for ASOS and port 30 for fax:

Example of ltsConfig.wncf:

```
# Filename: ltsConfig.template
#
#   Example configuration file for site WNCF.
#
#
fqdn:          ltserve-wncf.wncf.noaa.gov
ipaddress:     10.201.6.220
subnetMask:    255.255.255.0
broadcastAddress:10.201.6.255
gateway:       10.201.6.4
dns:           10.201.6.1
rloginServer:  10.201.6.216
radiusServer:  10.201.6.216
```

Port	IfType	Misc
----	-----	----
1	7elout	10.201.6.228
2	8nlout	10.201.6.229
# 3	csportd	ASOS
# 4	pppInteractive	10.201.6.231
5	<b>csportd</b>	<b>uArt</b>
6	pppInteractive	10.201.6.230
7	<b>csportd</b>	<b>ASOS</b>
# 8	csportd	ASOS
# 9	csportd	ASOS
#10	csportd	ASOS
#11	csportd	ASOS
#12	csportd	ASOS
#13	csportd	ASOS
#14	csportd	ASOS
#15	csportd	dtmf
#16	csportd	dtmf



```

#17      csportd      dtmf
#18      csportd      dtmf
#19      csportd      dtmf
#20      csportd      dtmf
#21      pppInteractive
#22      pppInteractive
#23      pppInteractive
#24      csportd      ASOS
#25      csportd      uArt_DTE
#26      csportd      DirectASOS
#27      csportd      PCROSA
28       console     LDAD_Sw_Pn1
29       console     llsw-wncf
30       csportd      fax
31       console     ls2-wncf
32       console     ls3-wncf

```

1. Stop csportd on the LS, as user root.  
/etc/ha.d/resource.d/csportd stop
2. Configure /ldad/csportd\_control file.

Example:

```

csportd -d1 -T/dev/faxmodem -s -i ltserv 30 &
sleep 1
chown uucp:uucp /dev/faxmodem
chwrdev /dev/faxmodem

csportd -d1 -T/dev/suamodem1 -s -i -D ltserv 5 &
sleep 1
chwrdev /dev/suamodem1

csportd -d1 -T/dev/suamodem2 -s -i -D ltserv 7 &
sleep 1
chwrdev /dev/suamodem2

echo "Done."
exit 0
;;

```

3. Configure /ldad/data/asosMart.config file.

Example:

```
wncf 5 7
```

**Note:** There should only be one uncommented line in this file, specifying the site ID and LTS ports associated to csportd interfaces (ASOS or uART). The csportd interface for the fax does not need to be specified here.

4. Configure /usr/local/src/csportd/devices.txt file.

Example:

```
faxmodem suamodem1 suamodem2
```

**Note:** The pseudo devices listed in this file need to match up with the ltserv ports in the /ldad/data/csportd\_control file.

After updating the csportd config files, the LDAD processes will need to be restarted, as well:

```
su - ldad
stopLDADexternal.sh
exit
```

as user **root**,

```
/etc/ha.d/resource.d/csportd start
su - ldad
startLDADexternal.csh
```

**Appendix M**  
**Acceptable Formats for Importing**  
**Climate Data**

## Appendix M. Acceptable Formats for Importing Climate Data

### Table of Contents

	<i>Page</i>
M.1 Data Formats Accepted.....	1
M.2 General Format .....	1
M.3 Contents of File.....	2
M.3.1 Daily Data .....	2
M.3.2 Station Data.....	2
M.3.3 Monthly Data .....	4

### List of Exhibits

Exhibit M.2-1. Example 1: Acceptable General Format for Climate Data.....	1
Exhibit M.2-2. Example 2: Acceptable General Format for Climate Data.....	1
Exhibit M.3.1-1. Example of Bad Format for Daily Climate Data.....	2
Exhibit M.3.1-2. Climate Error Message for Invalid Data .....	2
Exhibit M.3.2-1. Example 1: Acceptable Format for Multiple Station Names .....	3
Exhibit M.3.2-2. Example 2: Acceptable Format for Multiple Station Names .....	3
Exhibit M.3.2-3. Example of Acceptable Format for Single Station Name .....	3
Exhibit M.3.3-1. Examples of Acceptable Format for Single and Multiple Months of Data.....	4
Exhibit M.3.3-2. Example of Acceptable Format for Multiple Months of Data in MM/DD Format .....	5
Exhibit M.3.3-3. Acceptable Format for Single Month Data .....	5
Exhibit M.3.3-4. Acceptable Month First Format .....	5
Exhibit M.3.3-5. Various Acceptable Month First Combinations.....	6
Exhibit M.3.3-6. Various Acceptable Day First Combinations .....	6

### ***M.1 Data Formats Accepted***

When importing existing climatology data files into the Daily Normals, Means, and Extremes database, it is important to know the format of the import file(s). **Climate** will only recognize the limited variety of file formats that are specified below. If the format for the import file is not listed, the **Import Climate** routine will not execute properly.

### ***M.2 General Format***

#### **Headers**

The data file can contain any number of text headers or text lines within the body of the data. Headers between sections of the data are acceptable as well.

#### **Columns and Rows**

The data portion must be arranged in columnar format with one record per row. A record refers to a row of meteorological variables along with a corresponding date. The date can appear anywhere within the row, and rows can continue as long as needed. Exhibits M.2-1 and M.2-2 display acceptable formats.

<b>Date</b>	<b>nh</b>	<b>nl</b>	<b>rh</b>	<b>rl</b>
01	63	45	78	12
02	63	45	83	14
03	62	44	80	10
04	62	44	79	21

**Exhibit M.2-1. Example 1: Acceptable General Format for Climate Data**

or

<b>rh</b>	<b>rhd</b>	<b>rl</b>	<b>rld</b>	<b>pcp</b>	<b>date</b>
78	1979	12	1933	0.14	01
83	1883	14	1965	0.14	02
80	1982	10	1967	0.14	03
79	1945	21	1993	0.14	04

**Exhibit M.2-2. Example 2: Acceptable General Format for Climate Data**

#### **Delimiters**

Delimiters within the data rows can be any symbol except dashes (-), periods (.), or tabs. The program assumes three default delimiters: spaces, asterisks (\*), and slashes (/). Any other delimiters must be entered by the user.

### M.3 Contents of File

#### M.3.1 Daily Data

The data file should contain only daily data or only monthly data. In a case where a file contains both, the program is still capable of importing the type of data (daily or monthly) that the user has specified. When it reaches a line that does not match the format, an error is generated. Exhibit M.3.1-1 is an example of a day and month data within the same file.

day	rec max	rec min	avg pre	rec pre
30	79	42	0.24	1.36
31	81	38	0.25	1.15
<b>Monthly Totals</b>				
<b>Avg Max</b>		<b>Avg Min</b>		<b>Avg Precip</b>
70.6		49.8		3.29

Exhibit M.3.1-1. Example of Bad Format for Daily Climate Data

Exhibit M.3.1-2 shows the error message window resulting from the file above that contains both daily and monthly data. If the user chooses “daily” for data type, the file properly reads data for Days 30 and 31 and the data are stored in the database. The error message is a result of having both the day and month data in the file.

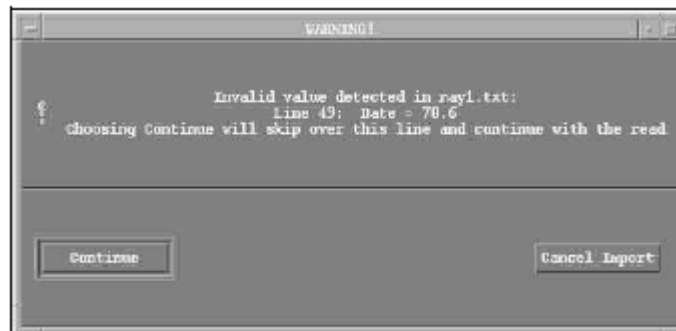

Exhibit M.3.1-2. Climate Error Message for Invalid Data

The program recognizes that the particular data in the file is not as specified and warns the forecaster of the discovery. Choosing **Continue** at this point simply allows the reading of this file to continue (if lines remain to be read). **Cancel Import** breaks the read of this file and continues to the next file in the import list, if other files exist.

#### M.3.2 Station Data

The data file may contain data for any number of stations contained in the station list. All stations in the data file must be in the station database.

## Multiple Stations

If there is more than one station in the file, the station names or their four-letter ICAO IDs must either appear in the text headers separating each station's data or within the data rows themselves. Exhibits M.3.2-1 and M.3.2-2 display acceptable formats regarding the station names.

<b>PITTSBURGH</b>	<b>Data</b>			
<b>January</b>				
<b>date</b>	<b>nh</b>	<b>nl</b>	<b>rh</b>	<b>rl</b>
30	35	26	63	-3
31	35	26	71	-7
<b>Charleston</b>				
30	36	27	72	-10
31	36	37	75	-8

**Exhibit M.3.2-1. Example 1: Acceptable Format for Multiple Station Names**

or

<b>January</b>				
<b>station</b>	<b>nh</b>	<b>hl</b>	<b>rh</b>	<b>rl</b>
Pittsburgh	35	26	63	-3
Pittsburgh	35	26	71	-7
Charleston	36	27	72	-10
Charleston	36	27	75	-8

**Exhibit M.3.2-2. Example 2: Acceptable Format for Multiple Station Names**

If the data file is comparable to Exhibit M.3.2-1, the user should choose Pittsburgh and Charleston in the station list, and the **Station Name(s) in Header(s) box** is automatically selected.

If the data file is comparable to the Exhibit M.3.2-2, the user should select the **Station Name(s) in Data box**.

## Single Station

If a file contains data for one station only, the station name does not necessarily have to appear anywhere within the file.

In Exhibit M.3.2-3, the data will be saved for the station for 29 January and 30 January.

<b>JAN</b>				
<b>date</b>	<b>nh</b>	<b>nl</b>	<b>rh</b>	<b>rl</b>
29	35	26	59	0
30	35	26	63	-3

**Exhibit M.3.2-3. Example of Acceptable Format for Single Station Name**

## General

If **Station Name(s) in Header(s)** is selected, either the complete station name (in all capital letters) or the four-letter ICAO station ID **must** appear in the header(s).

Difficulties reading the station name might occur when the station name is abbreviated in the station list, the station ID contains more than one word, or more than one station exists for a city. If these difficulties arise, the forecaster should edit the data file by adding the station name (in all capital letters) or the four-letter ICAO ID to the header. Examples are:

Pittsburgh    **or**    KPIT  
 Charleston    **or**    KCRW

If **Station Name(s) in Data** is selected, either the complete station name (in all capital letters) or the four-letter ICAO station ID **must** appear in the data. In addition, when arranging the columnar order of the data in the **Import Daily or Monthly Climatological Data** GUI, station name must be chosen or the data will not be saved into the database.

### M.3.3 Monthly Data

The data file can contain data for any number of months.

#### Multiple Months

If there is more than one month in the file, the months must appear either in the text headers separating the monthly data blocks or within the data rows themselves.

If the data file is comparable in format to Exhibit M.3.3-1, the user should choose January and February from the month list, and the **Month located in header(s)** button is automatically chosen.

<b>JAN</b>				
<b>Date</b>	<b>nh</b>	<b>nl</b>	<b>rh</b>	<b>rl</b>
30	39	28	61	-4
31	39	28	58	-10
<b>FEB</b>				
27	43	30	72	0
28	43	31	68	-1

**Exhibit M.3.3-1. Examples of Acceptable Format for Single and Multiple Months of Data**

If the data file is comparable in format to Exhibit M.3.3-2, the user should select the **Month located in Date Field** button and choose the **Month/Day format** in the file. See below for a further description on these options.



Date	nh	nl	rh	rl
01/30	39	28	61	-4
01/31	39	28	58	-10
02/27	43	30	72	0
02/28	43	31	68	-1

**Exhibit M.3.3-2. Example of Acceptable Format for Multiple Months of Data in MM/DD Format**

If a file contains a single month of data, the user should choose the month from the list. If the month appears within the data, the user must select the **Month Located in Data Field** box and choose the appropriate **Month/Day format**.

The forecaster chooses a single month from month list if the following file format in Exhibit M.3.3-3 is comparable to the import file.

Date	nh	nl	rh	rl
01	35	26	59	0
02	35	26	63	-3
03	35	26	71	-7

**Exhibit M.3.3-3. Acceptable Format for Single Month Data**

The forecaster chooses **Month Located in Date Field** and **Month First** format if the following file format in Exhibit M.3.3-4 is comparable to the import file.

Date	nh	nl	rh	rl
Jan/01	35	26	59	0
Jan/02	35	26	63	-3
Jan/03	35	26	71	-7

**Exhibit M.3.3-4. Acceptable Month First Format**

If **Month Name(s) in Header(s)** is selected, at least the first three characters of the month (in CAPS) must appear in the text. The following month names are acceptable:

JAN	FEB	MAY
JANUARY	FEBRUARY	MAY

If **Month Located in Date Field** is selected, there are several acceptable date formats. Single-digit months or days are not dependent on a preceding zero. The month and day may be in two separate, successive fields (separated by one of the defined delimiters). When arranging the order of the data for a file with the date in two separate fields, choose date once in the column order list.

- **Month First** option. The month appears before day in date file. Exhibit M.3.3-5 displays the acceptable combinations for month first options.

Mar-23	03/23	MAR 23
MAR-23	3/23	mar 23
mar-23	03 23	MAR/23
03-23	3 23	mar/23
3-23	Mar 23	Mar/23

**Exhibit M.3.3-5. Various Acceptable  
Month First Combinations**

- **Day First** option. The day appears before month in data file. Exhibit M.3.3-6 displays the acceptable combinations for day first options.

23-Mar	23/03	23 MAR
23-MAR	23/3	23 mar
23-mar	23 03	23/MAR
23-03	23 3	23/Mar
23-3	23 Mar	23/mar

**Exhibit M.3.3-6. Various Acceptable  
Day First Combinations**

- **Julian Days.** Starting at the beginning of the year, days are numbered numerically (1–365). In this case 29 February either is not counted at all or is equal to 366.
- **Julian Days (Feb29=60).** Starting at the beginning of the year, days are numbered numerically (1–366). In this case 29 February is assigned day 60.

**NOTE:** In either Julian Days option, 29 February is not stored to the database.

**Appendix N**  
**AWIPS National Datasets**

As of December 22, 2015, the "National Datasets" (NDM) were removed from baseline so configuration updates could occur as often as needed. So this appendix will be removed in the next release.

**Appendix O**  
**NWRWAVES User's Manual**  
**& Documentation**

The *NWR WAVES User's Manual & Documentation*, a publication of the National Weather Service, has been reproduced in its entirety in this appendix of the SMM. This version of the manual was released in November 2015 and is the current version as of the publication date of the OB16.2.2 SMM.

# NWRWAVES

## (NOAA Weather Radio With All-Hazards VTEC Enhanced Software)

### User's Manual & Documentation

#### TABLE OF CONTENTS

1. SOFTWARE SPECIFICS.....	- 2 -
2. INTRODUCTION.....	- 2 -
3. INSTALLATION OF NWRWAVES.....	- 3 -
4. NWRWAVES SETUP UTILITY .....	- 3 -
Tab 1 – Transmitter Configuration .....	- 6 -
SPECIAL NOTE ABOUT ROUTINE VS. NON-ROUTINE BSA'S .....	- 8 -
SPECIAL NOTE ABOUT CORE COUNTY/CORE ZONE LOGIC .....	- 10 -
Tab 2 – Product Configuration .....	- 11 -
SPECIAL NOTES ABOUT VTEC & SHORT-FUSE WATCHES/WARNINGS .....	- 12 -
SPECIAL NOTES FOR SITES WITH MARINE RESPONSIBILITIES .....	- 12 -
SPECIAL NOTES ON CONVECTIVE WATCH PRODUCT PREPARATION.....	- 22 -
SPECIAL NOTES ON NON-WEATHER EMERGENCY MESSAGES (NWEM) .....	- 22 -
Tab 3 – Summary Message/Miscellaneous Settings Configuration .....	- 23 -
Tab 4 – Marine/Tropical Product Configuration .....	- 26 -
<i>Marine VTEC Processing</i> .....	- 28 -
<i>Hurricane Local Statement</i> .....	- 28 -
<i>Tropical Cyclone Product (TCP)</i> .....	- 28 -
<i>Great Lakes Forecasts</i> .....	- 29 -
5. SETTING AWIPS TEXT DATABASE TRIGGERS.....	- 29 -
SPECIAL NOTES REGARDING TEXT DATABASE TRIGGERS.....	- 31 -
NWEM messages: .....	- 31 -
Convective watches:.....	- 31 -
Selectively specify transmission status based on issuing WFO in OB9: .....	- 34 -
6. NWRWAVES AND YOUR CRS DATABASE.....	- 35 -
TRANSMITTER SPECIFIC MESSAGE TYPES.....	- 35 -
GENERIC MESSAGE TYPES .....	- 36 -
SETTING UP MESSAGE TYPES IN YOUR CRS DATABASE .....	- 37 -
SETTING UP TRANSMITTER SPECIFIC MESSAGE TYPES.....	- 38 -
SETTING UP GENERIC MESSAGE TYPES .....	- 39 -
IMPORTANT NOTES ABOUT CRS MESSAGE TYPES AND YOUR CRS DATABASE .....	- 41 -
7. NWRWAVES OPERATIONS.....	- 42 -
NWRWAVES BROWSER.....	- 42 -
8. NWRWAVES PROGRAM EXECUTION (LOGGING, TROUBLESHOOTING) .....	- 47 -
9. WORD/PHRASE REPLACEMENT CAPABILITY .....	- 50 -
10. SWAPS Capability .....	- 51 -
11. OPTIONS TO PARSE CALL-TO-ACTION IN NWS ALERT MESSAGES .....	- 51 -
12. LESSONS LEARNED AND RESOURCES AVAILABLE .....	- 53 -
APPENDIX A – COMPLETE NWRWAVES FILE LISTING .....	- 55 -
APPENDIX B – EXAMPLE OF EAX siteTrigger.template FILE FOR NWRWAVES.....	- 57 -
APPENDIX C – NWRWAVES Cron Jobs .....	- 59 -
APPENDIX D – Instructions for implementing MWW Watch/Warnings/Advisories .....	- 60 -

APPENDIX E – A List of Product Identifier in OB9 with the new Instruction (CTA) Markers ..... - 64 -  
 APPENDIX F – New features to support HLS & TCV products and operations ..... - 64 -  
 APPENDIX G – NWRWAVES NWEM Processing ..... - 69 -  
 APPENDIX H – Add/Delete/Update Text Database Triggers from AWIPS II ..... - 73 -  
 APPENDIX I – Setting up Red Banner Alert for error messages in AWIPS II ..... - 74 -  
 APPENDIX J –A new RiverPro functionality for Integrate Hazard Information Services in NWRWAVES for  
 flood (point-specific) products..... - 75 -

## 1. SOFTWARE SPECIFICS

<b>Version</b>	AWIPS II
<b>Programming Language</b>	Tcl/Tk
<b>Design Team</b>	Evan Bookbinder – WFO Pittsburg, PA Brian Walawender – Central Region Headquarters Kansas City, MO Michael Hudson – Central Region Headquarters Kansas City, MO Peter Browning – Central Region Headquarters Kansas City, MO
<b>Maintenance Lead*</b>	Warrick Moran – NWR Headquarter Silver Spring, MD
<b>Maintenance Support*</b>	Nancy Helderman – NWR Headquarter Silver Spring, MD
<b>Maintenance Staff*</b>	NWRWAVES: Sung Vo (301) 427-9666 and Peter Wu (301) 427-9659

\*The maintenance support of NWRWAVES has been transitioned to the AWIPS ASM Team.

**Maintenance Lead** Matt Howard ASM/GFE Raytheon/NTTData (301) 741-7299

## 2. INTRODUCTION

NWRWAVES is a comprehensive formatter for NOAA Weather Radio (NWR) products. Its purpose is three fold. First, it is designed to replace all existing formatter capabilities found in the AWIPS WWA program and also the capabilities found in CAFÉ. Second, NWRWAVES utilizes VTEC coding found in an increasing suite of NWS products to better identify, produce and manage outbound CRS Weather Messages. The use of the Message Reference Descriptor (MRD) number will allow sites to better automate their CRS Broadcast Cycle management. Third, NWRWAVES is designed for better sustainability over the numerous scripts used in the CAFÉ approach.

As a new site preparing to use NWRWAVES, there are three basic steps necessary to configure the software for your local area after installation (**Section 2 – INSTALLATION OF NWRWAVES**).

A) The first is to configure your local settings in NWRWAVES. These include your transmitters or broadcast programs, the products that can be processed through NWRWAVES, summary message settings and marine/tropical product settings. NWRWAVES has powerful local configuration tools for product-by-product settings, adding local Listening Area Codes (LACs) and local products, and a customizable word/phrase replacement capability (similar to CAFÉ). Instructions on how to configure these settings can be found in **Section 3 – NWRWAVES SETUP UTILITY**.

B) The second step is to establish triggers from the AWIPS database, which will send products through NWRWAVES. NWRWAVES does feature a test mode, allowing the formatter program to run in conjunction with existing CAFÉ formatters in order to facilitate side-by-side comparisons of output prior to formal activation



(by product) of NWRWAVES. Instructions on how to establish AWIPS text database triggers are located in **Section 4 – SETTING AWIPS TEXT DATABASE TRIGGERS.**

C) The third step (and a necessary one before you transition NWRWAVES to operational mode) is to ensure that your CRS database is structured to accept inbound Weather Messages from NWRWAVES. NWRWAVES uses an approach where each transmitter/broadcast program receives a unique Message Type naming scheme. An explanation of how NWRWAVES generates Weather Messages, along with suggestions on an approach to the structure of the local CRS database, is located in **Section 5 – NWRWAVES AND YOUR CRS DATABASE.**

### **3. INSTALLATION OF NWRWAVES**

If your site has never installed and configured NWRWAVES prior to the installation of OB9, you must first grant permission for users in your office to access the NWRWAVES Setup Utility. This will allow you to configure the software in your office. In the /awips/adapt/NWRWAVES/browser directory, there is a file called “admin.list”. You will need to edit this file and add any AWIPS user accounts that you want to have access to the setup utility. All other users will be blocked.

To edit this file from any AWIPS workstation:

- Open a shell with a user account that has fxalpha group privileges. In this shell, change directories into the NWRWAVES Browser directory:

```
cd /awips/adapt/NWRWAVES/browser
```

- Edit the “admin.list” file:

```
nedit admin.list
```

- Add your local AWIPS user accounts as needed, and delete any existing entries from the default list. Make sure there is only one user account on each line.
- When you are done, save the file and then exit from the editor. Exit from the shell.

You are now ready to run the NWRWAVES setup utility. This utility will allow you to configure NWRWAVES for your local site.

### **4. NWRWAVES SETUP UTILITY**

The next two steps require that you are an AWIPS user whose AWIPS user account is listed in the “admin.list” file as described above.

- A) Open the NWRBrowser on any AWIPS workstation. You will be greeted by the NWRWAVES Browser (Figure 1).

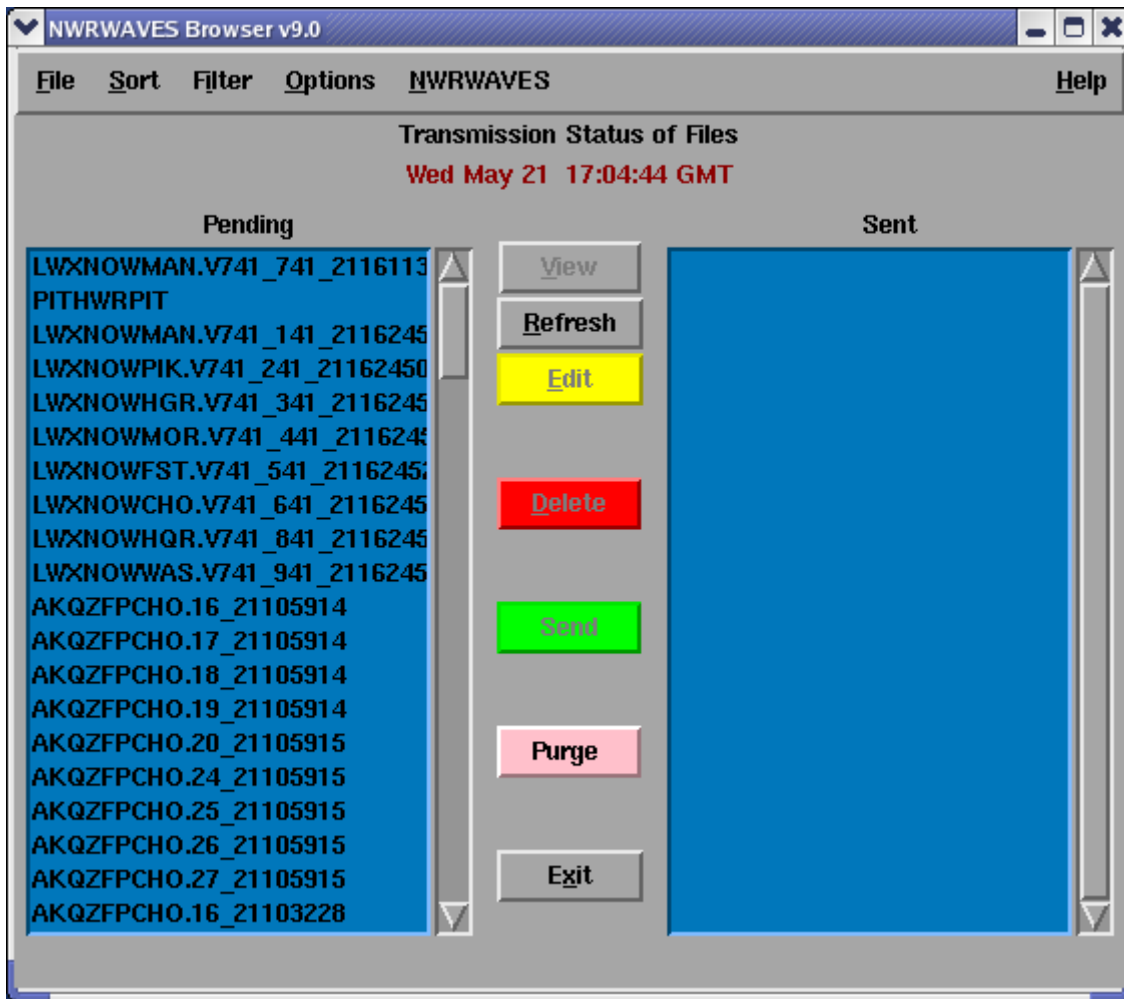

**Figure 1 – NRRWAVES Browser**

The NRRWAVES Browser functionality mirrors that of the NWR Browser, and there are also added capabilities. Details on NRRWAVES Browser operation can be found in **Section 6 – NRRWAVES OPERATION**.

- B) From the “NRRWAVES” pull-down menu, select the option “NRRWAVES Setup”. You will see the NRRWAVES Setup GUI pop-up on your AWIPS screen (Figure 2). The initial display will start on the first of four tabs, which is the transmitter/broadcast program configuration tab

**NOTE:** If you get an error message that a version is already open somewhere else, but you are confident that there is not a version open anywhere on your AWIPS, perform the following steps:

- Open a shell on any AWIPS workstation as a user with ‘fxalpha’ group privileges.
- Type **cd /awips/adapt/NRRWAVES**
- Type **rm -f setup.lock**
- Exit from the shell



**Figure 2 – NRRWAVES Setup GUI**

There are four tabs on the NRRWAVES Setup GUI. Each one governs a unique section of NRRWAVES configuration. You can cycle to each one by simply clicking on the tab label located at the top of the interface. There is a pull-down menu, “File”, which will allow you to ‘Save and Exit’ or simply ‘EXIT WITHOUT SAVING’ the program. The “Help” pull-down menu contains information on the product version.

On each tab, there are buttons labeled with question marks. Each of these buttons contains information on what you need to do for that particular configuration item. Be sure to make liberal use of these question boxes for hints and help.

**NOTE:** When you make adjustments to NWRWAVES configuration data, the current version of your configuration files are saved off into the /awips/adapt/NWRWAVES/BACKUP directory. Details on these file names are in the different ‘Tab’ sections below. When they are saved off into the /BACKUP directory, the naming scheme used is the file name, followed by a date/time stamp. This will allow you to quickly restore from any mistakes made in configuring different components of NWRWAVES.

To configure NWRWAVES, you will work from left to right on these tabs to establish your office configuration. The first tab is our first tab – establishing your transmitter information.

## Tab 1 – Transmitter Configuration

To configure your transmitter (broadcast program) information, complete the following steps:

- 1) At the top of the interface there is a box for you to enter the number of transmitters (number of broadcast programs) you have in your office. Left click in this box, enter in the number of transmitters in your CWA and press the “Enter” key. NWRWAVES will create a list of transmitters (over several rows) for your use. By default, the names of these transmitters will be a default ID of *NWx* (where x is 1 to the number of transmitters). For transmitters over 10, the naming scheme is *Nxx*.
- 2) Select a transmitter by clicking on the radio button by its label “**NWx**” with the left mouse button. For the first transmitter, this will be the one labeled “NW1”.
- 3) Click the “**Change Transmitter Name**” button to set a 3-letter ID for that transmitter. NOTE: the 3-letter ID will be used to create the PIL when generating CRS messages (a transmitter called MCI would produce products like STLNOWMCI, STLSVAMCI, etc). The first three letters of the CRS message is your legacy state AFOS identifier. **NOTE: Be sure to make note of the three letter mnemonic used for each transmitter. This will be important as the naming scheme must match how your CRS database is configured** (see **Section 5** for information on CRS Database configuration).
- 4) If you desire to assign a preamble phrase for your transmitter, enter in a preamble for that transmitter (if desired) in the appropriate box. **NOTE: Clicking on the “?” button located past the “Preamble For XXX” data entry box provides a good example of preamble text.**
- 5) Repeat steps 2 through 4 for each transmitter. Each transmitter must have a unique three letter mnemonic, and this three letter mnemonic will be used for the creation of unique Weather Messages for each transmitter. The preamble phrase is strictly optional.

The next step is to create the list of counties (parishes)/independent cities, and public zones/marine zones/fire weather zones which represent the service area for each transmitter.

- 6) Click on the radio button representing the first transmitter. Left-click in the box to the right of the label “Selected WFO/Center Site ID”. Your office ID should default as the entry for this box. If it is missing for any reason, enter in your office’s three letter identifier into this box, then hit the ‘Enter’ key.
- 7) You will see a list of county/parish/independent cities appear in the left hand column. There are two radio buttons next to the box you entered your site ID into in (6) above. The default radio button set is “**Select Counties/Independent Cities for XXX**”, where “XXX” is your site ID. You will assign county (FIPS)

codes and zone (Z) codes separately for each transmitter. This will allow maximum flexibility for unique circumstances in managing your service area.

- 8) The list of county (parish)/independent cities and zones is kept in a default distribution file in the /awips/adapt/NWRWAVES/bin directory and is called "UGClookup.table". This file was derived from AWIPS shape files and is as complete as possible. **Sites will not modify the UGClookup.table file!** If you note errors in the names of your counties (parishes) or zones, please post them to the NWRWAVES listserver, so they can be fixed. This file is now (from OB9.2) part of the National Datasets Maintenance (NDM) files on NOAA1 baseline file. See the following URL for details (close to the bottom): <http://www.weather.gov/ndm/>. Sites with marine zones may want to pay close attention, as some of the marine zone names are somewhat verbose in the default file.

Your transmitter configuration tab will initialize with your WFO identifier's list of counties (parishes)/zones.

There may be instances where a county/zone is missing, or where your office uses a local "dummy" county or zone code on your transmitters. You can add any missing or custom listening area Codes (LAC's) into NWRWAVES. Likewise, you can also edit or delete any existing local LAC's. To do this:

- a) Click on the pink button labeled, "Edit Local LAC".
- b) A pop-up GUI will appear, and you will be prompted to enter data into it (Figure 2a).

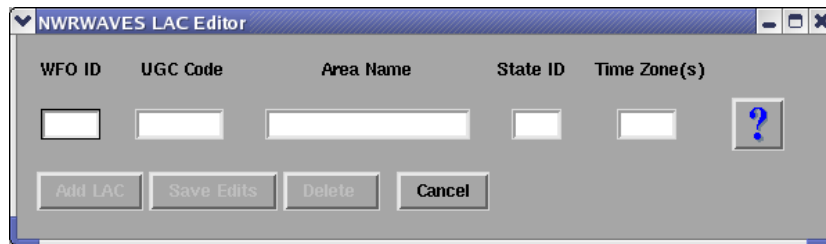

**Figure 2a – Add a local listening area code (LAC)**

- c) From left to right, enter the associated WFO (likely yours), the six-character UGC code (i.e., MOC998, KSZ999), the name of your new LAC (i.e., Generic County), a two-letter state ID (i.e., KS) and the time zone of this new LAC. **Note that in the Help Message of this LAC Editor, the word "MARINE" is suggested to be used to specify a marine zone. This feature is now available in version OB9.**

For the time zone, the primary option is a capital letter for the appropriate time zone (**E**-Eastern, **C**-Central, **M**-Mountain, **P**-Pacific, **A**-Alaskan, **H**-Hawaiian, **g**-Guam, **a**-Virgin Islands/Atlantic Time). If an LAC doesn't observe Daylight Savings Time, use a lower case letter from the ones listed above in lieu of the capital letter. For example, an entry of "**c**" represents that this LAC observes Central Time and does not observe Daylight Time.

If an LAC is large enough to encompass two time zones, the use of a two-letter code is appropriate. For example, "**eC**" would be used for an LAC that covers part of the Eastern Time zone that doesn't observe DST, but also one that covers part of an area in the Central Time zone that does observe DST).

If you enter the same data as an existing local LAC, you will see the buttons for ‘**Save Edits**’ and ‘**Delete**’ become usable. If the data is new, you will only be given the option to ‘**Add LAC**’.

- d) Click the appropriate button for the action needed when you have finished entering in your local LAC.

Repeat step 8 as necessary to add all local FIPS and zone codes for this transmitter. Any local LAC’s will be added into the /awips/adapt/NWRWAVES/bin directory in the file “localUGClookup.table”.

- 9) To select counties (zones) for inclusion in a transmitter’s service area, left-click on any applicable county names in the left blue list box. This list will include all baseline counties (zones) as well as any local entries you have entered. You can select multiple counties all at once simply by clicking on the county names (there is no need to hold the “SHIFT” or “CTRL” buttons to multi-select counties). Once you have them selected, you can assign them to either the Routine Broadcast Service Area (BSA) or the Non-Routine Broadcast Service Area (NBSA) by clicking the appropriate → button. Likewise, you can remove counties back to the master list by highlighting them in the right blue list boxes and clicking the ← button.

### **SPECIAL NOTE ABOUT ROUTINE VS. NON-ROUTINE BSA’S**

Each transmitter has a separate list for Routine Counties/Zones and Non-Routine Counties/Zones. In the context of NWRWAVES, this is **not** necessarily a one-to-one relationship with the routine service area of your CRS transmitters. Establish your lists by using any county/zone for which you routinely broadcast information (tone alerts for warnings, etc.) in your Routine BSA. Users would then include county/zone entries that reside outside a normal reception area in the Non-Routine BSA. This is useful as you can include counties in your Non-Routine BSA for which you do unique tone-alert settings by product, counties that are out of your transmitter’s coverage area but for which you carry WRSAME bursts for an area radio station, or to set a county from a distant office to carry a product such as an HLS (where you are an inland office but wish to broadcast information about a land falling tropical system from a nearby coast).

Once you have selected all the counties within your CWA, you can select county/counties from other CWA’s if your transmitter overlaps another office’s CWA. To do this, go back to step (6), and change the office ID from yours to the other office, then hit “ENTER”. **NOTE:** to access counties (parishes)/zones from another office, type that office’s 3-letter ID into the box next to the label “Select WFO/Center Site ID” to populate that office’s list. To enable a list of off-shore marine zones, type “OPC” into this box to access the off-shore zones that the Ocean Prediction Center uses for the OFF products.

- 10) Repeat steps 7, 8 and 9 for counties from that office. Repeat step (10) for all offices that affect the service area of this transmitter.
- 11) **CORE COUNTY SETTINGS (NEW):** Once you have established your set of routine/non-routine counties (parishes/independent cities), you may assign one of these to the transmitter’s core county. To do this, **right click on the label** of one of your counties/parishes/independent cities (in either the Routine or Non-Routine BSA lists), and you will see its appropriate LAC code listing appear in the box above labeled “Core County”. This is your core county for this transmitter.

- 12) Once you have assigned the county (parish)/independent cities for this transmitter, click on the radio button labeled “[Select Zones for XXX](#)”. This will allow you to assign the “Z” or zone codes for this transmitter.
- 13) Repeat steps (6) through (10) to select all zones applicable to this transmitter. The zone listings are inclusive to all forecast, marine and fire weather zones.
- 14) **CORE ZONE SETTINGS (NEW)**: Once you have established your set of routine/non-routine zones, you may assign one of these as the transmitter’s core zone. To do this, **right click on the label** of one of your selected zones (Routine or Non-Routine), and you will see the appropriate LAC code listing appear in the box labeled “Core Zone”. This is your core zone for this transmitter.
- 15) Click the green “Save Transmitter Edits” button to save off the configuration data for this transmitter.
- 16) Left-click on the radio button for the next transmitter in your configuration list.
- 17) Repeat steps (6) through (15) for each transmitter.

Once you complete these steps, you will have selected county (parish)/independent cities and zones listings for all of your transmitters. Each transmitter will have a unique three-letter mnemonic, and (if applicable), you will have assigned each transmitter with an optional preamble phrase **and an optional core county (parish)/independent city and core zone**.

The transmitter configuration settings are stored in the /awips/adapt/NWRWAVES directory in the file “**transmitter\_cfg.XXX**”, where ‘XXX’ is your AWIPS site identifier. **You should not hand-edit this file!** Any changes required must be made through the NWRWAVES Setup GUI.

Once you have configured the transmitters, your “Transmitter Configuration” tab should look similar in format to Figure (3). The next step is to configure products for processing through NWRWAVES.



**Figure 3 – an example of a complete Transmitter Configuration tab**

**SPECIAL NOTE ABOUT CORE COUNTY/CORE ZONE LOGIC**

Sites have the ability to assign a core county and/or a core zone to each of their individual transmitters. The logic behind a “core county/core zone” is that for certain products, only the segment which contains this core LAC will be processed and sent to that transmitter. Furthermore, only the core LAC will be used in message assembly; therefore, Identical Message Type/Identical LAC replace will occur dependably. Most sites will use core county/core zone for legacy products such as the ZFP, NOW, HWO, etc. **Use of the core county/core zone is not appropriate for watch/warning products.**

The core county and core zone are global by transmitter. In other words, you only have one of each for every unique transmitter. You do not have the ability to use one ‘core zone’ for the ZFP, and a second for the NOW. If you followed instructions in v2.4 to assign counties/zones to the Routine vs. Non-Routine BSA’s to replicate a core county/zone functionality, you should reassign these lists to take advantage of process/no process and unique tone alert capabilities.



## Tab 2 – Product Configuration

After you are done configuring your transmitters, click the **Product Configuration** tab (Figure 4)

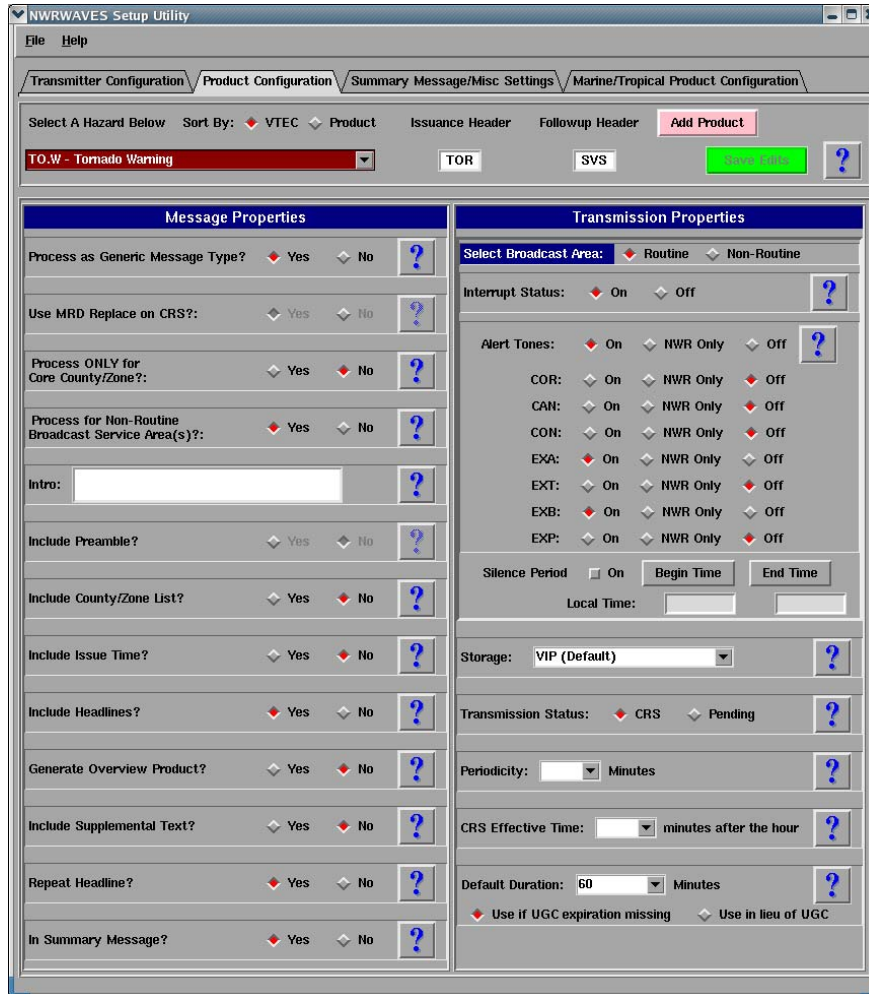

**Figure 4 – Product configuration GUI**

This tab is used to set all the configuration items for each NRRWAVES product type. Those used to WWA or CAFÉ formatters should note some similarities, but many new features will also allow for extensive customization of CRS messages.

In the top left corner you will see a red pull-down menu which contains a list of all of the baseline product types that can be formatted to CRS using this software. The list is arranged alphabetically by a leading three letter identifier. Some of these products have a period in them (i.e., **SV.W**) which indicates a VTEC product code. Others do not (i.e., **LEW**) which indicate a non-VTEC product.

VTEC products listed do not at times correspond directly to their AWIPS product identifier (i.e., HS.W is issued in AWIPS as a WSW). *When you think about products and configuring them for NRRWAVES, think of them in terms of their VTEC code and not their AWIPS product identifier.* There are legacy AWIPS product identifiers in

the product configuration list (i.e., **SV.W** is there for a Severe Thunderstorm Warning, and **SVR** is also listed as a Severe Thunderstorm Warning). NWRWAVES will use the VTEC phenomena and significance codes as its primary lookup, so the entry for SVR is redundant and only used if for any reason the VTEC line was somehow corrupt or missing from a Severe Thunderstorm Warning.

Both product types (VTEC and non-VTEC) share many common configuration settings. VTEC products have additional unique configuration settings for alert tone settings, based on the VTEC action code. VTEC products are also tracked internally by NWRWAVES, and the advanced feature of MRD Replace is used to facilitate better automation of information replacement in the CRS Broadcast Cycle. **In the NWRWAVES distribution file, all these configuration settings are set to “No” and the product dissemination is set to the “Pending” side of the NWRWAVES Browser (as they are shown in Figure 4 above).** Sites will need to adjust these settings \*by product\* to meet their local needs.

### **SPECIAL NOTES ABOUT VTEC & SHORT-FUSE WATCHES/WARNINGS**

In the VTEC sense, a tornado watch is defined as a TO.A, a severe thunderstorm watch a SV.A, a tornado warning as a TO.W, and a severe thunderstorm warning as an SV.W. When you begin to configure products in NWRWAVES, you must think of these products as their VTEC hazard, and not their AWIPS product. For example, you would configure all options for tornado warnings under the “TO.W” option in the product list in NWRWAVES. If you wish to have the follow-up SVS statement’s headlines read, you will need to turn the “Include Headlines” option to “On” under the “TO.W”. Why? The AWIPS product does come out as an SVS, but it has the “TO.W” VTEC code in it, which is what NWRWAVES will use to determine what to do with the inbound tornado warning follow-up.

There are legacy AWIPS product identifiers in the NWRWAVES product list (e.g. TOR, SVR, NPW, etc...), just in case a product is inadvertently sent without VTEC coding. You should also configure these just in case.

VTEC coded short fuse watch and warning products are as follows:

*SV.A – Severe Thunderstorm Watch*

*TO.A – Tornado Watch*

*TO.W – Tornado Warning*

*SV.W – Severe Thunderstorm Warning*

### **SPECIAL NOTES FOR SITES WITH MARINE RESPONSIBILITIES**

Marine products such as the Near Shore Forecast (NSF) and Coastal Waters Forecast (CWF) (and soon by directive to include the Offshore Forecast (OFF) and Great Lakes Forecast (GLF)) have numerous VTEC possibilities. You have the option in NWRWAVES to enable/disable VTEC use for these products (settings are established in Section 3 – Tab 4 below), as VTEC can lead to some complicated processing of segments and messages on the air.

If you decide to have NWRWAVES track VTEC, you will need to configure NWRWAVES for each of these VTEC event and significance codes (each is considered a unique product). You will be able to tone alert (by VTEC phenomenon). You will not be able to set a default under the NWRWAVES product types of NSH and CWF (as appropriate) and see the products process. These VTEC event codes are as follows:

*CF.A – Coastal Flood Watch*

*CF.S – Coastal Flood Statement*

*CF.W – Coastal Flood Warning*  
*CF.Y – Coastal Flood Advisory*  
*GL.W – Gale Warning*  
*HF.W – Hurricane Force Wind Warning*  
*LO.Y – Low Water Advisory*  
*LS.A – Lakeshore Flood Watch*  
*LS.W – Lakeshore Flood Warning*  
*LS.S – Lakeshore Flood Statement*  
*LS.Y – Lakeshore Flood Advisory*  
*MA.F – Routine Marine Forecast*  
*MA.S – Special Marine Statement*  
*MA.W – Special Marine Warning*  
*RB.Y – Small Craft Advisory for Rough Bar*  
*SC.Y – Small Craft Advisory*  
*SE.Y – Hazardous Seas Advisory*  
*SI.Y – Small Craft Advisory for Wind*  
*SR.W – Storm Warning*  
*SU.W – High Surf Warning*  
*SU.Y – High Surf Advisory*  
*SW.Y – Small Craft Advisory for Hazardous Seas*  
*TS.A – Tsunami Watch*  
*TS.W – Tsunami Warning*

If you disable VTEC tracking for these marine products, NWRWAVES will treat them as non-VTEC products, and the settings under the NWRWAVES product types of “NSH” and “CWF” (also “OFF” and “GLF”) will be used universally regardless of the VTEC hazards contained in each segment. You will **not** be able to assign tone alerts by VTEC phenomenon. You would only need to configure these four NWRWAVES product entries (as applicable to your office):

*CWF – Coastal Waters Forecast*  
*NSH – Near Shore Forecast*  
*OFF – Offshore Waters Forecast*  
*GLF – Great Lakes Forecast*

Starting August 2007, many Weather Forecast Offices (WFO)s have started issuing experimental Marine Weather Warning (MWW) bulletins. The MWW is intended to better inform mariners of adverse marine weather hazards and serve as a dedicated long duration marine Watch, Warning and Advisory product. The MWW bulletin will provide the marine community with more specificity and vital marine hazard information, patterned after the winter weather watch/warning/advisory (WSW) bulletin and the non-precipitation watch/warning/advisory (NPW) bulletin. A complete VTECs support listing of MWW and sample instructions for implementing Small Craft Advisory (SC.Y) is included in Appendix D.

To begin modifying product parameters:

- 1) Select a product from the drop down menu. (**NOTE: These items can be arranged alphabetically by VTEC phenomena or by product type by clicking the appropriate radio button**).
- 2) The settings for this particular product are displayed.
- 3) Each configuration item on the GUI has a question mark box to its right. Click on that question mark box to see more information on what that particular item governs. Referencing Figure 4 above, here is a breakdown of the interface:
  - a) Starting to the immediate right of the product drop-down list, there are two boxes labeled “Issuance Header” and “Followup Header”. Assign the CRS product identifier (middle three letters) into these boxes. **These entries can differ from the VTEC phenomena/significance codes or the AWIPS product identifier!** For example, a Severe Thunderstorm Warning has a VTEC phenomena/significance code “SV.W”, an EAS product issuance code of “SVR” and a follow-up code of “SVS”. You want to ensure that the “Issuance Header” and “Followup Header” are consistent with EAS codes (and resultant CRS Weather Messages). You will see this with much of your winter weather, non-precipitation and severe weather product suite.

**NOTE: Where appropriate, the default NWRWAVES distribution file will contain EAS codes for various watch and warning as mandated by directive. Sites should not change the issuance or follow-up headers for warning or watch products without first checking the applicable directives.**

Down the left-hand side of the product configuration interface, you will see yes/no selectable options for the following items labeled “**Message Properties**”:

- b) **Process as Generic Message Type:** This option, if selected “Yes”, instructs NWRWAVES to assemble a single generic message for each VTEC line/product segment versus the default transmitter specific messages. CRS would then sort the generic weather message on the LAC list assigned to that message. Specific details regarding generic message versus transmitter specific message assembly is discussed in **Section 5 – NWRWAVES And Your CRS Database**.
- c) **Use MRD Replace on CRS:** This option is grayed out (not selectable) and set to “Yes” by default for all VTEC coded products. The option is also grayed out (non-selectable) for all non-VTEC products with the exception of those listed for exclusion from this rule in the file `/awips/adapt/NWRWAVES/NONVTECMRD.txt`. If a three letter non-VTEC product is listed in this file, then you can choose the option of using MRD Replace for those non-VTEC products.

The content of the NONVTECMRD.txt file follows the following example:

```
NOW,N
SPS,Y
HWO,N
```

The NOW, SPS and HWO products can be configured by the local site to use non-VTEC product MRD Replace. Only the SPS will use the MRD Replace in the above configuration. The NOW,

SPS and HWO are the only products listed in the baseline distribution of NWRWAVES, due to somewhat unpredictable behavior that can occur in the absence of VTEC.

More information on what MRD replace is, and how it functions within NWRWAVES, can be found in **Section 6 – NWRWAVES OPERATION**.

- d) **Process Only for Core County/Zone:** If “Yes” is selected, NWRWAVES will process only those product segments whose UGC listings contain the core county (parish/independent city) or core zone as established for each transmitter. This option would be effective for products such as the ZFP where an office may only want to broadcast a specific zone segment for each transmitter on NOAA Weather Radio. Core county/zone settings are global per transmitter, so the same core zone would be used on transmitter ‘ABC’ for the NOW as well as the ZFP.
- e) **Process for Non-Routine Broadcast Service Area(s):** If set to “No”, then an inbound product/segment will not be processed if the UGC line contains only non-routine BSA counties/zones for a given transmitter. If set to “Yes”, then the inbound product will be processed if it contains UGC codes found only in the non-routine BSA settings for that transmitter. Any alarm/alert settings used will be governed by the non-routine BSA alert settings (covered later).
- f) **Intro:** An optional text box where you can type in an intro phrase for this product. For example, “NOW HERE IS YOUR SHORT TERM FORECAST” could be used for the “NOW” product. The intro phrase can be used in combination with the transmitter preamble phrase (set in Section 3 above) and also with a county (parish), zone and independent city listing to create lead-ins for your CRS products. **NOTE: you must have an Intro phrase to include the county/zone list in (f) below. Otherwise, you would not get radio-ready text from NWRWAVES for these two sections.**
- g) **Include preamble:** If set to “Yes”, the preamble you defined per transmitter in Section 3 will be used as part of the lead-in for this product. You will want to use this option with the Intro or County/Zone list, as the wording will not turn out very cleanly. An example preamble might read, “In the K I D 77 listening area”.
- h) **Include County/Zone list:** If set to “Yes”, this will return a listing of counties, parishes, independent cities or zones affected on this transmitter by this product. An example phrase might be, “for the following counties, in Missouri, Bates, Jackson and Johnson. This also includes the following Virginia independent cities, Alexandria and Richmond.” **NOTE: This feature will only work if you define in Intro in (d) above.**
- i) **Include Issue Time:** If set to yes, the time the product was run through NWRWAVES will be included. An example phrase would be, “Issued at 3:15 pm CDT”.

If you have options (f) through (i) set to yes in these examples, an intro phrase for the Short Term Forecast (example given in f) might read as follows:

*“HERE IS YOUR SHORT TERM FORECAST, for the following counties In the K I D 77 listening area, in Missouri, Bates, Jackson and Johnson”.*

- j) **Include Headlines:** If set to “Yes”, headlines contained in the inbound product will be formatted correctly and included in the CRS product, otherwise they will be omitted. You will likely want to set this feature to “Yes” for most products that could contain headlines. **NOTE: You may wish to disable headlines for products produced from GHG, as they duplicate the headline in the attribution statement. This will give you two headlines on the air.**
- k) **Include Overview:** If set to “Yes”, NWRWAVES will generate a separate overview product, containing the overview and any overview headlines contained in the product. This outbound message will be generated under the CRS ID -- CCCOVRXXX where CCC is the issuing office, OVR is literal, and XXX is the AWIPS Product ID. For example, if product STLWSWEAX contained an overview and this option is set to YES for any of the VTEC phenomena it contains, NWRWAVES would generate a separate overview product under the CRS ID EAXOVRWSW. Since the OVR is a separate message, offices can configure this product as well by modifying the settings in this section under the “OVR - Overview” product from the pull down list.
- l) **Include Supplemental Text:** Offices can use the “&&” delimiter to separate the main body of text from a supplemental text section in products. If this is set to “Yes”, then the CRS product will include any text below the “&&” and before the “\$\$” that signifies the end of the segment (product). Otherwise, anything below the “&&” will be omitted from the CRS product.
- m) **Repeat Headline:** If set to “Yes”, then the event headline will be repeated at the end of the text captured from the product. If set to “No”, then the hazard headline will not be repeated. This is useful in the case of a Tornado Warning. The resultant text added would read like this example, “Repeating, a tornado warning has been issued for Jackson County, Missouri, effective until 4:45 PM CDT.” **NOTE: This functionality exists only for VTEC encoded products.**
- n) **In Summary Message:** If set to “Yes”, then this particular product (hazard) will be tracked as a summarized hazard, depending on your Summary Message settings that you establish in Tab 3 later. For now, if you wish this hazard to be summarized on your transmitters, set it to “Yes”, otherwise leave it set as “No”.

The right hand side of the GUI interface contains the “Transmission Properties” section of settings (Figure 4a and 4b) for both VTEC and non-VTEC products.

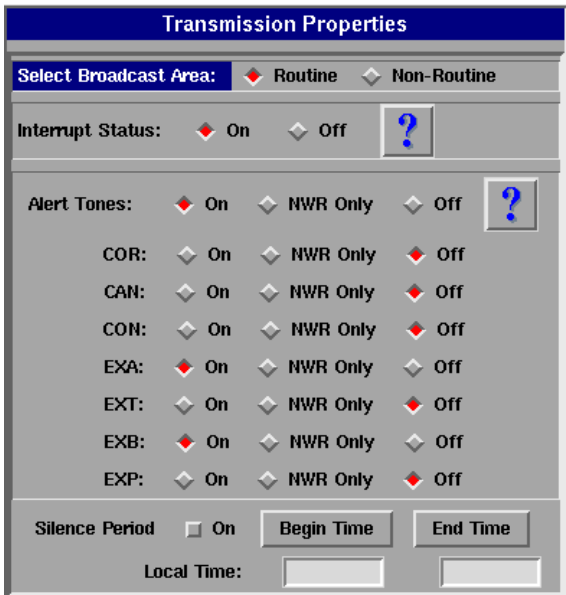

Figure 4a – VTEC transmission properties



Figure 4b – non-VTEC transmission properties

- o) For all products, you can toggle between the settings for your routine BSA and your non-routine BSA listening areas. Click the radio button between the two to switch between them. When you are configuring your non-routine BSA settings, the background of this section will switch from grey to an aqua-blue (Figure 4c on the following page).

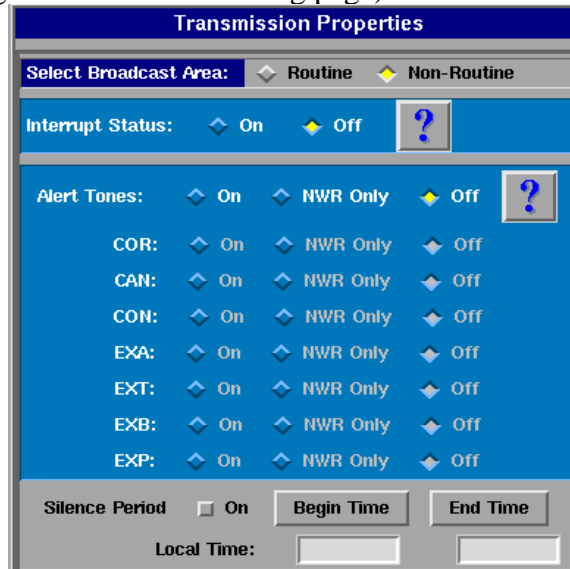

Figure 4c – non-routine BSA color background

- p) For both VTEC and non-VTEC products, you can toggle ‘Interrupt’ status to “On” or “Off”. If set to “On”, all instances of this product that are sent to CRS will interrupt the routine broadcast.

For the ‘Alert Tones’ setting for both product types, you have three options: “On”, “NWR Only” and “Off”. If set to “On”, then the 1050Hz and WRSAME tones will be sent with this product.

**IMPORTANT NOTE: For all short fuse watches and warnings, including Tornado Watches/Warnings, Severe Thunderstorm Watches/Warnings, and Flash Flood Warnings,**

**leave the default settings of “On” for the “Alert Tones” option, and for the VTEC options of “EXA” and “EXB” as shown on the left-hand side of Figure 4a.** By default, for all short-fuse warning products listed in Directive 10-1710, alert tones come in NWRWAVES set to “On” for initial issuance, as well as for extensions in area (EXA), and extensions in both area and time (EXB).

The “Off” setting will generate no tones at all.

The “NWR Only” setting will allow you to use your CRS Message Type settings to govern whether to include just the SAME tones and/or the 1050 Hz tone (if defined under unique properties).

**IMPORTANT NOTE: Take special care when using the “NWR Only” option for alert tones. Unless you’ve specifically assigned the 1050 Hz tone \*by transmitter\* under the ‘Transmitter Specific’ blue button on the CRS Message Type GUI, the “NWR Only” option will simply check for any SAME settings in your Message Type to use. If you haven’t done anything special to assign the 1050 Hz tone by product, you can think of the “NWR Only” option as a ‘SAME-only (if configured)’ option.**

For the VTEC coded product, this setting only governs the “NEW” action code within the VTEC line. You can then set alert tones settings for additional VTEC action codes shown on the GUI interface. These can be quite powerful in configuring alert tones for your warning suite. For example, a “TO.W” Tornado Warning product would have the “Alert Tones” set to “On” for initial issuance. As follow-up SVS products are issued, you could set the “CON” action code to “NWR Only” (and your SVS Message Type set to WRSAME only in your CRS database) to send only SAME tones for follow-up SVS statements that continue the Tornado Warning. Your setting for “EXP” and “CAN” could be set to “No”, so that no tones of any kind are sent for an expired or cancelled warning.

For non-VTEC products, the “Alert Tones” setting governs any issuance of the product (governed by AWIPS product identifier). An example of this is the “FFW” (non-VTEC coded product). While the follow-up product for an FFW is an FFS, “FFS” has its own product identifier listed in the NWRWAVES product database, therefore the alert tone settings of the FFW will not be used for the FFS. When this product becomes VTEC coded, the product identifier “FF.W” in the NWRWAVES product list will then be used, and the alert settings for follow-up statements will be those you assign.

- q) **Silence period:** If this box is checked, you can override the “Alert Tones” settings for specific periods during the day. You set these by clicking on the boxes labeled “Begin Time” and “End Time”. Figure 4d shows the GUI used to set these times.



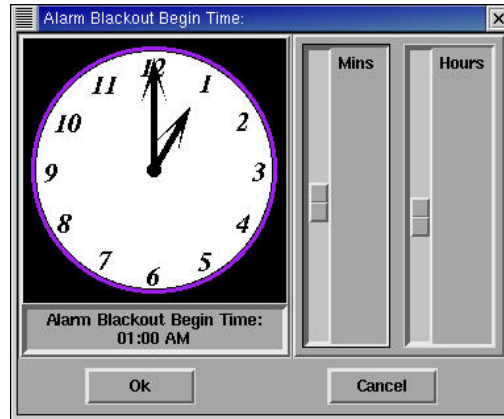

Figure 4d – Silence period time setting

If this **Silence period** box is selected and the silence period is specified, NWRWAVES will send a Red Banner (See Figure 4d.1) when the silence period is ended to alert the forecasters to use the CRS system to resend the product with Alert/Interrupt if required.



Figure 4d.1 – Red Banner when Blackout period has ended

The last section of the “Transmission Settings” GUI sets the disposition, periodicity and disposition of CRS messages (Figure 4e).

The screenshot shows a vertical stack of configuration fields for 'Transmission Settings'. Each field has a question mark icon to its right. The fields are:
 

- Storage:** A pull-down menu currently set to 'VIP (Default)'.
- Transmission Status:** Two radio buttons, 'CRS' (selected) and 'Pending'.
- Periodicity:** A pull-down menu with a blank space next to it, followed by the word 'Minutes'.
- CRS Effective Time:** A pull-down menu with a blank space next to it, followed by the text 'minutes after the hour'.
- Default Duration:** A pull-down menu set to '60', followed by the word 'Minutes'.

 At the bottom of the form, there are two radio buttons: 'Use if UGC expiration missing' (selected) and 'Use in lieu of UGC'.

**Figure 4e – final transmission settings**

- r) **Storage:** From the pull-down menu, you can select from ‘Active’, ‘Inactive’, ‘Synthetic Speech Override’, or ‘VIP (Default)’. By default, every product in the baseline NWRWAVES distribution is set to ‘VIP (Default)’.
- s) **Transmission Status:** If set to ‘CRS’, this product will be sent directly to CRS for airplay. If set to ‘Pending’, the outbound product(s) will be placed in the Pending side of the NWRWAVES Browser. Every product in the NWRWAVES distribution is set to ‘Pending’.

**NOTE:** Sites should leave the disposition of CRS products to ‘Pending’ for every product until they are ready to begin active use of NWRWAVES. At that time, products can be converted from ‘Pending’ to ‘CRS’ one-by-one to ensure a smooth transition.

- t) **Periodicity:** You can type in a number (in minutes) or select a number from the drop-down menu, to assign to this product. If you wish to remove a periodicity setting, you can left-click in the text box next to the triangle, backspace over the number, then left-click in the gray area to reset it to a blank.
- u) **CRS Effective Time:** This setting allows you to establish the minute (00-59) at which you’d like an outbound message to begin broadcast. From an automated standpoint, this feature is best used with the periodicity setting above to establish set times for message broadcasting. For example, setting a product’s effective time to 00 and the periodicity to 15 minutes would cause that message to play with predictability “on the 15’s” (provided the message is not in a Message Group in your Broadcast Suite on CRS).
- v) **Default duration:** You can type in a number (in minutes) or select one from the drop-down menu to set a default duration for any product that is missing a UGC line. If you have a UGC coded product but do not wish to play it for an extended time, you can click the “Use in lieu of UGC” radio button to force the default duration time no matter what the UGC expiration time is in the product.

- w) When all these settings have been configured for this product, click the green “Save Edits” button at the top of the interface.
- 4) Repeat steps 1, 2, and 3a through 3w for every product in the drop down list that your office processes for CRS.
- 5) You may find that a local product issued by your office is missing from the product configuration file, or that a regional/national product is also missing. You can also add products locally to your product configuration file. In the case of the regional/national product in scope, you will want to add it but also post it as a future addition for the baseline to the NWRWAVES list server.

To add a local product to the Product Configuration list:

- a) Click on the pink “Add Product” button found towards the top right of the Product Configuration tab GUI.
- b) A pop-up GUI interface will display (Figure 4f). In the text boxes provided, fill in the basic information of the new product, similar to what is displayed below.

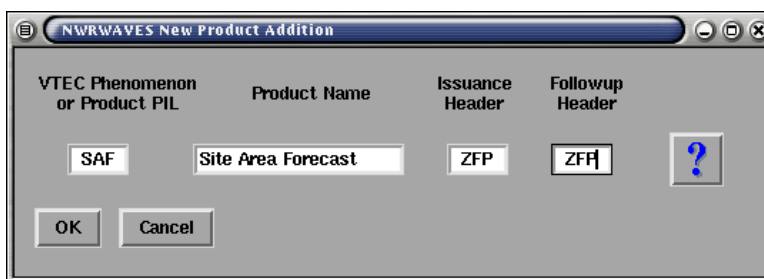

**Figure 4f – Add a new product to NWRWAVES**

- c) If the product is VTEC encoded, be sure to include a period between the second and third letter of the VTEC Phenomenon or Product PIL entry. Otherwise, just enter the three letter identifier of the CRS Product PIL.
- d) Click the ‘OK’ button once these entries are complete.
- e) You will be returned to the Product Configuration Tab GUI. Complete step 3 in its entirety to finish configuration of this new product. When done, click the green “Save Edits” button to save your new product. NWRWAVES will double-check to ask if you really want to save this new product to your product configuration list.

Product configuration data is stored in /awips/adapt/NWRWAVES in the file **product.cfg**. **Sites will not hand-edit this file!** It is comma delineated, and there is a significant risk of messing up critical NWRWAVES configuration data by hand-editing the file. Sites will use the NWRWAVES Setup GUI to make adjustments to product configuration. Your local product.cfg file will be restored every time you upgrade to a newer version of NWRWAVES.

## **SPECIAL NOTES ON CONVECTIVE WATCH PRODUCT PREPARATION**

NWRWAVES functions similarly to CAFÉ with respect to convective watch message generation. CAFÉ would process either the WOU or WCN bulletins, and through the use of VTEC, CAFÉ would then generate an output message customized for NWR internally, using VTEC phenomenon/significance codes and VTEC action codes to govern tone alert settings (CAFÉ WBC4CRS formatter).

For CONUS sites, NWRWAVES begins with the WOU(x) issued by the SPC for all convective watches. The WOU(x) includes all affected land FIPS codes and marine zones (regardless of state and CWA), VTEC, with the VTEC phenomenon and significance codes, the VTEC action code (NEW, CON, CAN, etc.), and an event tracking number. The WOU(x) product makes a perfect vehicle from which to prepare all convective watch bulletins. NWRWAVES will build a watch message from the decoded elements of the WOU (FIPS/marine zone codes, VTEC) through internal code and phrasing. No part of the actual WOU(x) bulletin is included in the outbound CRS Weather Message. WOU update and cancellation products are ignored. **NOTE: For OCONUS sites where the SPC does not issue convective watches, NWRWAVES will use the initial WCN for tone alerting purposes. This setting is governed by your OCONUS global variable sourced from the AWIPS operating environment.**

For both CONUS and OCONUS sites, NWRWAVES will then use any \*followup\* WCNxxx messages to track the status of a convective watch. NWRWAVES will internally create a message/call-to-action for all affected areas, with CRS Weather Message attributes (SVA, TOA) based on the hazard. No part of the actual WCN bulletin is included in the outbound CRS Weather Message.

Alert tones will be sent/not-sent based on the VTEC action code customized by each office under Tab 2 above. By default settings (per directive 10-1710), the only VTEC action codes that would trigger a new tone alerted SV.A/TO.A product from a WCN would be the codes “EXA” and “EXB”, which add new counties to a watch through the WCN.

**NOTE: You will need text database triggers for all WOU statements (WOU0 through WOU9), your local office WCN, and any other surrounding office’s WCN’s that apply to areas covered by your transmitters. Text database triggers are covered in Section 4.**

## **SPECIAL NOTES ON NON-WEATHER EMERGENCY MESSAGES (NWEM)**

NWRWAVES will be fully compatible with the new HazCollect system slated for operational status in 2006. NWRWAVES will replace the NWEM CAFÉ formatter formally in **OB9.2**. In anticipation of this switch in 2007, all the NWEM CRS Weather Messages are included in the default product configuration, with EAS PILS (issuance header and followup header) that are consistent with 10-1710. **OB9.1 or older**, HazCollect is still calling the legacy NWEM CAFÉ formatter. **NOTE: In the pre and post-OB9.2 environment, sites will not establish text database triggers for any NWEM messages! HazCollect calls its NWR formatter internally, so there is no need to duplicate the call in a separate trigger. No action is required prior to OB9.1 to configure NWRWAVES for NWEM messages.**

After installation of OB9.2 NWRWAVES will become the default NWR formatter for NWEM products. This migration will provide logic to place “test products” into the NWRWAVES pending directory and software defect support by the OPS23 CRS Staff. Another enhanced capability of NWRWAVES is that a site can change the

EAS PILS (issuance header and followup header) if state or local broadcaster policy is to not use the new EAS PILS. For example, the Missouri Broadcasters Association has asked the NWS to use the EAS PIL “**CEM**” for all these new hazards until further notice, as many member stations have not upgraded their EAS equipment. All these NWEM hazards can be set to convert their AWIPS product identifier to a “**CEM**” CRS Weather Message.

Once all products have been configured for your site as needed, you are ready to move on to the Summary Message Configuration tab.

### **Tab 3 – Summary Message/Miscellaneous Settings Configuration**

After you have set properties for all your products, the next step is to configure summary message settings. The summary message can be a powerful addition to your CRS product suite. Generating a summary of active hazards was a function of the WWA NWR formatters.

The basic function of the NWRWAVES summary message function is as follows: sites can configure their product configuration settings to select which (if any) product types are tracked by NWRWAVES for summarization purposes. Once a local threshold is exceeded, NWRWAVES will generate a message summarizing any applicable hazards. The summary message can be used within a regular Broadcast Suite to bring a periodic short summary of these hazards, or the summary message can itself be used to trigger a higher suite on your CRS, thus shortening a lengthy broadcast if many hazards are in effect.

In the NWRWAVES Setup GUI, click on the third tab, which is labeled **Summary Message/Misc. Settings**

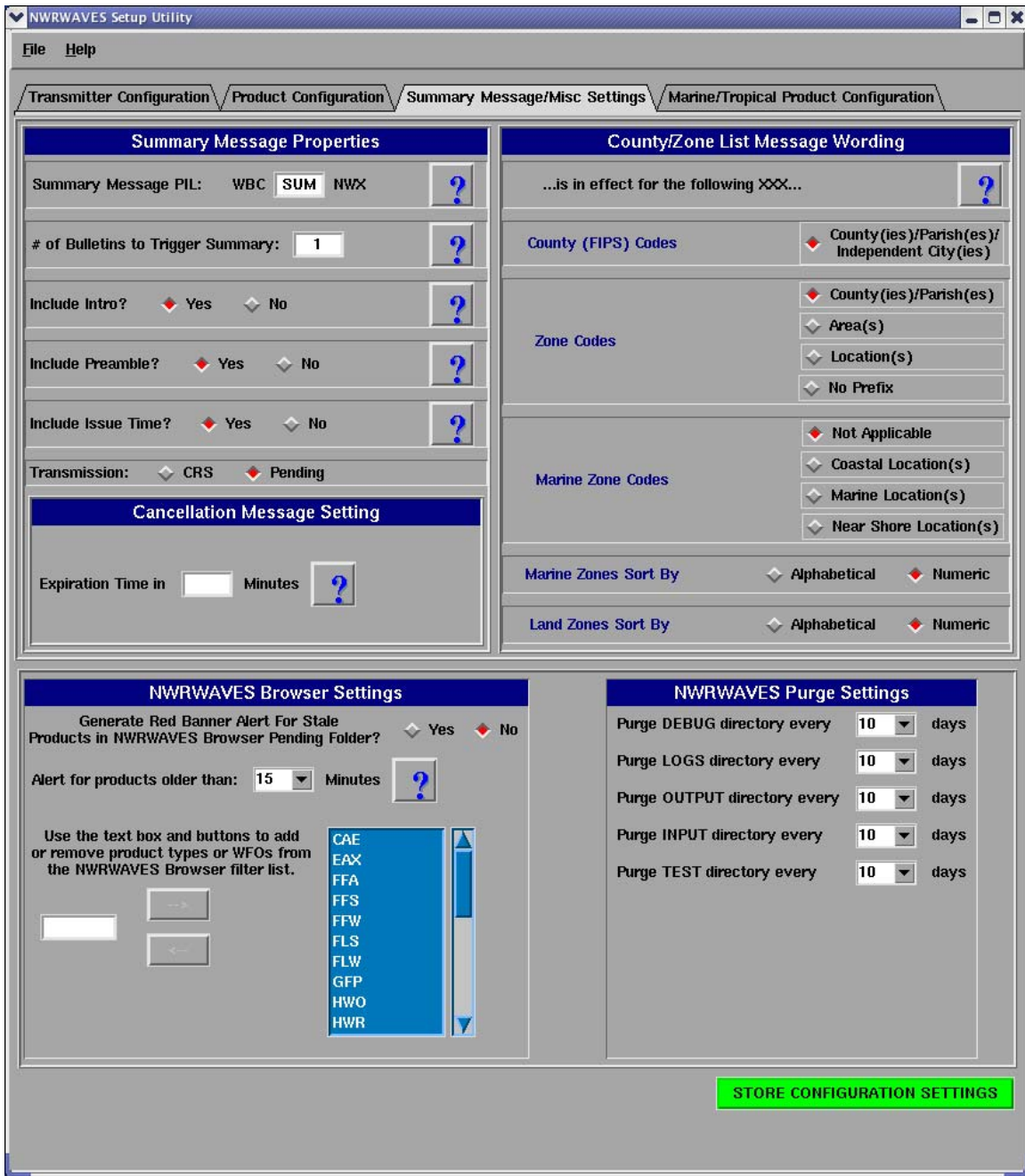

**Figure 5 – Summary Message Configuration Tab**

Under this tab you can select the following options:

- 1) **Summary Message PIL:** Your AWIPS legacy state node will make up the first three letters of the summary PIL, and the last three letters (labeled 'NWX' on the GUI) will be the unique three-letter mnemonic that you gave each of your transmitters. You can select the middle three letters of the summary message. For example, for transmitter MCI for the Kansas City office (state node is STL), the summary message type (from the GUI above) would be 'STLSUMMCI'.

- 2) **# of Bulletins to Trigger Summary:** This is the minimum number of active hazards (with the summary message option set to “YES” in the product configuration) that are required before NWRWAVES begins to generate a summary message.
- 3) **Include intro (yes/no):** If “Yes” is selected, NWRWAVES will include the text, “The following watches (warnings) (and advisories) is/are in effect” as an intro phrase for its summary of active hazards.
- 4) **Include Preamble (yes/no):** The same as the Product Configuration setting, if this is set to “Yes”, then NWRWAVES will include the preamble in its intro phrase for the summary message.
- 5) **Include Issue Time? (yes/no):** Identical to the Product Configuration setting, if this is set to “Yes”, then NWRWAVES will include the time the summary message was prepared in the intro phrase of the summary message.
- 6) **Transmission:** You can set whether the summary message is sent directly to CRS for airplay, or whether it gets placed in the ‘Pending’ side of the NWRWAVES Browser. The default setting is set to ‘Pending’.

The top right hand side of the GUI contains settings that affect the wording of the summary message, as well as the wording of the optional lead-in and county/zone listing phrases by transmitter (that you established under Tab 1 earlier):

- 7) **County (FIPS) Codes:** If this radio button is selected, NWRWAVES will include the words ‘county’, ‘parish’, ‘counties’, ‘parishes’, or ‘independent city(ies)’ after its summary phrase “for the following”. Proper wording will be used for whether the FIPS code is for a county, a parish, or an independent city.
- 8) **Zone codes:** You can govern (by selecting the appropriate option) whether for UGZ codes NWRWAVES follows its summary phrase “for the following” with the word ‘county (parish), counties (parishes)’, ‘area(s)’, ‘location(s)’, or simply nothing at all.
- 9) **Marine zones codes:** Functions like #8 but for marine zones. Options are to follow the phrase “for the following” with nothing, ‘coastal location(s)’, or ‘marine location(s)’.
- 10) **Marine Zones Sort By: Options are Alphabetical or Numeric.**
- 11) **Land Zones Sort By: Options are Alphabetical or Numeric.**

The bottom left hand side of the GUI contains settings that affect the NWRWAVES Browser:

- 12) **Generate Red Banner Alert for Stale Products in NWRWAVES Browser Pending Folder:** the NWRWAVES Browser provides an optional D2D red banner alert when products have become stale in the Pending side of the browser. This option is designed to prompt the forecaster/HMT to take an action on these messages -- transmit or delete them. To turn this feature on, simply check the “Yes” option box and then set the time duration at which products in the Pending side of the browser will become “stale” and generate the red banner alert.
- 13) The NWRWAVES Browser also provides a means of allowing a user to filter the Sent list by one or more products. Previously the default list of available products could be modified by editing a text file. This has been integrated into the GUI. To Add/Remove product types from the NWRWAVES Browser filter list, simply use the GUI provided. To Add a product, enter its ID into the text box and click the right arrow. To Remove a product, select it with the left mouse from the list and click the left arrow button.

The bottom right hand side of the GUI contains settings that affect NRRWAVES purging capabilities.

- 14) On the bottom right hand side of the GUI, you can change the number of days that NRRWAVES will store output and debug related files in the following directories: DEBUG, LOGS, OUTPUT, INPUT and TEST. It is recommended that you keep this number at least 10 days for troubleshooting purposes, but not more than 15 days. A cron task will automatically purge files older than the number of days established in this section.

When you are satisfied with the summary settings, click the green **“STORE CONFIGURATION SETTINGS”** to save them.



**You have now configured the first three tabs of the NRRWAVES Setup GUI. If your site is not a coastal site, and you have no marine responsibilities, you have completed the software configuration, and you may exit the NRRWAVES Setup GUI (File pull-down menu, click “Save and Exit”). You may proceed directly to [Section 4 – Setting AWIPS Text Database Triggers](#), to configure AWIPS to send products through NRRWAVES.**

If you do have marine responsibilities or are a coastal office, you must complete Tab 4 – Marine/Tropical Product Configuration before you are done.

#### **Tab 4 – Marine/Tropical Product Configuration**

Most marine products will play through NRRWAVES with little customization needed for the individual products. Extensive work in the word replacement dictionary (Section 6) or VIP will be needed to replace acronyms and abbreviations with full word phrases, to render a quality NWR product.

There are four main sections under the Marine/Tropical Product Configuration Tab (Figure 6), **Marine VTEC Processing, Hurricane Local Statement, Tropical Storm Product and Great Lakes Forecast.**



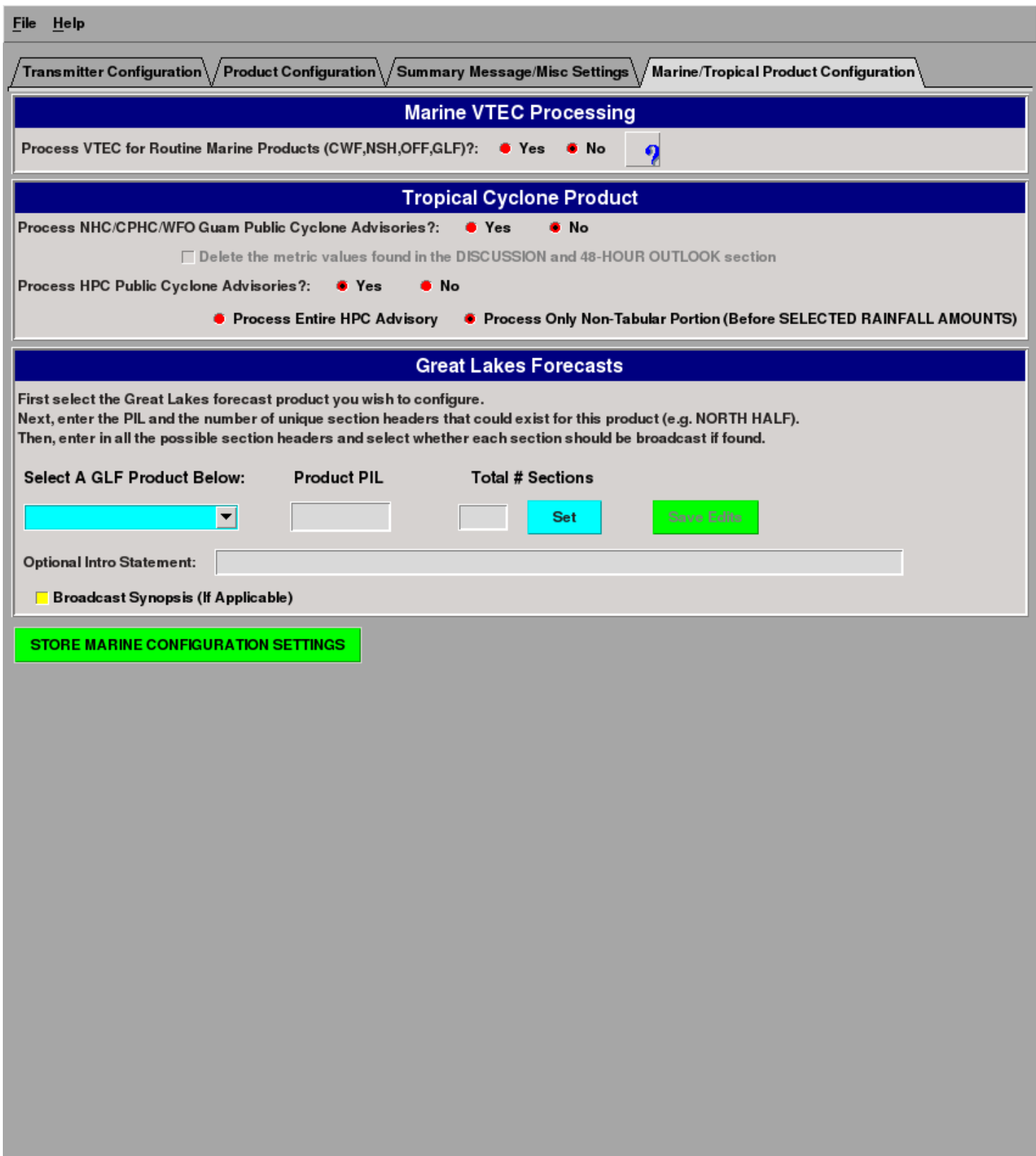

Figure 6 – Marine/Tropical Product Configuration GUI

### *Marine VTEC Processing*

Next to the label “Process VTEC for Routine Marine Products (CWF, NSH, OFF, GLF)?” is a ‘yes/no’ option. Check ‘yes’ to enable VTEC usage in your marine products. Check ‘no’, and NWRWAVES will process all marine products but ignore any VTEC lines. **NOTE:** see pages 11 and 12 of NWRWAVES documentation for details on whether you choose to use or not use VTEC with your marine product suite.

### *Hurricane Local Statement*

In OB14.3.2, a couple of new features related to the processing of the HLS products have been introduced. Please refer to the Appendix- F for details.

### *Tropical Cyclone Product (TCP)*

From the 2010 hurricane season on, only the “DISCUSSION AND 48-HOUR OUTLOOK” text section of the TCP products (see Figure-6 highlighted in red) will be processed by the NWRWAVES. The others sections of the TCP text will be discarded in order to reduce the broadcast cycles in the NWR.

There are two options you can configure in this section that affect processing of the TCP product from TPC and HPC.

- 1) Process NHC Public Cyclone Advisories? (yes/no): if this is set to ‘No’, then NWRWAVES will **not** process the TCPAT(x) bulletins issued by the Tropical Prediction Center, even if you have the text database trigger set to send the TCPAT(x) bulletin to NWRWAVES. **If the answer is set to “Yes”, you also have additional option to delete the metric values found in the DISCUSSION AND 48-HOUR OUTLOOK section. All the metric speed (in KM/HR) or distance (in KM) values can be filtered out. NOTE: The administrator must select this option from the GUI first since the default is not to delete the metric values.**
- 2) Process HPC Public Cyclone Advisories? (yes/no): this flag tells the software whether to ignore or process the TCPAT(x) issued by the HPC once a tropical system has made landfall. If the answer is set to “Yes”, you also have additional flags to either read the entire advisory as written, or to filter out any tabular data (such as inland rainfall totals) that HPC may include in the product.

### **SPECIAL NOTES ON TROPICAL CYCLONE PRODUCT PREPARATION**

NWRWAVES functions much differently than CAFÉ with respect to its tropical cyclone message generation. CAFÉ would process the TPC TCPAT(x) bulletins, and through the use of phrase searches and key wording, CAFÉ would then generate an output message customized by a latitude/longitude box, and where the storm was with respect to this box. If it met certain phrase and location criteria, the inbound CRS Weather Message would be assigned the proper EAS code (TRA, TRW, HUA, HUW) for alert on NWR.

NWRWAVES treats the TCP just like the HLS, as a regular product that contains information on the storm. **NOTE: A strong recommendation for sites is that they should invoke Generic Message Type assembly for the TCP product in NWRWAVES, so as to minimize the delay of producing transmitter specific output.** The product suite needed to process hurricane watch/warning and tropical storm watch/warning bulletins is the new HLS instead of the TCV or TCVAT(x) suite issued by the TPC since the HLS is carrying the same VTEC. If a site has both HLS and TCV, there will be failures of the HLS.

**NOTE:** You will need text database triggers for HLS to properly prepare and disseminate tropical watches and warnings. Text database triggers are covered in Section 4.

### ***Great Lakes Forecasts***

The Great Lakes Forecast (GLF) section is used to configure how the GLF is formatted for airplay. These capabilities replace the customized settings found in the CAFÉ GLF formatter. **Effectively October 2007, all GLF would change from the non-segmented format to a new segmented format that would allow WFOs issuing the GLF products to be more area-specific. For example, the geographic divisions used in the GLF such as “NORTH HALF” will be replaced by smaller marine zones grouped in segments by similar weather conditions. The old non-segmented format will be completely removed in OB9 release.**

To configure (if needed) the Great Lakes Forecast options, complete these steps:

- 2) Choose a Great Lake from the **Select a GLF Product Below** dropdown list.
- 3) Enter the AWIPS product identifier for the GLF (example CHIGLFLM).
- 4) Enter total number of possible breakpoint sections in the GLF (usually, this is denoted within the text of the product such as “NORTH HALF”, “SOUTH HALF”, etc.) This should include all possible breakpoints.
- 5) Click the **Set** button
- 6) Edit the **Optional Intro Statement** if desired. Any text entered will be used as an intro phrase for the GLF output.
- 7) Click the **Broadcast Synopsis (If Applicable)** button if desired. If this is checked, the “.SYNOPSIS” section of the GLF will be included in the CRS output, otherwise it will be omitted.
- 8) Fill in the **SECTION HEADERS** entry boxes to reflect the break points used in the GLF. Again, an example would be phrases such as “NORTH HALF” and “SOUTH HALF”.
- 9) For each SECTION HEADER, click each transmitter checkbox that you wish to have formatted for airplay. (This feature allows WFO’s to assign certain GLF sections to certain transmitters).

In Figure 6 above, the configuration settings for the GLF are as follows:

- Process the AWIPS product (if triggered) CLEGLFLE for Lake Erie
- Do not include any intro statement
- Broadcast the “.SYNOPSIS” section within the output of the CRS GLF forecast
- Section headers (as defined) would only play for those transmitters checked for each header. .

When you have completed all applicable sections of this tab, click the green **STORE MARINE CONFIGURATION SETTINGS** button to save your settings. You can also establish periodicity and/or effective time settings for the GLF under the product configuration tab. **NOTE: if you checked the option “No” for using VTEC for marine products, the “GLF” entry is the option you’ll need to configure. Otherwise, you will need to configure for each individual VTEC header to accomplish this task.**

You have now completed customization of NRRWAVES for your office. Proceed to **Section 4 – Setting AWIPS Text Database Triggers**, to configure AWIPS to send products through NRRWAVES.

## **5. SETTING AWIPS TEXT DATABASE TRIGGERS**

NRRWAVES software is executed as an automated response to an AWIPS text database trigger (Informix OB5 and earlier, Postgres after OB6). Offices that have used CAFÉ will notice some degree of familiarity in the establishment of database triggers.

You can, and should, run triggers for both your CAFÉ and NRRWAVES formatters during the transition period between CAFÉ and NRRWAVES. You can run NRRWAVES in a test mode, which is what you will need to do in this transition period to ensure a smooth switch between the two formatters. Once you decide to switch a product/products over to NRRWAVES in an operational mode, you would need to remove the legacy CAFÉ triggers. To establish a suite of triggers needed for NRRWAVES operation, perform the following steps:

## **AWIPS I platform**

1) Log into an AWIPS workstation with a user account that has fxalpha group privileges and open up a terminal window.

2) Change directories to the trigger directory.

```
cd /data/fxa/siteConfig/textApps
```

3) Make a backup copy of your site trigger information, in case you need to revert back to it.

```
cp siteTrigger.template siteTrigger.template.mmddyyyy
```

where '**mmddyyyy**' is the numeric current date

4) Edit your site trigger configuration.

```
gedit siteTrigger.template &
```

When you view this file, you will see a listing of AWIPS product identifiers, along with an action that is to be completed upon receipt of that product identifier into the text database. If you are a CAFÉ site, there will be several entries that call CAFÉ scripts to format data. An example of a CAFÉ entry in your site trigger configuration will look something like the following:

```
STLSVREAX /home/CRS/SVR/nwrsvr.csh STLSVREAX
```

**Do not change or remove these CAFÉ text database triggers!** Your initial configuration will be to set NRRWAVES into test mode, so you can monitor its performance and ensure that it will work successfully with your CRS database prior to making the switch over to operational mode. The WWA NWR formatters do not use text database triggers.

5) For each text product that you wish to be formatted by NRRWAVES, you will need to add a line to the siteTrigger.template file using the following syntax (CCNNNXXX is the 8/9 letter product PIL):

```
CCNNNXXX /awips/adapt/NRRWAVES/nwrwavetest.csh
```

The script '*nwrwavetest.csh*' is used by NRRWAVES to execute the formatter in TEST mode.

You will need an entry for each product that you wish to send through NWRWAVES. This entry (the CCCNNNXX field) is the exact AWIPS product identifier for each product you wish to process! **An example of text database triggers set at WFO Pleasant Hill for NWRWAVES execution can be found in Appendix B.**

## **SPECIAL NOTES REGARDING TEXT DATABASE TRIGGERS**

### **NWEM messages:**

Sites **do not need** to add any triggers for their NWEM messages. In OB9.1 or older NWEM messages are formatted out of HazCollect, and HazCollect will call its own **Café NWEM formatter** internally.

**Starting with AWIPS OB9.2 NWRWAVES will automatically become the default formatter for processing all NWEM messages. The old standalone Café NWEM formatter will cease to be used for HazCollect NWEM products. The purpose of the switch is to provide HazCollect with Spanish support and to resolve issues that existed in the legacy Café formatter. It should be noted that installation of OB9.2 is the preferred manner to migrate from the Café NWEM formatter to NWRWAVES. If sites are unable to install AWIPS OB9.2 due to emergency circumstances and would like to **MANUALLY** migrate Café NWEM to NWRWAVES for HazCollect, the following instructions should be executed:**

1. log in as fxa username
2. cd /awips/fxa/bin
3. cp /awips/fxa/bin/transmitHazardWarnings.pl /awips/fxa/bin/transmitHazardWarnings.plORG
4. make the following changes

In the send to CRS section of the **transmitHazardWarnings.pl** script change

from

```
my $formatter = "/home/CRS/NWEM/nwrnwem.csh $product_id $crs_section $trans_file";
```

to

```
my $formatter = "/awips/adapt/NWRWAVES/nwrwaves.csh $product_id";
```

5. Save of the **transmitHazardWarnings.pl** script
6. ls -lart transmitHazardWarnings.pl

Make sure the permission, owner and group should look like the below example

```
-r-xr-xr-x 1 fxa fxalpha 29964 Aug 10 2009 transmitHazardWarnings.pl
```

### **Convective watches:**

CONUS sites will need to include all ten WOU(x) products issued by the Storm Prediction Center, along with all WCN products that apply to your CRS broadcast service areas. OCONUS sites only need the WCN products. For the WCN products, these will include your WCN, and any WCN's issued by surrounding offices. For the WOU(x) products, a section of your siteTrigger.template will need to include these entries:

<b>CCCWOU0</b>	<b>/awips/adapt/NWRWAVES/nwrwavestest.csh</b>
<b>CCCWOU1</b>	<b>/awips/adapt/NWRWAVES/nwrwavestest.csh</b>
<b>CCCWOU2</b>	<b>/awips/adapt/NWRWAVES/nwrwavestest.csh</b>
<b>CCCWOU3</b>	<b>/awips/adapt/NWRWAVES/nwrwavestest.csh</b>
<b>CCCWOU4</b>	<b>/awips/adapt/NWRWAVES/nwrwavestest.csh</b>
<b>CCCWOU5</b>	<b>/awips/adapt/NWRWAVES/nwrwavestest.csh</b>
<b>CCCWOU6</b>	<b>/awips/adapt/NWRWAVES/nwrwavestest.csh</b>
<b>CCCWOU7</b>	<b>/awips/adapt/NWRWAVES/nwrwavestest.csh</b>
<b>CCCWOU8</b>	<b>/awips/adapt/NWRWAVES/nwrwavestest.csh</b>
<b>CCCWOU9</b>	<b>/awips/adapt/NWRWAVES/nwrwavestest.csh</b>
<b>CCCWCNXXX</b>	<b>/awips/adapt/NWRWAVES/nwrwavestest.csh</b>

CCC should be set to your legacy state node for all WOU products and for your **WCNXXX** product. CCC should be set to the legacy state node for all other office **WCNXXX** products that you need to cover your broadcast service areas.

For tropical cyclone products needed to generate Tropical Storm Watches/Warnings, and Hurricane Watches/Warnings, you will need to include HLS products issued by the WFOs. If your site is a coastal office, for the HLS product, a section of your siteTrigger.template file will need to include these entries:

<b>CCCHLSXXX</b>	<b>/awips/adapt/NWRWAVES/nwrwaves.csh</b>
------------------	-------------------------------------------

**NOTE:** The current OB9 version does not support the TEST mode for HLS product.

- 6) After you have finished adding in the suite of triggers, we will need to save the file and re-localize for these new text database triggers.
- 7) **If your site is on AWIPS II software, log onto the DX3 or DX4.**

```
su - fxa ( or as root)
cd /data/fxa/sdc
./config_awips.sh trigger XXX (where XXX is the 3 characters siteID)
```

- 8) Change user to fxa and type the following commands:

```
su - fxa
cd /awips/fxa/data/localization/scripts
./mainScript.csh -trigger
```

## **AWIPS II platform**

Triggers in AWIPS II are run as edex Subscriptions and not as postgres database triggers.

You can view your current AWIPS II triggers/subscriptions via the following command which should be issued from DX1:  
**/awips2/fxa/bin/subscription -o read -p PIL**

If you find that you need to add triggers/subscriptions, the subscription command should not be used to add or delete triggers. Use siteTrigger.template and config\_awips2.sh.

**Note: Please see attachment D for adding/deleting/updating text database triggers if needed.**

The end result of completing steps (1) through (8) is that NWRWAVES will begin to process products in TEST mode for your site. In TEST mode, generated CRS output will be placed in the /awips/adapt/NWRWAVES/TEST directory instead of being sent to CRS or the 'Pending' side of the NWRWAVES Browser. You can use your favorite editor, viewer or browser to review the output over time, to ensure that NWRWAVES is processing inbound data and producing correctly formatted outbound CRS products.

The end result of completing steps (1) through (8) is that NWRWAVES will begin to process products in TEST mode for your site. In TEST mode, generated CRS output will be placed in the /awips/adapt/NWRWAVES/TEST directory instead of being sent to CRS or the 'Pending' side of the NWRWAVES Browser. You can use your favorite editor, viewer or browser to review the output over time, to ensure that NWRWAVES is processing inbound data and producing correctly formatted outbound CRS products.



**Having completed Sections 1 through 4 through this point, you have successfully configured NWRWAVES for your local site. You have established transmitters (broadcast programs) with the appropriate listing of county (parish), independent cities and zone codes. You have customized your product list for processing, and you have established the AWIPS products from your text database that are to be processed through NWRWAVES.**

**NWRWAVES is now running on your AWIPS in TEST mode.**

The end result of your work to date will be visible in the /awips/adapt/NWRWAVES/TEST directory, where NWRWAVES will place its output for your review. You will need to run in TEST mode until you have the opportunity to properly configure your CRS database in Section 5, and you also have the chance to review NWRWAVES output and validate that it is working properly. Do not plan to transition to an operational mode until both of these have been accomplished and the results are acceptable to you.

**Perform steps 9 through 15 below only when you are ready to begin operational use of NWRWAVES. TRANSITIONING PRODUCTS TO OPERATIONAL MODE**

When you are ready to begin transitioning NWRWAVES to operational status, you can do this on a product-by-product basis. **Do not plan to move from TEST to OPERATIONAL mode in NWRWAVES** until you ensure your CRS is correctly configured to accept the format of Weather Messages from NWRWAVES.

**Section (5) – NWRWAVES AND YOUR CRS DATABASE** gives you the information you need to ensure your CRS is ready to accept NWRWAVES output.

The steps necessary to transition a product or products to operational mode are as follows:

- 9) Repeat step (1) through step (7) above in Section 4. For all instances of a product in step (5) that you wish to transition to operational status, replace the call:

**`/awips/adapt/NWRWAVES/nwrwavestest.csh`**  
**with**  
**`/awips/adapt/NWRWAVES/nwrwaves.csh`**

- 10) Remove the associated CAFÉ trigger for this product.

**NOTE:** There may be multiple AWIPS product identifiers for this product if you format other WFO AWIPS products for this CRS product type. Be sure to remove all applicable CAFÉ product triggers for this product or you will see duplicate CRS Weather Messages!

**NOTE:** If you are a site that uses the WWA NWR formatters, you will need to go into the WWA Admin GUI and disable NWR formatting for this product type. Alternatively, you can use GHG in lieu of WWA, as the WWA NWR formatter only works for products actually prepared through WWA.

- 11) Repeat steps (7) and (8) to re-localize your new triggers to establish this set of new products to operational mode.

Once you have set the products to process operationally, the resultant CRS output will (by default) be placed in the ‘Pending’ side of the NWRWAVES Browser. This is because your Product Configuration was set to place the output there in your original configuration. To facilitate automated transmission to CRS:

- 12) Go back to Section 3 – Tab 2.  
 13) Repeat steps (1), (2) and (3r) under the ‘Product Configuration’ tab. You will be switching the “Transmission Status” section from ‘Pending’ to ‘CRS’ (Figure 7).  
 14) Click the green “**SAVE EDITS**” button to save the product configuration  
 15) Repeat steps (13) and (14) above for all products you are transitioning to operational mode and automated CRS broadcast.

The screenshot shows a configuration panel with the following settings:

- Storage: VIP (Default) [?]
- Transmission Status:  CRS  Pending [?]
- Periodicity: [ ] Minutes [?]
- CRS Effective Time: [ ] minutes after the hour [?]
- Default Duration: 60 Minutes [?]
- Use if UGC expiration missing  Use in lieu of UGC

**Figure 7 – example of Transmission Status set to automated relay to CRS**

**Selectively specify transmission status based on issuing WFO in OB9:**

In OB9, The local WFO will have the capability to place specified products particularly for other offices’ products to go to the Pending window for further review/editing if necessary. A new input argument (e.g. – EXTERNAL with 2 dashes) can be passed to the nwrwaves.csh to redirect the output to the Pending directory as follow:

**`CCCZFPXXX /awips/adapt/NWRWAVES/nwrwaves.csh -- EXTERNAL`**



The example CCCZFPXXX product will appear in the ‘Pending’ side of the NWRWAVES Browser. Manual intervention through the browser will be required to send the output to CRS.

## 6. NWRWAVES AND YOUR CRS DATABASE

NWRWAVES was initially designed to produce transmitter (broadcast program) specific output, to best focus the content of Weather Messages on the listening area of that transmitter. In this paradigm, unique CRS Weather Messages would be produced for each product, or each segment within a segmented product, using a standardized naming scheme.

After NWRWAVES deployment, issues were noted regarding the volume of messages produced by NWRWAVES, and the subsequent affect that multiple transmitter-specific messages were having on the CRS architecture (specifically the VIP processor). As a result of these issues, **NWRWAVES allows an office to opt for transmitter specific –OR- “generic” message assembly**. If a site opts for generic Message Type assembly, only one Weather Message will be produced for CRS per each valid product segment; its ultimate destination on your CRS Broadcast Cycles will be governed by the LAC’s assigned to the message.

**NOTE:** Generic message type assembly is **STRONGLY** recommended for all short-fuse warning products (**SV.W, TO.W, FFW, FFS, FF.W**) so as to minimize delays in VIP processing and subsequent alert tone broadcast. Generic message type assembly should also be invoked for products that yield identical output on each transmitter (i.e., RWS/SWS, PNS type products) and anything else that an office feels comfortable in switching.

The assembly of both types of messages is as follows:

### TRANSMITTER SPECIFIC MESSAGE TYPES

The standard nomenclature for a CRS Message Type is CCCNNNXXX. This format is very similar to AWIPS product identifiers. NWRWAVES prepares its transmitter specific Weather Messages for the three components (CCC, NNN, XXX) using the following logic:

**CCC** – derived from your AWIPS legacy state node environmental variable. This is sourced from the file /awips/fxa/data/localizationDataSets/XXX/AFOS\_CCC\_Name.txt. ‘XXX’ is your AWIPS site identifier.

**NNN** – the middle three letters will come from your settings for each product in the Product Configuration settings. Remember, the term ‘product’ is not just inclusive as a one-to-one relationship to an AWIPS product identifier. ‘Product’ refers to the combination of VTEC phenomenon and significance code when appropriate (several AWIPS product identifiers can have multiple VTEC phenomenon/significance code combinations such as the AWIPS WSW product). The middle three letters are either the “Initial Header” or “Followup Header” entries (based upon VTEC and follow-up statements) as you assigned back in Section 3 – Tab 2 (Figure 8).

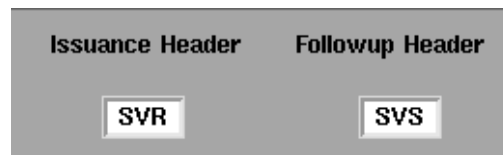

Figure 8 – an example of NWRWAVES product SV.W and it’s unique NNN codes assigned by this product type

**XXX** – the last three letters used in Weather Message assembly are the three-character mnemonics you assigned unique to each transmitter back in Section 3 – Tab 2.

In the case of the Kansas City/Pleasant Hill office, our AFOS state node identifier is STL. We have eight transmitters (MCI, STJ, IRK, MIA, CRL, CLN, MYV, TTN). Therefore, for the NWRWAVES product SV.W (Severe Thunderstorm Warning) as shown above in Figure 8, an inbound AWIPS product of STLSVREAX for all of our CWA would yield the following Weather Messages (depending on the VTEC action code):

**Initial Issuance (/O.NEW.KEAX.SV.W)**

STLSVRMCI  
STLSVRSTJ  
STLSVRIRK  
STLSVRMIA  
STLSVRCRL  
STLSVRCLN  
STLSVRMYV  
STLSVRTTN

**Follow-up Issuance (/O.CON.KEAX.SV.W)**

STLSVSMCI  
STLSVSSTJ  
STLSVSIRK  
STLSVSMIA  
STLSVSCRL  
STLSVSCLN  
STLSVSMYV  
STLSVSTTN

For non-VTEC coded products, the only header that will be used by NWRWAVES will be the “Issuance Header” entry, as there is no way to accurately determine if the product is an initial issuance or a follow-up. Thus, you will only need to ensure the presence of the list under the “Issuance Header” in your CRS database.

Therefore, in your CRS database, you will need to ensure that for every product you produce through NWRWAVES, you have a unique Message Type defined that matches this naming scheme, for both VTEC and non-VTEC products. In the case of the Pleasant Hill office where we have eight (8) transmitters, every VTEC encoded product will yield a maximum of **16 unique Message Types**, and a **maximum of eight unique Message Types** for every non-VTEC product (or VTEC product where the two headers are the same).

**GENERIC MESSAGE TYPES**

In generic message type assembly, NWRWAVES makes extensive use of the inbound AWIPS product identifier (PID) for assembling its equivalent Message Type). **For all inbound AWIPS PID’s that are nine characters in length (i.e., “STLRWSEAX”), the resulting outbound CRS Message Type used will match the inbound product’s identifier exactly (STLRWSEAX). If the inbound AWIPS PID is an eight character identifier (i.e., “STLRWSSMO”), NWRWAVES will yield a nine character Message Type using the logic below (in this case, STLRWSSMO).**

NWRWAVES prepares its transmitter specific Weather Messages for the three components (**CCC**, **NNN**, **XXX**) using the following logic:

**CCC** – derived from the first three letters of the AWIPS Product Identifier (PID) from the inbound product.

**NNN** – the middle three letters will come from your settings for each product in the Product Configuration settings. Remember, the term ‘product’ is not just inclusive as a one-to-one relationship to an AWIPS product identifier. ‘Product’ refers to the combination of VTEC phenomenon and significance code when appropriate (several AWIPS product identifiers can have multiple VTEC phenomenon/significance code combinations such as the AWIPS WSW product). The middle three letters are either the “Initial Header”

or “Followup Header” entries (based upon VTEC and follow-up statements) as you assigned in Section 3 – Tab 2 above (Figure 8).

**XXX** – the last three letters used in Weather Message assembly are the last three characters of the AWIPS PID.

In the case of the Kansas City/Pleasant Hill office, our AFOS state node identifier is STL. We have eight transmitters (MCI, STJ, IRK, MIA, CRL, CLN, MYV, TTN). Therefore, for the NWRWAVES product SV.W (Severe Thunderstorm Warning) issued from Pleasant Hill, an inbound AWIPS product of STLSVREAX for all of our CWA would yield the following Weather Messages (depending on the VTEC action code):

**Initial Issuance (/O.NEW.KEAX.SV.W)**  
STLSVREAX

**Follow-up Issuance (/O.CON.KEAX.SV.W)**  
STLSVSEAX

For the NWRWAVES product SV.W (Severe Thunderstorm Warning) issued from Des Moines, an inbound AWIPS product of DSMSVRDMX would yield the following Weather Messages (depending on the VTEC action code):

**Initial Issuance (/O.NEW.KDMX.SV.W)**  
DSMSVRDMX

**Follow-up Issuance (/O.CON.KDMX.SV.W)**  
DSMSVSDMX

For the NWRWAVES product RWS (Regional Weather Synopsis) issued from Wichita, an inbound AWIPS product of TOPRWSKS would yield the following Weather Message:

**Any Issuance (non-VTEC coded product)**  
TOPRWSSKS

**NOTE:** since the inbound AWIPS PID was only eight characters, NWRWAVES assembles its last three characters of the Generic Message Type from the last three characters (SKS) of the AWIPS PID.

For non-VTEC coded products, the only header that will be used by NWRWAVES will be the “Issuance Header” entry, as there is no way to accurately determine if the product is an initial issuance or a follow-up. Thus, you will only need to ensure the presence of the list under the “Issuance Header” in your CRS database.

Therefore, in your CRS database, you will need to ensure that for every product you produce through NWRWAVES using Generic Message Type, you have a unique Message Type defined that matches this naming scheme, for both VTEC and non-VTEC products. In the case of the Pleasant Hill office where we cover seven (7) different offices and ourselves, we would have **8 unique Message Types per NWRWAVES product (16 for each product if the Issuance/Follow-Up headers are different like the TOR/SVS)**; one for each office’s AWIPS PID of their issuing product.

## **SETTING UP MESSAGE TYPES IN YOUR CRS DATABASE**

The preferred method to adjust and configure your CRS database is through the GUI system on your CRS MP workstation. Sites are discouraged from hand-editing a copy of their ASCII database, unless the site focal point has a thorough knowledge of its structure. Sites that have run the WWA NWR formatters in the past will already have many of these unique Message Types defined in their database, as WWA produced transmitter-specific

output. CAFÉ users will likely find a mix of unique and global Message Types depending on the AWIPS product identifier type.

The following is a recommended methodology to use in ensuring your CRS database is ready to accept output from NWRWAVES. It will work well in preparing CRS for NWRWAVES on a product-by-product basis.

**NOTE: Before you begin making any changes to your CRS database, use the OMP Database backup utility to make a good backup copy of your existing database before you begin! This way, if you need to revert back to the original database, you can do so.**

- 1) Choose a unique product that you wish to prepare and/or ensure your CRS database to accept.
- 2) Make note of the “Issuance Header” and “Followup Header” of that product in the NWRWAVES Product Configuration GUI (Section 3 – Tab 2). **NOTE: If this is a non-VTEC product such as the HWO, NOW, etc., you only need to note the “Issuance Header”.**
- 3) In the CRS Message Type GUI (on your MP), you can find the “Message Types” GUI under the ‘Messages’ pull-down menu. You have two options on how to proceed, preparing place holders for either transmitter specific or generic message types. **NOTE: If you already have transmitter-specific message types, you are advised to leave them be and only add those generic message types you need on a case basis.**

### **SETTING UP TRANSMITTER SPECIFIC MESSAGE TYPES**

For those that will involve tone alerts (WRSAME, or WRSAME and 1050Hz), you want to be sure that the only transmitter that has a red ‘check mark’ next to its label in the “SAME Transmitters” column is **the one that matches the last three letters of the Message Type**. If all the boxes are checked, then the inbound NWRWAVES product will tone alert multiple times, on multiple transmitters, in instances where an LAC overlaps multiple transmitters. Ensure that only one “SAME Transmitters” option is selected for each Message Type to prevent this from occurring.

Also, you will likely also want to **\*not\*** include these unique Message Types (if they are applicable watch/warning/advisory type products) in your Emergency Override product list. The list in Emergency Override can get quite lengthy, and the process of initiating multiple EO sessions can lead to too much work and a delay in getting a broadcast completed for multiple transmitters.

- a) If you already have unique CRS Message Types defined per transmitter, and these Message Types begin with your state node CCC and end in the three-character combinations you have set in your NWRWAVES transmitter configuration, you have the correct naming scheme for transmitter-specific products, and you can complete this step (3a). Otherwise, proceed to step (3b) below.

Ensure that **only one** ‘SAME Transmitters’ transmitter is checked as described above, if this Message Type is one that involved alert tones of any type. Make sure the ‘Emergency Override’ checkbox is not selected for this unique Message Type. Your Message Groups, Broadcast Suites (and triggers) will already contain these Message Types, and no additional work will be needed to facilitate NWRWAVES output from being scheduled on your CRS. Save the Message Type and proceed to step (4).

- b) If you already have unique CRS Message Types defined per transmitter, and these Message Types begin with your state node CCC but **\*do not\*** end in the three-character combinations you have set in your NWRWAVES transmitter configuration (say you have a scheme such as “NW1, NW2”, etc., and you wish to change these last three letters), complete this step (3b). Otherwise, proceed to step (3c) below.

Perform the following steps:

1. Call each Message Type up through the GUI.
2. Edit the Message Type XXX for each individual product (in the CCCNNNXXX format), and change the last three characters to match that of your transmitter.
3. Ensure that only one ‘SAME Transmitters’ transmitter is checked as described above, if this Message Type is one that involved alert tones of any type.
4. Make sure the ‘Emergency Override’ checkbox is not selected for this unique Message Type.
5. Save the Message Type.
6. Repeat (1.), (2.), and (3.) for all other existing Message Types of this particular product category.

The CRS software will take your changes to these existing Message Types and will propagate the adjusted Message Type identifiers through all existing Message Groups and Broadcast Suites (including triggers). Proceed to step (4).

- c) If you do not have unique CRS Message Types defined for each transmitter (say you have a global Message Type such as CCCSVRXXX such as in CAFÉ), you will need to add them to your CRS database. To do this:

1. Through the CRS Message Type GUI, create a new Message Type for a transmitter.
2. Establish its baseline attributes.
3. Ensure that only one ‘SAME Transmitters’ transmitter is checked as described above, if this Message Type is one that involved alert tones of any type.
4. Save the Message Type.
5. Repeat (1.), (2.), (3.) and (4.) to create Message Types of this particular product category for all transmitters.
6. You will then need to add these Message Types to any applicable Message Groups and/or Broadcast Suites for each transmitter.
7. Once the new Message Types have been assigned to a Broadcast Suite in some fashion, be sure to re-download the applicable Broadcast Programs to each transmitter. Proceed to step (4) below.

### **SETTING UP GENERIC MESSAGE TYPES**

For those that will involve tone alerts (WRSAME, or WRSAME and 1050Hz), you want to be sure that **all applicable transmitters** have a red ‘check mark’ next to their labels in the “SAME Transmitters” column. Since you’re opting to use Generic Message Type, LAC’s assigned to the product will govern which transmitter(s) are affected. Unlike the transmitter-specific product

assembly, there is no danger of the inbound NRRWAVES product tone alerting multiple times, on multiple transmitters, in instances where an LAC overlaps multiple transmitters.

You will likely **\*want\*** to include only one of these Generic Message Types (if they are applicable watch/warning/advisory type products) in your Emergency Override product list. The one you'll likely want to include will be the one for the product issued from your office (as it will be included in every transmitter's Broadcast Suites).

- d) If you already have generic CRS Message Types defined in your database, and these Message Types mirror the issuing office's AWIPS PID for those particular products (i.e., the old CAFÉ configuration for much of your short-fuse warning products), you have the correct naming scheme for generic products, so you can complete this step (3d). Otherwise, proceed to step (3e) below.

Ensure that **all applicable** 'SAME Transmitters' transmitter buttons are checked as described above, if this Message Type is one that involved alert tones of any type. Make sure the 'Emergency Override' checkbox is not selected for this unique Message Type. Your Message Groups, Broadcast Suites (and triggers) will already contain these Message Types, and no additional work will be needed to facilitate NRRWAVES output from being scheduled on your CRS. Save the Message Type and proceed to step (4).

- e) If you already have generic CRS Message Types defined in your database, but these Message Types do not match the naming scheme invoked by NRRWAVES, complete this step (3e). Otherwise, proceed to step (3f) below.

Perform the following steps:

1. Call each Message Type up through the GUI.
2. Edit the Message Type XXX for each individual product (in the CCCNNNXXX format), and change the first and/or last three characters to match the naming scheme used by NRRWAVES.
3. Ensure that all applicable 'SAME Transmitters' transmitters are checked as described above, if this Message Type is one that involved alert tones of any type.
4. Make sure the 'Emergency Override' checkbox is not selected for this unique Message Type.
5. Save the Message Type.
6. Repeat (1.), (2.), and (3.) for all other existing Message Types of this particular product category.

The CRS software will take your changes to these existing Message Types and will propagate the adjusted Message Type identifiers through all existing Message Groups and Broadcast Suites (including triggers). Proceed to step (4).

- f) If you do not have global CRS Message Types defined, you will need to add them to your CRS database. To do this:

1. Through the CRS Message Type GUI, create a new Message Type for a transmitter. Remember that the naming scheme will mirror the AWIPS PID of the inbound office's product if it is nine characters in length; if it is eight characters, the last three characters of the CRS Message Type will be the right three characters of the AWIPS PID.
2. Establish its baseline attributes.
3. Ensure that all applicable 'SAME Transmitters' transmitters are checked as described above, if this Message Type is one that involved alert tones of any type.
4. Save the Message Type.
5. Repeat (1.), (2.), (3.) and (4.) to create Message Types of this particular product category for all transmitters.
6. You will then need to add these Message Types to any applicable Message Groups and/or Broadcast Suites for each transmitter.

Once the new Message Types have been assigned to a Broadcast Suite in some fashion, be sure to re-download the applicable Broadcast Programs to each transmitter. Proceed to step (4) below

- 4) Once you have established any needed Message Types for this particular hazard, it is recommended that you also create (if you don't have one already as in the generic message type assembly) a generic Message Type for this NWRWAVES product. The generic Message Type would have the format CCCNNNXXX, where the 'XXX' in this case would be your office AWIPS identifier. At Pleasant Hill, we used the format **STLNNNEAX** for all our generic Message Types. **NOTE: if you have defined generic message types in steps 3(d) through 3(f), you can simply use the one for your office's product for your manual recording needs.**

For the generic message type that matches your offices issuing AWIPS PID, ensure that **all applicable** 'SAME Transmitters' transmitters are checked as described above, if this Message Type is one that involved alert tones of any type. Also, **use this one (if needed) as the ONLY one set to appear in your Emergency Override GUI (this is a check box on the Message Type GUI).**

In addition to CRS/VIP loading issues through NWRWAVES, the generic Message Type is quite useful for manual recordings, should NWRWAVES fail for any reason. Since the Message Type is assigned to all transmitters and can be scheduled for any transmitters, if an office has to send a warning via EO, the operator only has to make the one 'live' broadcast and then have the message go into all applicable transmitter programs. If a site uses the specific Message Types for their EO entries, the NWR Operator will have to send the 'live' warning multiple times, once for each specific Message Type.

- 5) Repeat steps (1) through (4) for the "Followup Header" settings if the AWIPS product for this hazard is a VTEC product, and this entry is different from the "Issuance Header". If both are the same, you can skip step (5).
- 6) Repeat steps (1) through (5) for NWRWAVES products as you are ready, to ensure they are ready for transition into an operational NWRWAVES environment.

## **IMPORTANT NOTES ABOUT CRS MESSAGE TYPES AND YOUR CRS DATABASE**

Some helpful hints as you transition from existing NWR formatters (WWA NWR, CAFÉ) to NWRWAVES:

- a) If you opt to use the approach of having transmitter-specific Message Types in your database for NWRWAVES, also have a generic Message Type for that same NWRWAVES product to create an optimal CRS operating environment. For the NWRWAVES product WS.W (Winter Storm Warning) in the Pleasant Hill CRS database (we have eight transmitters), we have nine different Message Types. We include the generic STLWSWEAX Message Type in our Emergency Override GUI for manual recording purposes. Any warning or update for any transmitter can be broadcast through EO; then it can be scheduled on any applicable transmitter with nominal work.
- b) Utilize the generic Message Type for all short-fuse warning products (SV.W, TO.W, FFW, FFS, FF.W) so as to minimize the amount of time it takes to process a warning through VIP and ultimately to the air on CRS. Sites should also look to maximize the use of generic Message Type wherever possible for messages that will feature the same content regardless of approach (RWS, PNS, RER).
- c) **Do not delete, change or remove any existing Message Types that are used by your operational NWR formatter until you have fully switched that product to operational status in NWRWAVES!** Once you make the full transition to NWRWAVES for this particular product, you can safely remove any legacy Message Types through the CRS GUI interface.
- d) Make sure that for any transmitter-specific Message Type that is used for tone-alert products, that the only ‘SAME Transmitter’ checked in the list is the one whose three-character mnemonic matches that of the last three letters of the Message Type. This will prevent multiple alerts being sent for products that involved LAC(s) shared amongst more than one transmitter. Make sure any generic Message Type used for alert purposes has all applicable ‘SAME Transmitters’ checked on the Message Type GUI.
- e) A suggested transition is to make the switch on a product-by-product basis. This will avoid wholesale changes to your CRS database at one time. Also, after each NWRWAVES product is configured with the Message Types needed in your CRS database (or a small subset of products), make a backup copy of that CRS database (through the OMP database backup utility) in case you need to revert back to a previous version.
- f) Remember, if you add new Message Types to your CRS database, you also need to add them to any applicable Broadcast Suites, and adjust any triggers as necessary to ensure proper broadcast of information.

## 7. NWRWAVES OPERATIONS

This section of documentation will describe the NWRWAVES Browser, NWRWAVES program execution, and detail the logging performed by NWRWAVES to assist in troubleshooting procedures.

### NWRWAVES BROWSER

The main interface that users will notice as they use NWRWAVES is the NWRWAVES Browser. This new browser will be linked during the install such that it can be launched using the standard “**NWRBrowser**” entry in



the AWIPS workstation applications menu. The overall look and feel of the NRRWAVES Browser is similar to the original NRRBrowser, however there are a number of new features and enhancements that are noted below.

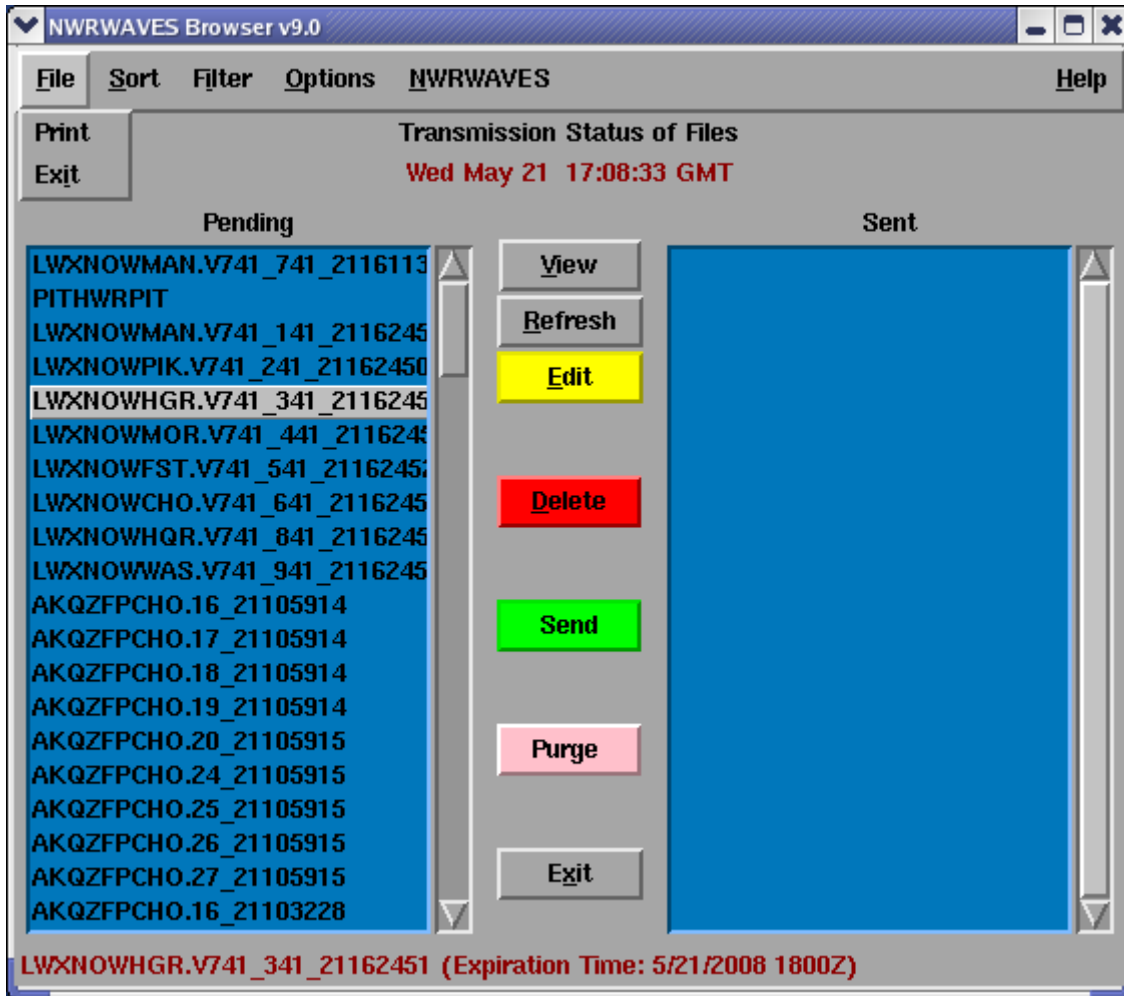

**Figure 9 – NRRWAVES Browser (front-end application to NRRWAVES)**

There are a series of pull-down menus across the top of the NRRWAVES interface:

- 1) **File** Menu (Keyboard Shortcut Alt-F)
  - a. Print – Print highlighted items from Pending/Sent lists (see Figure 9)
  - b. Exit – Used to close the browser
  
- 2) **Sort** Menu (Keyboard Shortcut Alt-S) – Because the number of items in the browser list boxes can become quite lengthy, a number of sorting capabilities were added to allow users to quickly locate outbound or transmitted CRS messages.
  - a. None – No sorting is done and the browser will function similar to the old NRR Browser.
  - b. Alphabetical (Default) – Files in the Pending and Sent list boxes will be sorted in alphabetical order.
  - c. Expiration Time – Files in the Pending and Sent list boxes will be sorted in the order in which CRS messages are scheduled to expire.

d. Applying the “**Decreasing Sort**” checkbox will sort the list boxes in either reverse alphabetical order (alphabetical sort applied) or in the reserve order in which CRS messages are scheduled to expire (Expiration Time sort).

- 3) **Filter Menu** (Keyboard Shortcut Alt-i) – The ability to filter items in the NWR Browser was added as another means to quickly located products in the Pending and Sent list boxes
- a. **Filter by Transmitter** – If you have configured your transmitters as in Section 1, you should see your list of transmitters present. Clicking any of the transmitter mnemonic radio buttons will cause the NWRWAVES browser to display only those outbound/transmitted products which are applicable to the selected transmitter.
  - b. **Filter by Product Type/WFO** – The NWRWAVES Browser filter function for products contains a vast list of the most widely used products. This list can be modified under the Summary Message/Miscellaneous Configuration Tab back in Section 3, Item 11. Clicking on any product type radio button will filter the display to only show those product types.

**NOTE:** The “output” item is used to filter the AWIPS climate program CRS messages

**NOTE:** You can apply a “combined” filter by selecting an item under both the Filter by Transmitter and Filter by Product Type menus.

- 4) **Options Menu** (Keyboard Shortcut Alt-O)
- a. **Clear Old Products** (and its equivalent **Purge** button on the main browser display) will allow a user to delete files whose CRS message expiration time has expired. The user will be prompted to remove products from both the Pending and Sent directories. This feature can be quite helpful in eliminating dead products from an extensive file listing, but be wary that there may be instances when a user may want to maintain an expired product for later retransmission.
  - b. **Update Expiration Time** – This option will become selectable once a user highlights a product in the Sent list box with the left mouse button. This feature allows a user to modify the expiration time of a product and retransmit it to CRS. This method is a great way to allow a forecaster/HMT to remove a product from the CRS broadcast cycle without having to physically remove it at the CRS console.
  - c. **Auto Refresh (Default On)** – This selection tells the NWRWAVES browser to auto update the Pending and Sent list boxes.
  - d. **Set Refresh Interval...** - The refresh interval can be changed from the default of 30 seconds by clicking on this menu item and entering a new number (in seconds) into the box.
  - e. **Highlight Warnings (Default On)** – This selection will cause the NWRWAVES browser list boxes to briefly change from a blue to a purple/pink background color when a short-fuse warning has been issued.

**NOTE:** Previous versions of NWRWAVES allowed sites to switch between three other LINUX editors available for use. After complications of sites using other editors and having corrupt CRS output, the baseline NWR Browser editor is now the only editor called by NWRWAVES.

- 5) **NWRWAVES Menu** (Keyboard Shortcut Alt-N)
- a. **NWRWAVES Setup** – Refer to Section 3 for launching the NWRWAVES Setup Utility. **This option is administratively restricted by AWIPS user accounts.** Most NWRWAVES users will not have access to the Setup Utility.

**NOTE:** You will only be allowed to open one version of the Setup GUI on your AWIPS at one time. This is controlled by a lock file which is created when the Setup GUI is launched, and is removed when you exit the Setup GUI.

If you get an error message that a version is already open somewhere else, but you are confident that there is not a version open anywhere on your AWIPS, perform the following steps:

- Open a shell on any AWIPS workstation as a user with 'fxalpha' group privileges.
- Type **cd /awips/adapt/NRWAVES**
- Type **rm -f setup.lock**
- Exit from the shell

- b. **View/Edit VTEC\_Summary File** – For offices using the summary message capabilities described in Section 3 – Tab 3 (page 17), users can manually edit/delete specific product summary messages should the automated VTEC replacement method fail. The pop-up GUI which appears when there are active hazards being track for summarization (Figure 10) is a simple interface. You select the hazard you which to modify from a list of buttons, and then you can either clear all LAC(s) at once or selected LAC(s) through their individual radio buttons. Sites will rarely (if ever) need to use this interface, since active hazards are tracked through VTEC action codes in follow-up statements. This will be a useful interface though, if you track a non-VTEC hazard such as an FFW in the interim period before full VTEC implementation.

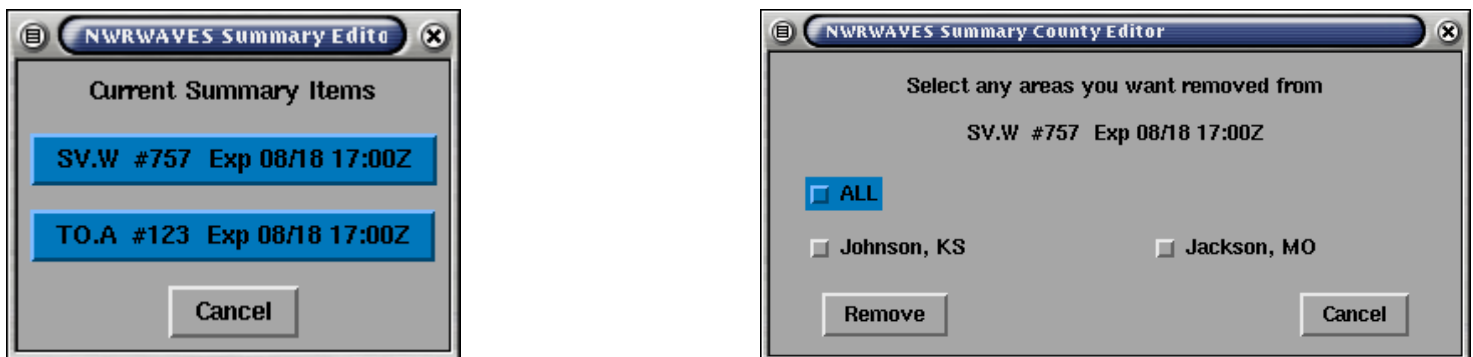

**Figure 10 – NNRWAVES summary message editing GUI interfaces**

- c. **Regenerate a CRS message** – Allows a user to call an AWIPS PIL from the text database and reprocess the product through the NNRWAVES formatter. When this option is selected, the user is prompted to enter an AWIPS product identifier then click 'OK'. The latest version of the product will appear in the 'Regenerate Product' GUI (Figure 11). Sites can toggle between database versions of the product type by using the "Previous Version" or "Latest Version" buttons. Once you have the product you wish to re-transmit in the viewer, click the "Send to NNRWAVES" button to re-process this product.

**NOTE:** If you use the "Include Issue Time" lead-in option for a product, the time that will be used is the time that the AWIPS product is processed by NNRWAVES, and not the time it was issued in its Mass Media header (MND date/time line). If you re-transmit a product, the time mentioned as the issuance time on the air will be the time you requested its retransmission.

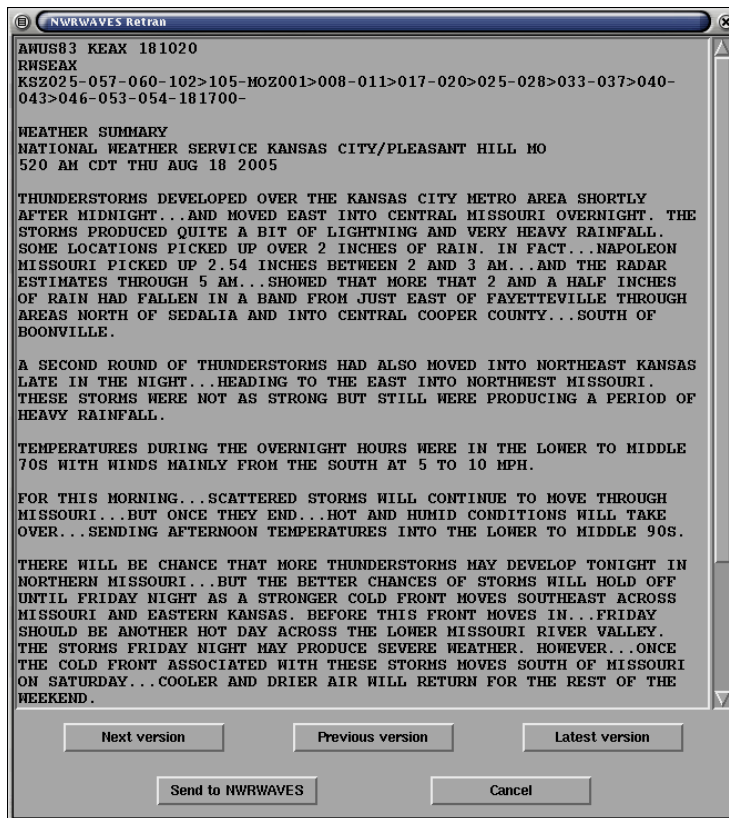

Figure 11 – NWRWAVES Retransmit product GUI interface

There are also a series of buttons down the middle of the interface. Some have been mentioned above, and there are a few additional buttons as well:

- d. **View button:** If a user left-clicks on a product (in either the 'Pending' or 'Sent' side of the NWRWAVES browser) and clicks this button, it will bring up the product in a viewer. This function is identical to the legacy NWRBrowser. Starting in version OB8.3, the user can also print the product in the viewer via the pull-down menus across the top left (under File->Print option).
- e. **Refresh button:** If clicked, it will force a manual auto-refresh of the NWRWAVES Browser.
- f. **Delete button:** If a user left-clicks on a product or products on either side of the browser and then clicks this button, these NWRWAVES products will be deleted from the browser. The user is prompted to confirm the delete (yes/no/yes to all). An improvement over the NWRBrowser is that a user can select multiple products at the same time.
- g. **Send button:** If a user left-clicks on a product or products on either side of the browser and clicks the 'Send' button, these product(s) will be sent to CRS. An improvement over the NWRBrowser is that a user can select multiple products at the same time.
- h. **Exit button:** This button exits the NWRWAVES Browser.

## 8. NWRWAVES PROGRAM EXECUTION (LOGGING, TROUBLESHOOTING)

NWRWAVES is called through the use of AWIPS text database triggers. You can call for NWRWAVES to run manually two different ways: you can 'Regenerate a CRS Message' or edit the summary message. Both of these methods are detailed above.

Here is a breakdown of the execution of NWRWAVES for the receipt of a product:

- 1) An inbound product is received into the AWIPS database.
- 2) A text database trigger is executed to initiate NWRWAVES for the inbound AWIPS product. Depending on your settings in your siteTrigger.template file, you will either call the c-shell script that runs NWRWAVES in TEST mode (/awips/adapt/NWRWAVES/nwrwavestest.csh) or the c-shell script that runs NWRWAVES in operational mode (/awips/adapt/NWRWAVES/nwrwaves.csh).
- 3) These c-shell scripts perform the following functions:
  - a) The script takes the inbound product and 'cleans' it up for use.
  - b) The inbound product is moved from /data/fxa/trigger to the /awips/adapt/NWRWAVES/QUEUE directory for processing.
  - c) A check is performed to ensure that only one version of NWRWAVES is running. If one is currently active, this iteration will sleep for 30 seconds before checking again. If the same version is still running after 30 seconds, these scripts will assume a hung process, kill the original one so that this one can begin. Thorough testing has indicated that a time period much less than 30 seconds is all that NWRWAVES requires for proper execution.
  - d) These scripts perform a 'checksum' on the main program (nwrwaves.tcl) and write this checksum to the product's debug file.

**NOTE:** The 'checksum' value is a fixed value of the nwrwaves.tcl code as prepared and released into AWIPS baseline software. If your site has trouble with NWRWAVES, support staff will ask for this value. If it is anything other than the baseline value, it is an indication that someone at your site has made edits to the baseline software. **SITES WILL NOT MAKE ANY LOCAL CHANGES TO THE NWRWAVES SCRIPTS AS DELIVERED!!** Making local changes to the baseline software may introduce unintended instability to the program, and it will be impossible to troubleshoot your problem if you have made local changes. Off-site troubleshooting will likely be denied until you restore the baseline version of 'nwrwaves.tcl', and the debug log file reflects the same 'checksum' value as the baseline value.

**NOTE:** An extensive debug and operational logging scheme is used in NWRWAVES, to assist in local and off-site troubleshooting. This scheme is detailed in (5) below.

- e) These scripts call the main formatter program 'nwrwaves.tcl'. The 'TEST' argument is the only difference between the two c-shell scripts. The AWIPS PID (file name) of the product being processed is also passed as an argument.
- 4) The main file 'nwrwaves.tcl' is executed next. All processing related to product preparation, assembling and formatting is performed by this script. This script does utilize three additional scripts

at different points during message preparation and assembly. These are located in the /awips/adapt/NWRWAVES/bin directory and are as follows:

- a) **UGC\_VTEC\_Decoder.tcl:** This module is called by nwrwaves.tcl to decode the UGC and VTEC lines (as appropriate) from an inbound AWIPS product. If there is no UGC (UGZ) line in the inbound product (such as an RER), then this module will assign the product a ‘dummy list’ which is one county from each transmitter. NWRWAVES will use the first county (alphabetically) from each transmitter. There is no way to control a non-UGC (UGZ) coded product by transmitter. Every transmitter will receive a copy of the product, with an assigned default expiration time of 360 minutes.
- b) **UGCLookup.table:** This is the master baseline lookup table for all counties/parishes/independent cities and zones/fire weather zones/marine zones. Sites will not modify this file! If an area is missing, you do have the ability to add it manually through the Transmitter Configuration GUI (Section 3 – Tab 1: Page 7). Any local LAC’s added will be placed in the file localUGCLookup.table in this same /bin directory. NWRWAVES will source both lookup tables (if applicable) when it searches for UGC/UGZ codes.

**NOTE:** If you do find missing counties/zones that should be in the baseline file, please post them to the NWRWAVES list server (Section 7) to ensure they do get added in a future build release of NWRWAVES.

- c) **WordFile.txt:** This file is a legacy from CAFÉ, and you can add words, phrases or wild card entries. NWRWAVES will make substitutions from the AWIPS product to the outbound CRS products as needed. The WordFile.txt file is detailed below.
  - d) **WordFile\_SPN.txt:** This optional file operations exactly in the same manner as the WordFile.txt above, but allows offices that broadcast separate Spanish products to develop a separate word/phrase replace file for Spanish phrases.
- 5) **Debugging and logging information:** NWRWAVES makes extensive use of logging to assist in troubleshooting. Unless mentioned specifically, the files below are placed in the directory listed which can be found under the root NWRWAVES directory (/awips/adapt/NWRWAVES).

Here is a breakdown of available resources to you:

- a) **INPUT directory:** NWRWAVES will archive every AWIPS product that is sent through NWRWAVES. The product will be named with the 8-9 letter AWIPS Product Identifier, followed by the date/time stamp of the product when it was processed. This date/time stamp will match the stamp assigned to its associated ‘debug’ and ‘output’ files, so that you have the input and output that can be easily matched, along with additional debug information.
- b) **OUTPUT directory:** Similar to (a) above, but this directory contains all the output (CRS Weather Messages) prepared by NWRWAVES from the files stored in the INPUT directory.

- c) LOGS directory: NWRWAVES keeps a daily log of all its activity. These log files are named using this scheme: [nwrwaves.mmddy.log](#). These daily logs will track the major processing points of NWRWAVES for every product processed on that day. The ‘checksum’ value is also written here.
- d) DEBUG directory: NWRWAVES will create a unique ‘debug’ file for each product processed in this directory. The debug file naming scheme is: [CCCNNNXXX\\_yymmddhhmmssdebug.txt](#) where the CCCNNNXXX is the inbound AWIPS product identifier. You will be able to match this file with its corresponding entries in the INPUT and OUTPUT directories. The debug file contains a log of the major and minor processing points of NWRWAVES execution for this particular product.
- e) SUMMARY directory: Any summary messages generated by NWRWAVES are kept in this directory.
- f) ERROR directory: If NWRWAVES crashes for any reason, the core dump of the tcl/tk interpreter, along with a copy of the inbound AWIPS product are placed in this directory. There is also a file kept in the /awips/adapt/NWRWAVES directory called ‘errorout.txt’. This file will exist, and its size will be zero, if NWRWAVES has run successfully for any product.

**NOTE:** The contents of these directories are scoured by an automated cron at the intervals established under Section 3, item 12 of this document under the Summary Message/Miscellaneous Configuration settings. These files contain activity logs of everything sent into, and that comes out of, NWRWAVES.

**NOTE:** NWRWAVES has robust error trapping capabilities built into the software. Should NWRWAVES fail, the operational staff will be alerted by a red-banner message (fxaAnnounce and **sendNotificationMsg** in **AWIPS II release 15.1.1 on**) that the program failed, and they will be directed as to why it failed. Please see Appendix-I for setting up the banner in AWIPS II. Examples of some common failure conditions include: expired UGC time in a product, corrupt product configuration file (hand editing), and corrupt VTEC or UGC lines (hand editing). If a product fails to transmit, sites will at least be able to recognize what didn’t process, then take appropriate action to ensure that the data is broadcast.

- 6) When ‘nwrwaves.tcl’ has finished, it will take appropriate action with its output file(s) for CRS. If you called this file with the ‘nwrwavestest.csh’ file, all output files will be copied to the /awips/adapt/NWRWAVES/TEST directory. If you used the ‘nwrwaves.csh’ file, then the output will be copied to one of two locations:
  - a) If your transmission status is set to “CRS” for this NWRWAVES product type, the output will be copied to the ‘/data/fxa/workFiles/nwr/ready’ directory. Baseline AWIPS processes that monitor this directory will then take the output files and send them to CRS.
  - b) If your transmission status is set to “Pending” for this NWRWAVES product type, the output will be copied to the ‘/data/fxa/workFiles/nwr/pending’ directory. They will appear in the ‘Pending’ side of the NWRWAVES Browser. Manual intervention through the browser will be required to send the output to CRS.

A complete listing of the NWRWAVES file structure is included in Appendix A.

## 9. WORD/PHRASE REPLACEMENT CAPABILITY

The use of the Voice Improvement Processor (VIP) pre-processor and dictionary capabilities is encouraged to handle most word replacements, but there are some instances where you may want to make corrections before a product is transmitted to CRS. A number of such features are already built into NWRWAVES, including the correction of punctuation, removal of ellipses, etc. However a **WordFile(\_SPN).txt** file is provided with NWRWAVES. Instructions are provided at the top of this file, along with a number of examples within. There are two word replacement files: **WordFile.txt** (used for all but inbound AWIPS products that end in “SPN”), and **WordFile\_SPN.txt** (used for Spanish inbound products that have an AWIPS PID that ends in “SPN”).

To modify the word replacement file:

- 1) Open a shell on any AWIPS workstation, with a user account that has ‘fxalpha’ group privileges.
- 2) Type **cd /awips/adapt/NWRWAVES/bin.**
- 3) Type **gedit /awips/adapt/NWRWAVES/bin/WordFile.txt.**
- 4) Add any words or phrases that you want in the prescribed format.
- 5) **Save** and **exit** from the editor when you are done
- 6) Close the active shell.

Some hints and guidelines as to the structure of this file (**NOTE: It is similar to the CAFÉ WordFile.txt file. You should be able to easily port any local changes you have made there into NWRWAVES**):

- a) Use a double pipe (||) to separate the original string from the replacement string.
- b) All white space will be ignored.
- c) Do not use punctuation in the original phrase. NWRWAVES will automatically replace the original phrase even if it is followed by a comma, period, dash, new line or space.
- d) Phone numbers do not require any special entries for replacement, if they are included in your AWIPS text products in a traditional phone number format #-###-#### or ###-###-####. These formats will be handled correctly in NWRWAVES. If a site formats phone numbers differently in their actual text products, it may not be necessary to do so anymore, as they might get unexpected results.
- e) Related to (d), sites that typically use ranges with a dash (NORTH WINDS 7-11 MPH, HIGHS 77-82) will not get correct wording in an outbound CRS product. These ranges will need to be coded up differently in AWIPS text products.
- f) For advanced users, the use of regular expressions is allowed and encouraged. Do not surround any regular expressions with quotes or braces { }.

An excellent reference to how regular expressions can be crafted can be found in the black Tcl/Tk Welch Book, "Practical Programming in Tcl and Tk". Pages 121-126 are most insightful. Examples of some common regular expressions are:

**[0-9][0-9][0-9][0-9]Z ||**



Replaces UGC time references in products such as ‘1200Z’

**[HPMCEA][DS]T ||**

For time zone replacement, you can use this regular expression to take out time zone references in a product. In the baseline WordFile.txt, this line is commented out. Uncomment the line (take out the leading # symbol) if you want to filter out all time zones. If your office has multiple time zones, you may want to modify this to take out the most common one (i.e., take out C in the first bracketed area to mention Central Daylight/Standard Time but mention Mountain Time.

**SEE LAKE ONTARIO OPEN LAKES FORECAST FOR [^/n]+ ||**

This is an example of how to code up a replacement for a common phrase, where wording may vary at the end such as the end of the week. The following phrase might be commonly found in a Near Shore Forecast: SEE LAKE ONTARIO OPEN LAKES FORECAST FOR FRIDAY THROUGH THURSDAY.

- g) Do not duplicate entries here with those that already exist in your VIP dictionary. This file is ideal for overriding CRS generalities such as:
- FT to be read as FEET
  - Stripping the time zones off of time stamps in products (see (d) above)
  - Pausing long phrases

## 10. SWAPS Capability

SWAPS capability is another level of word replacement within the lead-in’s for different NWRWAVES products. This feature allows the forecasters to substitute/replace the wordings for 2 or more or a group of counties by a simple phrase. See example in the `localSWAPS.txt` of how to use the SWAPS option.

## 11. OPTIONS TO PARSE CALL-TO-ACTION IN NWS ALERT MESSAGES

In OB9 release, AWIPS warning generation tools such as WarnGen, GFE/GHG, and RiverPro will add a pair of unique markers between the Call-To-Action (CTA) Statements in many of the text products (see Appendix-E). It is part of the capabilities specified in OSIP #07-024 project - Formatting NWS Alert Messages in CAP. The current proposed solution for the CTA markers is:

**(blank line)**

**PRECAUTIONARY/PREPAREDNESS ACTIONS...**

**(blank line)**

**(single- or multi-line text content of call-to-action, instructions, etc. here)**

**(blank line)**

**&&**

**(blank line)**

In OB9 release, AWIPS warning generation tools such as WarnGen, GFE/GHG, and RiverPro will add a pair of unique markers between the Call-To-Action (CTA) Statements in many of the text products (see Appendix-E). It is part of the capabilities specified in OSIP #07-024 project - Formatting NWS Alert Messages in CAP. The current proposed solution for the CTA markers is:

For the NWR purpose, NWRWAVES will remove the markers. Also, based on the particular hazard, NWRWAVES will provide the WFOs the option to either broadcast the corresponding CTAs or not (i.e., turn on/off the broadcast of the CTAs). In AWIPS OB8.3 release, an experimental option was added in the NWRWAVES GUI to allow the WFOs to turn on/off the CTAs for all the Marine Weather Warnings (MWW) products. The option applied globally for all the MWW products but not the individual VTEC phenomena/significance. In OB9 release, this MWW CTA GUI selection has been removed and a site-level (non-GUI base) configuration file would be used to control the CTA statements.

In OB9, all CTAs will NOT be removed by default unless the WFO NWRWAVES focal point would enter an entry or entries of configuration data in a newly created ASCII configuration file /awips/adapt/NWRWAVES/bin/NO\_CTA.ini. The only way to filter out the CTA is to enter both the Product Type AND the corresponding VTEC entry or a VTEC entry with action codes separate by a comma.

The following is an example of the CTA configuration file:

```
#####
#### NWRWAVES Call-To-Action related config FILE: NO_CTA.ini ###
####
#### By default, all the CTA statements will be part of      ###
#### the warning products. The only way to remove the CTA   ###
#### statements is by creating the following entries:        ###
####
#### (1) Product type e.g. NPW AND (2) either a VTEC event  ###
#### code e.g. TO.W (apply for all action codes)           ###
#### or a VTEC phenomena/significance plus action codes     ###
#### separate by a comma.                                   ###
####
#### The following are two examples of removing the CTA     ###
#### statements associate with wind advisory and Lake wind  ###
#### in the NPW product type:                                ###
#### NPW   ###
#### WI.Y  ###
#### LW.Y,NEW,CON   ###
####
#### These three entries combination will instruct the      ###
#### NWRWAVES to remove the CTA statements from the NPW    ###
#### product output.  ###
#### In the case of mutiple VTECs within a given segment,  ###
#### one or more VTEC(s) is not specified in this file,   ###
#### all the CTA statements will be output automatically for ###
#### that particular segment.                                ###
####
#### There are 2 exceptions that user can turn off the OVR  ###
#### overview products without CTA by entering the following ###
#### entry(ies):   ###
#### FLWOVR  ###
#### FLSOVR   ###
#### The FLW or FLS (hydro) products are the only two with ###
#### the CTA in the overview section being removed from the ###
```

```

#### OVR product.                                     ###
#####
#
# Base on product type and VTEC phenomena/significance e.g. NPW and WI.
NPW
WI.Y

# Base on product type and VTEC phenomena/significances plus selected actions
MWW
SC.Y,CON,EXA

**EndOfFile**

```

To completely remove all the CTAs for the VTEC phenomena/significance such as "SV.W" for example, the user needs to enter two product types (e.g. SVR and SVS) in the configuration file-

```

SVR
SVS
SV.W,NEW,CON,EXP,CAN

```

or

```

SVR
SV.W,NEW
SVS
SV.W,CON,EXP,CAN

```

Say if the user removes the "SVR" line from the configuration file:

```

SVS
SV.W,NEW,CON,EXP,CAN

```

Then, the CTA associates with the action code of "NEW" will never be removed from the output since only the "SVR" products can have the "NEW" action. Or specifically, NWRWAVES skips the code to process CTA since the product type "SVR" is not specified in the configuration file.

When there are multiple VTEC events described within the same product or product segment, there may be more than one CTA. If one or more of the VTEC events are not specified in the CTA configuration file in a given product or product segment, then the entire CTA section between the CTA markers shall be broadcast. In other words, more than one CTA may be broadcast. If only the start CTA marker exists in a product without the end CTA marker (&&), NWRWAVES would broadcast the text that follows the start CTA marker regardless of any WFO-level CTA option configuration.

## 12. LESSONS LEARNED AND RESOURCES AVAILABLE

An NWRWAVES resource web site has been created for support purposes. This site is located under the CRS web site maintained by NWS Headquarters (<http://www.weather.gov/ops2/crs/nwrwaves.htm>). This web site contains an FAQ list, various documentation for NWRWAVES, and a link to the NWRWAVES listserver.

NWRWAVES support is administered through the NCF. Sites experiencing difficulties with NWRWAVES should call the NCF and open a trouble ticket. The NCF will provide Tier 1 support for offices using NWRWAVES. If the NCF believes that Tier 2 support is necessary, they will contact the appropriate Tier 2 support group. **Tier 2 support is now the CRS Operations Group at NWSHQ.**

General support questions can and should be referred to the NWRWAVES Listserver. If you're in need of general support or just have a question regarding NWRWAVES (no imminent problem or NCF support needed for a failure), the best mechanism for support is as follows:

- a. If the problem you're experiencing is impacting operational use, contact the NCF and open a trouble ticket.
- b. If it is not an imminent issue, check your question against the FAQ list on the NWRWAVES web site. If your question has been encountered before, you will find the solution posted here.
- c. If the question is not readily visible on the FAQ list, post it to the list server. This way, everyone who has been working with the software can see your situation, and you can get help from other NWRWAVES users. Operational questions, configuration issues and questions should be submitted to the NWRWAVES list server to ensure the quickest response possible.

To sign up for the NWRWAVES list server, go to the following URL: <http://infolist.nws.noaa.gov/read/login/> Input your e-mail address and e-mail password, then select the All Forums Tab. Scroll down to NWRWAVES and click on subscribe. You will receive information back from the listserv concerning use of the forum

# APPENDIX A – COMPLETE NWRWAVES FILE LISTING

## MAIN INSTALL DIRECTORY LISTING

```

drwxrwxrwx    2 fxa    fxalpha    28672 Apr 27 16:47 BACKUP
drwxrwxrwx    2 fxa    fxalpha     4096 Apr 23 11:29 bin
drwxrwxrwx    2 fxa    fxalpha     4096 Apr 24 13:35 browser
drwxrwxrwx    2 fxa    fxalpha   139264 Apr 28 21:14 DEBUG
drwxrwxrwx    2 fxa    fxalpha     4096 Apr 15 22:10 ERROR
-rw-rw-r--    1 fxa    fxalpha         0 Apr 28 21:14 errorout.txt
-rw-rw-r--    1 fxa    fxalpha         37 Apr 28 21:14 FILENAME.LAST
drwxrwxrwx    2 fxa    fxalpha   73728 Apr 28 21:14 INPUT
drwxrwxrwx    2 fxa    fxalpha     4096 Apr 28 01:40 LOGS
-rw-rw-rw-    1 fxa    fxalpha         18 Apr  5 19:49 NONVTECMRD.txt
-rwxrwxr-x    1 fxa    fxalpha     4265 Apr  9 17:47 nwrwaves.csh
-rwxrwxrwx    1 fxa    fxalpha     1026 Feb 23 18:48 NWRWAVESpurge.sh
-rw-rw-r--    1 fxa    fxalpha         4 Apr  2 16:22 NWRWAVES_RELEASE_ID
-rwxrwxr-x    1 fxa    fxalpha   212320 Mar 24 23:45 nwrwaves_setup.tcl
-rwxrwxr-x    1 fxa    fxalpha   160858 Apr  9 18:10 nwrwaves.tcl
-rwxrwxr-x    1 fxa    fxalpha     4270 Apr  9 18:21 nwrwavestest.csh
drwxrwxrwx    2 fxa    fxalpha   49152 Apr 28 21:14 OUTPUT
-rwxrwxrwx    1 fxa    fxalpha         788 Feb 18 15:16 pendingDirCheck
-rw-rw-r--    1 fxa    fxalpha   14738 Apr 26 19:37 product.cfg
-rw-rw-r--    1 fxa    fxalpha   14375 Apr  2 16:22 product.cfg.V2.4
-rw-rw-rw-    1 fxa    fxalpha         15 Apr 27 17:01 purge.cfg
drwxrwxrwx    2 fxa    fxalpha     4096 Apr 28 21:14 QUEUE
-rwxrwxrwx    1 fxa    fxalpha     1467 Feb 23 18:48 removeExpiredNWR.sh
drwxrwxrwx    2 fxa    fxalpha     4096 Apr 16 01:21 SUMMARY
drwxrwxrwx    2 fxa    fxalpha     4096 Mar 24 16:32 TEST
-rw-rw-rw-    1 fxa    fxalpha     4704 Mar 25 00:03 UGClookup_changes.txt
-rwxrwxr-x    1 fxa    fxalpha     2941 Feb 18 15:17 updateSUMMARY.csh

```

## NWRWAVES bin DIRECTORY LISTING

```

-rwxrwxr-x    1 fxa    fxalpha     9039 Feb 18 15:17 clocktime.tcl
-rwxrwxr-x    1 fxa    fxalpha    15098 Feb 18 15:17 color_msgbox.tcl
-rwxrwxr-x    1 fxa    fxalpha    64430 Feb 18 15:17 combobox.tcl
-rwxrwxr-x    1 fxa    fxalpha     2211 Feb 18 15:17 dialog.tcl
-rw-rw-rw-    1 fxa    fxalpha         44 Dec  2 08:52 localUGClookup.table
-rwxrwxr-x    1 fxa    fxalpha     5104 Feb 18 15:17 notebook.tcl
-rwxrwxr-x    1 fxa    fxalpha         923 Feb 18 15:17 pkgIndex.tcl
-rwxrwxrwx    1 fxa    fxalpha     1545 Feb 18 15:17 relinkNWRWAVESBrowser.sh
-rw-rw-rw-    1 fxa    fxalpha   230042 Mar 25 00:06 UGClookup.table
-rwxrwxr-x    1 fxa    fxalpha    27118 Mar 14 16:51 UGC_VTEC_Decoder.tcl
-rw-rw-rw-    1 fxa    fxalpha         751 Feb 18 15:17 VTECrank.ini
-rw-rw-rw-    1 fxa    fxalpha     1715 Feb 15 19:32 WordFile_SPN.txt
-rwxrwxrwx    1 fxa    fxalpha     3315 Jan 24 19:47 WordFile.txt
-rw-rw-rw-    1 fxa    fxalpha         717 DEC 13 13:01 localSWAPS.txt
-rw-rw-rw-    1 fxa    fxalpha         717 Apr 13 13:01 NO_CTA.ini
-rw-rw-rw-    1 fxa    fxalpha         717 Apr 13 13:01 NWEM.cfg

```

NWRWAVES BROWSER DIRECTORY LISTING

-rw-r--r--	1	fxa	fxalpha	57	Apr	24	13:33	admin.list
-rw-rw-rw-	1	fxa	fxalpha	1118	Mar	24	22:36	browser.cfg
-rw-rw-rw-	1	fxa	fxalpha	267	Mar	24	22:36	browser.ini
-rwxrwxr-x	1	fxa	fxalpha	66988	Mar	24	23:42	browser.tcl
-rw-rw-rw-	1	fxa	fxalpha	5	Apr	27	17:01	pending.cfg
-rw-rw-rw-	1	fxa	fxalpha	95	Apr	27	17:01	pils.list
-rwxrwxr-x	1	fxa	fxalpha	12788	Mar	24	22:36	update.tcl

## APPENDIX B – EXAMPLE OF EAX siteTrigger.template FILE FOR NWRWAVES

```
STLSVREAX /awips/adapt/NWRWAVES/nwrwaves.csh
STLSVRLSX /awips/adapt/NWRWAVES/nwrwaves.csh
STLSVRSGF /awips/adapt/NWRWAVES/nwrwaves.csh
TOPSVRTOP /awips/adapt/NWRWAVES/nwrwaves.csh
DSMSVRDMX /awips/adapt/NWRWAVES/nwrwaves.csh
CHISVRDVN /awips/adapt/NWRWAVES/nwrwaves.csh
OMASVROAX /awips/adapt/NWRWAVES/nwrwaves.csh
STLTORLX /awips/adapt/NWRWAVES/nwrwaves.csh
STLTORLSX /awips/adapt/NWRWAVES/nwrwaves.csh
STLTORSGF /awips/adapt/NWRWAVES/nwrwaves.csh
TOPTORTOP /awips/adapt/NWRWAVES/nwrwaves.csh
DSMTORDMX /awips/adapt/NWRWAVES/nwrwaves.csh
CHITORDVN /awips/adapt/NWRWAVES/nwrwaves.csh
OMATOROAX /awips/adapt/NWRWAVES/nwrwaves.csh
STLFFWEAX /awips/adapt/NWRWAVES/nwrwaves.csh
STLFFWLSX /awips/adapt/NWRWAVES/nwrwaves.csh
STLFFWSGF /awips/adapt/NWRWAVES/nwrwaves.csh
TOPFFWTOP /awips/adapt/NWRWAVES/nwrwaves.csh
DSMFFWDMX /awips/adapt/NWRWAVES/nwrwaves.csh
CHIFFWDVN /awips/adapt/NWRWAVES/nwrwaves.csh
OMAFFWOAX /awips/adapt/NWRWAVES/nwrwaves.csh
STLFFAEAX /awips/adapt/NWRWAVES/nwrwaves.csh
STLFFALSX /awips/adapt/NWRWAVES/nwrwaves.csh
STLFFASGF /awips/adapt/NWRWAVES/nwrwaves.csh
TOPFFATOP /awips/adapt/NWRWAVES/nwrwaves.csh
DSMFFADMX /awips/adapt/NWRWAVES/nwrwaves.csh
CHIFFADVN /awips/adapt/NWRWAVES/nwrwaves.csh
OMAFFAOAX /awips/adapt/NWRWAVES/nwrwaves.csh
STLFFSEAX /awips/adapt/NWRWAVES/nwrwaves.csh
STLFFSLSX /awips/adapt/NWRWAVES/nwrwaves.csh
STLFFSSGF /awips/adapt/NWRWAVES/nwrwaves.csh
CHIFFSDVN /awips/adapt/NWRWAVES/nwrwaves.csh
DSMFFSDMX /awips/adapt/NWRWAVES/nwrwaves.csh
TOPFFSTOP /awips/adapt/NWRWAVES/nwrwaves.csh
OMAFFSOAX /awips/adapt/NWRWAVES/nwrwaves.csh
STLFLWEAX /awips/adapt/NWRWAVES/nwrwaves.csh
STLFLWLSX /awips/adapt/NWRWAVES/nwrwaves.csh
STLFLWSGF /awips/adapt/NWRWAVES/nwrwaves.csh
CHIFLWDVN /awips/adapt/NWRWAVES/nwrwaves.csh
TOPFLWTOP /awips/adapt/NWRWAVES/nwrwaves.csh
OMAFWLOAX /awips/adapt/NWRWAVES/nwrwaves.csh
STLFLSEAX /awips/adapt/NWRWAVES/nwrwaves.csh
STLFLSLSX /awips/adapt/NWRWAVES/nwrwaves.csh
STLFLSSGF /awips/adapt/NWRWAVES/nwrwaves.csh
CHIFLSDVN /awips/adapt/NWRWAVES/nwrwaves.csh
TOPFLSTOP /awips/adapt/NWRWAVES/nwrwaves.csh
OMAFLSOAX /awips/adapt/NWRWAVES/nwrwaves.csh
STLWSWEAX /awips/adapt/NWRWAVES/nwrwaves.csh
STLWSWLSX /awips/adapt/NWRWAVES/nwrwaves.csh
TOPWSWTOP /awips/adapt/NWRWAVES/nwrwaves.csh
OMAWSWOAX /awips/adapt/NWRWAVES/nwrwaves.csh
```

CHIWSWDVN /awips/adapt/NWRWAVES/nwrwaves.csh  
DSMWSWDMX /awips/adapt/NWRWAVES/nwrwaves.csh  
STLWSWSGF /awips/adapt/NWRWAVES/nwrwaves.csh  
STLNOWEAX /awips/adapt/NWRWAVES/nwrwaves.csh  
STLNOWLSX /awips/adapt/NWRWAVES/nwrwaves.csh  
STLNOWSGF /awips/adapt/NWRWAVES/nwrwaves.csh  
CHINOWDVN /awips/adapt/NWRWAVES/nwrwaves.csh  
DSMNOWDMX /awips/adapt/NWRWAVES/nwrwaves.csh  
TOPNOWTOP /awips/adapt/NWRWAVES/nwrwaves.csh  
OMANOWOAX /awips/adapt/NWRWAVES/nwrwaves.csh  
STLNPWEAX /awips/adapt/NWRWAVES/nwrwaves.csh  
STLNPWLSX /awips/adapt/NWRWAVES/nwrwaves.csh  
CHINPWDVN /awips/adapt/NWRWAVES/nwrwaves.csh  
DSMNPWDMX /awips/adapt/NWRWAVES/nwrwaves.csh  
OMANPWOAX /awips/adapt/NWRWAVES/nwrwaves.csh  
TOPNPWTOP /awips/adapt/NWRWAVES/nwrwaves.csh  
STLNPWSGF /awips/adapt/NWRWAVES/nwrwaves.csh  
STLNPSEAX /awips/adapt/NWRWAVES/nwrwaves.csh  
STLHWOEAX /awips/adapt/NWRWAVES/nwrwaves.csh  
STLSPSEAX /awips/adapt/NWRWAVES/nwrwaves.csh  
STLRWSEAX /awips/adapt/NWRWAVES/nwrwaves.csh



## APPENDIX C – NWRWAVES Cron Jobs

NWRWAVES has four background cron jobs. All the cron jobs run on dx2 as user fxa, except during a failover when they will run on dx1. The cron jobs are listed below:

```
# Crontab file for starting dx2apps NWRWAVES purge processes.

# Any entry that needs to use ${FXA_HOME} or ${FXA_DATA} should use "csh -c"
# to run the command. The command and any output redirection to a file must
# all be include in single quotes after the "-c". The output redirection
# will then be done by the csh so it must use csh syntax.

# PURGER/SCOUR...
# Run NWRWAVESpurge.sh daily to clean DEBUG LOGS OUTPUT INPUT
# and TEST Directories
45 0 * * * csh -c '/awips/adapt/NWRWAVES/NWRWAVESpurge.sh >& /dev/null'

# Run removeExpiredNWR.sh twice an hour to remove any expired or
# corrupt files from pending and sent side of NWRWAVESBrowser
20,40 * * * * csh -c '/awips/adapt/NWRWAVES/removeExpiredNWR.sh >& /dev/null'

# OTHER NWRWAVES Cron jobs
# Summary Update Script, updateSUMMARY.csh, four times an hour to
# update the summary message
00,15,30,45 * * * * csh -c '/awips/adapt/NWRWAVES/updateSUMMARY.csh >& /dev/null'

# Run the Pending Directory Check Script, pendingDirCheck, every ten minutes
# to check for old messages in the pending directory
00,10,20,30,40,50 * * * * csh -c '/awips/adapt/NWRWAVES/pendingDirCheck >& /dev/null'
```

***NWRWAVESpurge.sh*** – Runs once a day 00:45Z. It purges files in the DEBUG, LOGS, INPUT, OUTPUT and TEST directories. Purge settings are contained in the file /awips/adapt/NWRWAVES/purge.cfg and are modified by using the NWRWAVES Setup GUI.

***removeExpiredNWR.sh*** – Runs twice an hour at 20 and 40 minutes past. It removed expired and corrupt messages from the /data/fxa/workFiles/nwr/pending and /data/fxa/workFiles/nwr/sent directories.

***updateSUMMARY.csh*** – Runs four times an hour at 00, 15, 30, and 45 minutes past. It forces an update of any active NWRWAVES Summary messages.

***pendingDirCheck*** – Runs six times an hour at 00, 10, 20, 30, 40, and 50 minutes past. It checks for stale messages in the /data/fxa/workFiles/nwr/pending directory. If a stale message is detected, then an fxaAnnounce Red Banner message is sent. The time a messages needs to sit in the pending directory before it is considered stale is configured in the NWRWAVES Setup GUI. This script can also be disabled in the NWRWAVES Setup GUI.

## APPENDIX D – Instructions for implementing MWW Watch/Warnings/Advisories

The following is a list of the applicable Watches, Warnings and Advisories that can be issued with the Marine Weather product (MWW) along with the associated V-TEC code, Issuance and Followup headers.

<b>Marine Watches</b>			
<b>Products</b>	<b>VTEC</b>	<b>Issuance Header</b>	<b>Followup Header</b>
Hurricane Force Wind Watch	HF.A	MWW	MWW
Storm Watch	SR.A	MWW	MWW
Gale Watch	GL.A	MWW	MWW
Hazardous Seas Watch	SE.A	MWW	MWW
Heavy Freezing Spray Watch	UP.A	MWW	MWW

<b>Marine Warnings</b>			
<b>Products</b>	<b>VTEC</b>	<b>Issuance Header</b>	<b>Followup Header</b>
Hurricane Force Wind Warning	HF.W	HUW	HUW
Storm Warning	SR.W	MWW	MWW
Gale Warning	GL.W	MWW	MWW
Hazardous Seas Warning	SE.W	MWW	MWW
Heavy Freezing Spray Warning	UP.W	MWW	MWW

<b>Marine Advisories</b>			
<b>Products</b>	<b>VTEC</b>	<b>Issuance Header</b>	<b>Followup Header</b>
Ashfall Advisory	AF.Y	NPW	NPW
Brisk Wind Advisory	BW.Y	MWW	MWW
Dense Fog Advisory	FG.Y	NPW	NPW
Dense Smoke Advisory	SM.Y	NPW	NPW
Freezing Spray Advisory	UP.Y	MWW	MWW
Low Water Advisory	LO.Y	MWW	MWW
Small Craft Advisory	SC.Y	MWW	MWW
Small Craft Advisory for Hazardous Seas	SW.Y	MWW	MWW
Small Craft Advisory for Rough Bar	RB.Y	MWW	MWW
Small Craft Advisory for Winds	SI.Y	MWW	MWW

Each of the marine sites will have to configure the MWW entries according to their needs. The following is an example of how to configure an MWW for Small Craft Advisory (SC.Y).

## Instructions for implementing Small Craft Advisory (SC.Y) NRRWAVES (OB8.2 and older)

There are two basic steps needed to implement SC.Y products into NRRWAVES. The first is to create the product and configure it within NRRWAVES, and the second is to create the textdb trigger for the new MWW AWIPS product.

### 1. Create the SC.Y product within NRRWAVES

- From the NRRBrowser on AWIPS, launch the NRRWAVES Setup GUI.
- Click on the second tab, which is labeled "NRRWAVES Product Configuration" (below).

The screenshot shows the 'NRRWAVES Setup Utility' window with the 'Product Configuration' tab selected. The window has a menu bar with 'File' and 'Help'. Below the menu bar are four tabs: 'Transmitter Configuration', 'Product Configuration' (selected), 'Summary Message/Misc Settings', and 'Marine/Tropical Product Configuration'. A toolbar contains 'Select A Hazard Below', 'Sort By: VTEC', 'Product', 'Issuance Header', 'Followup Header', and a pink 'Add Product' button. Below the toolbar is a red bar with a dropdown menu, a text input field, and a green 'Save/Update' button with a help icon. The main area is divided into two panels: 'Message Properties' and 'Transmission Properties'. The 'Message Properties' panel includes options for 'Process as Generic Message Type?', 'Use MRD Replace on CRS?', 'Process ONLY for Core County/Zone?', 'Process for Non-Routine Broadcast Service Area(s)?', 'Intro:', 'Include Preamble?', 'Include County/Zone List?', 'Include Issue Time?', 'Include Headlines?', 'Generate Overview Product?', 'Include Supplemental Text?', 'Repeat Headline?', and 'In Summary Message?'. The 'Transmission Properties' panel includes 'Select Broadcast Area:', 'Interrupt Status:', 'Alert Tones:', 'COR:', 'CAN:', 'CON:', 'EXA:', 'EXT:', 'EXB:', 'EXP:', 'Silence Period', 'Storage:', 'Transmission Status:', 'Periodicity:', 'CRS Effective Time:', 'Default Duration:', and 'Use if UGC expiration missing'.

- Click the pink 'Add Product' button.

d) In the new GUI that pops up, enter in the text boxes exactly what you see in the example below.



- e) Click OK, then click the green 'Save Edits' button in the NRRWAVES Setup GUI.
- f) Confirm your settings: from the NRRWAVES product dropdown menu, select the product "SC.Y – Small Craft Advisory". Your GUI should match the one below; if it doesn't make adjustments to the appropriate fields and then save those changes. Don't forget to ensure your alert settings for the Non-Routine Broadcast Area!

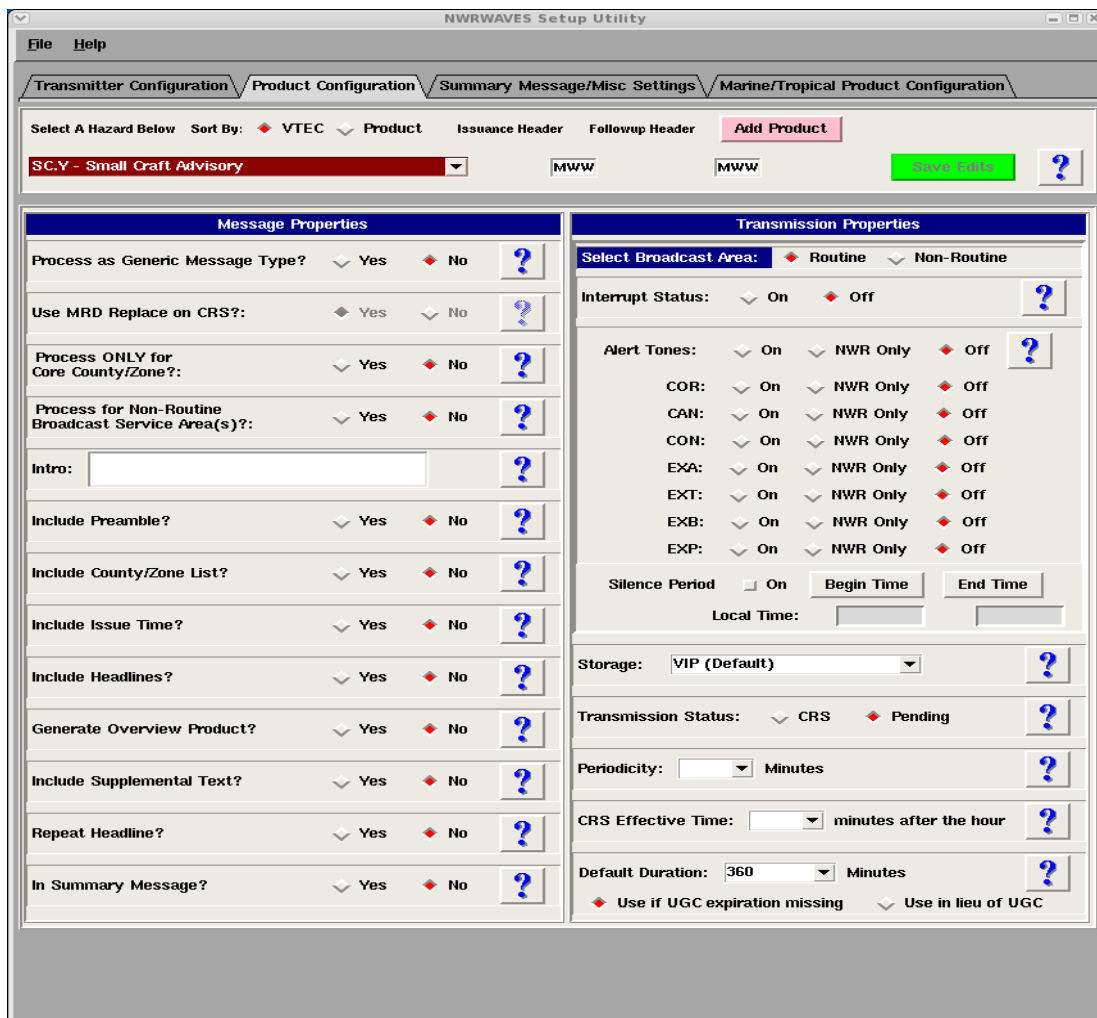

You are done configuring the SC.Y product in NRRWAVES. Since the SC.Y uses the CWF code for

EAS activation (and for simplicity sake we'll use the MWW follow-up header), your CRS database is already configured to accept the new SC.Y products.

2. Configuring your textdb triggers to execute NWRWAVES for the new MWW product(s). For a complete explanation of setting up text database triggers for NWRWAVES, please refer to the NWRWAVES User Documentation, pages 28-29:

- a. Log into an AWIPS workstation with a user account that has fxalpha group privileges and open up a terminal window.
- b. Change directories to the trigger directory.

**cd /data/fxa/siteConfig/textApps**

- c. Make a backup copy of your site trigger information, in case you need to revert back to it.

**cp siteTrigger.template siteTrigger.template.mmddyyyy**  
where 'mmddyyyy' is the numeric current date

- d. Edit your site trigger configuration.

**gedit siteTrigger.template &**

When you view this file, you will see a listing of AWIPS product identifiers, along with an action that is to be completed upon receipt of that product identifier into the text database. Enter the following line into your trigger

- a. file:

**CCCMWWXXX /awips/adapt/NWRWAVES/nwrwaves.csh**

Be sure to include every local office MWW product that you need for your NWR coverage areas. "CCC" refers to the legacy state node, while "XXX" is the 3-character WFO identifier.

- e. Save and exit your siteTrigger.template file
- f. Log onto dx1

**ssh dx1**

- g. Change user to fxa and type the following commands:

**su - fxa**  
**cd /awips/fxa/data/localization/scripts**  
**./mainScript.csh**

## APPENDIX E – A List of Product Identifier in OB9 with the new Instruction (CTA) Markers

AVA, AVW, CAE, CDW, CEM, CWF, EQW, EVI, FFA, FRW, HLS, HMW, LAE, LEW, MWS, MWW, NPW, NUW, RFW, RHW, SPW, TOE, VOW, WSW, FFA, FLS, FLW, EWW, FFS, FFW, SMW, SVR, SVS, TOR

NOTE: Some products, namely the stand-alone MWS (MWS that does not follow-up a SMW) and Non-Weather Emergency Message (NWEM) products that originate in HazCollect, initially will not contain CTA Markers.

## APPENDIX F – New features to support HLS & TCV products and operations

### New changes for the 2015 hurricane season (AWIPS OB14.3.2 delivery)

The 2015 Hurricane Local Statement (HLS) products will neither contain the VTEC segments nor the sub-headlines within each segment. This will be replaced by a brand new local WFO TCV product for tone alerting purpose (see TCV related test procedures document). Likewise, the new HLS products will essentially very similar to the current HLS's overview (OVR) product but with the following sections or subsections prescribed below:

- Main Headline (not a section, but begin and end with \*\*)
- NEW INFORMATION
  - CHANGES TO WATCHES AND WARNINGS
  - CURRENT WATCHES AND WARNINGS
  - STORM INFORMATION
- SITUATION OVERVIEW
- ~~SIGNIFICANT~~ POTENTIAL IMPACTS
  - WIND
  - SURGE
  - FLOODING RAIN
  - TORNADOES
  - OTHER COASTAL HAZARDS
- PRECAUTIONARY/PREPAREDNESS ACTIONS
  - EVACUATIONS
  - OTHER PREPAREDNESS INFORMATION
  - ADDITIONAL SOURCES OF INFORMATION
- NEXT UPDATE

As stated in the requirements provided by the OCWWS, the HLS section and subsection options should be configurable by the sites. Not every section will be present in every HLS. For instance, in-land WFOs will not have a “SURGE” or “OTHER COASTAL HAZARDS” section. **The default option for inclusion is just the**

“**Main Headline**” and “**SITUATION OVERVIEW**”. This is the latest news – the word “**SIGNIFICANT**” has been removed from the “**POTENTIAL IMPACTS**” section. Therefore, the site focal point will need to hand edit the HLS\_CONFIG.CCC or default files to remove the word “**SIGNIFICANT**”.

In order to support the selections of HLS sections and subsections, a simple shell script (non-graphical GUI) was implemented to assist the focal points to configure this HLS configuration file. The focal points can also edit these “/awips/adapt/NWRWAVES/HLS\_CONFIG.CCC (where CCC is 3 characters site Identification in upper case) or HLS\_CONFIG.default” files if desirable. The focal point will be required to edit these files when changing broadcast order of sections or subsections in the NWR and a new section/subsection arise in future. To test out this non-graphical GUI, NWRWAVES focal points (must be part of the **fxagroup**) can execute the following instructions in the AWIPS workstations:

Step 1: \$ cd /awips/adapt/NWRWAVES

Step 2: \$ ./configHLS.bash

The following menus would show up, one can repeat the choice (toggle on/off the “++”)

```
1) **MAIN** ++
2) NEW INFORMATION
3) - CHANGES TO WATCHES AND WARNINGS
4) - CURRENT WATCHES AND WARNINGS
5) - STORM INFORMATION
6) SITUATION OVERVIEW ++
7) SIGNIFICANT-POTENTIAL IMPACTS
8) - WIND
9) - SURGE
10) - FLOODING RAIN
11) - TORNADOES
12) - OTHER COASTAL HAZARDS
13) PRECAUTIONARY/PREPAREDNESS ACTIONS
14) - EVACUATIONS
15) - OTHER PREPAREDNESS INFORMATION
16) - ADDITIONAL SOURCES OF INFORMATION
17) NEXT UPDATE ++
18) Save as default & Exit
19) Save for a SITE & Exit
20) Quit
Please enter your choice: 19
Please enter 3 characters site ID
LWX
Options chosen:
Option 1 **MAIN**
Option 6 SITUATION OVERVIEW
Option 17 NEXT UPDATE
```

The above example shows - user had selected Options 1, 6 and 17. The user also wanted to save as a site configuration file choice 19 (e.g. LWX) instead of the default. A file with name of “HLS\_CONFIG.LWX” can be found with all the chosen options in the /awips/adapt/NWRWAVES directory. Note that if the

“HLS\_CONFIG.default” file does not exist, the NWRWAVES will also fall back to the default setting (e.g. main headline and situation overview sections). During the AWIPS installation, the following shows an example of the “HLS\_CONFIG.default” file with the default settings:

```
#####
#### NWRWAVES HLS Section and Subsections related config      ###
#### FILE: HLS.ini (prolog or header)                          ###
#### Run configHLS.bash to generate the following files        ###
#### (1) HLS_CONFIG.default                                    ###
#### (2) HLS_CONFIG.XYZ where XYZ is 3 chars site ID          ###
####   ###
#### The following sections don't have any subsections:       ###
#### (1)**MAIN** (2) SITUATION OVERVIEW (3) NEXT UPDATE       ###
####   ###
#### The following are the complete list of HLS sections      ###
#### and subsections:   ###
####   ###
#### **MAIN**   ###
#### NEW INFORMATION   ###
####     -CHANGES TO WATCHES AND WARNINGS                    ###
####     -CURRENT WATCHES AND WARNINGS                        ###
####     -STORM INFORMATION                                    ###
#### SITUATION OVERVIEW   ###
#### SIGNIFICANTPOTENTIAL IMPACTS                          ###
####     -WIND   ###
####     -SURGE  ###
####     -FLOODING RAIN   ###
####     -TORNADOES   ###
####     -OTHER COASTAL HAZARDS                                 ###
#### PRECAUTIONARY/PREPAREDNESS ACTIONS                         ###
####     -EVACUATIONS   ###
####     -OTHER PREPAREDNESS INFORMATION                       ###
####     -ADDITIONAL SOURCES OF INFORMATION RAIN               ###
#### NEXT UPDATE   ###
####   ###
#### For example, below shows if one just wants main         ###
#### headline, all 3 subsections of NEW INFORMATION and       ###
#### just the subsections of WIND and TORNADOES in the        ###
#### SIGNIFICANT POTENTIAL IMPACTS section plus the           ###
#### NEXT UPDATE where the comma "," is the delimiter:        ###
####   ###
#### **MAIN**   ###
#### NEW INFORMATION   ###
#### SIGNIFICANT POTENTIAL IMPACTS,WIND,TORNADOES             ###
####   ###
#####
#
**MAIN**
SITUATION OVERVIEW
**EndOfFile**
```



## New features to support TCV products and operations

The TCV will be used as the VTEC product. Only the Hazard headline will be included in the broadcast message paired with the hazards. TCV will generate one message per transmitter as opposed to the segment-oriented messages generated today.

**Note:** Sites need to manually run the following script once to update the TCV/HLS parameters in their current product.cfg file.

**ModTCVConfig.ksh** is a shell script that will update the current product.cfg file with all default values and parameters for HU.A, HU.W, TR.A, TR.W and HLS as below.

Process Message Type as - **Generic**

Include counties/Zones List – **Yes**

Tone Alert and Interrupt for **NEW and EXA**

Introduction – **Blank**

Action	Issuance Header	Follow-up header
HU.A	HUA	HUA
HU.W	HUW	HUW
TR.A	TRA	TRA
TR.W	TRW	TRW
HLS	HLS	HLS

For setting up generic message types on CRS system, sites need to follow the steps described in section “SETTING UP GENERIC MESSAGE TYPES” on page 39 of this document.

### **Administrator’s Role: (must be performed in-advance)**

The NWRWAVES administrators will no longer need to set up the AWIPS text database triggers in order to process the HLS and TCV products. This is a new feature starting from 2015 hurricane season. The HLS and TCV triggers will happen automatically via the SBN ingest. A new script namely, “nwrwavestcv.csh” will be invoked with the TCV/HLS of 9 characters PILs as the input argument. For any land-lock or non-marine sites with no interest to receive the HLS/TCV products, please do nothing. For any other sites with interest to receive its own TCV/HLS products as well as from the neighbors’, the focal point should create a file “TROPICAL\_PILS.txt” in the “/awips/adapt/NWRWAVES” directory and provide the 9 characters TCV/HLS PIL per line. For example, the followings show how WFO at Morehead City, NC (MHX) can process the TCV/HLS product PILs from its own and the neighbors:

RDUHLSMHX  
RDUTCVMHX  
RDUHLSILM  
RDUTCVILM  
WBCHLSAKQ  
WBCTCVAKQ

Once the incoming SBN TCV/HLS PIL matches the PIL in the list, the “nwrwavestcv.csh” shell script calls “textdb -r PIL” and invokes the regular NWRWAVES (nwrwaves.tcl) script to run.

**Routine Cleaning of some of the NWRWAVES directories**

This is just a reminder that there are several NWRWAVES subdirectories (e.g. /BACKUP and /ERROR) that require manual clean up after a long period of time. Remember that every time when the administrator brings up the Setup Utility GUI, a backup copy of the HLS configuration file will be saved in the /BACKUP subdirectory.

## APPENDIX G – NWRWAVES NWEM Processing

### Non-Weather Emergency Product Information

Event Code	AWIPS Priority	Event (Product) Name
AVW	Warning/Exclusive	Avalanche Warning
CDW	Warning/Exclusive	Civil Danger Warning
CEM	Warning/Exclusive	Civil Emergency Message
EQW	Warning/Exclusive	Earthquake Warning
EVI	Warning/Exclusive	Immediate Evacuation Warning
FRW	Warning/Exclusive	Fire Warning
HMW	Warning/Exclusive	Hazardous Materials Warning
LEW	Warning/Exclusive	Law Enforcement Warning
NUW	Warning/Exclusive	Nuclear Power Plant Warning
RHW	Warning/Exclusive	Radiological Hazard Warning
SPW	Warning/Exclusive	Shelter In Place Warning
VOW	Warning/Exclusive	Volcano Warning
AVA	Watch/High	Avalanche Watch
CAE	Watch/High	Child Abduction Emergency
LAE	Watch/High	Local Area Emergency
TOE	Watch/High	911 Telephone Outage Emergency
ADR	Other/General	Administrative Message/Follow up Statement
DMO	Configurable	Practice/Demo Warning
NIC*	Other/General	National Information Center
NPT*	Configurable	National Periodic Test
RMT**	Configurable	Routine Monthly Test
RWT**	Configurable	Routine Weekly Test

\* not yet defined and not implemented in HazCollect at this time.

\*\* not implemented in HazCollect at this time.

### Ensure county code “000” in the localUGCllookup.table and product.cfg file

All National and state-wide NWRWAVES will use “000” in the UGC rather than individual county Listening Area Codes (LACs). For example, a statewide message for Kentucky would be encoded as “KYC000-” rather than “KYC007-035-039-” for the three counties in the state. The “KYC000” code needs to map to every transmitter which will broadcast to any part of Kentucky.

The following is the procedure for adding county “000” in NWRWAVES:

1. Create an entry of county code “000” for localUGCllookup.table
  - a. Select *NWRWAVES setup utility* window from *NWRWAVE browser*
  - b. The first tab of “*Transmitter Configuration*” should be displayed
  - c. The first transmitter (BLF in Paducah case) will be selected by default
  - d. Click on the “Edit Local LACs” button

- e. Enter each entry accordingly (see Figure 1) for creating “KYC000”
- f. Select “Save Edits”
- g. Repeat steps d. to f. if the site involves multiple states (e.g. “ILC000” and “MOC000” for Paducah).
- h. When completed, the localUGClookup.table file in /awips/adapt/NWRWAVES/bin directory should contain:

```
#LOCAL UGC LOOKUP TABLE CREATED BY NWRWAVES
ALL Kentucky (AMBER ONLY),KY,PAH,C,KYC000
ALL Missouri (AMBER ONLY),MO,PAH,C,MOC000
ALL Illinois (AMBER ONLY),IL,PAH,C,ILC000
```

2. Assigning the county code for a transmitter (a minimal of one will do)
  - i. Locate the lower left scroll window for “Unused Counties/Indep. Cities for SiteID (e.g. PAH)”
  - j. Left click on the “000” county code (e.g. KYC000)
  - k. Hit the “→” button associates with the “Routine Broadcast Selected Counties/Zones” on top right scroll window.
  - l. Repeat steps j. to k. if the site involves multiple states. (see Figure 2)
  - m. Select “Save Transmitter Edits” (Green button)
  - n. Select File menu ->Save & Exit option.

Once the county code of “000” is defined and configured, the NWRWAVES should be able to locate the newly defined UGC code (e.g. KYC000, ILC000 and MOC000).

## **Basic checklist for testing HazCollect with NWRWaves**

1. Check /awips/adapt/NWRWAVES/product.cfg via NWRWAVES setup utility GUI. From the NWRWAVES setup utility GUI select Product Configuration (second tab) and for each NWEM product, select the following options and save it when it is done.

- Process as Generic Message Type: **\*Yes\***
- Process Only for Core County/Zone: **\*No\***
- Process for Non-Routine Broadcast Service Area(s): **\*Yes\***
- Include Country/Zone List: **\*Yes\***
- Include Issue Time: **\*No\***
- Include Headlines: **\* Yes\***
- Generate Overview Product: **\*No\***
- Include Supplemental text: **\*No\***
- Storage: **\*VIP (Default)\***
- Transmission Status: **\*CRS \***
- Use if UGC expiration missing: **\*Yes\***

2. Check /awips/fxa/postgres/fxatextTriggerActions.txt file and make sure NWEM products in this the trigger file, for example,

SFDADPAH | /awips/fxa/bin/startTransmitHazWarnings.csh GEN

...

...

## **AWIPS Software Modification**

- Changes to /awips/fxa/bin/transmitHazardWarnings.pl

In the sendToCRS() section of the script make the following changes.

Modify the following line from:

```
my $formatter = "/home/CRS/NWEM/nwrnwem.csh $product_id $crs_section$trans_file";
```

to

```
my $formatter = "/awips/adapt/NRWWAVES/nrwwaves.csh $product_id";
```

## APPENDIX H – Add/Delete/Update Text Database Triggers from AWIPS II

Triggers are maintained in AWIPS II basically in the same way they are maintained in AWIPS I through the /data/fxa/siteConfig/textApps/siteTrigger.template file. The structure of this file has not changed from AWIPS I.

1. Triggers run as user awips from within edex on dx3 and dx4.
2. The product files are written to /awips2/edex/data/fxa/trigger; therefore, most triggers scripts will have to be changed for this new directory. This directory is only available on dx3, dx4, px1, and px2.

Use the config\_awips2.sh script to invoke changes to the siteTrigger.template file.

Refer to the AWIPS II Site Migration Guide for instructions on running config\_awips2.sh.

4. siteTrigger.template file will likely be a symbolic link to an AWIPS I/II-specific file. Make sure you are changing the appropriate file for AWIPS I/II use.
5. The location of your trigger script on the system has changed from AWIPS I. All local application programs and scripts are recommended to be in /localapps/runtime. This is a long-term goal. At present, it is not a hard requirement when initially switching to running AWIPS II operationally. All AWIPS I directories such as /data/local and /awips/dev remain unchanged when running AWIPS II.
6. When porting AWIPS I trigger scripts, it is like that there will be no need to set environment variable FXA\_HOME or source readenv.(c)sh. These should be removed from the scripts.

Triggers in AWIPS II are run as edex Subscriptions and not as postgres database triggers.

The subscription command should not be used to add or delete triggers. Use siteTrigger.template and config\_awips2.sh.

### Viewing Current Triggers in AWIPS II

You can view your current AWIPS II triggers/subscriptions via the following command:

```
/awips2/fxa/bin/subscription -o read -p PIL
```

Note: The subscription does have other commands as well.

### Updating Triggers in AWIPS II

As root, ssh to DX1

- Update dx1:/data/fxa/siteConfig/textApps/siteTrigger.template
- Remove any triggers that are no longer relevant.

- Update any script locations which may have changed.

· cd /data/fxa/sdc (as root on DX1)

· ./config\_awips2.sh -f triggers XXX (where XXX is your 3-letter site ID in CAPS)

Note: The -f will purge and repopulate the triggers with national triggers as well as your siteTrigger.

-Once the script is completed, you will need to bounce the asyncScheduler on px1 to append the asyncScheduler triggers. To do this:

- As user fxa on PX1

```
§ stopAsyncScheduler
```

```
§ startAsyncScheduler
```

· When done, an output copy of the triggers is located in

```
dx1:/var/tmp/awipsTriggersSetup.txt
```

## APPENDIX I – Setting up Red Banner Alert for error messages in AWIPS II

Beginning AWIPS II OB Release 16.1.1, the red banner alert message call of “fxaAnnounce” was replaced by AWIPS II’s “sendNotificationMsg” call. In AWIPS I, the Red Banner alert messages would send to **all** workstations.

To set up the NWRWAVES banners in AWIPS II, the installers or administrators will need to logon to the graphic **or text** workstation(s) where the sites want the NWRWAVES error messages show up. Then the installer will perform the following steps:

1. Right click on the AlertViz icon
2. Click on "Configuration..."
3. Select "NWRWAVES" from the Sources list
4. Click "Retrieve..."
5. Select "Default (Base)" from the Configuration list
6. Click "Okay"
7. **Verify that the text boxes under PRIORITIES of 0, 1 and 2 are all checked.**
8. Click "Restart"

Basically this bypasses whatever USER or WORKSTATION override that exists and sets the AV configurations to the baseline AV configurations for NWRWAVES. **The NWRWAVES software uses CATEGORY of "SEND" and "NWRWAVES" as Sources to communicate with the forecasters.**

Users should consult the AWIPS II Alert Visualization Configuration related documentation for details.



## **APPENDIX J –A new RiverPro functionality for Integrate Hazard Information Services in NWRWAVES for flood (point-specific) products**

Beginning AWIPS Release OB16.1.1, a new option of RiverPro functionality would be built into the NWRWAVES software for flood (point-specific) products to support the Integrate Hazard Information Services. Previously when AWIPS RiverPro Application creates and issues a segmented, point-specific hydrologic product, NWRWAVES generates NOAA Weather Radio (NWR) messages automatically (e.g., FLW, FLS). NWRWAVES produces a distinct message for each segment and for each transmitter associated with the segment. If many forecast points are in flood (e.g especially CON/EXT for a long period of time) and some of those forecast points are associated with more than one transmitter, the number of NWRWAVES hydro messages may lead to a long broadcast cycle playing on some NWR transmitters. Additionally, the NWRWAVES messages are essentially the bullets from the official NWSI 10-922 Product and the length of these may add to the long broadcast cycle. An AWIPS2 DCS 17379 was implemented to support this migration of RiverPro functionality into NWRWAVES. A prototype was written to consolidate all river forecast points (segments) common to a transmitter, thus shortening the broadcast cycle for each of the transmitters. This feature is especially beneficial to those WFO sites along the Mississippi River and its major tributaries.

It is important to know before the sites proceed to use this RiverPro option since there are some limitations:

The output PIL in the CRS header is now always hardwire to “CCCFLSN01 to CCCFLSN99” or “CCCFLWN01 to CCCFLWN99”. The “N##” denotes transmitter number from 01 to 99. Therefore, the sites **MUST** create the same PIL for matching in their CRS system in order for the NWR broadcast. This is not the same as the traditional PIL of “CCCFLSXXX” or “CCCFLWXXX” where CCC is the node (e.g. WBC for WFO LWX) and where XXX is the 3 characters transmitter mnemonic (for transmitter specific option) or site ID (e.g. LWX for generic option). Therefore, the CRS focal point must re-configure the CRS for the “CCCFLSN##” or “CCCFLWN##” for this new RiverPro option.

Furthermore, no VTEC Summary entries would be updated in NWRWAVES. Thus, no MRD replacements show up in the CRS output messages. Likewise, the summary product (SUM) will not be supported for this FLW/FLS products. Note that all alerts and interrupts will be disabled in the output for this RiverPro option.

To turn on the new RiverPro feature, site focal point can use the NWRWAVES Setup Utility GUI via the NWRBrowser to enable the option (see orange box in figure J-1 below) This option only shows up for product types of “FL.W”, “FL.Y”, “FLS” and “FLW”.

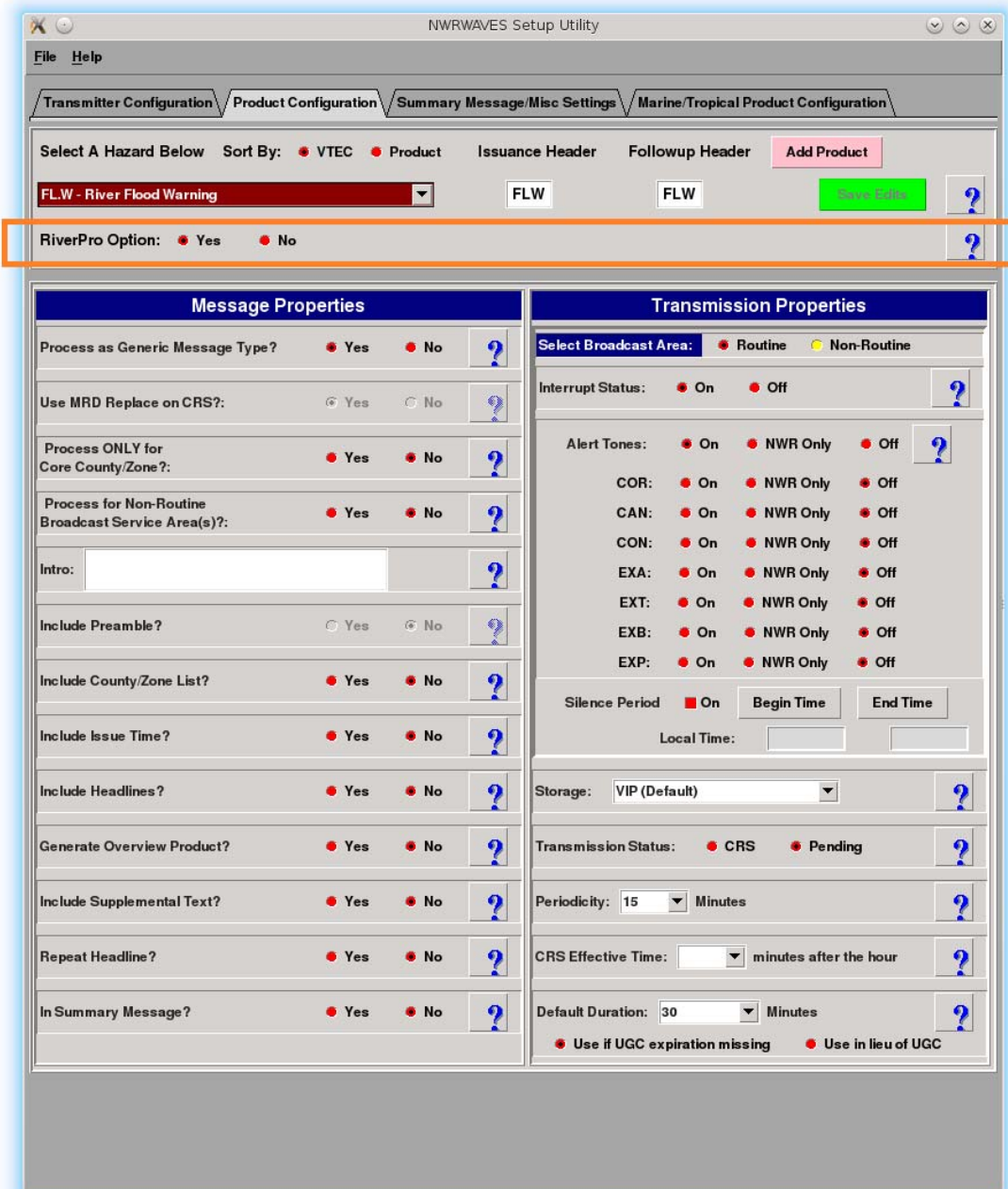

Figure J-1 – Configuring RiverPro option in NRRWAVES

# **Appendix P**

## **Diagnosing System Health**

## Appendix P. Diagnosing System Health

### Table of Contents

	<i>Page</i>
P.1 AWIPS II Communications Review .....	1
P.1.1 SBN Ingest .....	1
P.1.2 ORPG Ingest.....	3
P.1.3 LDAD Ingest .....	4
P.1.4 Product Retrieval.....	6
P.1.5 CAVE Communication .....	7
P.2 Diagnostic Tools .....	8
P.3 AWIPS II System Monitor.....	13
P.3.1 System Monitor Main Configuration File.....	17

### List of Exhibits

Exhibit P.1-1. High-Level Communications Flow in AWIPS II.....	2
Exhibit P.1.2-1. RPG Ingest Data Flow .....	3
Exhibit P.1.3-1. High-Level LDAD Ingest Data Flow .....	5
Exhibit P.3-1. AWIPS II System Monitor .....	14
Exhibit P.3-2. Radar.xml Configuration File.....	15
Exhibit P.3-3. Radar Product .....	16
Exhibit P.3.1-1. params.xml Configuration File.....	18

### List of Tables

Table P.1.1-1. LDM Processes, Users, Log Files .....	2
Table P.1.3-1. LDAD Router Processes in AWIPS II .....	6
Table P.2-1. Tools Pertinent to AWIPS II .....	8
Table P.2-2. Log Locations for AWIPS II Components.....	10
Table P.2-3. Specific Information for Log Files.....	10
Table P.3-1. AWIPS II System Monitor Cron Entries.....	15
Table P.3-2. AWIPS II System Monitor Configuration Files.....	15
Table P.3-3. AWIPS II System Monitor Configuration Files Tags.....	16
Table P.3.1-1. AWIPS II System Monitor params.xml XML Definition.....	18

This appendix provides an overview of tools that can be used to diagnose system health. The focus is on those components that are changed or completely new in the AWIPS II architecture. A brief overview is provided to help define the flow of some of the diagnostic tools.

AWIPS II introduces a number of new processes, and with those processes come a new set of log files to monitor. Also, the move to a load-balanced clustered suite of software (Environmental Data Exchange (EDEX)) introduces a new processing paradigm in which the server that is not tied up with other tasks performs the next one. Because of this, it is worth noting that there is no guarantee that one server's software will process a specific piece of data; administrators need to become comfortable with checking two sets of logs.

The flow of data within the AWIPS II system (as described in Chapter 4) differs from the way AWIPS I stores and retrieves data. This will affect how certain scenarios will be diagnosed in comparing similar situations with AWIPS I.

Finally, the change in data storage paradigm that heavily relies on a combination of metadata and Hierarchical Data Format – 5 (HDF5) flat file storage was the catalyst for redesigning the AWIPS System Monitor. The new tool will provide information similar to that provided by the AWIPS I version in diagnosing system health.

## ***P.1 AWIPS II Communications Review***

AWIPS II relies heavily on communication between processes in storing and retrieving products. A high-level diagram of process communication within AWIPS II is provided in Exhibit P.1-1. A brief review of specific communications within AWIPS II follows the exhibit.

### ***P.1.1 SBN Ingest***

Data is received via the Satellite Broadcast Network (SBN) Digital Video Broadcaster (DVB)s and multicast over a private Local Area Network (LAN) to the Communications Processor – Satellite Broadcast Network (CPSBN) processors where it is captured by the `noaaportIngest` process. `noaaportIngest` replaces the `dvb_multicast` and `readnoaaport` process. `noaaportIngest` reads data off the SBN feed and inserts it into LDM. LDM is configured with `pqact.conf` (running on `cpsbn1`); it writes the product to physical storage on a filesystem in `/data_store` and sends a message into the Queue Processor Interface Daemon (Apache AMQP Message Broker) (QPID) Java Messaging Service (JMS) `external.dropbox` queue indicating that a product is available for decoding. The message contains the first 100 characters of the product, which includes the World Meteorological Organization (UN) (WMO) header for product identification, as well as the file path and file name under which the product was stored under `/data_store`.

The next available EDEX process will read from the JMS queue and will act on the next available message, and then initiate the proper plugins to work on the data based on the information contained in the JMS message. The EDEX process identifies the products using the WMO header contained in the message and compares it to a pattern in the distribution eXtensible Markup Language (XML).

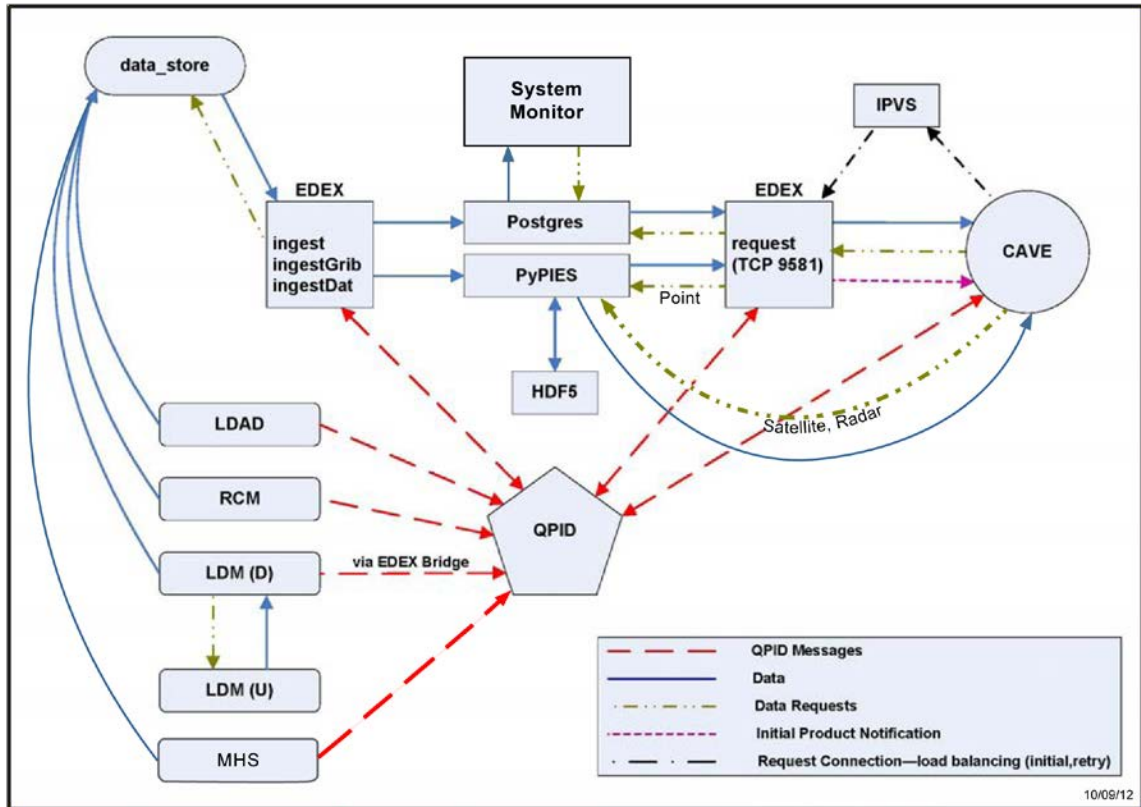

Exhibit P.1-1. High-Level Communications Flow in AWIPS II

Data storage by EDEX is done by sending messages to the PostgreSQL engine and to Python Process Isolated Enhanced Storage (PyPIES) running on dx2f. PostgreSQL stores necessary data into the proper tables and PyPIES is charged with HDF5 file storage.

**Note: In Exhibit P.1-1, LDM (D) and LDM (U) do not exist. They need to be referred as LDM.**

**Potential Things to Check: Note:** The following is not an all-inclusive list; rather, it is a list of common things to check when troubleshooting SBN ingest issues.

- Are all the ingest processes running on the LDM host? Table P.1.1-1 shows a list of processes and which user(s) run(s) each process for checking via the *ps* command.

Table P.1.1-1. LDM Processes, Users, Log Files

Process	User	Log
noaaportIngestor -b 10000 -m 224.0.1.1 -n -u 3 -t mhs -r 1 -s NMC	ldm	~ldm/logs/nwstg.log
noaaportIngestor -b 10000 -m 224.0.1.2 -n -u 4 -t mhs -r 1 -s GOES	ldm	~ldm/logs/goes.log
noaaportIngestor -b 10000 -m 224.0.1.3 -n -u 5 -t mhs -r 1 -s NMC2	ldm	~ldm/logs/nwstg2.log
noaaportIngestor -b 10000 -m 224.0.1.4 -n -u 6 -t mhs -r 1 -s NOAAPORT_OPT	ldm	~ldm/logs/oconus.log
noaaportIngestor -b 10000 -m 224.0.1.5 -n -u 7 -t mhs -r 1 -s NMC3	ldm	~ldm/logs/nwstg3.log
noaaportIngestor -b 10000 -m 224.0.1.6 -n -u 4 -t mhs -r 1 -s ADD	ldm	~ldm/logs/goes_add.log

- Check to ensure the LDM process is configured properly to act on a product based on its WMO header as configured in the /usr/local/ldm/etc/pqact.conf file.
- Check to ensure that the /data\_store directory is mounted on the NAS2.  
**Note:** /data\_store volume is moved off the NAS1 onto NAS2.
- Check to ensure that QPID is running and it is not having problems accepting connections. Look in the LDM ldmd.log file for the string “Cannot connect to remote EDEX instance” and check to make sure qpidd is running on the cp1f host.
- Check to ensure the EDEX processes are running on DX3 and DX4, and are not processing slowly. Check the latency and processing times in the EDEX logs.
- Check to ensure the /data\_store directory is also mounted off NAS2 on the DX3 and DX4 so EDEX can access the files it is supposed to decode. You may see a lot of “file not found” messages inside of large java stack trace error messages in the EDEX logs.

### P.1.2 ORPG Ingest

Data is received via the Transport Control Protocol (TCP) connection between the AWIPS II Radar Configuration Manager (RCM) (also known as the AWIPS II Radar Server) and the Open Radar Product Generator (ORPG). As products are received, the RCM process will write to physical storage and place a message in the QPID JMS queue. From this point on, the path is the same as SBN Ingest. Exhibit P.1.2-1 provides a high-level overview of the ingest flow from the radar product generator (RPG).

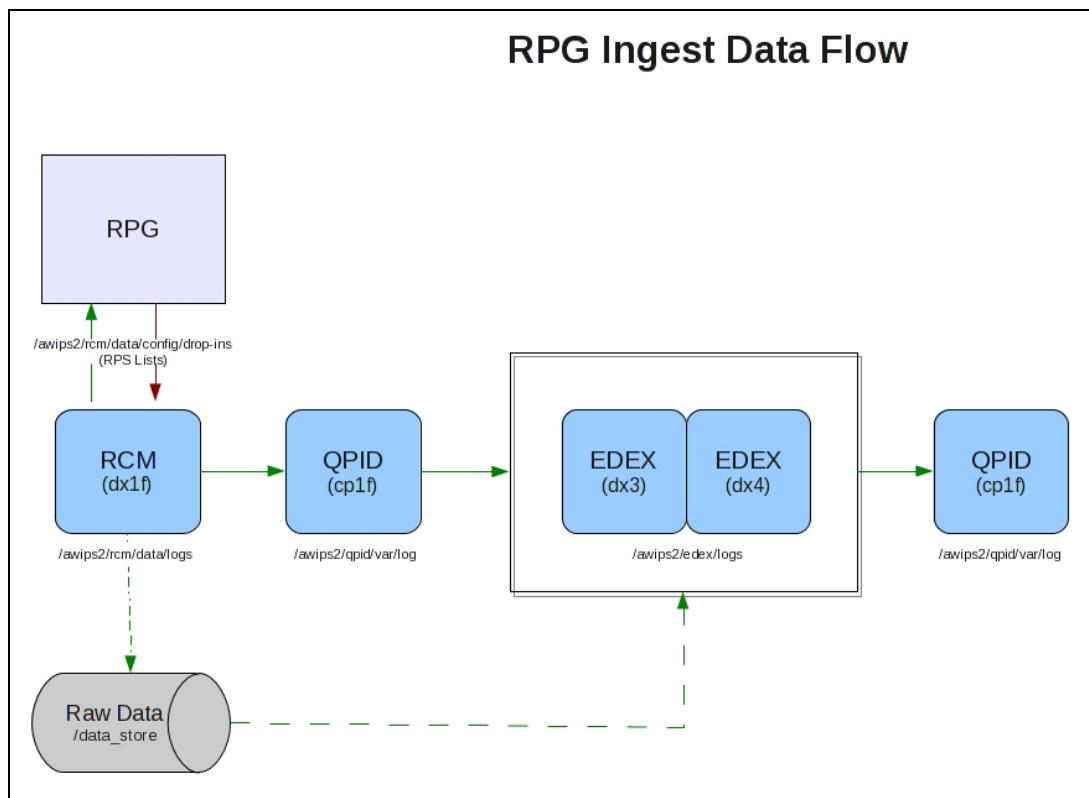

**Exhibit P.1.2-1. RPG Ingest Data Flow**

**Potential Issues / Things To Check: Note:** The following is not an all-inclusive list; rather, it is a list of common things to check when troubleshooting ORPG ingest issues.

- A network path to the ORPG must be in place. *Ping* is a good utility to check this path.
- RCM must be configured with the correct Internet Protocol (IP) of the ORPG, as well as the port and password. Check the config.xml in /awips2/edex/data/config/persist.
- The RCM process must be running. Use the *ps* command and tail the log in /awips2/rcm/data/logs to check for the status of the RCM process.
- The /data\_store directory is mounted on the NAS2. [**Note:** All hosts mount volume off NAS2.]
- Check to ensure the /data\_store directory is also mounted off NAS2 on the DX3 and DX4 so EDEX can access the files it is supposed to decode. You may see a lot of “file not found” messages inside of large java stack trace error messages in the EDEX logs.
- QPID must be running and must not be having problems accepting connections.
- The EDEX processes must be running on DX3 and DX4, and must not be processing slowly. Check the latency and processing times in the EDEX logs.

### P.1.3 LDAD Ingest

The ingest of Local Data Acquisition and Dissemination (LDAD) into the LDAD Servers (LS) and across the firewall has not changed. In fact, up to the point of preprocessing, ingest has not changed in AWIPS II. The following steps still occur in AWIPS II:

1. Data is placed into /data/Incoming on LS1.
2. The listener process on px2f is notified of new products by the newLDADdataNotification and CO\_Serv processes on the LS1.
3. The listener process SCPs the data file over to px2f into /data/fxa/LDAD/tmp on px2f and the newLDADdataNotification moves the product into /data/ldad/Processed on LS1.
4. The listener process checks the LDADinfo.txt file to see if preprocessing is needed. If so, it runs the appropriate preprocessor where the data is reformatted and placed into /data/fxa/LDAD/Raw. If no preprocessing is needed, it puts the data directly into /data/fxa/LDAD/Raw.

At this point the routing paradigm is different. Rehosted LDAD processes write to raw data storage and place a message in the QPID JMS external.dropbox queue. From this point on, the path is the same as the SBN Ingest. Exhibit P.1.3-1 is a high-level depiction of the changed portion of the process.



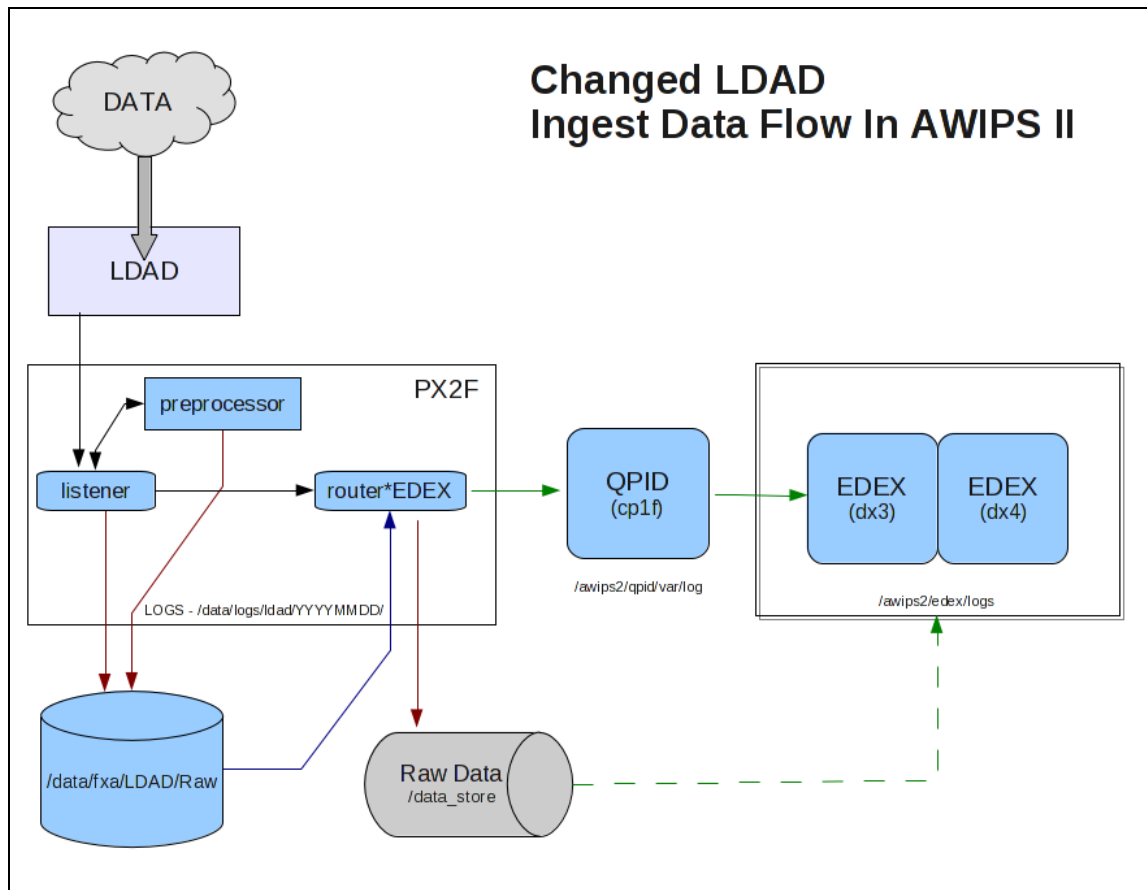

**Exhibit P.1.3-1. High-Level LDAD Ingest Data Flow**

There is potential for data to come in which is not handled by a router process in AWIPS I or in AWIPS II. For instance, raw Gridded Binary (GRIB) or GRIB2 data, which is ingested through LDAD, needs to be put somewhere for processing. That data can be placed into `/awips2/edex/data/manual`, which is an ingest endpoint that EDEX monitors for new products. When found, it attempts to decode the data based on the same rules it uses if it is notified of a raw product storage via the QPID JMS queue, with one extra step. If no WMO header is found in the product, then it will attempt to use the file name when matching regular expressions within distribution XML files.

**Potential Issues / Things To Check: Note:** The following is not an all-inclusive list; rather, it is a list of common things to check when troubleshooting LDAD ingest issues.

- All current processes that run on LS1 should be running and configured as they are today. Normal troubleshooting techniques apply.
- The file `LdadPatterns.txt` must be rehosted to the AWIPS II version of the file, which allows execution of the new `router*EDEX` processes. Table P.1.3-1 lists the router processes that should be running in AWIPS II and whether or not they are modified for use in AWIPS II or the exact same process as in AWIPS I. Use a `ps` command to check to see if they are all running. Note that only the modified, rehosted applications are ones which put messages on the QPID queue for EDEX decoding.

**Table P.1.3-1. LDAD Router Processes in AWIPS II**

Process Name	Modified or Legacy
routerLdadDecoder	Legacy
routerStoreTextEDEX	Modified
routerStoreNetcdf	Legacy
routerStoreEDEX	Modified
routerShelfEncoderEDEX	Modified
routerStoreAkBlpEDEX	Modified

- The proper libraries need to be installed for the rehosted router\*EDEX processes to put messages on the QPID queue. Use `rpm -q awips2-notification` to check for this rpm.
- The file `/awips/fxa/data/edex-info.txt` must exist and must have the proper host running QPID in the first line, which should look as shown below:

**edex.msg amqp:tcp:cp1f:5672**

- The `/data_store` directory is mounted on the NAS2.
- The `/awips2/edex/data/manual` directory needs to be mounted from the Network Attached Storage (NAS1) to place files that are not handled by one of the rehosted router\*EDEX processes listed in Table P.1.3-1.
- The EDEX processes need to be running on DX3 and DX4, and you need to ensure they are not processing slowly. Check the latency and processing times in the EDEX logs.
- Not all the data that comes in via the LDAD system has WMO headers; therefore, the EDEX distribution XML files need to be properly configured to notify the proper decoding plugin based on the file name stored into the `/data_store` directory.

#### **P.1.4 Product Retrieval**

CAVE is the main interface between a user and the data in AWIPS II. It first connects to EDEX through Internet Protocol Virtual Server (IPVS) when it starts. The product retrieval itself is performed through communications with the EDEX request server.

When a menu is first displayed, CAVE is requesting the most recent product time from the metadata database for each of those configured menu items. This request is sent through the connection with EDEX request process. While the request is being sent, and before a reply is received, the menu will show `??.????` for the product time. Once a reply is received, the question marks will change to the product time of the most recent product for that menu item; or, if the product has no recent time in the metadata database, it will display as `--.----`.

If the question marks stay (i.e., they do not change to product times or to the dashed notation) because no product stored matched that menu item, there could be a problem with the communication to the EDEX request process, or from the EDEX request process to the metadata database.

Once a product is loaded to a perspective's display in CAVE, the product itself is updated by a broadcast to a specific topic to which CAVE is listening housed within QPID. When the successful product store is broadcast, the data should update, as well as the time, for the most recent product on the menus that have been previously displayed.

All product time retrievals go through an EDEX request process. However, in accessing the information within HDF5, CAVE communicates directly to PyPIES. For example, if the client has requested data which resides in hdf5 store, then it communicates directly with PyPIES on dx2f to retrieve the necessary information to visualize the data.

**Potential Issues / Things to Check.** The following is not an all-inclusive list; rather, it is a list of common things to check when troubleshooting product retrieval issues.

- Ensure IPVS is running, and that it detects at least one EDEX request server running on either DX3 or DX4.
- Ensure that there is a network path to the floating IP managed by IPVS from each Linux Workstation (LX) or Linux Text Workstation (XT). Using *ping ec* is a good start. If a user gets a banner when starting Alert Visualization (AlertViz) (or when it automatically starts when the user logs in to the desktop environment) asking for localization preferences, and the box for the localization server is red, then the path to the server is broken.
- Ensure that the user is configured to use *ec* as the localization server, and not DX3, DX4 or any other server.
- Ensure that at least one EDEX request process is running on either DX3 or DX4. Look in the */awips2/edex/logs* if there are problems starting the EDEX request process.
- Ensure that the PostgreSQL database is running on dx1f.
- Ensure that PyPIES is running on dx2f.
- Ensure that the */awips2/edex/data/hdf5* mount from the Direct Attached Storage (DAS) is mounted on dx2f.

### **P.1.5 CAVE Communication**

Different applications integrated within the CAVE have need to communicate among themselves – for example, the WarnGen application within the D2D perspective and the TextWS application. When WarnGen is running, and a polygon and associated warning attributes have been established to the forecaster's liking, the Create Text button is pressed. At this point, the Text Workstation application running on the configured host will display the text message for editing and transmission. This inter-application communication is done through a QPID JMS queue. There is no direct traffic to the XT from the LX in terms of communication between the AWIPS II programs.

CAVE also needs to communicate in order to disseminate products. This process is completed by sending a message to the EDEX request server to which it was connected via IPVS. The EDEX server, once it receives a transmission request, uses an application developed to transmit the product using the AWIPS I Message Handling System (MHS) code already installed on the system.

**Potential Issues / Things To Check: Note:** This is not an all-inclusive list; rather, it is a list of common things to check when troubleshooting inter-CAVE communication issues.

- Ensure that the Text Workstation host setting under the Text Workstation preferences is set to the accompanying XT to the LX which is being used. Access the preferences by opening CAVE → Preferences, then selecting ‘Text Workstation’ from the selection list to the left.
- Ensure that there is a network path to the floating host of cp1f, where QPID runs. Using *ping cp1f* is a good test of this path.
- Ensure that QPID is running along with the a2cp1apps package, and that there are no errors in the qpuid logs.

## P.2 Diagnostic Tools

Most of the tools that are useful in AWIPS I at a system level can be used in AWIPS II to help diagnose system issues. These include, but are not limited to:

- top (CPU monitoring)
- vmstat, free (memory monitoring)
- iostat (disk Input/Output (IO) monitoring)
- df (disk usage monitoring)
- tail, grep, less (log viewers and parsers)

However, a few new tools, or lesser known tools, can be of use as well. Table P.2-1 organizes and describes some of the new tools pertinent to AWIPS II.

**Table P.2-1. Tools Pertinent to AWIPS II**

Tool		Description
LDM	<i>ldmadmin watch</i>	Running as system user <i>ldm</i> on the host running the LDM, one can issue this command to watch the most recent data products to arrive in the queue (successful inserts).
	<i>ldmadmin watch -f FEEDTYPE</i>	Can be used with optional <i>-f FEEDTYPE</i> arguments where FEEDTYPE is a valid LDM feedtype.  This utility can also be used to monitor the latency of the data coming from the LDM host.  Note that this does not indicate a successful action taken by pqact process.
	<i>ldmadmin pqactcheck</i>	Utility run as system user <i>ldm</i> that checks the syntax of the pqact.conf file.
	<i>ldmadmin pqactHUP</i>	Utility run as system user <i>ldm</i> which will force the LDM system to re-read the active pqact.conf file(s) and begin using the new rules, assuming the file is correctly formatted.
	<i>ldmadmin tail</i>	This utility, run as system user <i>ldm</i> , tails the LDM log file for easy monitoring without being in the logs directory. Useful for seeing which products have matched an entry in the pqact.conf file.

	Tool	Description
	<i>Ldmping</i>	Run as system user <i>ldm</i> . Specifically designed to check the availability of an LDM server.
	<i>notifyme</i> <i>notifyme -vl- -h cp1f- p 'REGEX'</i>	Run as system user <i>ldm</i> . This utility connects to an LDM instance and issues a specific REQUEST to see if a product can be requested. Can be used with the optional <i>-p</i> argument which allows a regular expression pattern to be sent.  Useful for testing regular expressions that can be used in the <i>pqact.conf</i> file.
	<i>pqmon</i> <i>pqmon -i X</i>	Utility that monitors the LDM queue file on the disk. The following are useful columns in the output of the utility: <ul style="list-style-type: none"> <li>• <i>nprods</i> – Number of products in the queue</li> <li>• <i>maxprods</i> – Maximum number of products in the queue so far</li> <li>• <i>age</i> – The age, in seconds, of the oldest product in the product queue</li> </ul> This can be used with an optional <i>-i</i> argument to iterate a new line of information every <i>X</i> number of seconds.
Database	<i>pgadmin3</i>	Graphical tool which allows a user to explore the database structure and table schema in a visual way.  Database queries can be made to extract data.  <b>Exercise caution</b> when using this tool, as it has the ability to change rows in the database if care is not taken.  Utility is available in AWIPS I; however, the database user name has changed. It should now be <i>awips</i> and not <i>pguser</i> .
	<i>psql</i>	Command line tool which allows a user to test a connection to, and peruse the data within, a PostgreSQL database engine.  Utility is available in AWIPS I; however, the database user name has changed. It should now be <i>awips</i> and not <i>pguser</i> .
QPID	<i>qpqid-stat -q</i>	Command line tool run on the host which is running QPID that allows a user to see the status of individual JMS queues and topics which are housed by QPID.  Optional command line arguments allow for sorting by column name ( <i>-S colname</i> ) and limiting the number of queues returned ( <i>-L NUM</i> ).
HDF5	<i>hdfview</i>	Graphical user interface for looking in HDF5 files.
	<i>h5stat</i>	Command line utility which can provide information about an HDF5 file. This can provide the number of datasets in a file, and other information about the HDF5 file itself.
	<i>h5ls</i>	Command line tool which can list the information in each of the datasets. The <i>-r</i> option is a powerful recursive option that will list all data in all groups of the HDF5 file. Or a user can view group-by-group.
	<i>h5dump</i>	Command line utility which can be used to view the contents of an HDF5 file.
IPVS/Pulse	<i>ipvsadm</i>	Command line tool that can be used to query how many downstream EDEX Request servers IPVS/Pulse has registered, and to see how many connections to each EDEX Request server currently are made.

The available logs are shown in Table P.2-2.

**Table P.2-2. Log Locations for AWIPS II Components**

Server	Process	Log Directory
dx1f	Radar Server	/awips2/rcm/data/logs/radarserver.log
	PostgreSQL DBMS	/awips2/data/pg_log/postgresql-YYYY-MM-DD_HHMMSS.log /awips2/data/pg_log/postgresql-{Monday- Sunday}.log
dx2f	PyPIES	/awips2/pypies/logs/pypies.log.YYYY-MM-DD /awips2/pypies/logs/pypiesHourlyStats.log.YYYY-MM-DD /awips2/pypies/logs/pypiesMinuteStats.log.YYYY-MM-DD /awips2/httpd_pypies/var/log/httpd/access_log /awips2/httpd_pypies/var/log/httpd/error_log
DX3/DX4	EDEX	/awips2/edex/logs
	GFE	/awips2/GFESuite/logs/<site>/<yyyymmdd><server>/ingestAT.log /awips2/GFESuite/logs/<site>/<yyyymmdd><server>/irtServer.log /awips2/GFESuite/logs/<site>/<yyyymmdd><server>/iscDataRec.log /awips2/GFESuite/logs/<site>/<yyyymmdd><server>/requestAT.log /awips2/GFESuite/logs/<site>/<yyyymmdd><server>/sendAT.log
	GFE-ServiceBackup	awips2/GFESuite/ServiceBackup/logs/<yyyymmdd>/svcbu_export_g rids_1553
CPSBN1/ CPSBN2	QPID	/awips2/qpid/var/log /var/logs <b>Note:</b> Logs to <i>message</i> log.
	scour	/usr/local/ldm/logs
	LDM	/usr/local/ldm/logs
LX/XT	AlertViz	~/caveData/logs
	CAVE	~/caveData/etc/user/\${USER}/logs

The logs identified in Table P.2-3 provide specific information.

**Table P.2-3. Specific Information for Log Files**

Server	Log	Description
DX3/DX4	edex-ingest-YYYYMMDD.log	General Ingest and Operations Log
DX3/DX4	edex-ingestDat-YYYYMMDD.log	DATIngest and processing log
	edex-ingest-gen_areal_ffg- YYYYMMDD.log	FFG Ingest and processing log
	edex-ingest-gen_areal_qpe- YYYYMMDD.log	QPE Ingest and processing log
	edex-ingestGrib-YYYYMMDD.log	Grib data ingest and processing log
	edex-ingest-purge-YYYYMMDD.log	Data purge log
	edex-ingest-radar-YYYYMMDD.log	Radar data ingest and processing log
	edex-ingest-satellite- YYYYMMDD.log	Satellite data ingest and processing log
	edex-ingest-shef-YYYYMMDD.log	Shef data ingest and processing log
	edx-ingest-shef-performance- YYYYMMDD.log	Shef performance log
	edex-ingest-smartInit- YYYYMMDD.log	GFE SmartInit processing log
edex-ingest-sportlma-	sportlma processing log	

Server	Log	Description
	YYYYMMDD.log	
	edex-ingest-unrecognized-files-YYYYMMDD.log	All data which does not match a distribution pattern XML shows up in this log
	edex-request-YYYYMMDD.log	EDEX Request server log
	edex-request-thriftSrv-YYYYMMDD.log	Most of the requests from CAVE and a few requests from python command line utilities (e.g., some GFE items)
	start-edex-ingest-YYYYMMDD.log	Log created from running service edex_camel start
	start-edex-ingestGrib-YYYYMMDD.log	Log created from running service edex_camel start
	start-edex-ingestDat-YYYYMMDD.log	Log created from running service edex_camel start
	start-edex-request-YYYYMMDD.log	Log created from running service edex_camel start
	edex-ingest-archive-YYYYMMDD.log	Ingest Archive log
	edex-ingest-GFEPeformance-YYYYMMDD.log	GFE Performance Ingest log
	edex-ingest-activeTableChange-YYYYMMDD.log	activeTableChange logs
	edex-ingestDat-activeTableChange-YYYYMMDD.log	ingestDat activeTableChange logs
	edex-ingestDat-performance-YYYYMMDD.log	IngestDat Performance logs
	edex-ingestGrib-activeTableChange-YYYYMMDD.log	Ingest Grib activeTableChange log
	edex-request-activeTableChange-YYYYMMDD.log	EDEX request activeTableChange log
	edex-ingest-performance-YYYYMMDD.log	EDEX ingest performance log
	edex-request-performance-YYYYMMDD.log	EDEX request performance log
	edex-ingest-gen_areal_qpe-YYYYMMDD.log	EDEX ingest QPE log
	edex-request-GFEPeformance-YYYYMMDD.log	GFE Performance Request Log
	edex-request-hibernate-YYYYMMDD.log	EDEX request Hibernate Log (See note below.)
	edex-ingest-hibernate-YYYYMMDD.log	EDEX ingest Hibernate Log (See note below.)
	edex-ingestGrib-hibernate-YYYYMMDD.log	EDEX ingestGrib Hibernate log (See note below.)
	edex-ingestDat-hibernate-YYYYMMDD.log	EDEX ingestDat Hibernate log (See note below.)
	edex-ingest-ohd-YYYYMMDD.log	ohd log
DX3	configureTextProducts-20150512.log	Text Products Configuration log
dx1f	radarserver.log	RCM process log
	postgresql-YYYY-MM-DD-HHMMSS.log	PostgreSQL log (new log started on new day and on server restart).

Server	Log	Description
	access_log	httpd-pypies access log
	error_log	httpd-pypies error log
dx2f	pypies.log	pypies process log
CPSBN1/2	ldmd.log	LDM log
	nwstg.log	readnoaaport for NWSTG feed log
	nwstg2.log	readnoaaport for NWSTG2 feed log
	goes.log	readnoaaport for GOES feed log
	oconus.log	readnoaaport for Outside Conterminous United States (OCONUS) feed log
	goes_add.log	Additional GOES log
	qpidd.log	QPID
LX/XT	\$(hostname).alertviz.log	AlertViz Start Log
	\$(hostname)_caveConsole.log	CAVE stdout messages that would normally be seen in the console window if you ran cave.sh
<p><i>Note: The hibernate log file will now be produced for each EDEX instance. Any errors produced by org.hibernate will be logged to this file. This log file should primarily be referenced whenever there are persistence errors in the EDEX instance logs.</i></p>		

**Known Error Messages.** Not all error messages can be listed ahead of the time that they will be seen, nor can it be foretold that one will show up when you are expecting it. However, a list of previously identified messages and what they mean follows.

### PostgreSQL Errors

```
FATAL: no pg_hba.conf entry for host "165.92.24.3", user "awips", database
"dc_ob7mhx"
```

This error indicates that some process is attempting to make a database connection from host 165.92.24.3 to database dc\_ob7mhx as database user *awips*. The rules for defining this access are in the /awips2/data/pg\_hba.conf. If this file does not have an entry granting host access to this IP address, the error will be seen.

```
FATAL: the database system is starting up
```

This error indicates that some process is attempting to make a connection to the database engine while it is starting and before it is ready. This may happen if the engine was not stopped cleanly, and is in the process of replaying transactions logs to recover lost data.

### LDM

```
ERROR: Could not connect to the remote EDEX instance.
```

This error shows that the LDM processes could not connect to the QPID JMS server through the edexBridge executable.

### EDEX

```
[EDEXMain] GFESiteActivation: GFE: GFESiteActivation - OAX Error activating site OAX
due to configuration
```

This error shows that GFE activation failed on the server side, meaning that no GFE



clients will be able to connect for the failed site. This particular error shows the problem to be with the configuration, which would be the `siteConfig.py` or `localConfig.py` file.

`RPGEEnvironmentalDataManager: RPGEEnvData - Error connecting to RadarServer`

The EDEX processes are those that will send the necessary environmental data to the ORPG. This operation is performed through the RCM process running on `dx1f`. If EDEX cannot connect to the RCM process, this error will show in the EDEX logs.

**Note:** Do not add declarations to `localConfig.py` that override system variables. Now that GFE processing has been incorporated into EDEX, these declarations could negatively affect the behavior of multiple systems. For example, do not set TZ inside `localConfig.py` as it will have an adverse effect of the behavior of WarnGen.

### ***P.3 AWIPS II System Monitor***

The AWIPS II system monitor has been changed as a result of the changes made in how data is stored and retrieved with AWIPS I. In order to keep the two separate, the AWIPS II system monitor will run from the apache default `/etc/httpd` directory on the server hosting the `a2px1apps` package. Note that the location of the http server will not change. Also staying the same will be the URL to the system monitor, <http://px1f>. This means that the AWIPS I bookmark will still be used. The look, however, has been changed to a more readable design as shown in Exhibit P.3-1.

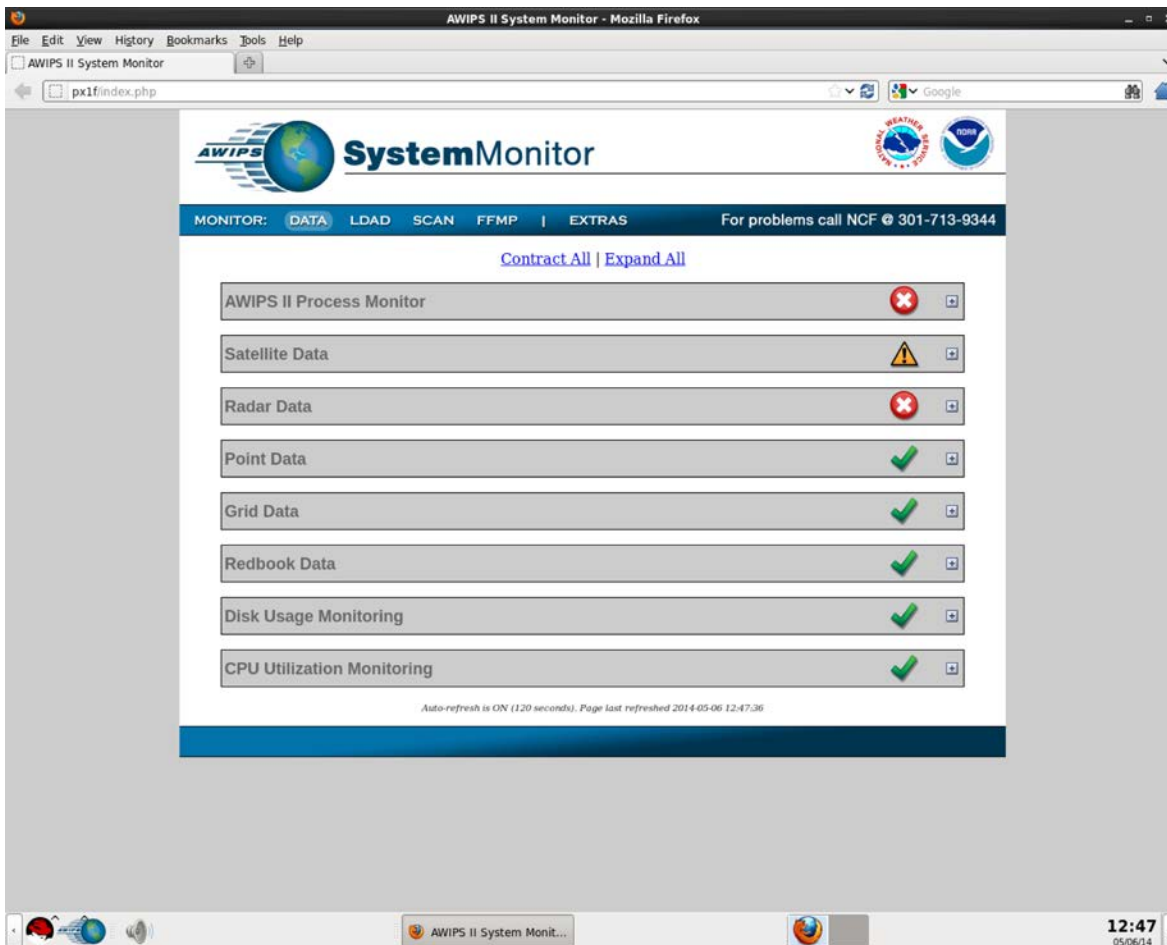

**Exhibit P.3-1. AWIPS II System Monitor**

The AWIPS II system monitor leverages the notion that each data piece has a metadata entry within the database. It works on a timed refresh, which means it is no longer dependent on individual collection processes. This benefits the system because individual processes could fail or crash, causing data not to update. It is also a good indication of how things are behaving within the system. For example, CAVE also uses the metadata to populate the most recent product time for each of the menu entries. So, if the AWIPS II System Monitor is showing stale or missing data, it should be showing stale or missing information in the CAVE menus as well. One difference between how the system monitor and CAVE get these times is that the AWIPS II System Monitor page pulls directly from the database, while CAVE uses requests through EDEX. This is a good troubleshooting tool to use in order to isolate any problems with CAVE's connection to EDEX, or problems with the underlying backend.

While data monitoring is no longer dependent on individual processes, disk and CPU monitoring are still done via script, which kicks off via the root crontab associated with the a2px1apps package. The crons are set up in the a2px1cron file which will be active in the /etc/cron.d directory when the package is started. Table P.3-1 lists the cron entries.

**Table P.3-1. AWIPS II System Monitor Cron Entries**

<b>cron to update disk monitor portion of the AWIPS II System Monitor</b>	
* / 20 * * * *	root /data/fxa/A2_SysMonitor/scripts/diskMon.sh >> /dev/null
* / 20 * * * *	root /data/fxa/A2_SysMonitor/scripts/ldad_diskMon.sh >> /dev/null
<b>cron to update CPU monitor portion of the AWIPS II System Monitor</b>	
* / 20 * * * *	root /data/fxa/A2_SysMonitor/scripts/cpuMon.sh >> /dev/null
* / 20 * * * *	root /data/fxa/A2_SysMonitor/scripts/ldad_cpuMon.sh >> /dev/null

The scripts in Table P.3-1 create an actual php file that is viewable through a link on the system monitor page. This shows the CPU utilization on the various devices. Notice that the stdout of the scripts is sent to /dev/null, which means if the disk or CPU Utilization is not working it might be useful to run one of these scripts via the command line to see if there is extra information provided to stdout which might help isolate any problems.

Configuration files that help customize the data monitoring and refresh are xml files stored in /data/fxa/A2\_SysMonitor/config. Each piece of the system monitor can be configured by manipulating the delivered xml files. These files are listed in Table P.3-2.

**Table P.3-2. AWIPS II System Monitor Configuration Files**

<b>Data Set</b>	<b>Configuration File Name</b>
Redbook Graphics Monitoring	graphic.xml
Grid Data Monitoring	grid.xml
LDAD Acquisition Data	ldad_acq.xml
LDAD Dissemination	ldad_dissem.xml
LDAD Processes	ldad.xml
General System Monitor Parameters	params.xml
Point Data Monitoring	point.xml
Radar Data Monitoring	radar.xml
Satellite Data Monitoring	satellite.xml

Exhibit P.3-2 illustrates one of the configuration files, radar.xml. It is noted that there is site-specific data that should be filled in during the installation of the AWIPS II software.

```
<radar>
<data>
  <productname>8-Bit Base Reflectivity (Z) elev0_5</productname>
  <sqltxt>SELECT reftime FROM radar WHERE productcode = '94' AND
location_rda_id = 'RADAR_ID' AND primaryelevationangle = '0.5' ORDER BY
reftime DESC LIMIT 1</sqltxt>
  <warnthresh>720</warnthresh>
  <errorthresh>1440</errorthresh>
</data>
</radar>
```

**Exhibit P.3-2. Radar.xml Configuration File**

In the case of the radar file in Exhibit P.3-1, the text in the **<productname>** **</productname>** tags are what is shown in the Radar Product portion as seen in Exhibit P.3-3.





Radar Data 		
Radar Product	Last Update	Status
KOAX Base Reflectivity (Z) elev0_5	2011-05-31 20:39:45.038	

Exhibit P.3-3. Radar Product

The `<sqltxt>` tags enclose the SQL (Structured Query Language) statement used to pull the most recent product from the appropriate metadata table. In this case, it is selecting from the radar table.

The `<warnthresh>` is the time in seconds before the yellow  is shown in the Status column. In this example, 12 minutes old.

The `<errorthresh>` is the time in seconds before the red  is shown in the Status column. In this example, 24 minutes old.

To add a new entry, a full new `<data>` section between `<radar>` and `</radar>` tags will need to be added. The way the xml is configured, however, provides added flexibility into which data products are monitored and what each threshold will be for the alarms.

Similarly, data can be configured and added in the other configuration files listed in Table P.3-2. Table P.3-3 describes the tags used in each.

Table P.3-3. AWIPS II System Monitor Configuration Files Tags

XML Tag	Tag Description
<i>ffmp_grids.xml</i>	
<code>&lt;rfc&gt;</code>	A valid 3-letter River Forecast Center (RFC) AWIPS Identifier
<code>&lt;errorthresh&gt;</code>	The number of seconds before the data is shown as missing
<i>ffmp_radar.xml</i>	
<code>&lt;rda&gt;</code>	A valid 4-letter radar identifier
<code>&lt;errorthresh&gt;</code>	The number of seconds before the data is shown as missing
<i>graphic.xml</i>	
<code>&lt;productname&gt;</code>	Text to describe the product being monitored
<code>&lt;sqltxt&gt;</code>	A valid SQL query which returns the most recent inserttime of the product being monitored
<code>&lt;warnthresh&gt;</code>	The number of seconds before the data is shown as late
<code>&lt;errorthresh&gt;</code>	The number of seconds before the data is shown as missing
<i>grid.xml</i>	
<code>&lt;productname&gt;</code>	Text to describe the product being monitored
<code>&lt;sqltxt&gt;</code>	A valid SQL query which returns the most recent inserttime of the product being monitored
<code>&lt;warnthresh&gt;</code>	The number of seconds before the data is shown as late
<code>&lt;errorthresh&gt;</code>	The number of seconds before the data is shown as missing
<i>ldad_acq.xml</i>	
<code>&lt;productname&gt;</code>	Text to describe the product being monitored

XML Tag	Tag Description
<filename>	The full path, including file name, of the file to be monitored for punctuality on the LDAD server
<warnthresh>	The number of seconds before the data is shown as late
<errorthresh>	The number of seconds before the data is shown as missing
<i>ldad_dissem.xml</i>	
<productname>	Text to describe the product being monitored
<filename>	The full path, including file name, of the file to be monitored for proper dissemination on the LDAD server
<warnthresh>	The number of seconds before the data is shown as late in being disseminated
<errorthresh>	The number of seconds before the data is shown as missing
<i>ldad.xml</i>	
<processname>	The name of a process to monitor
<host>	Where the process normally runs
<i>point.xml</i>	
<productname>	Text to describe the product being monitored
<sqltxt>	A valid SQL query which returns the most recent reftime of the product being monitored
<warnthresh>	The number of seconds before the data is shown as late
<errorthresh>	The number of seconds before the data is shown as missing
<i>radar.xml</i>	
<productname>	Text to describe the product being monitored
<sqltxt>	A valid SQL query which returns the most recent inserttime of the product being monitored
<warnthresh>	The number of seconds before the data is shown as late
<errorthresh>	The number of seconds before the data is shown as missing
<i>satellite.xml</i>	
<productname>	Text to describe the product being monitored
<sqltxt>	A valid SQL query which returns the most recent inserttime of the product being monitored
<warnthresh>	The number of seconds before the data is shown as late
<errorthresh>	The number of seconds before the data is shown as missing
<i>scan_radar.xml</i>	
<rda>	A valid 4-letter radar identifier
<errorthresh>	The number of seconds before the data is shown as missing

### P.3.1 System Monitor Main Configuration File

The AWIPS II System Monitor has one main configuration file which also resides in the /data/fxa/A2\_SysMonitor/config directory structure. The name of the file is params.xml and is shown in Exhibit P.3.1-1.

```

<params>
  <config>
    <dbserver>dx1f</dbserver>
    <edexserver>dx3</edexserver>
    <dbuser>awips</dbuser>
    <dbpass>awips</dbpass>
    <refresh>120</refresh>
    <ldad_refresh>600</ldad_refresh>
    <scan_refresh>120</scan_refresh>
    <ffmp_refresh>120</ffmp_refresh>
    <edex_home>/awips2/edex</edex_home>
    <common_base>/data/utility/common_static/base</common_base>
    <common_site>/data/utility/common_static/site</common_site>
    <monitor_plugin>/monitoring/MonitorPluginState.xml</monitor_plugin>
    <has_ldad>yes</has_ldad>
    <root_dir>/data/fxa/A2_SysMonitor</root_dir>
  </config>
</params>

```

**Exhibit P.3.1-1. params.xml Configuration File**

The values shown in the exhibit are the *baselined* configuration values. They should not change very often, if at all. It is not recommended that this file be changed by the sites; however, a description of the XML tags is provided in Table P.3.1-1.

**Table P.3.1-1. AWIPS II System Monitor params.xml XML Definition**

XML Tag	Description
<dbserver>	The server upon which the PostgreSQL database engine runs
<primary_edex>	The hostname of a server running EDEX
<client_edex>	OBE parameter
<dbuser>	The database user as whom to connect to the PostgreSQL database
<dbpass>	The password for the configured <dbuser>
<refresh>	How often, in seconds, the main page auto-refreshes
<ldad_refresh>	How often, in seconds, the LDAD page auto-refreshes
<scan_refresh>	How often, in seconds, the SCAN page auto-refreshes
<ffmp_refresh>	How often, in seconds, the FFMP page auto-refreshes
<edex_home>	The directory into which the EDEX software is installed
<common_base>	The base directory into which the common configuration localization tree is stored
<monitor_plugin>	The path under common_base to find the plugin state of EDEX
<has_ldad>	yes if the site has an LDAD, no if it does not
<root_dir>	The root directory of the AWIPS II System Monitor

**Appendix Q**  
**AWIPS Applications and Version Numbers**

This appendix identifies the AWIPS applications and their correct version numbers. Please refer to Appendix U for the component categorization.

### AWIPS Applications and Version Numbers

AWIPS Application	Version for Release	Description
Aviation Forecast Preparation System (AvnFPS)	16.2.2	AvnFPS is designed to ease monitoring, improve production, and facilitate Quality Control (QC) of Terminal Aerodrome Forecasts (TAF) and Transcribed Weather Enroute Broadcasts (TWEB). The AvnFPS monitoring capability gives forecasters quick and continuous feedback on TAFs as well as associated observations. This monitoring capability consists of a color-coded scheme and is site configurable. The TAFs, surface observations, and guidance are easily accessible in text or graphical form and can be enhanced to alert forecasters to weather significant to aviation operations.
AWIPS Decision Assistance and Production Preparation Tools (ADAAPT)	16.2.2	ADAPPT Foundation software is composed of the foundation routines that support the IFPS, LAMP, Pre-LAMP, and SCAN.
Broadcast Message Handler	16.1.3-V3	BMH allows users at each WFO to create, process, and distribute messages that include weather observations and forecasts; watches, warnings and advisories, and hazards information. The AWIPS-II system simultaneously accepts text, digitized voice, live voice, and other data from authorized sources. Capabilities include: <ul style="list-style-type: none"> <li>• County codes processing,</li> <li>• Specific Area Message Encoding (SAME) and alert tones activation,</li> <li>• Text-to-speech synthesis,</li> <li>• Interrupt messages including Emergency Override and Live Voice Broadcast.</li> </ul>
Boundary Drawing Tool	16.2.2	Boundary Tool allows the forecaster to add new surface boundaries, adjust the positions of existing boundaries, set a stationary boundary to motion, modify the speed of a moving boundary or end an active boundary.



AWIPS Application	Version for Release	Description
CLIMATE	16.2.2	<p>The CLIMATE software provides the capability to automatically initiate (three times daily) daily, monthly, seasonal, and annual climate reports. It also formats these reports for dissemination (similar to HWR).</p> <p>CLIMATE also provides review and edit capability for products prior to dissemination.</p>
Damage Path Tool	16.2.2	<p>The Damage Path tool allows users to create a polygon to outline a damage path caused by a storm. When initially loading the Damage Path tool, a default polygon displays. Users may edit the location of the vertices as well as move the entire polygon by clicking and holding MB1 on a vertex or polygon and dragging the vertex or polygon to another location.</p>
Dam Catalog Reviewer and Estimating Tool (DamCREST)	OB9	<p>A Graphical User Interface application available on both Linux and Windows operating platforms.</p>
Distributed Hydrologic Modelling (DHM)	OB9	<p>DHM is the set of features integrated into NWSRFS for distributed hydrologic modeling.</p>
Ensemble	16.2.2	<p>The Ensemble Tool provides capabilities to display and manipulate ensemble model data. The datasets and the Tool are there to help forecasters assess uncertainty in the forecast, or lack thereof. This is intended to assist forecasters with interactive decision support in two ways: estimates of event probability, and alternative scenarios to the official (deterministic) forecast.</p>
Flash Flood Monitoring Program: Advanced (FFMPA)	16.2.2	<p>An integrated suite of multi-sensor applications that detects, analyzes, and monitors precipitation and generates short-term warning guidance for flash flooding automatically within AWIPS.</p>

AWIPS Application	Version for Release	Description
Fog Monitor (FM).	16.2.2	<p>An AWIPS application that applies various algorithms to visible and infrared satellite images in order to identify potential areas of fog. At night, the application primarily uses the well-known infrared "Fog Product" (the difference of the 10.7 micron and 3.9 micron brightness temps) to highlight potential fog areas. During the daytime, several algorithms attempt to discern fog areas by brightness, shape, and other characteristics.</p> <p>Also applied are filters that help to distinguish fog from possible false signal features such as snow cover and mid-level clouds.</p>
Four-dimensional Stormcell Investigator (FSI)	0.4	<p>An innovative base radar data 4-panel display application that is based on the National Severe Storms Laboratory Warning Decision Support System - Integrated Information GUI. FSI allows users to create and manipulate dynamic cross-sections (both vertical and at constant altitude), so that they can "slice and dice" storms and view these cross-section data in three-dimensions and across time.</p>
Gridded Forecast Environment Suite (GFE Suite)	16.2.2	<p>A series of programs that provide an interactive gridded forecast preparation capability. Components derive surface sensible weather elements from model data, manage the forecast data and metadata in a database, and generate forecast products in a variety of formats.</p>
Hourly Weather Roundup (HWR)	Version 05/18/05	<p>HWR automatically receives and processes METAR surface observations, Satellite Cloud Products (SCP), Supplementary Climatological Data (SCD), and marine observations. It also formats a text portion of the data for dissemination over NWR, a text portion for the Console Replacement System (CRS), and a tabular product for dissemination over NWWS. Furthermore, the HR CSCI provides review and edit capability for products prior to dissemination.</p>

AWIPS Application	Version for Release	Description
Hydro Database Manager (HydroBase)	16.2.2	HydroBase is the component of the AWIPS system that permits the management of the reference portion of the database. Adding, deleting, and editing of hydrometeorological data collection and river forecast data locations are handled within this application. It consists of a series of pull-down menus that allow for interacting with the information within the reference database.
HydroGen	OB9	HydroGen is a suite of software programs that collect data from the Integrated Hydrologic Forecast System (IHFS) database and prepare eXtensible Markup Language (XML) files and hydrograph graphics (or simply “hydrographs”) for the web.
HydroView  MPE_Editor	HydroView: 16.2.2  MPE_Editor: 16.2.2	HydroView and MPE Editor have been reengineered into a CAVE and other CAVE plug-ins.
Interactive Forecast Preparation System (IFPS)	16.2.2	IFPS enables the forecaster to generate and manipulate a digital database of observed and forecasted meteorological variables, which then can be used to automatically generate various products with different formats.
Localized Aviation MOS Program (LAMP)	OB8.2	A statistical system that provides forecast guidance for sensible weather elements. The GFS-LAMP guidance currently runs operationally at NCEP. Guidance is available from the following cycles: 0000, 0300, 0600, 0900, 1200, 1500, 1800, and 2100 UTC
Local Analysis and Prediction System (LAPS)	OB9	Reads METAR, mesonet, satellite, radar, and profiler data stored at the WFO and performs an analysis and generates forecasts.
Local Data Acquisition and Dissemination (LDAD)	OB9	The LDAD software system acquires and integrates data available from automated systems and human observers in the local WFO area. It also disseminates critical and non-critical AWIPS weather information to local users, particularly state and local government emergency management agencies.

AWIPS Application	Version for Release	Description
Local Storm Report (LSR)	16.2.2	A stand-alone AWIPS application designed to provide forecasters with an easy and quick way to create, manage, and send the LSR public text product. This text product contains noteworthy weather events for which the forecaster has either received or sought real-time observations.
NOAA Weather Radio With All-Hazards VTEC Enhanced Software (NWRWAVES)	Browser: Version 9.7 (12/15/08)	Developed to replace all the existing formatter capabilities in WWA and CAFE. NWRWAVES utilizes VTEC coding found in an increasing suite of NWS products to better identify, produce and manage outbound CRS Weather Messages.
NWS River Forecast System (NWSRFS)	OB9  OB8.3(01/02/08) OB8.3(01/02/08) OB8.3(01/02/08)	A comprehensive set of hydrologic techniques used by the RFCs to perform their forecast functions.
RFC Archive Server (RAX)	OB6  OB8.3 (02/01/08) OB8.3 (02/01/08) OB8.3 (02/01/08) OB8.3 (02/01/08) OB8.3 (02/01/08)	The RAX CSCI is a member of the Data Server (DS) family but is a stand-alone Linux PC at the RFCs. The RAX CSCI is dedicated to providing additional disk storage capability and processing power to the RFCs for hydrological data.
River Product Formatter (RiverPro)	OB9.2.9 (07/01/2010)	RiverPro application, which generates text products for the National Weather Service Hydrology program.
RiverMonitor	OB8.3 (03/18/07)	Used to provide automatically updated tabular information summarizing river conditions. Delivered in part for RiverPro VTEC monitoring; provides general monitoring of river data.
System for Convection Analysis and Nowcasting (SCAN)	16.2.2	An integrated suite of multi-sensor applications that detects, analyzes, and monitors convection and generates short-term probabilistic forecast and warning guidance for severe weather automatically within AWIPS.

AWIPS Application	Version for Release	Description
System for Nowcasting of Winter Weather (SNOW)	16.2.2	An AWIPS application suite that continuously monitors surface observations for winter weather hazards. SNOW automatically alerts the forecasters whenever such conditions are detected, and provides capabilities to display observed winter weather threats in ways that help forecasters focus on what they consider most important.
System on AWIPS for Forecasting and Evaluation of Seas and Lake (SAFESEAS)	16.2.2	A set of AWIPS applications that continuously monitor marine and adjacent overland conditions for specific marine weather hazards. SAFESEAS automatically alerts the forecasters whenever such conditions are detected, and provides capabilities to display observed marine threats in ways that help forecasters focus on what they consider most important.
Warning Generation (WarnGen)	16.2.2	WarnGen enables you to issue flash flood, severe thunderstorm, tornado, and other short-term warnings for a single storm or a line of storms. In addition, you can issue text products (follow-up statements) that update the progress of the storm, cancel the warning if conditions change, re-issue another warning on the same storm, or note the expiration of the warning. WarnGen also enables you to provide warning backup support to neighboring sites.
AWIPS Archive Server AWIPS Archive Setup AWIPS Archive Compressor CD Burner	Version: AWIPS II	It has Level IV archiving functionality and supports the Weather Event Simulator at the WFOs.
NMAP	OB9	NMAP displays and animates different types of meteorological data on a geographic background. The current version supports overlay of satellite, radar, model, METAR, MOS, and upper-air data. A Motif graphical user interface controls the program functions.
Site Specific Hydrologic Prediction System (SSHPS)	OB8.2 (9/21/07)	A local hydrologic model provided to allow the WFO forecaster to supplement RFC river forecast guidance by generating forecast river stages for fast-response headwater and river basins.

AWIPS Application	Version for Release	Description
Hydro Time Series	16.2.2	A subset of data within an Arc Hydro geodatabase that includes measurement values and the time they were collected. Also includes a description of the properties for a particular type of time series. Tools for visualizing time series have been developed. The tools allow the user to query the Arc Hydro database for time series records related to a particular feature, and plot one or more types of time series related to one or more spatial feature.
Precipitation Processing (PP)	OB9	This is collection of OHD applications which comprise a sub-system. RFC applications and WHFS (WFO Hydrologic Forecast System) applications require precipitation totals for station locations and grids. It is one of the prime considerations used in forecasting river stage. It is also a key indicator of flash flood potential. The processing applications ingest and process station precipitation reports and gridded precipitation data from radar and satellite sensors. The data are stored in the Integrated Hydrologic Forecast System (IHFS) database. They include 10+ applications that are non-interactive. The primary functional areas are the Gage Precipitation Pre-Processor (GPP), Multi-sensor Precipitation Estimator (MPE), and the Hi-Resolution Precipitation Estimator (HPE).
WFO Hydrologic Forecast System (WHFS) and Integrated Hydrologic Forecast System (IHFS) Database	16.2.2	This is a collection of OHD applications which comprise a sub-system. The WHFS/IHFS applications incorporate a comprehensive set of data ingest, data quality, and data processing operations. Associated with each observed and forecast value in the database is a quality control code which indicates the quality of the value based on external and internal tests of the value. Depending on the value of the quality code, the data are handled in different ways within the IHFS data flow and applications may or may not use the data. They contain 10+ applications that are non-interactive, including the SHEF decoder, the database purger, the rate-of-change checker, alert/alarm report generator, observed-forecast monitor, HydroGen data extractor, and SiteSpecific data handling operations.

AWIPS Application	Version for Release	Description
High-resolution Precipitation Estimator (HPE)	16.2.2	HPE provides frequent (by default every 5minutes) high resolution (~1km x 1km) rain rate and 1-hour rain accumulations covering a Weather Forecast Office's (WFO) (or River Forecast Center's (RFC)) area of responsibility. These gridded datasets can then be used by the Flash Flood Monitoring and Prediction Advanced (FFMP-A) system or can be displayed on D2D. The mosaicking uses data from multiple radars minimizing the distance from each radar. As a result, HPE reduces the need to run multiple instances of FFMP when convection covers more than one radar. HPE is an entirely separate program from the Multi-sensor Precipitation Estimator (MPE) and will not replace it. HPE uses different data, produces different output grids more frequently and at higher resolution, and runs with little user interaction.

## **Appendix R**

### **System Architecture Diagrams**



## Appendix R. System Architecture Diagrams

### List of Exhibits

	<i>Page</i>
Exhibit R-1. CONUS WFO Architecture .....	2
Exhibit R-2. OCONUS WFO Architecture .....	3
Exhibit R-3. RFC Architecture .....	4
Exhibit R-4. NCEP Architecture.....	5

This appendix graphically represents the AWIPS software components associated with the various AWIPS hardware components.

- Exhibit R-1 depicts the CONUS WFO architecture.
- Exhibit R-2 depicts the OCONUS WFO architecture.
- Exhibit R-3 depicts the RFC architecture.
- Exhibit R-4 depicts the NCEP architecture.



# CONUS WFO Architecture

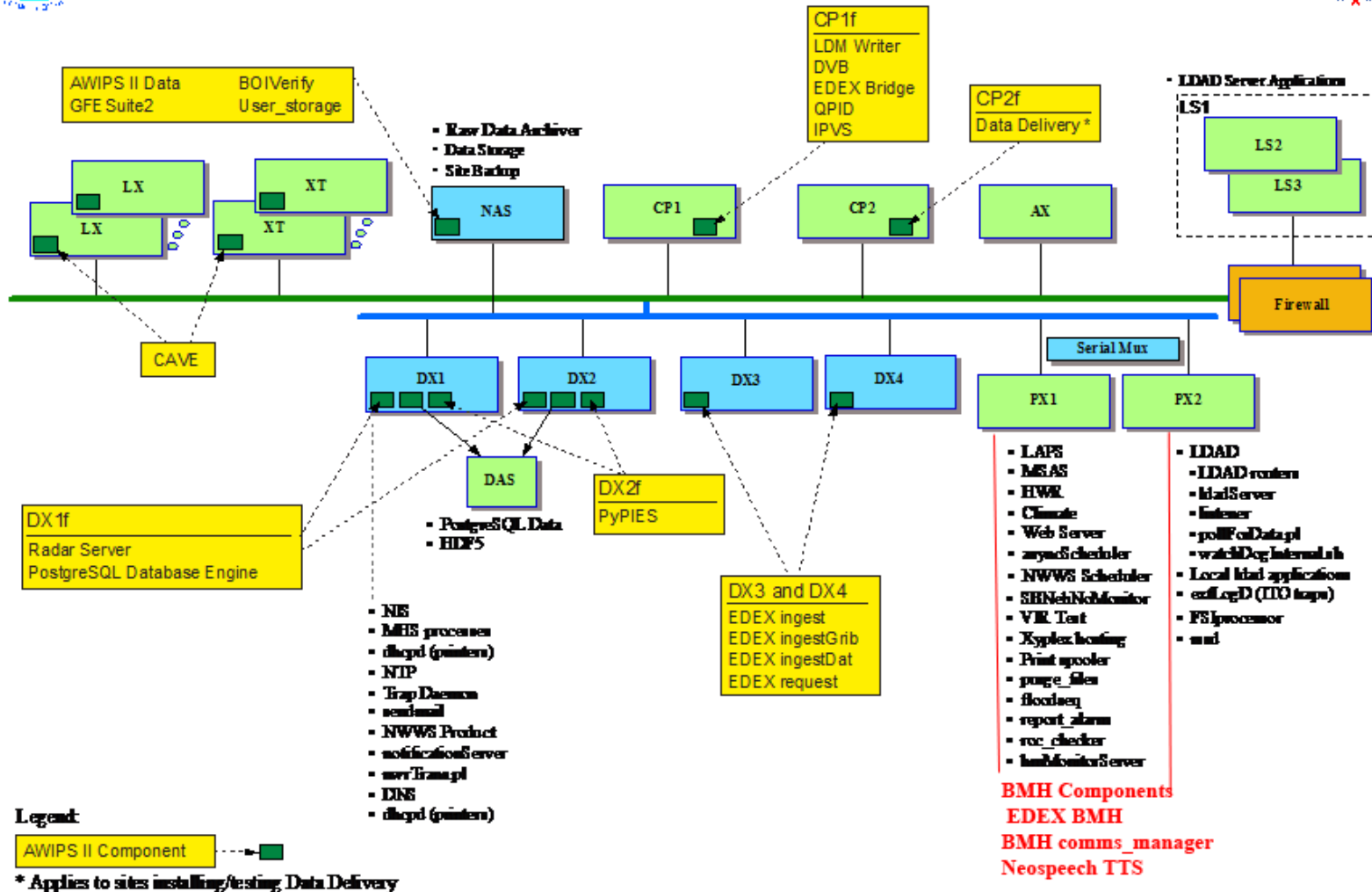

Exhibit R-1. CONUS WFO Architecture



# OCONUS WFO Architecture

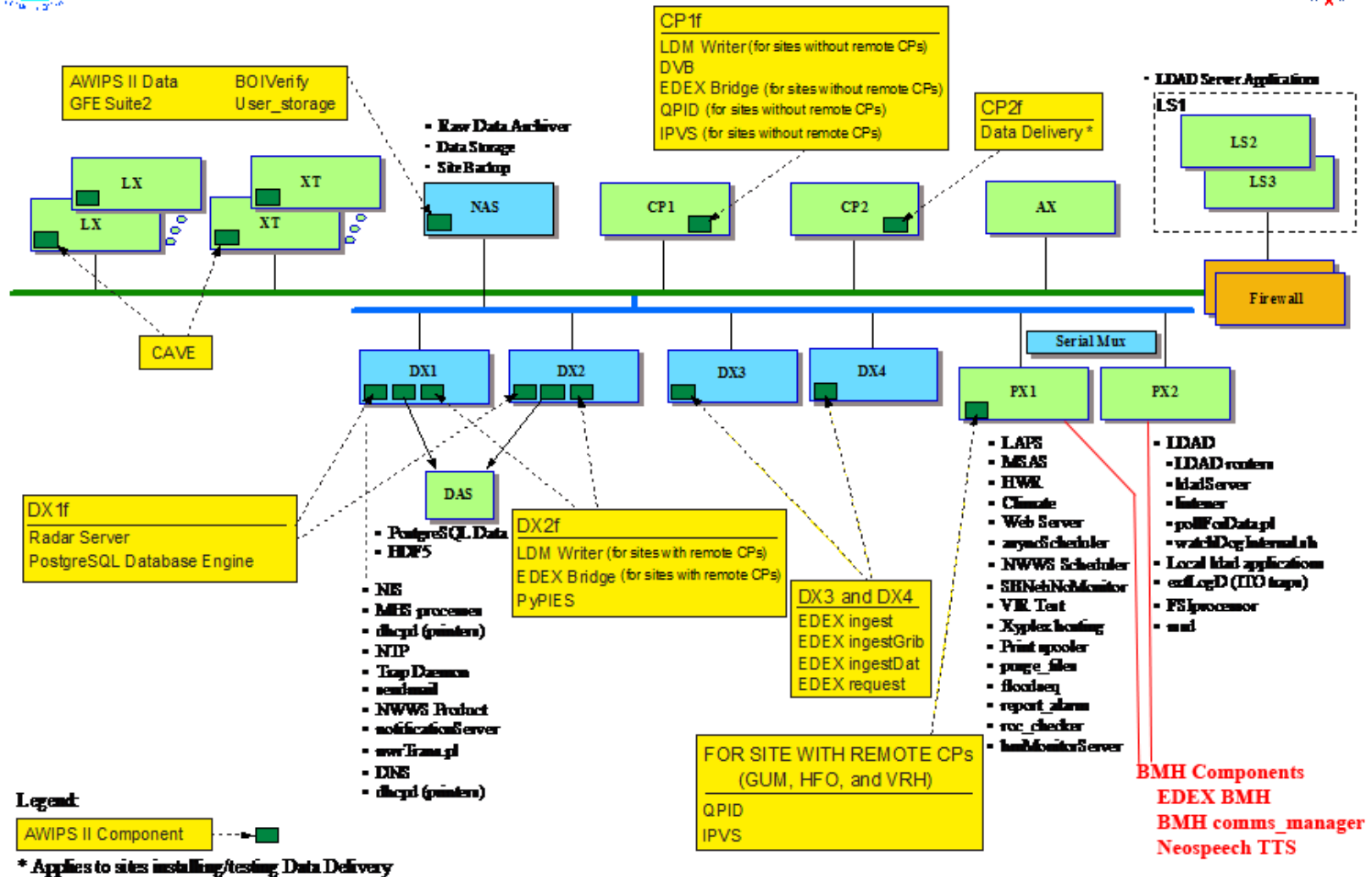
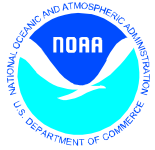
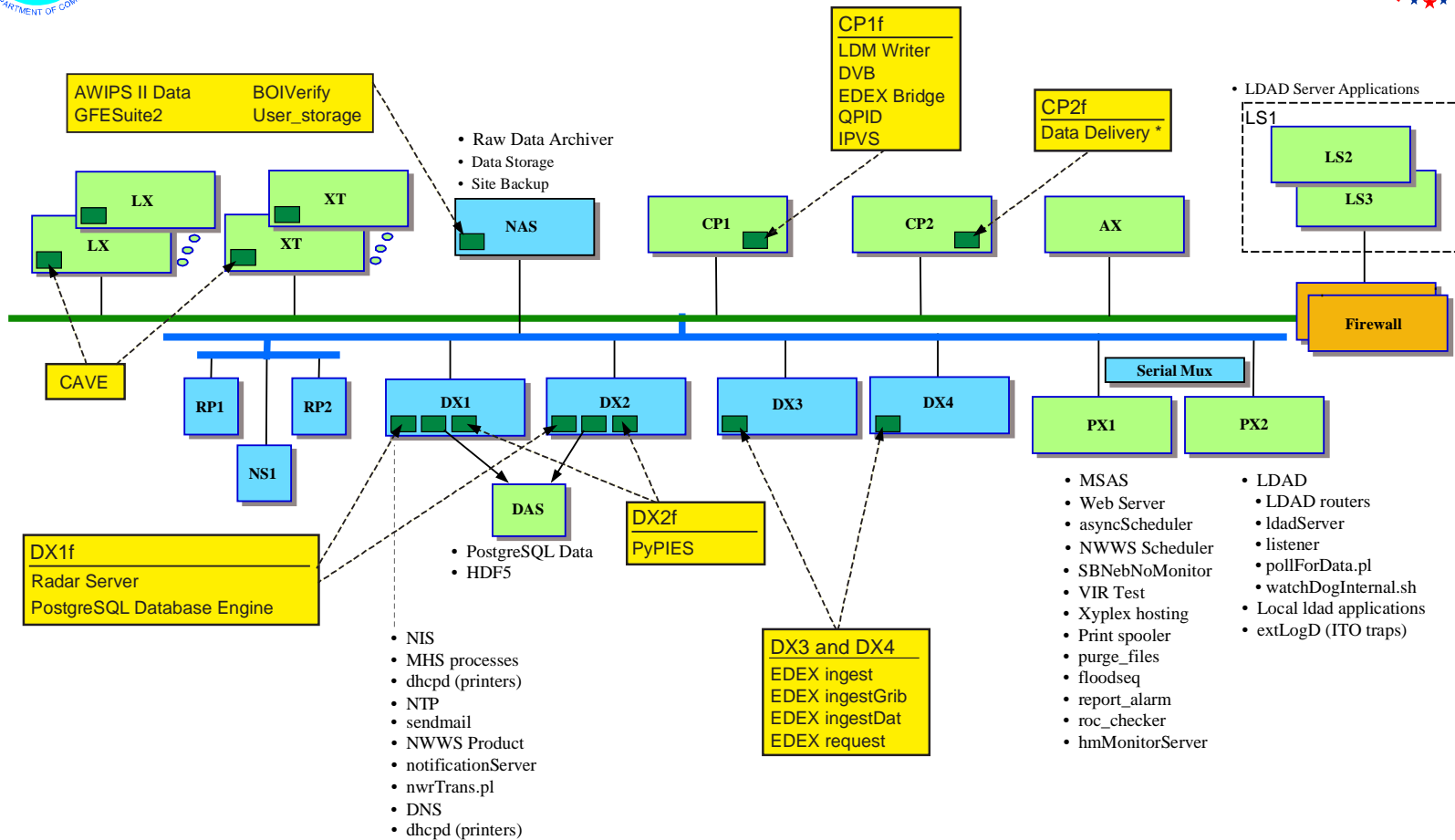

Exhibit R-2. OCONUS WFO Architecture



# RFC Architecture



Legend:



\* Applies to sites installing/testing Data Delivery

SMM\_05/12/2014

**Exhibit R-3. RFC Architecture**

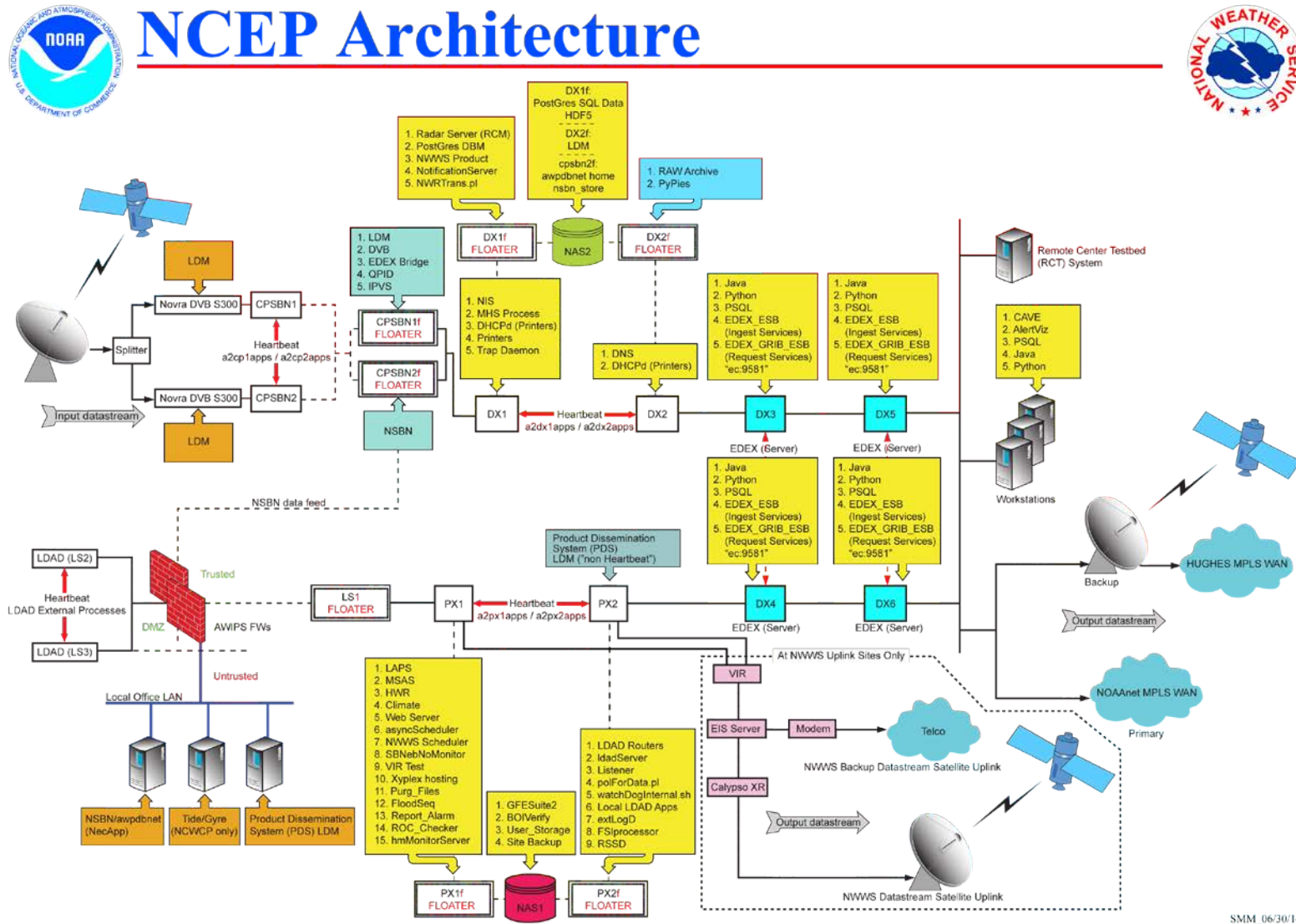

SMM 06/30/14

Exhibit R-4. NCEP Architecture

**Appendix S**  
**CAVE Localization Perspective**

AWIPS II supports a base/site/user localization pattern similar to AWIPS I. In AWIPS II, the localization data is preserved in a Localization Store that is physically mounted on the NAS and is accessible via the EDEX Request process running on the DX3/4 servers. The Localization Store includes configuration for both CAVE and EDEX.

The CAVE Localization Perspective provides a graphical interface to access the CAVE localization data. This perspective provides a familiar file browser interface for locating configuration files. The Localization Perspective also shields the user somewhat from the physical structure of the Localization Store, providing a logical grouping of files by application/perspective (D2D, GFE, etc.), and it enforces access restrictions for editing certain files.

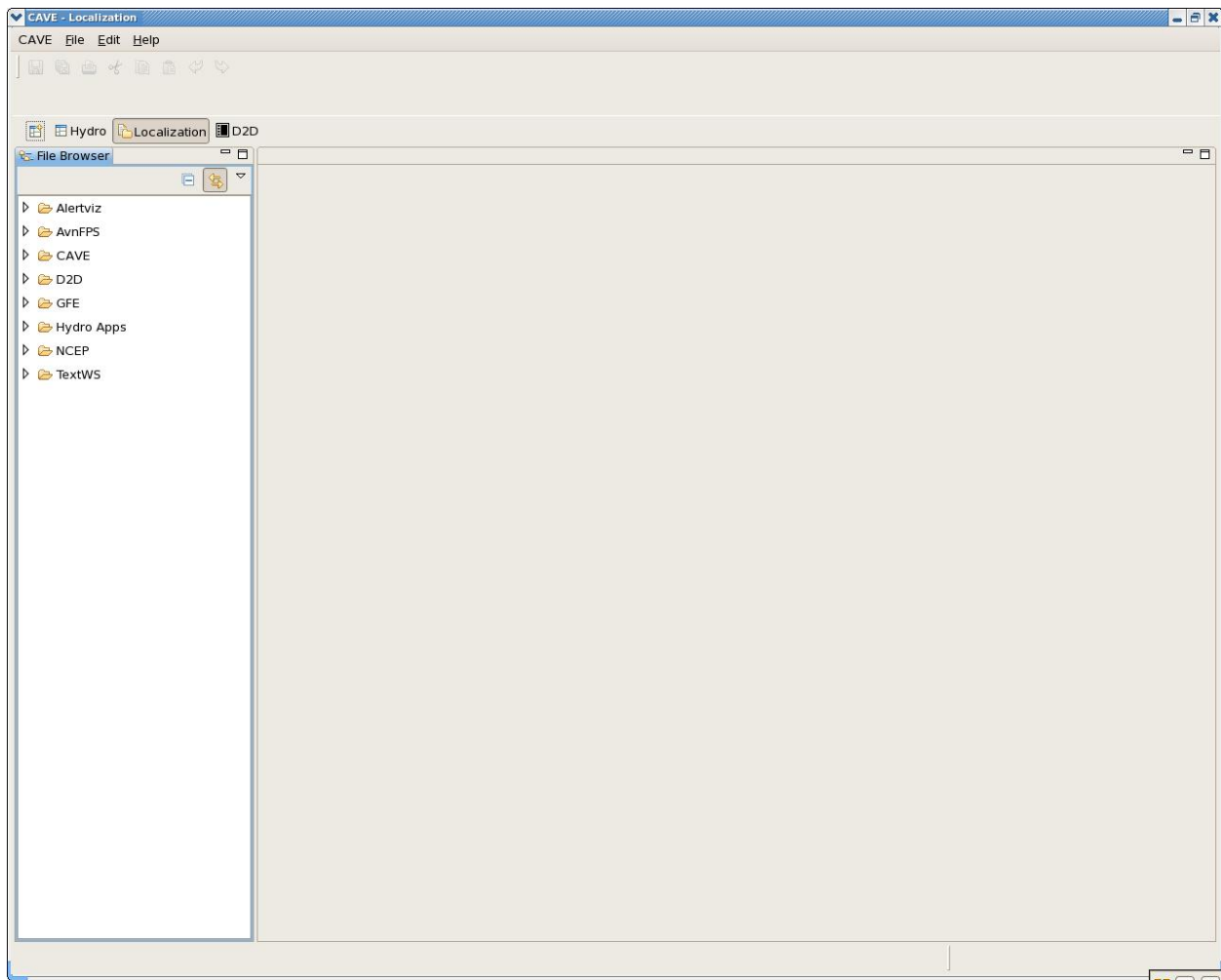

The Localization Perspective contains three views: the *File Browser* view; the *File Editor* view; and the *File Outline* view.

1. The *File Browser* view provides a familiar tree approach to locating a specific configuration file. The configuration files are organized by application (CAVE, D2D, GFE, etc.) and then by function and file name. In AWIPS II, there may be several versions of each file, including BASE, CONFIGURED (GFE only), SITE,



WORKSTATION, and USER. Each of these is listed as a separate entry under the actual file name.

2. The *File Editor* view provides an editor for the selected file. When a configuration file is selected, it opens in an appropriate editor; for example, a Python file is opened in the Python editor, and an XML file is opened in an XML editor.
3. The *File Outline* view provides a hierarchical view of certain files. When available, you can click on an element in the File Outline to select that element in the file.

CAVE is installed on the LX and XT workstations, and is normally started via the desktop application launcher mechanism. On the LX workstations, CAVE is launched in full visualization mode, which allows access to the Localization Perspective; on the XT workstations, CAVE is launched as the Text Workstation, which does not allow access to the Localization Perspective.

This exercise provides basic procedures for using the Localization Perspective.

**Note:** AlertViz must be running on the LX workstation before you can start CAVE; normally AlertViz starts when the user logs into the LX workstation.

1. Open the CAVE Localization Perspective.

CAVE is normally started from the popup Start Menu on the LX workstation. This procedure walks you through the initial startup of CAVE and opening the Localization Perspective.

**Note:** This procedure provides the basic steps for accessing the localization perspective. These steps should be used at the start of each of the remaining procedures.

- a. Log into the LX workstation using your student login.
- b. Start CAVE. First, left click on the LX desktop to display the *Start Menu*.

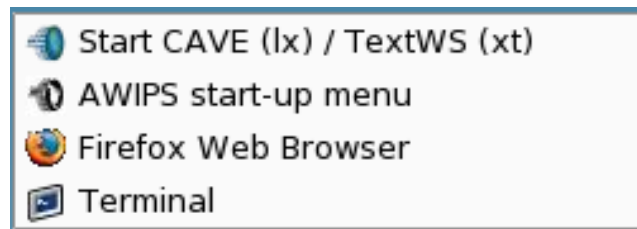

- c. Select 'Start CAVE'.
- d. If CAVE starts correctly, a splash screen will be displayed as CAVE starts.



After a short pause, the main CAVE window will display:

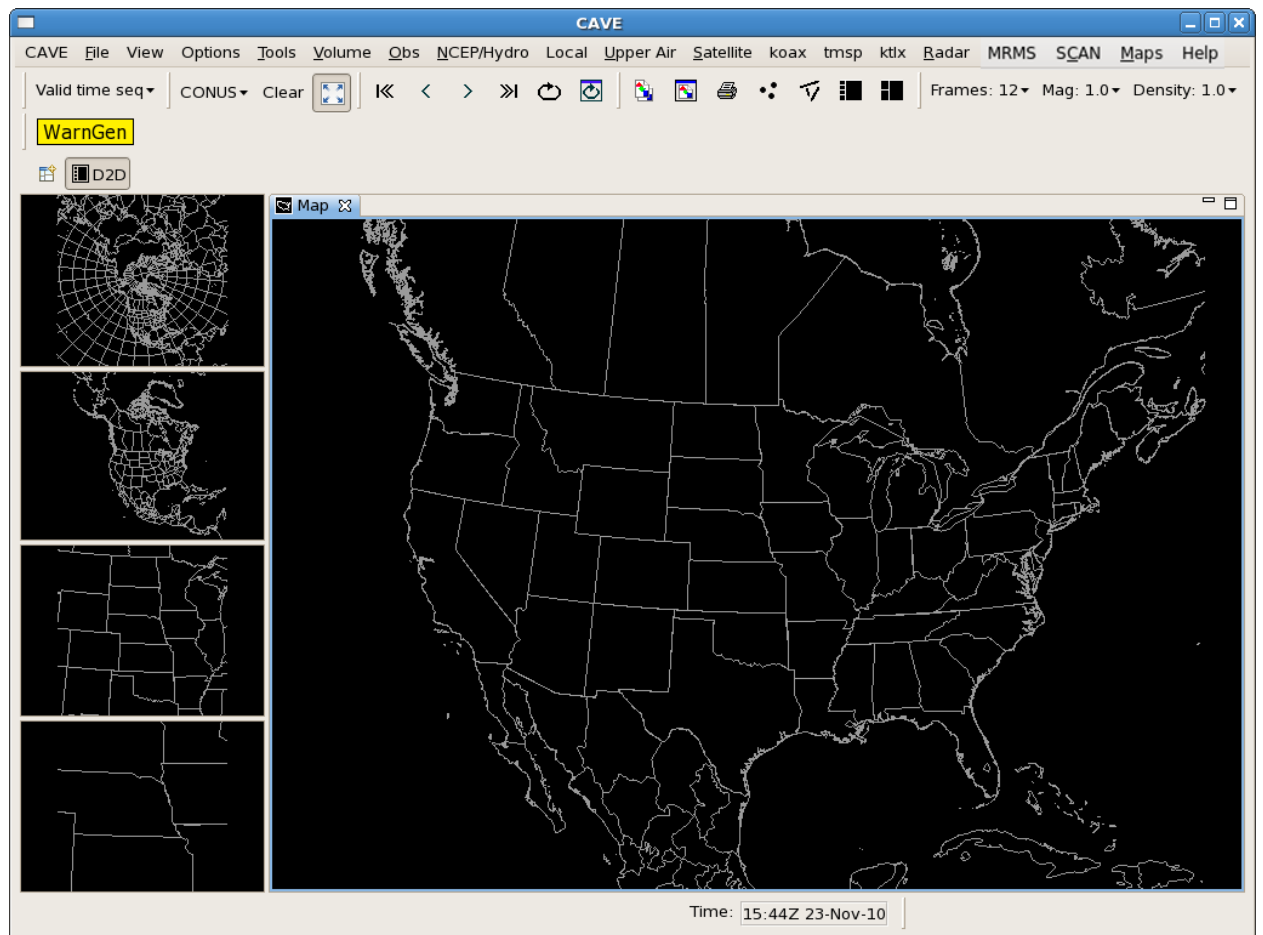

- e. Open the Localization Perspective. First, click the 'perspective' button (to the left of the D2D tab) to display the list of available perspectives.

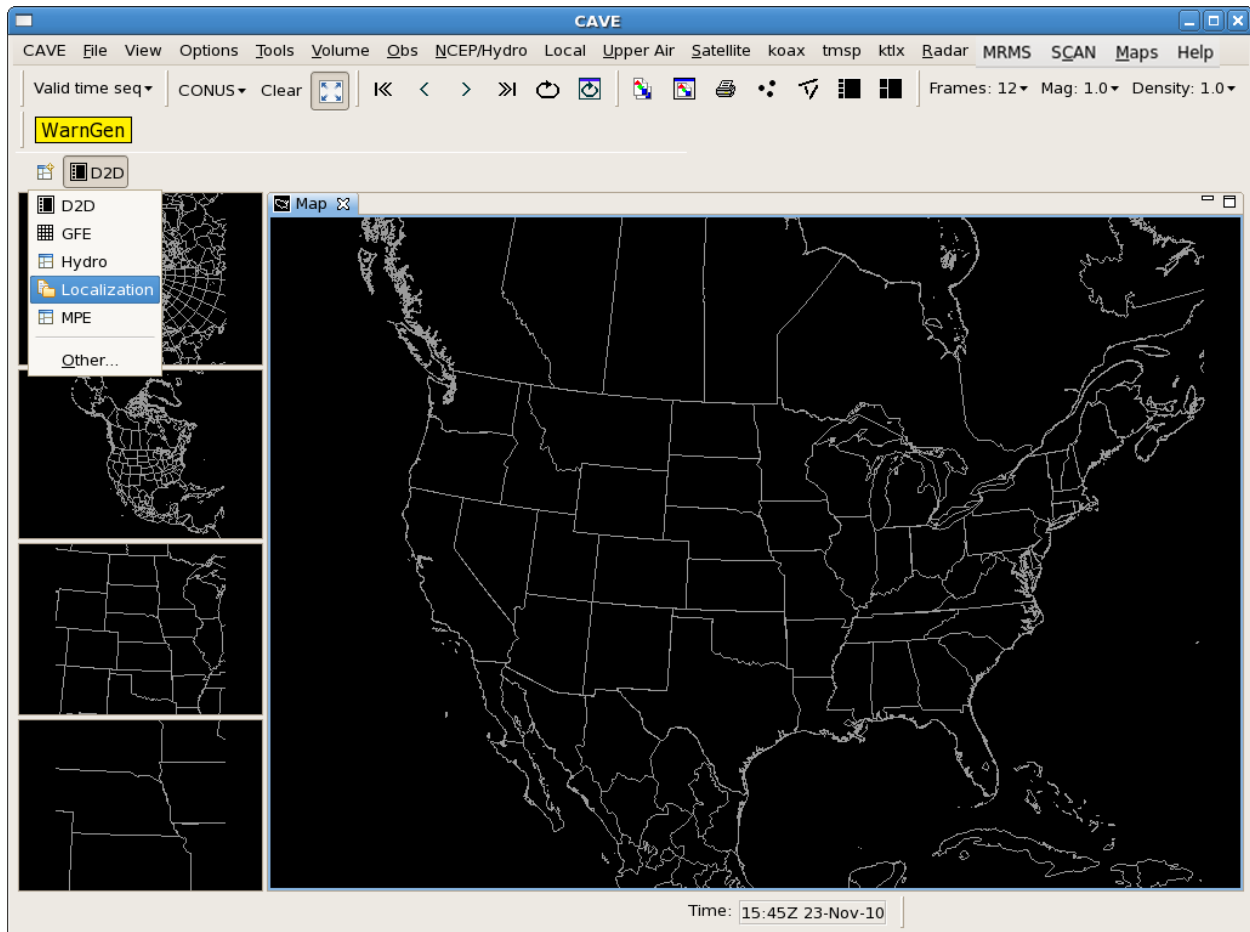

- f. Select 'Localization'.

**Note:** If *Localization* is not listed, select 'Other...' to open the *Open Perspective* dialog.

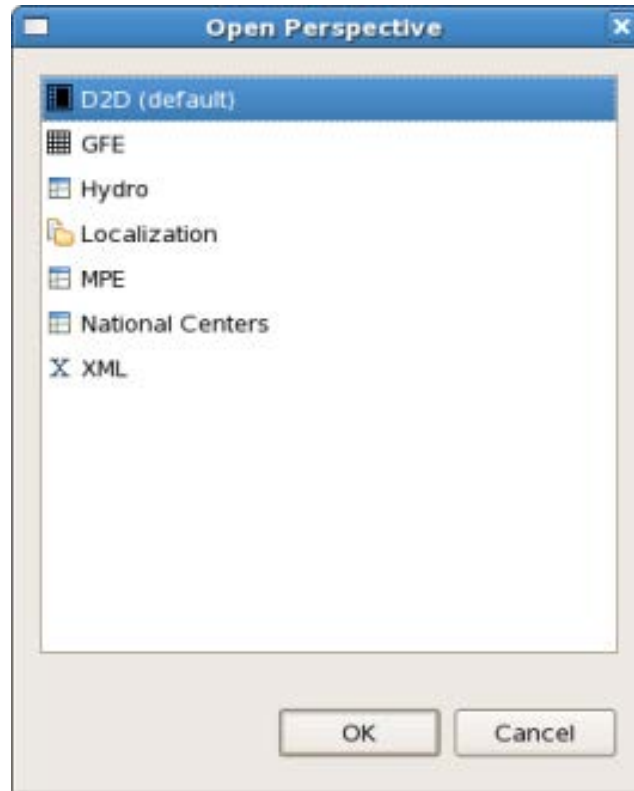

Once the *Open Perspective* dialog is displayed, select 'Localization' and click 'OK'. The Localization Perspective will open.

- g. After selecting your GFE role by clicking 'OK', the *Localization Perspective* opens.

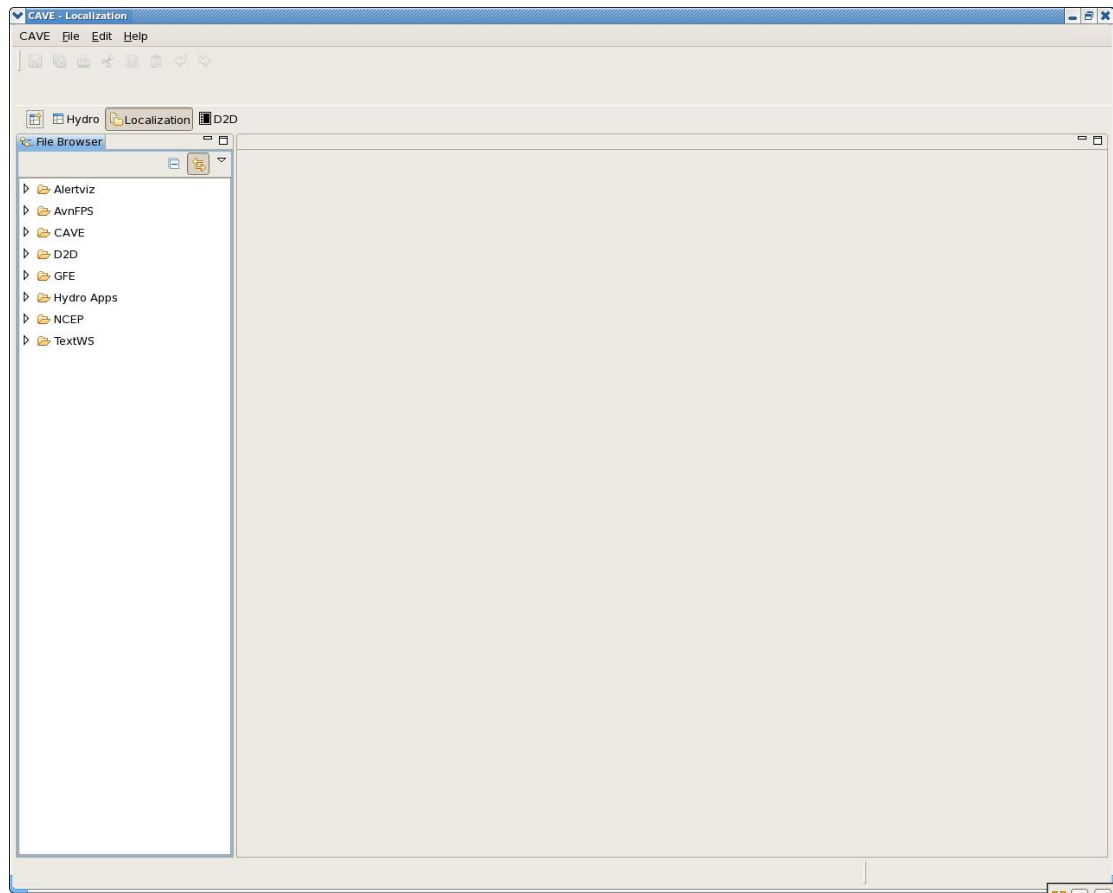

## 2. Edit configuration files in the Localization Perspective.

Once the *Localization Perspective* has been opened, specific configuration files are located using the *File Browser* located at the left of the window.

In this procedure, you will locate and open two files using the *Localization Perspective*: an XML file and a Python code file.

- a. If CAVE is not running on your workstation, follow the steps in Procedure 1 to start CAVE; once CAVE is running, open the *Localization Perspective*.
- b. The *File Browser* on the left is used to locate various configuration files. Expand *CAVE*→*Bundles*→*scales* → *scalesInfo.xml* to locate the file that controls the scale selector drop-down in the D2D perspective of CAVE.

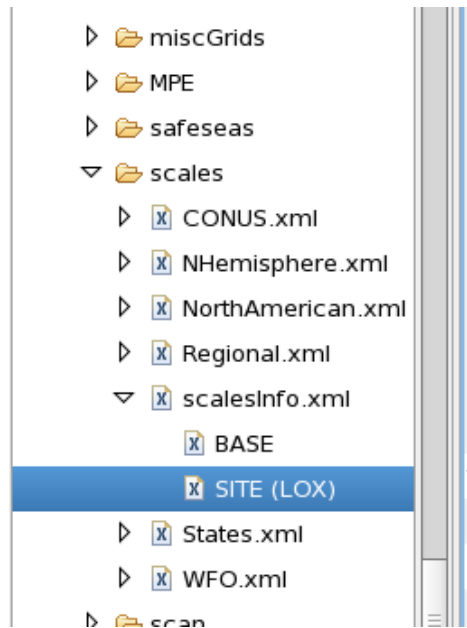

Note that there is a SITE level and BASE level version of this file.

- c. Double click on 'SITE' to open the site-level version in the XML editor.

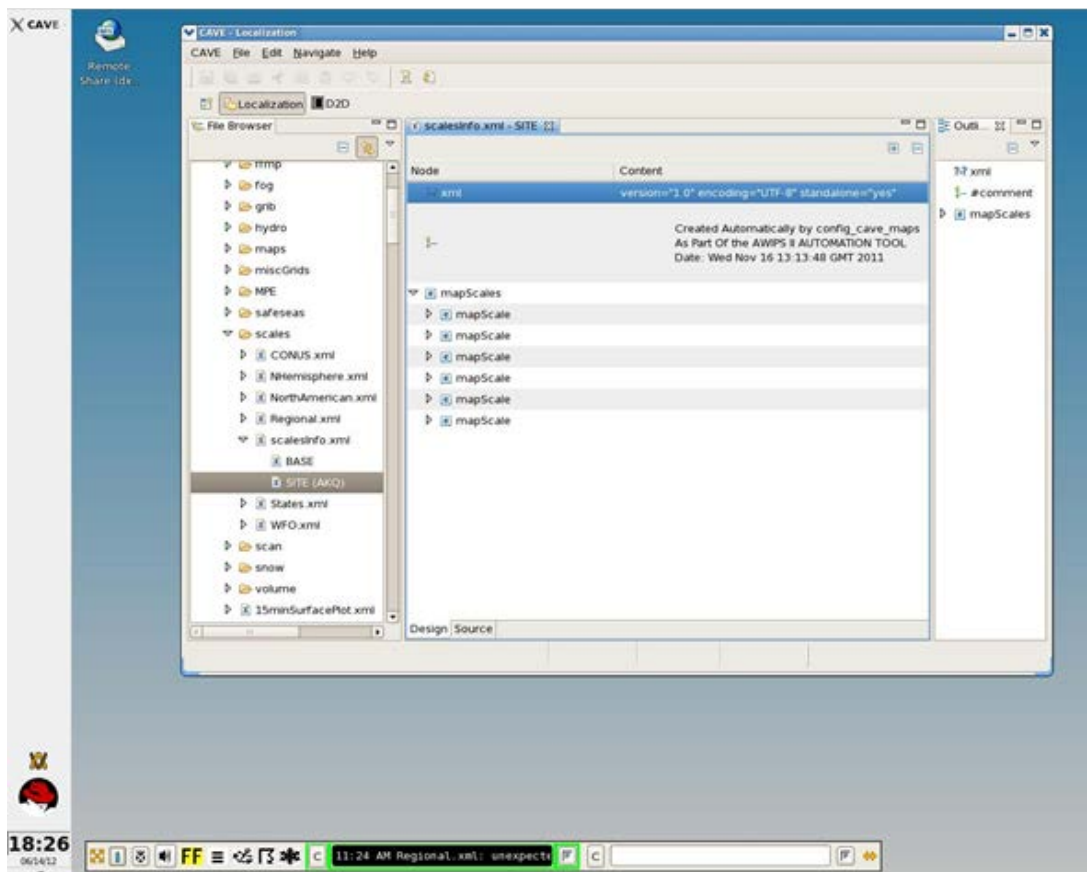

**Note:** The XML Editor has two display options; *Design* and *Source* (as noted at the bottom of the *scalesInfo.xml-SITE* window). By default, the file is opened in *Design* mode. Design mode provides a tree-like view of the XML file. In design mode, existing values may be modified without directly editing the XML.

d. To view the actual XML, click the ‘Source’ tab at the bottom of the editor.

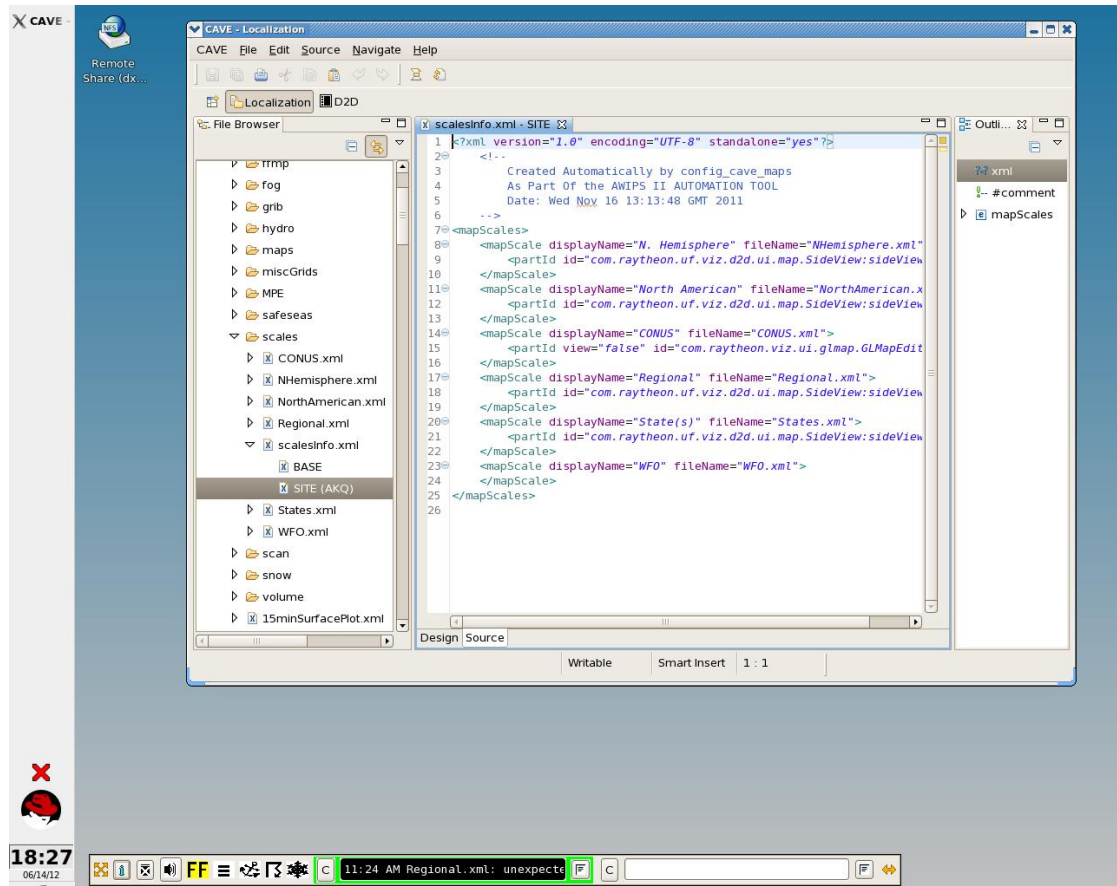

Close the editor by clicking the ‘X’ on the tab at the top of the editor.

e. Expand *D2D*→*Derived Parameters*→*python*→*DerivParamImporter.py* to locate the Derived Parameters Python Importer script.

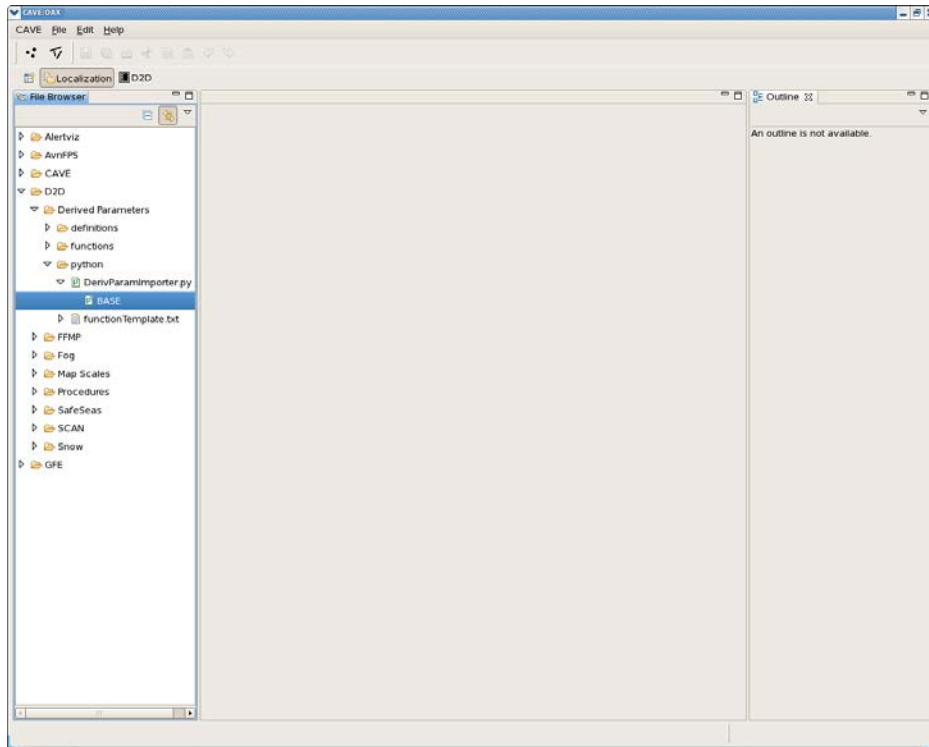

Note that there is only a single version of this file, the BASE version.

- f. Double click on 'BASE' to open the BASE version of the file in the editor.

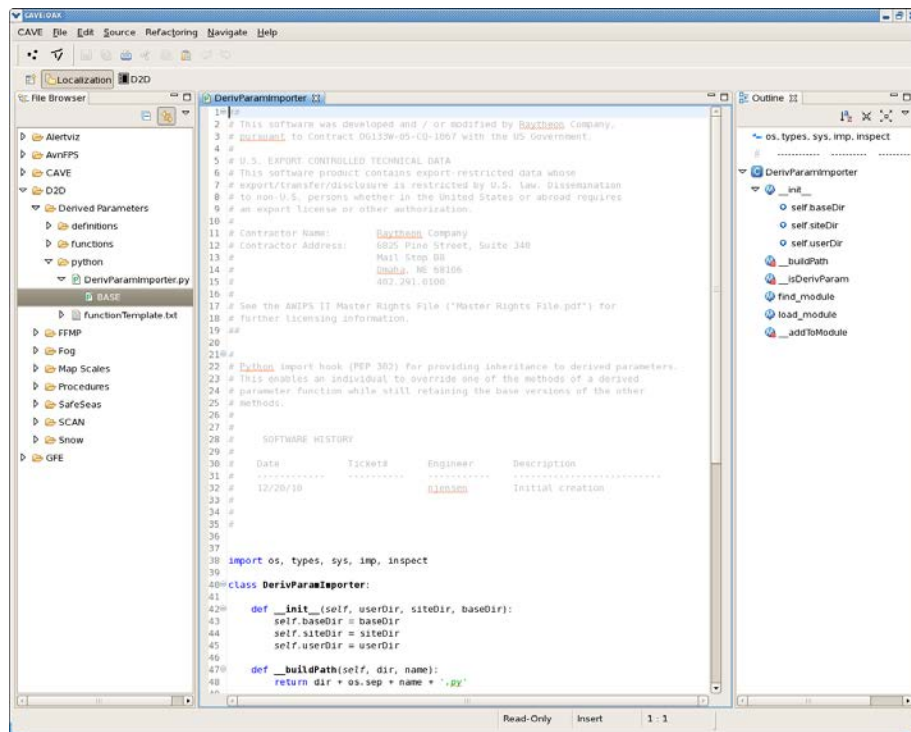

**Note:** For the Python file, a Python language enabled file editor is provided.





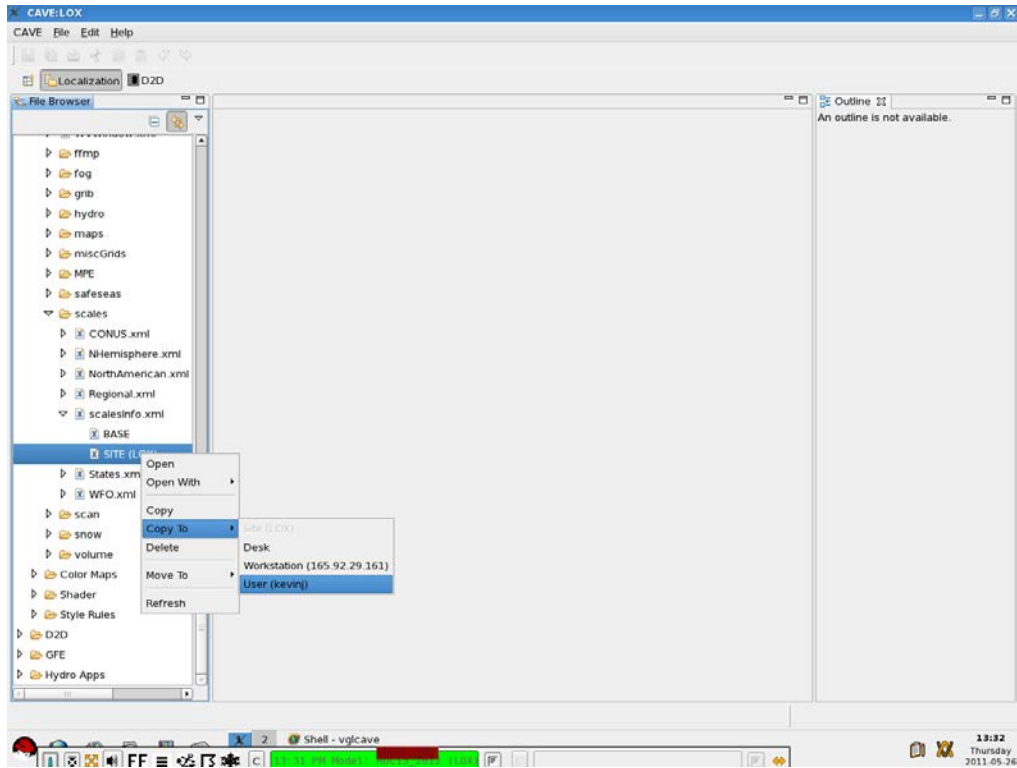

Replace xxxxx with your user name on the system.

- c. Double click 'USER (xxxxx)' to open scalesInfo.xml for editing.

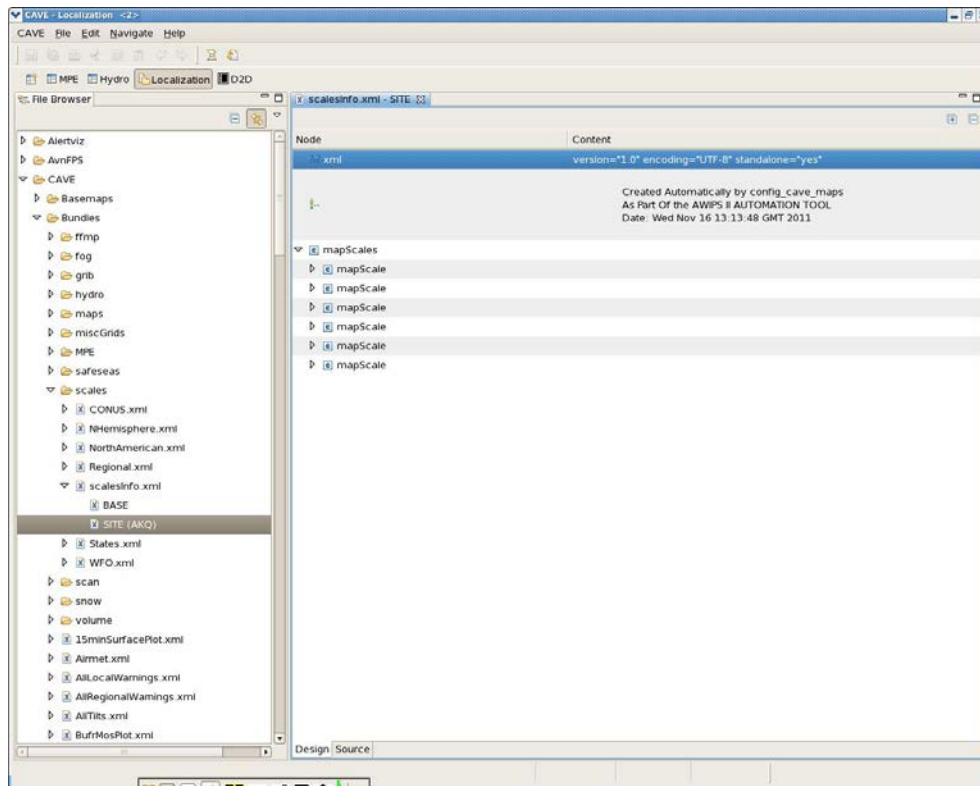

- d. Use the arrow next to the last mapScale in the editor to expand down the field. Notice that it is the entry for the WFO scale.

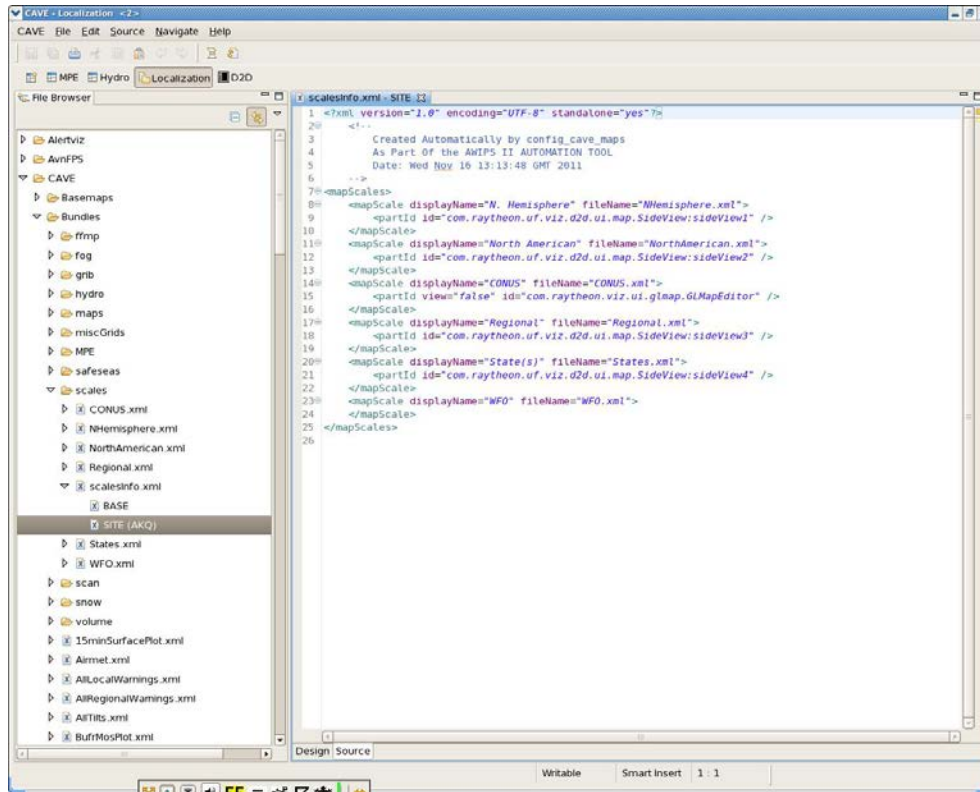

See what happens when this scale is deleted! Right click on the “mapScale” and select ‘Remove’.

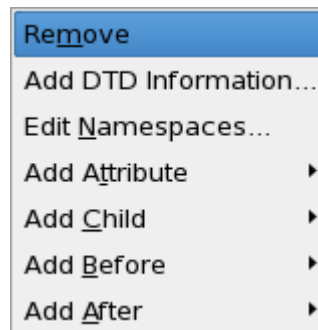

- e. Click on the ‘Source’ tab at the bottom of the middle window and view the XML syntax. Notice that there is no <mapScale> for WFO now. Click the ‘Save’ button in the upper left corner of CAVE (under the CAVE menu).

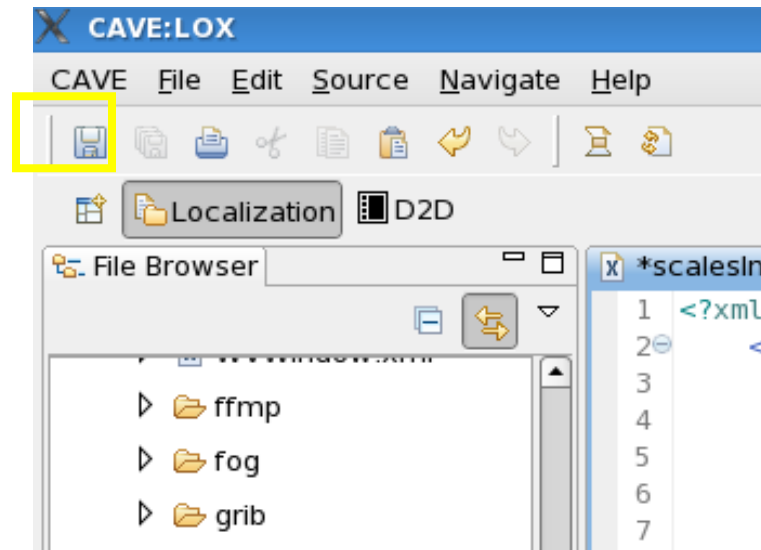
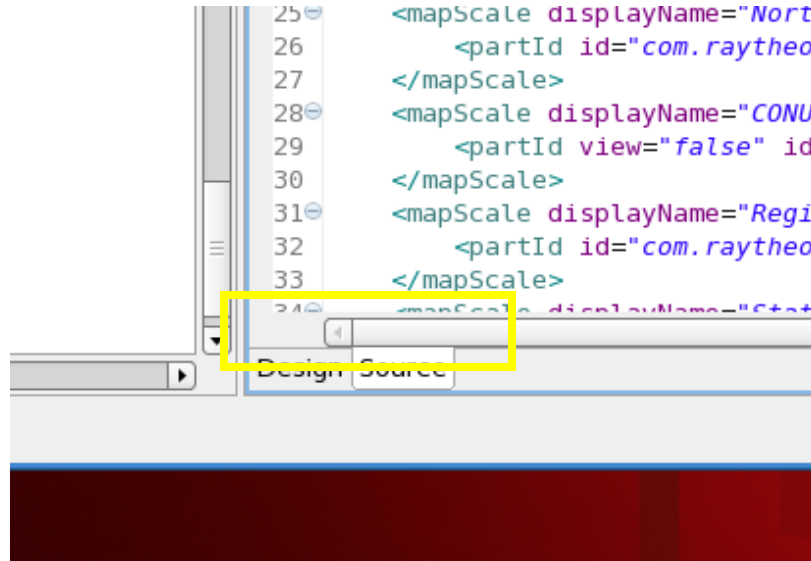

- f. Use the perspective-switching tabs at the top to go back to the D2D perspective. Use the menu dropdown selector, and try to switch to WFO scale. It should not be available!
- g. Switch back to the localization perspective by clicking on the tab. Click the 'Source' tab at the bottom of the window if scalesInfo is open in Design mode. Then hold down the right mouse button over the XML itself and navigate to 'Compare With → Local History'.

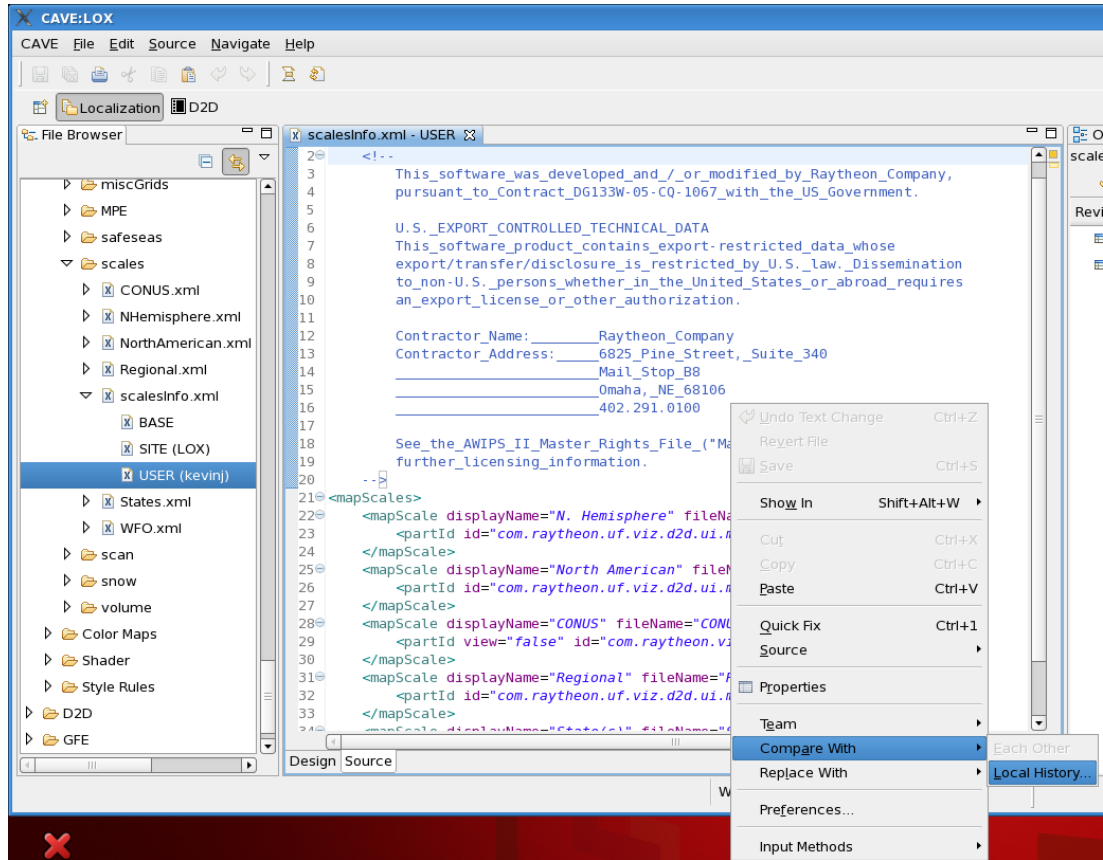

You will notice that a History tab appears on the right side of the perspective.

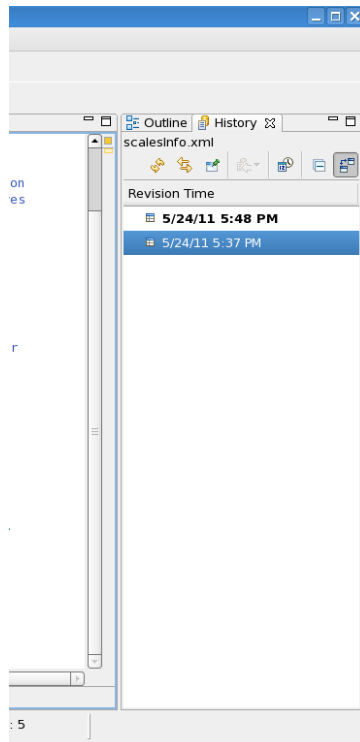

- h. Double click on the previous version and note that a comparison tab appears in the middle portion of the window. Note that the righthand side of the file shows the WFO entry present and highlighted.

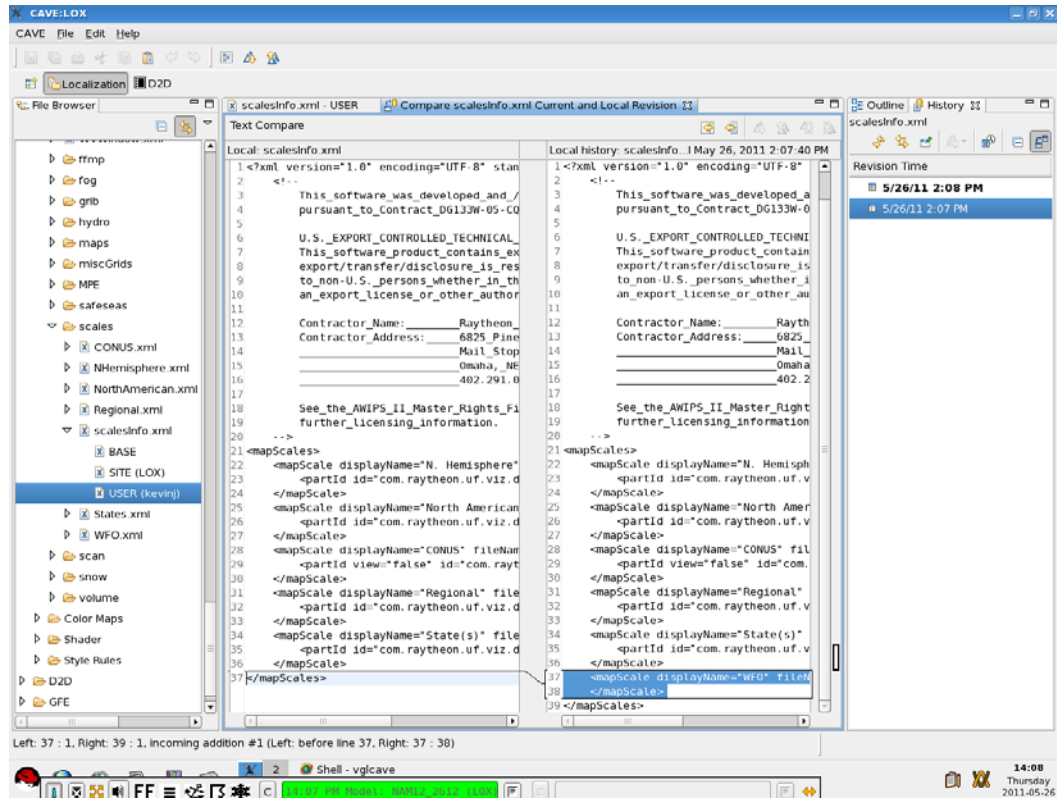

Close the ‘Compare scalesInfo.xml Current and Local Revision’ tab by using the “x” in the title bar

- i. Use the right mouse button to select the older version in the History browser, taking note to hold down the button until a menu appears. Select ‘Open’.

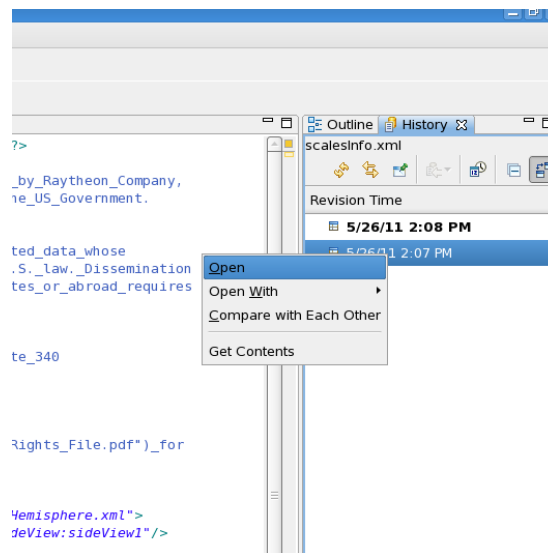

Note that a new tab has opened, which has the XML of the old version of the file. It does not have the string “USER” in the tab’s title and the WFO entry is present.

Close the tab by using the “x” in the tab title bar.

- j. Hold down the right mouse button in the XML of the scalesInfo.xml – USER tab and select ‘Replace With → Previous From Local History’.

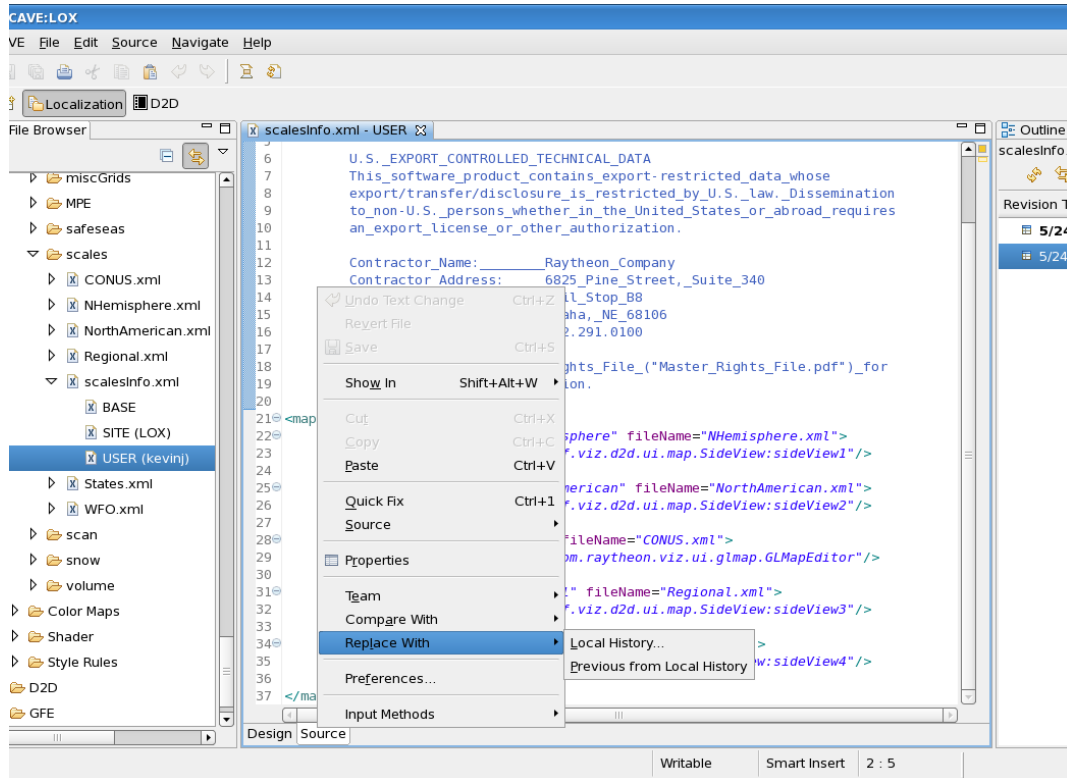

Note that the file now shows the WFO entry present.

- k. Use the perspective-switching tabs at the top to go back to the D2D perspective. Use the menu dropdown selector, and try to switch to WFO scale. It is now available again!
- l. Switch back to the localization perspective and right click on the USER (xxxxxx) version of scalesInfo.xml in the leftmost column (File Browser). Select ‘Delete’.  
You will receive a confirmation dialog, to which you should answer ‘OK’.
4. Look at a file that is not in XML format.

There are other types of files accessible via the Localization Perspective, and this procedure will show a few of them.

- a. If CAVE is not running on your workstation, follow the steps in Procedure 1 to start CAVE; once CAVE is running, open the *Localization Perspective*. Once the *Localization Perspective* is open, do the following to find *8 bit Refl.cmap*

- Expand CAVE in the File Browser by clicking the ▶
- Expand Color Maps in the File Browser by clicking the ▶
- Expand Radar folder by clicking the ▶
- Expand 8 bit Refl.cmap by clicking the ▶

**Note:** cmap files are color map files.

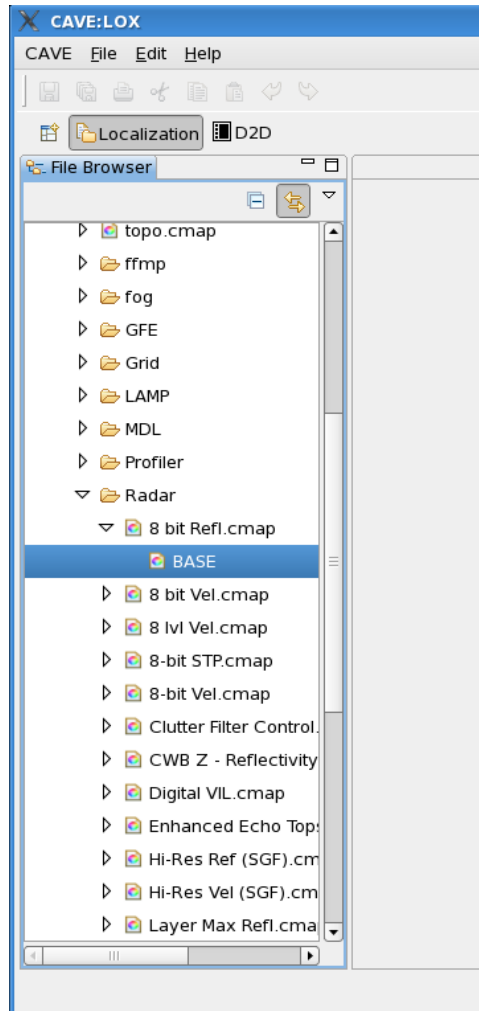

- b. Right click on 'BASE' and select 'Copy to→User(XXXXX)' from the popup menu. This will make a copy of the file into the selected site localization.



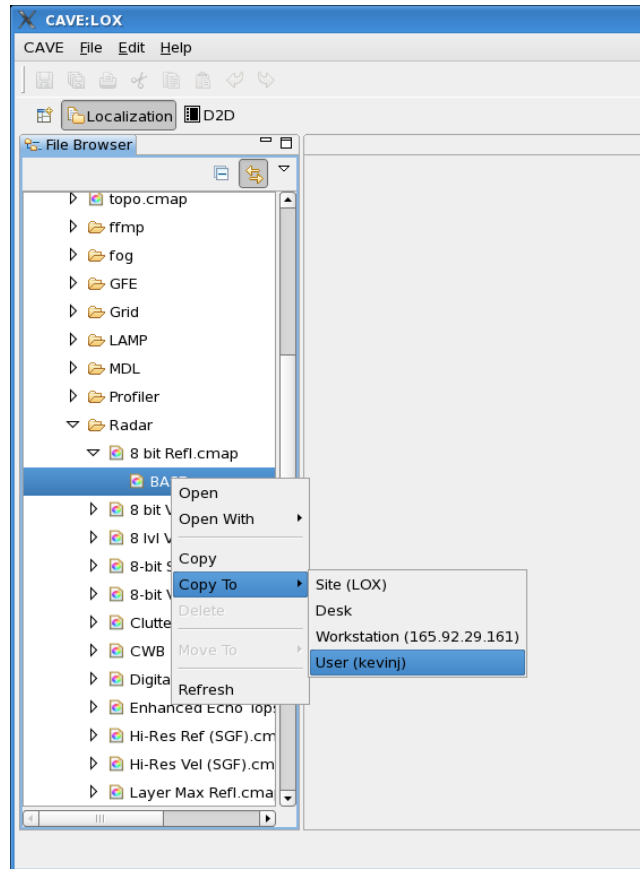

Replace xxxxx with your user name.

- c. Double click 'User (xxxxx)' to open the color map for editing.

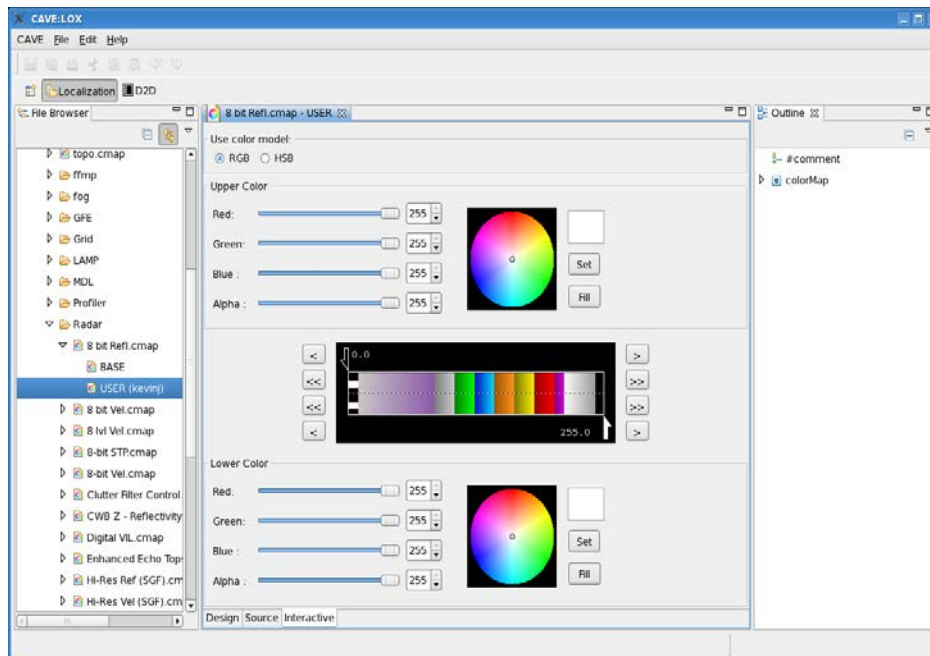

Note that the color wheel launches within the Localization Perspective to allow for easy editing of the color map.

- d. Close the color wheel editor by clicking the ‘x’ in the tab titled “8 bit Refl.cmap – USER”.
- e. Open a terminal window on your workstation.
- f. Log into DX3 using your student login.

Enter: **ssh dx3**

- g. Change directory to the EDEX Localization Store.

Enter: **cd /awips2/edex/data/utility/cave\_static/user/xxxxxx/colormaps/Radar**

- h. Perform a file listing to show the file has been copied to the EDEX Localization Store.

Enter: **ls -l**

- i. Log off DX3.

Enter: **exit**

- j. Expected results: Your terminal session should be similar to that shown below.

```
8 bit Refl.cmap 8 bit Refl.cmap.md5
```

- k. Use the already-open CAVE Localization Perspective to remove the user-level color map by holding down the right mouse button while selecting the USER (xxxxxx) file in the File Browser and selecting ‘Delete’.

## 5. Edit a location plot information file to add a new location.

Location plot information (.lpi) can also be edited via the localization perspective to add or remove stations.

- a. If CAVE is not running on your workstation, follow the steps in Procedure 1 to start CAVE; once CAVE is running, open the *Localization Perspective*. Once the *Localization Perspective* is open, do the following to find *8 bit Refl.cmap*
  - Expand CAVE in the File Browser by clicking the ►
  - Expand Basemaps in the File Browser by clicking the ►
  - Expand ldad15.spi folder by clicking the ►
- b. Right click on the SITE (XXX) file and select Copy To → User (xxxxxx).
- c. Double click on the file and note that it opens in plain text format in the middle pane. Add a line at the top of the file that looks like the other entries. **Note:** Use spaces and not TABs in this file. Use the following to decide what to add:



## **Appendix T**

### **Service Backup**

## Appendix T. Service Backup

### Table of Contents

	<i>Page</i>
T.1 Scope .....	1
T.2 AWIPS I Service Backup .....	1
T.3 AWIPS II Service Backup.....	2
T.3.1 Service Backup Design and Configuration.....	3
T.3.1.1 Service Backup GUI.....	5
T.3.1.1.1 Emergency GFE .....	6
T.3.1.1.2 Import Configuration.....	6
T.3.1.1.3 Export Digital Data to Failed Site .....	9
T.3.1.1.4 Export Configuration.....	10
T.3.1.1.5 Export Digital Data.....	11
T.3.1.1.6 Export Failed Site’s Digital Data to Central Server .....	13
T.3.2 Initiating Service Backup.....	14
T.4 Intrasite Coordination in AWIPS II.....	17
T.5 EDEX Service Backup Service .....	18
T.6 IFPS Service Backup in AWIPS II.....	18
T.7 Modified Functionality.....	20

### List of Exhibits

Exhibit T.2-1. AWIPS I Service Backup GUI.....	1
Exhibit T.3-1. AWIPS II Service Backup Interface .....	2
Exhibit T.3.1-1. AWIPS II Service Backup Directory Structure.....	3
Exhibit T.3.1.1-1. Service Backup GUI.....	6
Exhibit T.3.1.1.2-1. Import Configuration GUI.....	7
Exhibit T.3.1.1.2-2. Import Configuration Execution .....	7
Exhibit T.3.1.1.2-3. Digital Data Import Option .....	8
Exhibit T.3.1.1.2-4. Import Digital Data Execution .....	8
Exhibit T.3.1.1.3-1. Export Grids to Failed Site.....	9
Exhibit T.3.1.1.3-2. Export Data to Failed Site - Sender.....	10
Exhibit T.3.1.1.3-3. Export Data to Failed Site - Receiver.....	10
Exhibit T.3.1.1.4-1. Configuration Exported Table Item .....	11
Exhibit T.3.1.1.5-1. Digital Data Exported Table Item .....	12
Exhibit T.3.1.1.5-2. Export Digital Data Execution .....	13
Exhibit T.3.1.1.6-1. Grids Exported to Central Server .....	13

Exhibit T.3.1.1.6-2. Export Digital Data to Central Server Execution..... 14  
Exhibit T.6-1. AWIPS II App Launcher..... 19  
Exhibit T.6-2. AWIPS II Service Backup Application..... 19

**List of Tables**

Table T.4-1. ISC Configuration Files ..... 18

The AWIPS service backup capability is designed to allow one WFO to assume the functions of another site that has failed in order to retain high availability of services and products. Therefore, an effective method of transferring configuration and forecast data was incorporated into the AWIPS system. AWIPS II seeks to incorporate this capability into the new architecture.

### ***T.1 Scope***

This document describes the service backup capabilities present in the AWIPS II system. The major functions present in the AWIPS I service backup component have been incorporated into the AWIPS II architecture. There are several important differences between the existing AWIPS I service backup component and the service backup component present in AWIPS II. These differences are described in this appendix, and the new procedure for initiating and using service backup in AWIPS II is explained in detail.

### ***T.2 AWIPS I Service Backup***

The AWIPS I service backup (see Exhibit T.2-1) component exposes 10 operations to the user via a graphical user interface for executing service backup.

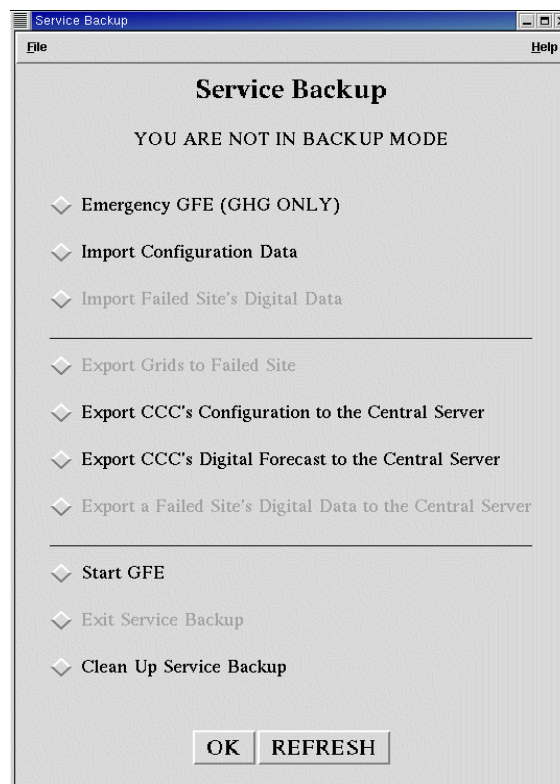

**Exhibit T.2-1. AWIPS I Service Backup GUI**

These operations are:

1. Emergency GFE
2. Import Configuration Data
3. Import Failed Site's Digital Data
4. Export Grids to Failed Site
5. Export CCC's Configuration to the Central Server
6. Export CCC's Digital Forecast to the Central Server
7. Export a Failed Site's Digital Data to the Central Server
8. Start GFE
9. Exit Service Backup
10. Clean Up Service Backup

### ***T.3 AWIPS II Service Backup***

AWIPS I uses a stand-alone graphical user interface for executing service backup operations. AWIPS II has replaced the stand-alone GUI with an interface that is a component of CAVE for controlling service backup operations. (See Exhibit T.3-1.)

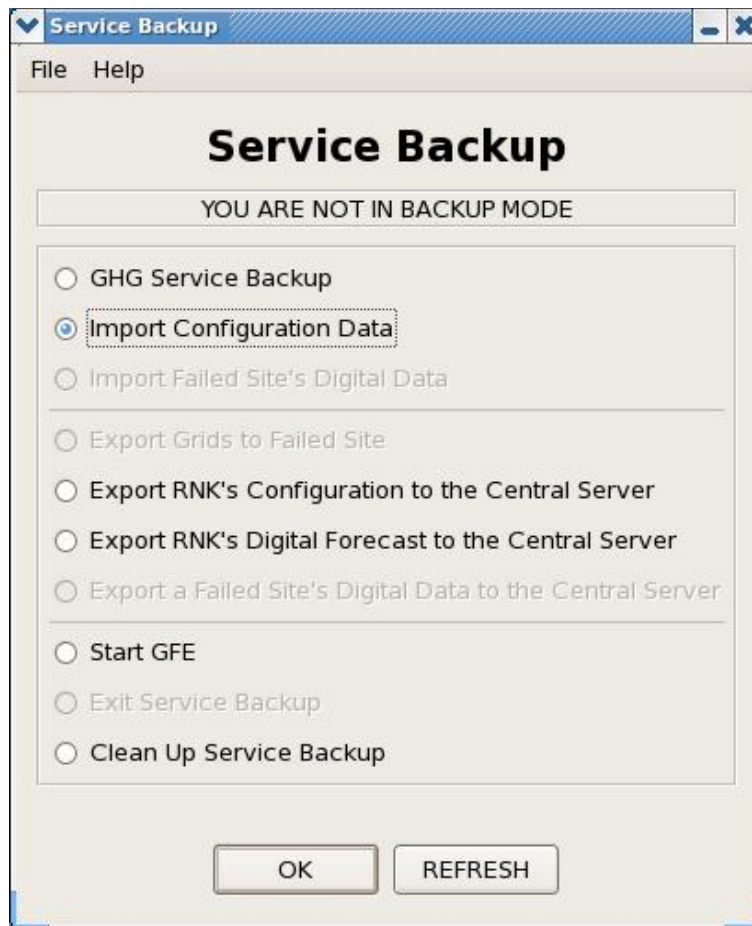

**Exhibit T.3-1. AWIPS II Service Backup Interface**



A fundamental difference between the AWIPS I and AWIPS II architectures is that AWIPS II can run as two or more WFOs simultaneously. The primary site is your site. Any additional sites that are currently running on your EDEX server are listed under the active sites list.

### T.3.1 Service Backup Design and Configuration

AWIPS II reuses much of the functionality of the scripts from AWIPS I, but these have been significantly cleaned up to only perform the needed functions. In AWIPS I the scripts contained a lot of code that is not used.

These scripts are included in the AWIPS II installer and are placed in the appropriate directories upon successful installation of AWIPS EDEX.

The service backup scripts are installed to {INSTALL\_DIR}/GFESuite. The directory structure of the GFESuite directory is shown in Exhibit T.3.1-1.

```

GFESuite/
|-- ServiceBackup
|   |-- configuration
|   |   |-- svcbu.env
|   |   |-- svcbu.properties
|   |-- data
|   |-- locks
|   |-- logs
|   |-- scripts
|   |   |-- cleanup_svcbk
|   |   |-- createGFESstartScript
|   |   |-- echo_msg
|   |   |-- export_bksite_grids
|   |   |-- export_configuration
|   |   |-- export_grids
|   |   |-- export_grids_to_failed_site
|   |   |-- killProcess
|   |   |-- log_msg
|   |   |-- log_msg_python
|   |   |-- proc_receive_config
|   |   |-- proc_receive_grids
|   |   |-- process_configuration
|   |   |-- process_grids
|   |   |-- receive_configuration
|   |   |-- receive_configuration.py
|   |   |-- receive_grids
|   |   |-- receive_grids.py
|   |   |-- receive_grids_from_backup_site
|   |   |-- request_configuration
|   |   |-- request_grids
|   |   |-- siteID.txt
|   |   |-- start_svc_backup
|   |-- svcbu
|-- bin
|   |-- gfe_msg_send
|   |-- ifpBreakAllLocks
|   |-- ifpInit
|   |-- ifpnetCDF
|   |-- iscDataRec
|   |-- iscMosaic
|   |-- purgeAllGrids
|-- exportgrids
|   |-- tmp
|-- exportgrids2
|-- logs
|-- products
|   |-- ISC

```

**Exhibit T.3.1-1. AWIPS II Service Backup Directory Structure**

The main environment file (svcbu.env) is installed to ServiceBackup/configuration. The new configuration file svcbu.env, sources in the settings from the svcbu.properties file found in the same directory and sets the python environment. Note that the overall number of configurations has been significantly reduced from is found in AWIPS I. The system attempts to set up the AWIPS\_HOME variable automatically if one is not set. Typically, this variable would be set to /awips2.

Two example local environment files have been included and reside in the ServiceBackup/configuration folder. These files contain the local environment settings for a particular site. Several modifications have been made to these files so as to conform to the AWIPS II directory hierarchy. These are:

- SVCBU\_HOST variable needs to be changed to the name of the main EDEX server.
- CDSPOINT variable needs to be changed to the port of the main EDEX server, i.e., 9581.
- PYTHONPATH should not be set as it is already configured by EDEX.
- PRIMARY\_SITES should only be used by multi-domain sites. Otherwise, the setting must remain blank. As of 13.5.1, the software automatically uses the AW\_SITE\_IDENTIFIER setting. The setting is a comma-separated list of sites for the export grids cron to run for instead of the site set as AW\_SITE\_IDENTIFIER.
- NATIONAL\_CENTER setting has been deprecated as of 13.5.1 and should no longer be part of configuration.

The file svcbu\_export\_elements.ccc lists the weather elements that are to be packaged when transmitting digital data back to the central server. If you choose to use it, place it in the ServiceBackup/data folder. Additional files may be placed in this directory for different sites.

The scripts used for executing the service backup operations are included in the folder ServiceBackup/scripts. They are a subset of the scripts used in AWIPS I for service backup and contain several modifications for use with AWIPS II. The changes include:

- **Removal of ProgressBar.py and showProgress.py.** These have been replaced by equivalent Java dialogs.
- **Removal of the tcl scripts.** Tcl is not used in AWIPS II service backup for GUIs. The Java interface is used instead.
- **Removal of cron script.** The cron script that executes the export digital data operation has been removed. In AWIPS II, this task is executed from a quartz timer defined in the gfe-request.xml file in the EDEX GFE plug-in. A quartz timer has also been added to the same file to regularly remove accumulated log file directories. The /awips2/edex/conf/spring/cron.properties file defines time settings for the above quartz jobs.

- **Modifications to export and import configuration scripts.** Several modifications were made to the export and import configuration scripts. AWIPS II now bundles the information in {EDEX\_HOME}/data/utility/common\_static/site/{site} {EDEX\_HOME}/data/utility/edex\_static/site/{site}, and {EDEX\_HOME}/data/utility/cave\_static/site/{site} into the tarball to be exported. The import configuration scripts also expect these directories to be present. Upon receipt, the configuration tarball is unpacked and the site configuration is placed into the appropriate localization directories

The scripts are executed from a class called ServiceBackupJobManager.

Upon startup, EDEX adds the bin directories contained in the ServiceBackup directory structure to the PATH variable (see start.sh located in edex/bin directory). The directory structure containing the executables is different (simplified) from those found in AWIPS I. It is contained in the GFESuite/ServiceBackup directory. Since AWIPS II supports the idea of defining a dynamic install location, these files are not placed in the root of the system.

### **T.3.1.1 Service Backup GUI**

The Service Backup interface handles the same operations as the A1 service backup GUI operations critical to service backup. These are:

1. Emergency GFE
2. Import Configuration Data
3. Import Failed Site's Digital Data
4. Export Grids to Failed Site
5. Export CCC's Configuration to the Central Server
6. Export CCC's Digital Forecast to the Central Server
7. Export a Failed Site's Digital Data to the Central Server
8. Start GFE
9. Exit Service Backup
10. Clean Up Service Backup

The Export configuration and Export digital data operations are for use by your site. The remaining options operate on data used for backing up the failed site. Upon completion of the selected operation, a pop-up message will appear notifying the user of the success or failure of the operation. The following sections describe the available operations.

The service backup GUI is shown in Exhibit T.3.1.1-1.

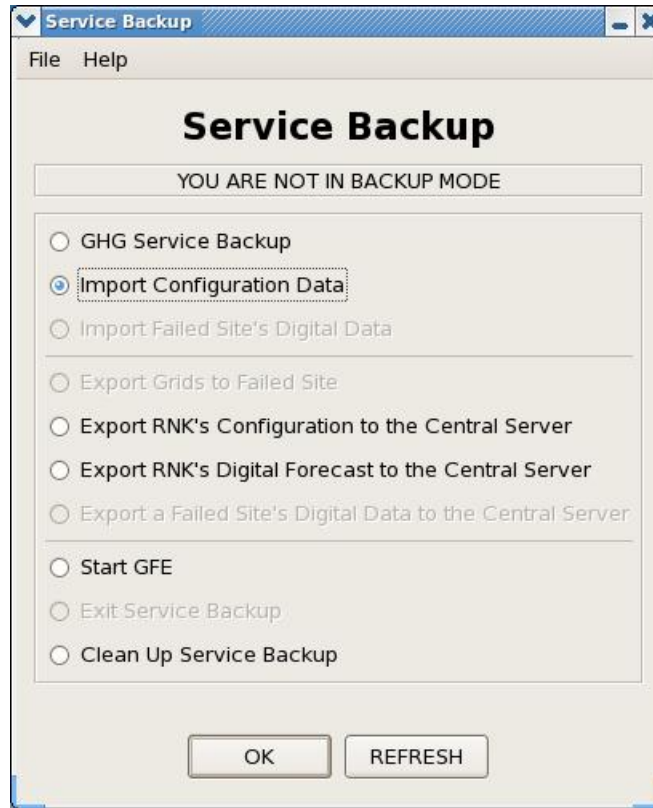

**Exhibit T.3.1.1-1. Service Backup GUI**

#### ***T.3.1.1.1 Emergency GFE***

Emergency GFE serves the purpose of a ‘quick’ backup. When the user chooses this option, a failed site’s configuration will be downloaded from the central server and GFE will open. No grids are downloaded using this option.

#### ***T.3.1.1.2 Import Configuration***

The import configuration operation imports the configuration information for a site so that service backup can be initiated. This operation is executed by clicking the Import Configuration Data radio button followed by the OK button at the bottom of the GUI as shown in Exhibit T.3.1.1-1. The user will be presented with a prompt to enter the failed site id (see Exhibit T.3.1.1.2-1).



**Exhibit T.3.1.1.2-1. Import Configuration GUI**

This operation communicates with the Message Handling System (MHS) to retrieve the configuration for the desired site. Once the configuration data arrives, the MHS kicks off a script called `receive_configuration`. This script unpacks the retrieved data and places the configuration information in the appropriate localization directories for the requested site. Exhibit T.3.1.1.2-2 shows the flow of execution for importing a configuration.

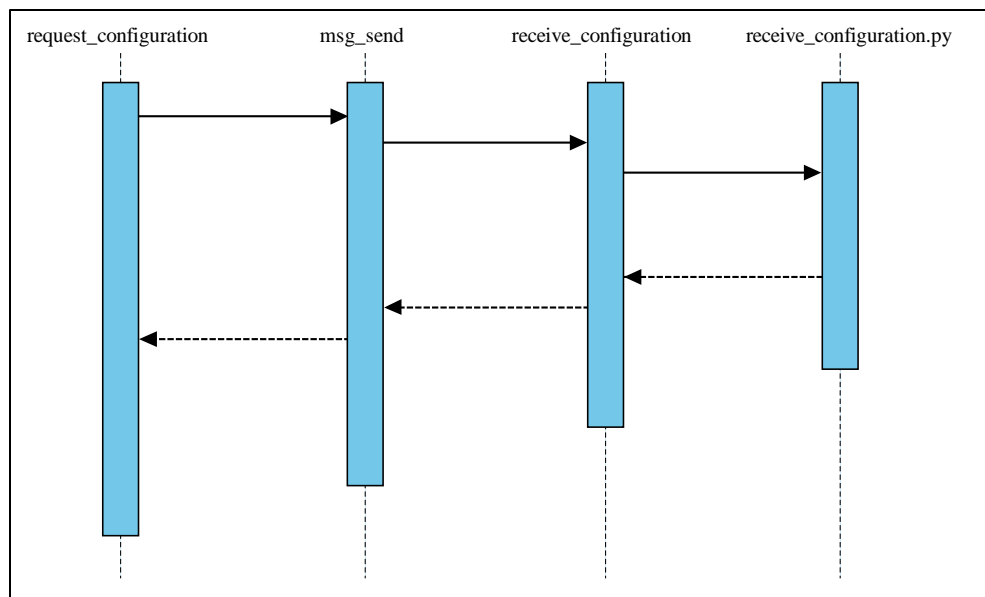

**Exhibit T.3.1.1.2-2. Import Configuration Execution**

The digital data operation imports grid data for a site so service backup can be initiated. This operation is executed either by selecting it at the time the import of configuration is initiated, or by clicking the Import Digital Forecast radio button, followed by the OK button at the bottom of the main Service Backup GUI (see Exhibit T.3.1.1.2-3). **Note:** The Import Digital Forecast button in Exhibit T.3.1.1.2-3 will be in disable mode (grayed out) while you are in the process of importing a site's configuration or digital data.



**Exhibit T.3.1.1.2-3. Digital Data Import Option**

This operation sends a request message to the MHS via the msg\_send application. The MHS requests the data and places it into MHS X400 directory. The MHS then kicks off a script that integrates the data into the data stores via iscMosaic. After this operation is completed, service backup is ready to use for backing up a failed site. Exhibit T.3.1.1.2-4 shows the flow of execution for importing digital data.

**Note:** The Start GFE button in the above Exhibit will only be enabled after you have successfully imported the failed site’s configuration. Also, it will be disabled while you are importing a failed site’s configuration or digital data or when you are not in Service backup mode.

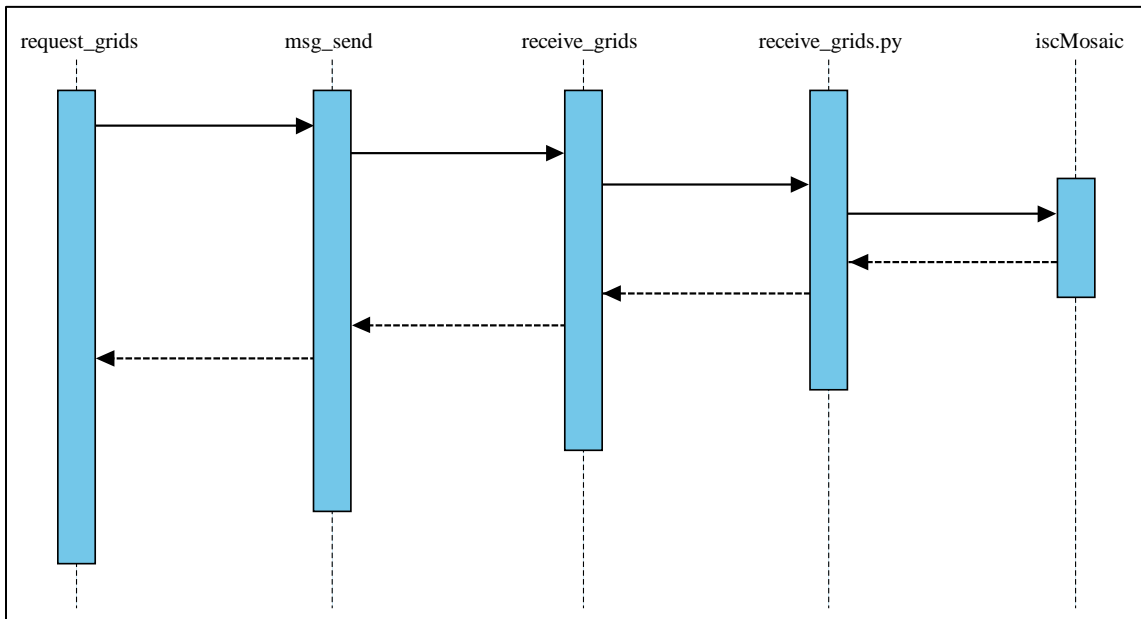

**Exhibit T.3.1.1.2-4. Import Digital Data Execution**

### T.3.1.1.3 Export Digital Data to Failed Site

The “export digital data to failed site” operation (when you are in the Service Backup mode) exports the digital data from your site back to the failed site. This operation is executed by clicking the Export Grids to Failed Site radio button followed by the OK button at the bottom of the GUI. (See Exhibit T.3.1.1.3-1.)

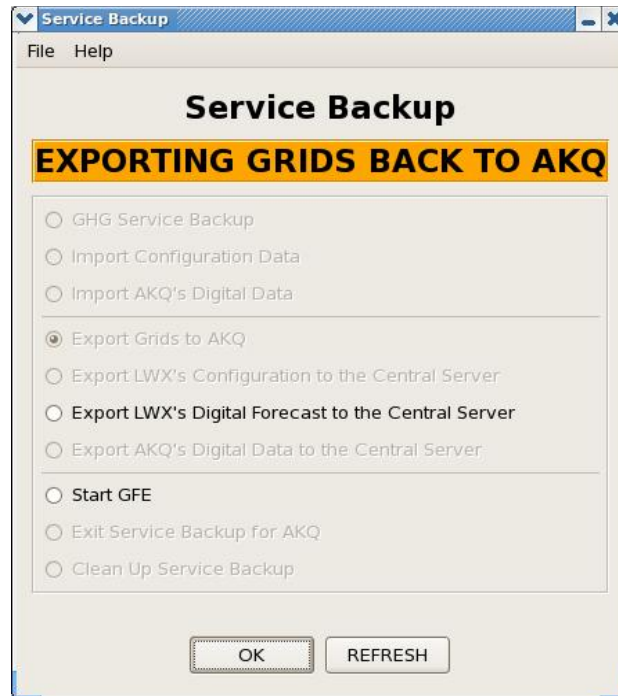

**Exhibit T.3.1.1.3-1. Export Grids to Failed Site**

Executing this operation kicks off a sequence of execution on both the sender side and the side receiving the data. The sending side packages the grids in netCDF format and sends a message to the MHS via `msg_send`, which sends the grids back to the failed site. The MHS at the receiving site kicks off a script to unpack and place the received grids in the RESTORE database using `iscMosaic`.

Exhibit T.3.1.1.3-2 shows the flow of execution on the sending side when the Export to Failed Site operation is initiated.

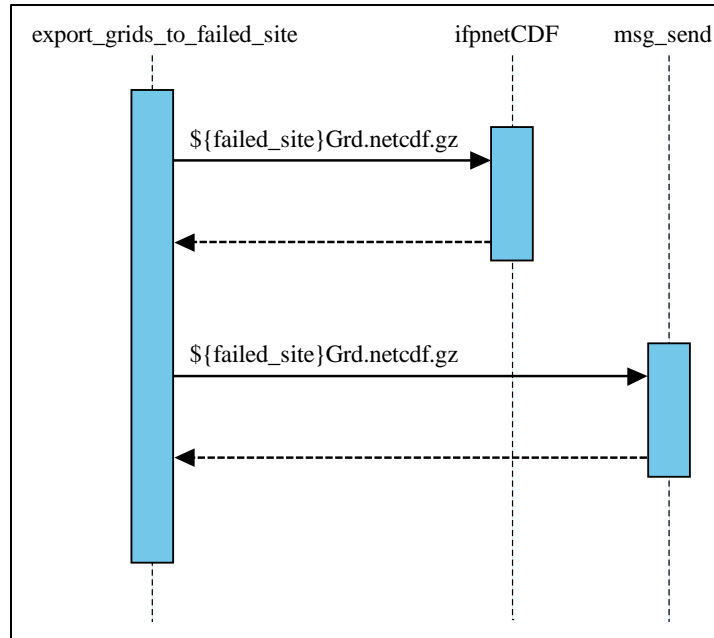

**Exhibit T.3.1.1.3-2. Export Data to Failed Site - Sender**

Exhibit T.3.1.1.3-3 shows the flow of execution on the receiving site when the export to failed site operation is initiated.

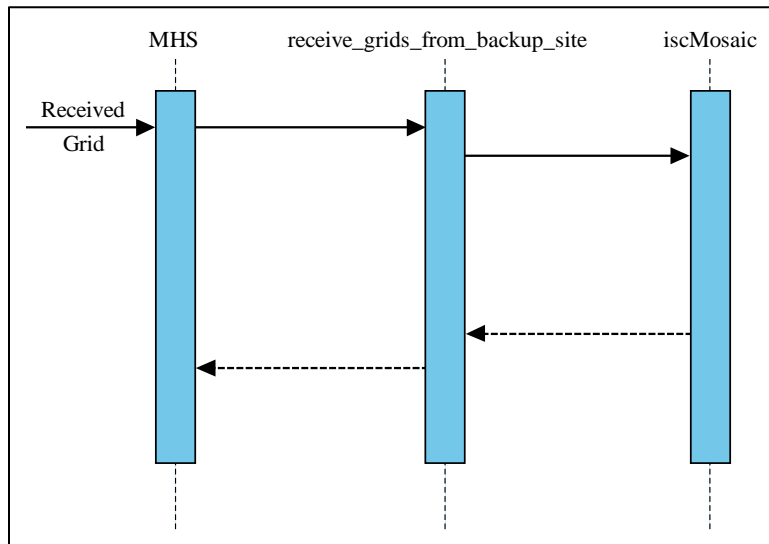
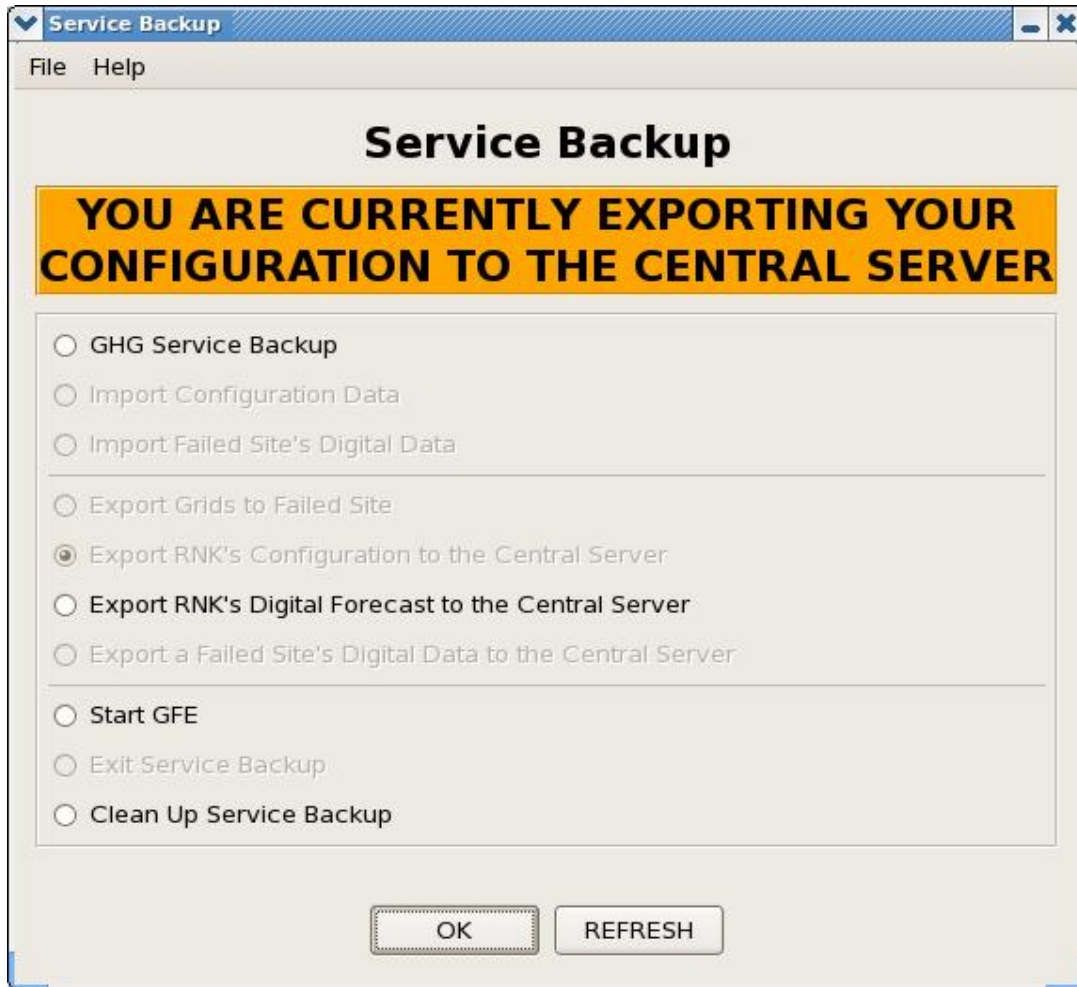

**Exhibit T.3.1.1.3-3. Export Data to Failed Site - Receiver**

**T.3.1.1.4 Export Configuration**

The export configuration operation packages your site’s configuration information and transmits it to the central server. This operation is executed by clicking the Export CCC’s Configuration to the Central Server radio button followed by the OK button at the bottom of the GUI. (See Exhibit T.3.1.1.4-1.)





**Exhibit T.3.1.1.4-1. Configuration Exported Table Item**

Exporting a configuration consists of:

1. Executing the export\_configuration script to package up the site configuration for your site from the common\_static, edex\_static, and cave\_static directories and
2. Transmitting them via msg\_send to the central server.

#### ***T.3.1.1.5 Export Digital Data***

The export digital data operation exports your site's digital data to the central server. This operation is executed by clicking the Export CCC's Digital Forecast to the Central Server radio button followed by the OK button at the bottom of the GUI. (See Exhibit T.3.1.1.5-1.)

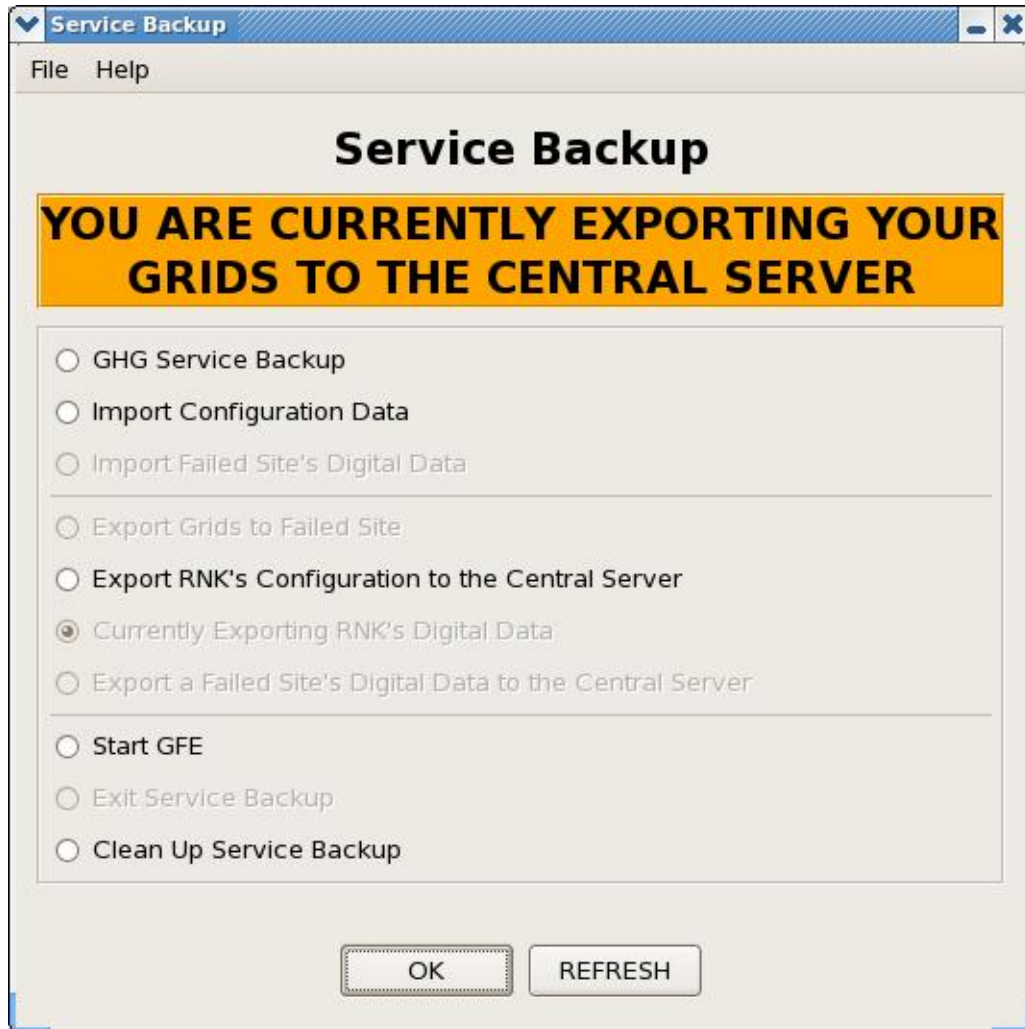

**Exhibit T.3.1.1.5-1. Digital Data Exported Table Item**

Exporting digital data consists of packaging up the site grids using ifpnetCDF and placing them in the export grids directory located at {AWIPS\_HOME}/GFESuite/exportgrids/primary for grids exported for the primary site(s), and {AWIPS\_HOME}/GFESuite/exportgrids/backup for grids exported for the failed site. The grids placed in the exportgrids subdirectories get uploaded to the central server via the rsync process.

Exhibit T.3.1.1.5-2 shows the flow of execution for exporting digital data.

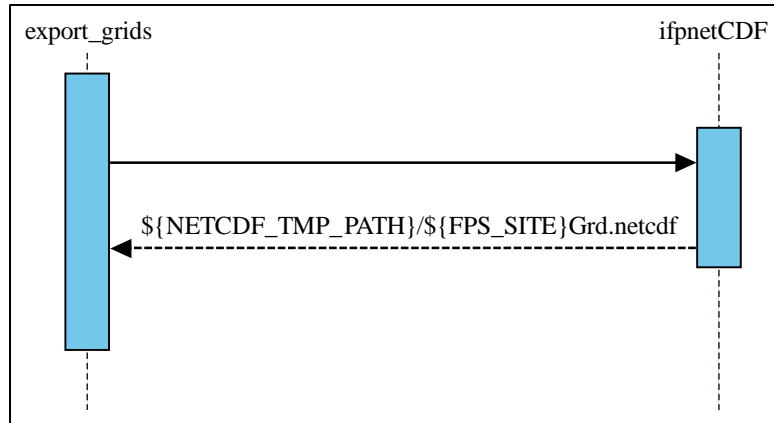

Exhibit T.3.1.1.5-2. Export Digital Data Execution

### T.3.1.1.6 Export Failed Site's Digital Data to Central Server

This operation exports the failed site's digital data from your site to the central server. The operation is executed by clicking the Export [a Failed Site's Data] to the Central Server radio button followed by the OK button. (See Exhibit T.3.1.1.6-1.)

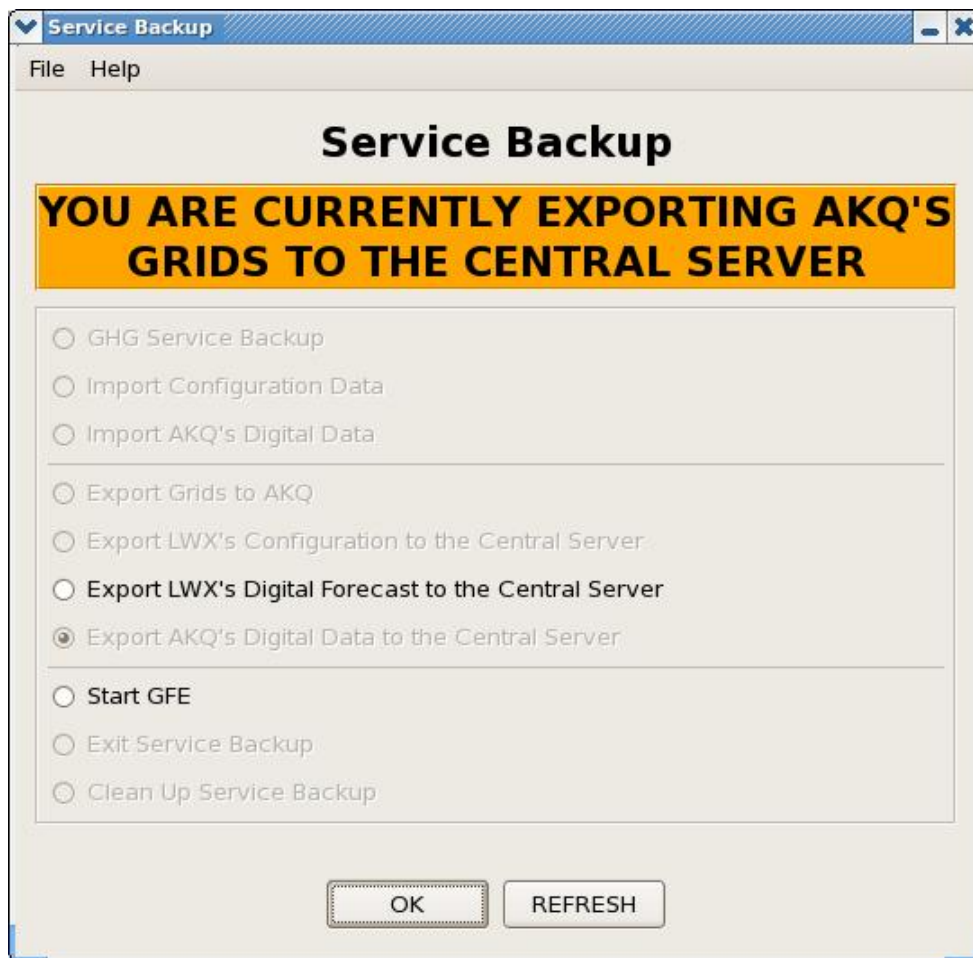

Exhibit T.3.1.1.6-1. Grids Exported to Central Server

This operation packages the digital data for the failed site and sends it to the central server via the MHS.

In Exhibit T.3.1.1.6-1, the Exit Service Backup button will be enabled only while you are in Service Backup Mode. It will allow you to clean up the Failed Site's Configuration, and it will close the Service Backup GUI when finished.

The Clean Up Service Backup button in Exhibit T.3.1.1.6-1 will allow you to clean up a Failed Site's Configuration if you are in Service Backup Mode. If you are not currently in the Service Backup Mode, you will be prompted for the Site ID that you wish to clean up. Also, this button will be disabled while you are importing a failed site's digital data.

Exhibit T.3.1.1.6-2 shows the flow of execution for exporting digital data to the central server.

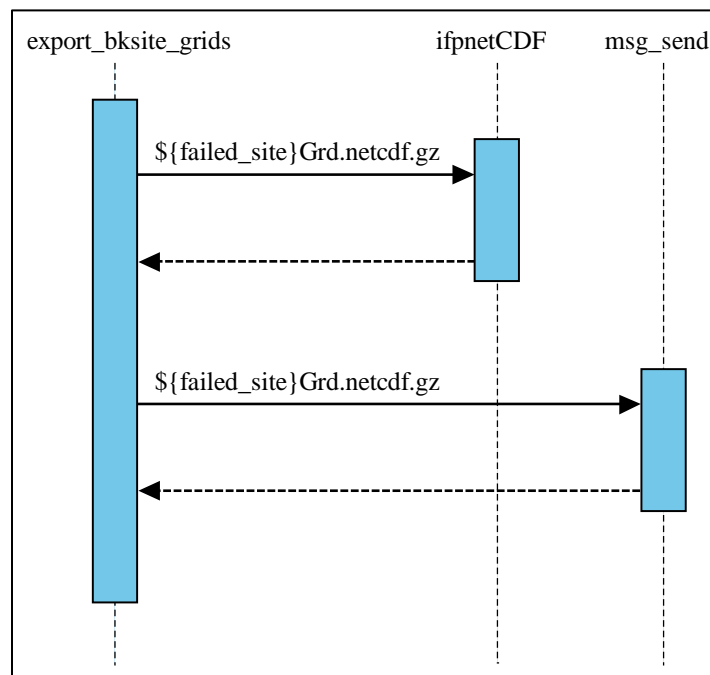
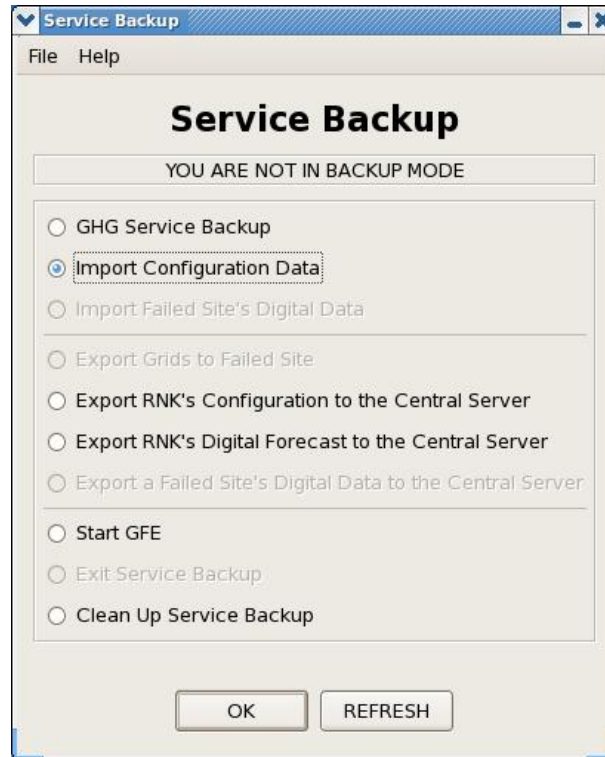

Exhibit T.3.1.1.6-2. Export Digital Data to Central Server Execution

### T.3.2 Initiating Service Backup

1. Service backup for a failed site is initiated through the command line, or by using appLauncher (described shortly). Start the Service backup interface either through appLauncher, or by entering at the command line

**TYPE:** `/awips2/cave/cave.sh -component ServiceBackup`



2. Import the configuration data for the failed site. If the configuration files are already present on your system, this step is not necessary. If the configuration data for that site is not present on your system, it needs to be retrieved. Click the Import Configuration Data radio button followed by the OK button at the bottom of the GUI. Prompts for the failed site id and additional operations to execute will display in succession. Enter the failed site id and click OK to proceed. If the configuration is successfully retrieved, a pop-up message will confirm it. At the time of requesting configuration, you will also have the option of importing Digital Forecast Data and starting GFE:





3. Assuming the configuration was imported successfully and the site was activated successfully, the digital data may now be imported.

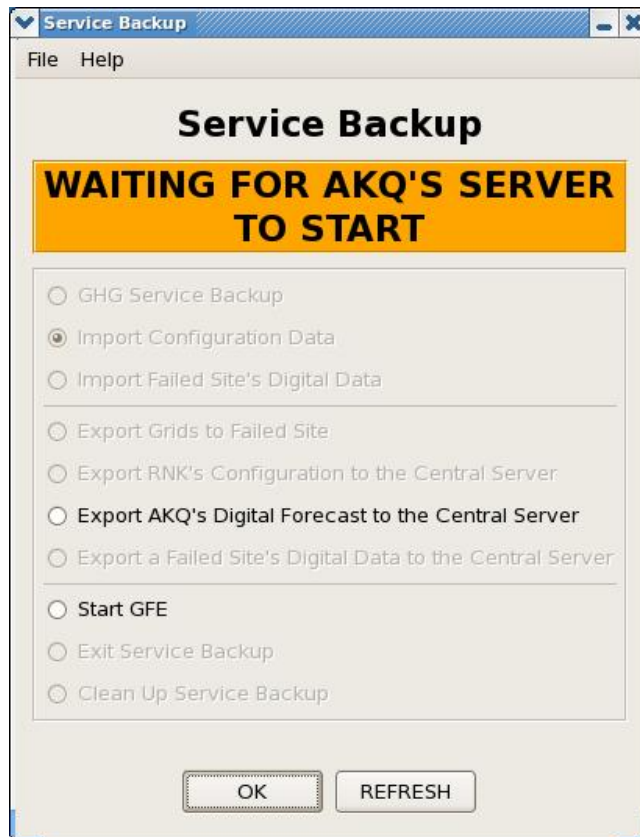

4. Service backup scripts will contact the MHS and retrieve the digital data for that site. If you had not selected to start GFE during the first step, you would be presented with the option to do.

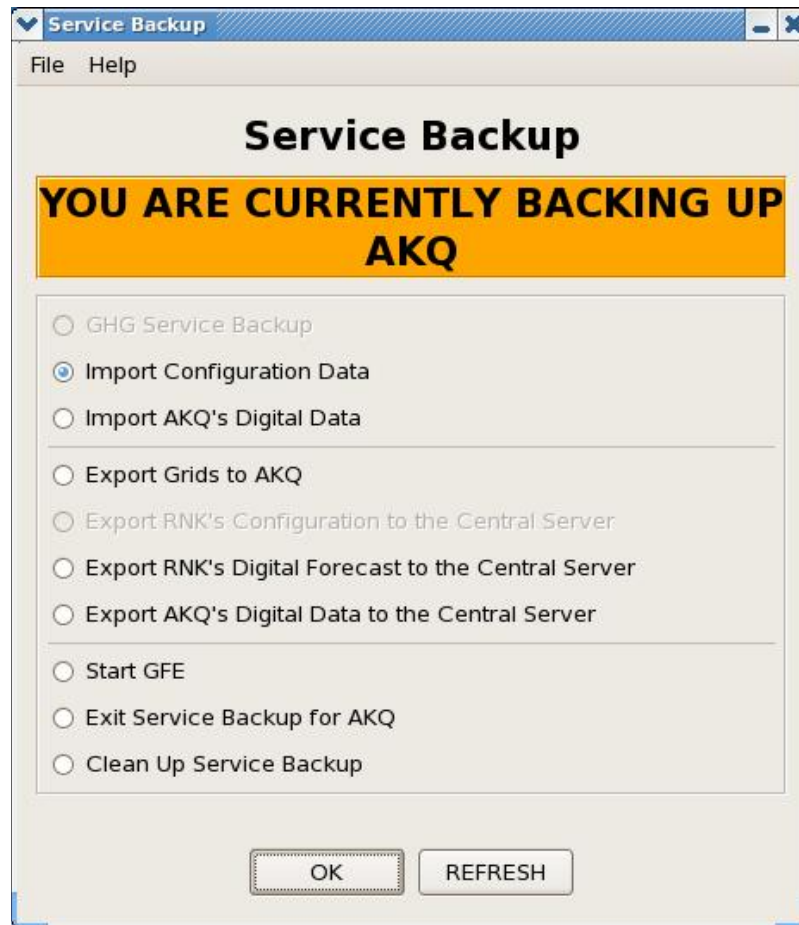

Service backup is now ready for use for the selected site. CAVE can now be started localized to the failed site.

#### ***T.4 Intrasite Coordination in AWIPS II***

ISC has been incorporated into the EDEX Request Processes that run on DX3 and DX4. The EDEX Request process performs ISC routing tasks based on configuration in two configuration files:

1. **localConfig.py**. Defines ISC transmission information.
2. **siteConfig.py**. Defines ISC server information.

Both of these files are converted from the existing AWIPS I files at software installation; In AWIPS II, these files are located in the AWIPS II Localization Store on DX3/4. The file locations are shown in Table T.4-1.

**Table T.4-1. ISC Configuration Files**

File	Location (Relative to /awips2/edex/data/utility)
localConfig.py	edex_static/site/XXX/config/gfe
siteConfig.py	edex_static/site/XXX/config/gfe

In Table T.4-1, XXX represents the site identifier, e.g., OAX.

**Note:** Do not add declarations to localConfig.py that override system variables. Now that GFE processing has been incorporated into EDEX, these declarations could negatively affect the behavior of multiple systems. For example, do not set TZ inside localConfig.py as it will have an adverse effect on the behavior of WarnGen.

It is important to recognize that ISC operation remains essentially unchanged. As grids are modified and/or published in the CAVE GFE perspective, they are forwarded to the ISC server. Depending on the configuration values in localConfig.py, this may be automatic or it may be by forecaster action.

### **T.5 EDEX Service Backup Service**

The server side applications (ifpServer, etc.) supporting Service Backup have been reengineered as EDEX Services. Operationally, there is little change in AWIPS II. The configuration location for Service Backup has changed. The primary configuration file, located in /awips2/GFESuite/ServiceBackup/configuration, is svcbu.properties.

The EDEX Service Backup Service is part of the EDEX request process. It is activated by a Quartz trigger that fires at 15 minutes after each hour. Service Backup events are logged in two places: 1) in the EDEX request log in /awips2/edex/logs; and 2) in the Service Backup log in /awips2/GFESuite/ServiceBackup/logs/<yyyymmdd>, where yyyymmdd is the date stamp for the logs.

The rsync process is still used to send exported grids to the Central Server. Those grids are rsync'ed from the /awips2/GFESuite/exportgrids directory.

### **T.6 IFPS Service Backup in AWIPS II**

For AWIPS II, GFE has been reengineered into the GFE perspective in CAVE; as previously discussed, the GFE server applications have been reengineered as EDEX plugins. The AWIPS I Interactive Forecast Preparation System (IFPS) Service Backup Graphical User Interface (GUI) application has been reengineered as a Java application for AWIPS II.

On the LX workstation, Service Backup is accessed from the AWIPS II App Launcher, shown in Exhibit T.6-1 as Start IFPS Service Backup GUI. Alternately, Service Backup can be started on LX stations by entering /awips2/cave/cave.sh -component ServiceBackup at the command prompt.





**Exhibit T.6-1. AWIPS II App Launcher**

When Service Backup starts, the display is similar to Exhibit T.6-2.



**Exhibit T.6-2. AWIPS II Service Backup Application**

## T.7 *Modified Functionality*

In AWIPS I, while in GFE service backup, many sites manipulate their backup site's GFE grids using their own procedures and tools. This allows sites to manage these grids efficiently, using techniques (familiar) to them. In AWIPS I, a common method used to accomplish this was to create and pre-stage a backup GFE user account (i.e., backup\_pub, backup\_gjt...etc). This account would contain all the local GFE tools and procedures that the sites wish to use during service backup. Sites would copy and stage these tools and procedures into their appropriate directories in /awips/GFESuite/primary/data/databases/<backupuser>/. When GFE service backup is invoked, sites would select the appropriate user account (i.e., backup\_pub) to start GFE.

In AWIPS II this functionality can be replicated with the following:

In /awips2/GFESuite/ServiceBackup/configuration/svcbu.properties, modify SVCBU\_USER=1 from the original setting of 0, and SVCBU\_USER\_ID to any generic tester id available on the system.

If the generic user has been created, and the Start GFE option has been selected, GFE will run as the generic user.

Additionally, dual domain sites should set the PRIMARY\_SITES variable to any sites being used as primary, separated by commas in the svcbu.properties to get Service Backup to acknowledge that additional site IDs are primary, and thus allow the export of configuration to the central server correctly. For normal sites, this is not a permitted operation, and the PRIMARY\_SITES variable should be left blank. When PRIMARY\_SITES is blank, the value is defaulted to the AW\_SITE\_IDENTIFIER value. For releases prior to OB13.3.1, invoking Service backup as the National Center requires this command: /awips2/cave/cave.sh -component ServiceBackup -site XXX -nc TRUE. Thereafter Service Backup can be invoked normally without any extra flags.

**Please Note:** As of OB13.5.2, the output directories for export\_grid operations changed to /awips2/GFESuite/exportgrids/primary and /awips2/GFESuite/exportgrids/backup versus the old /awips2/GFESuite/exportgrids and /awips2/GFESuite/exportgrids2, which were previously used by the dual domain sites. Changes were made to the central server script to allow it to differentiate between single and multi-domain sites, and process accordingly.

**Appendix U**  
**AWIPS II Component Categorization**

## Appendix U. AWIPS II Component Categorization

### Table of Contents

	<i>Page</i>
U.1 Introduction.....	1
U.2 Component Categorization .....	1

## U.1 Introduction

AWIPS II provides for the migration of a portion of AWIPS functionality into a new component-based structure. Some AWIPS software applications have been reengineered into CAVE, EDEX, and the Radar Server for AWIPS II, while others were either re-hosted or wrapped. Still others required no modification.

## U.2 Component Categorization

This appendix identifies AWIPS II software applications and categorizes them according to their migration paths. Applying the following definitions, most can be categorized as reengineered, rehosted, wrapped, or untouched:

- **Reengineered.** A *reengineered* application is an application or functionality that has been rewritten from top to bottom. The replacement of an existing functionality with a FOSS (free and open source software) solution is also considered reengineering. Reengineered applications have generally been incorporated into CAVE, EDEX, and the Radar Server. Some data ingest functionality has been replaced by the Local Data Manager (LDM).
- **Rehosted.** A *rehosted* application is one that has been packaged for delivery with the AWIPS II software; it may be executed from CAVE or EDEX, or from an operating system launching mechanism. As a general rule, a rehosted application runs as an independent process; the application being executed is obtained from the latest Operational Build. Rehosted applications generally utilize their own configuration and log files although the configuration files are usually contained in the AWIPS II localization store.
- **Wrapped.** A *wrapped* application or functionality is one that has been incorporated into AWIPS II by means of a bridge (for example, the JEPP Java-Python bridge), between AWIPS II code and pre-AWIPS II code.
- **Untouched.** An *untouched* application (also known as an *unmodified* application) is one that has not been touched. In a few cases (primarily, interactive hydro applications), the application has also been relocated into the EDEX data directory structure; in these cases, the configuration has been moved into the AWIPS II localization store.

### AWIPS II Migration and Component Categorization

AWIPS Application	Acronym	Migration Path to AWIPS II
<b>Hydro</b>		
Metar2shef	HF/MS	Reengineered into a endpoint transformer to the Shef Plug-In
ShefDecoder	HF/SHEF	Reengineered into Shef Plug-In
DPA Processing	HF/DPA	Wrapped into a SOA service end point
GagePP	HF/GPP	Reengineered into Shef Plug-In

### AWIPS II Migration and Component Categorization

AWIPS Application	Acronym	Migration Path to AWIPS II
FloodEvent Archiver	HF/FEA	Rehosted
ReportAlarm	HF/RA	Wrapped into a SOA service and end point activated by Quartz
Data Alert/Alarm Checker	HF/AAC	Reengineered into Shef Plug-In
MPE FieldGenerator	HF/FG	Wrapped into an SOA component activated by Quartz or MPE Editor
File Purge	HF/PF	Wrapped and activated by Quartz
Database Purge	HF/PDB	Wrapped and activated by Quartz
Hydro Point Data Control	HF/PDC	Reengineered into CAVE HydroView Perspective
WHFS Utilities	HF/WU	Wrapped into a library
HydroGen	HF/HG	Rehosted
HydroBase	HF/HB	Reengineered into CAVE HydroView Perspective
HydroView	HF/HV	Reengineered into CAVE HydroView Perspective
TimeSeries	HF/TS	Reengineered into CAVE HydroView Perspective
RiverPro	HF/RPF	Rehosted
Site Specific Hydrologic Predictor	HF/SSHP	Untouched except to activate from CAVE
DamCrest	HF/DC	Untouched except to activate from CAVE
River Monitor/Precip Monitor	HF/RM	Untouched except to activate from CAVE
MPE Editor	HF/MED	Reengineered into MPE CAVE Perspective
Database schema	HY/DBS	Untouched
Database access	HY/DBA	AddedHibernate Object to relational mapping and access
WHFS support functions	HY/UF	Wrapped into Library
Calb	RF/CALB	Rehosted
Distributed Hydrologic Modeling	RF/DHM	Rehosted
Ensemble ENS	RF/ENS	Rehosted
Flash Flood Guidance (FFG)	RF/FFG	Reengineered into CAVE-EDEX plug-ins.
Gribit application	RF/GRIB	Rehosted
Historical Data Browser	RF/HDB	Rehosted
Interactive Calibration Program	RF/ICP	Rehosted
Interactive Double Mass Analysis	RF/IDMA	Rehosted
Interactive Forecast Program	RF/IFP	Rehosted
Operational Forecast System	RF/OFS	Rehosted
OSFDE	RF/OFSDE	Rehosted
Send_RFC	RF/Send_RFC	Rehosted
Util	RF/Util	Rehosted
Verification	RF/VERIF	Rehosted
XDAT	RF/XDAT	Reengineered into CAVE HydroView Perspective
XNAV	RF/XNAV	Rehosted (RFC only application)

### AWIPS II Migration and Component Categorization

AWIPS Application	Acronym	Migration Path to AWIPS II
XSETS	RF/XSETS	Rehosted
SHEF Decoder for RAX	RAX/SHEF	Rehosted
RAXUM	RAX/RAXUM	Rehosted
<b>GFE</b>		
ifpServer	GF	Reengineered into EDEX Plug-In and EDEX service
IFPS Data Server	GF	Reengineered into EDEX Plug-In and EDEX service
GFE Graphical Forecast Editor	GF	Reengineered into CAVE Perspective
Common Libraries	GF	Reengineered
Smart Tools	GF	Ported Baseline Tools to run in CAVE
Text Formatters	GF	Ported Baseline Formatters to run in CAVE including auto testing
Other GFESuite Program	GF	Reengineered (iscNetCDF, ifpImage, ...)
Data	GF	Stored in HDF5
<b>WFO-A</b>		
GEO Datasets	WF	Reengineered into postgisSQL tables
InteractiveDepict	WF	Reengineered into CAVE resources
Monitoring/Control	WF	Replaced with JMX
CommsRouter	CO	Replaced with EDEX ESB
Data Controller	CO	Replaced with EDEX ESB
Data Mgmt Message	CO	Replaced with EDEX ESB
Monitor	CO	Replaced with EDEX ESB
Notification Server	CO	Replaced with EDEX ESB
Radar Ingest	RD	Replaced with Java Radar Server
Radar Applications	RD	Reengineered into CAVE D2D Perspective
Radar Display	RD	Reengineered into CAVE D2D Perspective
WarnGen	WG	Reengineered into CAVE D2D Perspective with velocity templates
Graphic Workstation	GW	Reengineered into CAVE D2D Perspective
WFO Archive Server	WAX	Replaced with NAS raw archive
Local Storm Reporting	LR	Reengineered into CAVE
BUFR Model Output Statistics MOS	BM	Reengineered into EDEX Plug-In
NWR Editor	NE	Rehosted
Web Dissemination	WD	No longer part of AWIPS
IFPS	IF	Reengineered into EDEX Plug-In
ADAPPT Foundation Software	MN	Reengineered into EDEX
Climate Software	CL	Rehosted
Hourly Weather Roundup (HWR)	HR	Rehosted
NWWS		Rehosted
LDAD Software	LD	Reused with added interfaces to AWIPS-II
NCF Enterprise Management	EI	Untouched
AWIPS Foundation Software	AF	Overcome by EDEX ESB

### AWIPS II Migration and Component Categorization

AWIPS Application	Acronym	Migration Path to AWIPS II
Freeware Software	PS	New AWIPS-M set
Commercial Off-the Shelf (COTS)	CS	Untouched
Asynchronous Scheduler	ASY	Untouched except to reconfigure and interface to AWIPS-M
Text Database System	DB	Reengineered into EDEX Plug-In
Decoding	DE	Reengineered into EDEX Plug-In
Hydro Point Data Control	HPD	Reengineered into CAVE HydroView Perspective
Localization	LOC	Reengineered to be dynamic rather than defined at install time
Message Handling System (MHS)	MH	Untouched with new Java interface API
Satellite Decoding and Display	ST	Reengineered into EDEX Plug-In and CAVE Plug-In
Text Workstation	TW	Reengineered into EDEX Plug-In and CAVE Plug-In
WAN Msg Handling	WMH	Untouched with new Java interface API
NWS Site Specific Forecasts	NWS SPOT	Untouched
Legal Archiver	LGL	Untouched
FXA file system		Controlled by install but internal structure unchanged
IFPS Service Backup Central Server	ISB	Untouched
Chatserver - 12Planet		Untouched
Test Mode Control Program (tmcp)		Reengineered
AvnFPS	AV	Reengineered into EDEX Plug-In and CAVE Plug-In
Flash Flood Monitoring FFMP	FF	Reengineered into EDEX Plug-In and CAVE Plug-In
WWA to NWR	WW	Removed from AWIPS
Local MOS (LAMP)	LM	Removed from AWIPS
Pre-LAMP Subsystem	PL	Removed from AWIPS
SCAN	SC	Reengineered into EDEX Plug-In and CAVE Plug-In
SNOW	SN	Reengineered into EDEX Plug-In and CAVE Plug-In
SAFESEAS	SS	Reengineered into EDEX Plug-In and CAVE Plug-In
LAPS	LS	Rehosted by GSD to run with AWIPS-M interfaces
MSAS		Rehosted by GSD to run with AWIPS-M interfaces
FOG (Fog Monitor)	FOG	Reengineered into EDEX Plug-In and CAVE Plug-In
Rapid SCAN	RSC	Reengineered into EDEX Plug-In and CAVE Plug-In
NWRWAVES	NW	Rehosted
4D Stormcell (FSI)	FSI	Untouched
HazCollect		Rehosted and send notifications to AlertViz
Guardian	GDN	Reengineered into AlertViz
Digital Mesocyclone Display	DMD	Reengineered into CAVE and RadarServer
Marine Weather Warning (MWW)	MWW	Port to AWIPS-M



**AWIPS II Migration and Component Categorization**

<b>AWIPS Application</b>	<b>Acronym</b>	<b>Migration Path to AWIPS II</b>
Degrib		Reengineered into EDEX Plug-In with NCEP decoder
NDFD		Untouched
D2D Station OBS Viewer, Point Data Control		Reengineered into CAVE hydroview perspective
Time of Arrival	TOA	Reengineered into CAVE D2D perspective tool
GFE ISC	ISC	Reengineered into EDEX GFE plug-in and CAVE plug-in

**Appendix V**  
**Using D2D Gridded Datasets in GFE**

## Appendix V. Using D2D Gridded Datasets in GFE

### Table of Contents

	<i>Page</i>
V.1 Introduction.....	1
V.2 Create a parameterInfo XML File.....	1
V.3 Add Any New Parameters Names to gfeParamName.xml .....	4
V.4 Add Any New Levels to gfeLevelMappingFile.xml.....	4
V.5 Add Your New parameterInfo File to gfeParamInfo.xml .....	5
V.6 Add Any Accumulative Parameters to D2DAccumulativeElements.....	5
V.7 Add the New Model to D2DMODELS.....	6
V.8 Getting D2D data into GFE flowchart .....	6

### List of Tables

Table V.1-1. Conventions and Variables Used in This Appendix.....	1
Table V.2-1. Convert CDL to XML Information.....	2
Table V.2-2. parameterInfo Format .....	3

## V.1 Introduction

This appendix provides an overview of the use of D2D Gridded Datasets in GFE. Once the user's gridded data is ingesting and visible via the Product Browser in D2D, the user can set up access to this data from GFE by using the information presented here.

This appendix covers the creation of a parameterInfo XML file, the addition of new parameter names to the gfeParamName.xml, the addition of new levels to the gfeLevelMappingFile.xml, the addition of a new parameterInfo file to gfeParamInfo.xml, the addition of accumulative parameters to D2DAccumulativeElements, and the addition of the new model to D2DMODELS.

**Note:** Ingest of non-baseline GriB datasets is outside the scope of this appendix.

Certain conventions and variables are used throughout this appendix. Table V.1-1 details these conventions and variables, and defines any globally applicable information.

**Table V.1-1. Conventions and Variables Used in This Appendix**

Convention	Description
<b>Commands to be Executed</b>	Commands are in Courier New font face and are assumed to be executed on a single line (although formatting conventions and command length might cause commands to wrap to a new line in this document).
<b>CCC</b>	This identifies the AW_SITE_IDENTIFIER under which EDEX is running as defined in /awips2/edex/bin/setup.env, i.e., the "localization" regardless of the GFE_DOMAINNAME.  For dual-domain sites, the configurations are to be placed in the AW_SITE_IDENTIFIER site-level localization tree and not in the GFE_DOMAINNAME.
<b>Site Level Overrides</b>	All files are complete overrides; that is, copy the file(s) from its base location to site and edit the base file making your additions. Do not create empty files under the site as this will affect base definitions. There are DRs to create/append overrides.  Also, all JVMs on all EDEX Processing Servers are required to be bounced after changes are made. Testing can be done by bouncing a single EDEX Processing Server's JVMs and running a smartInit with the <b>-h dx3</b> flag (or other EDEX Processing Server taken as the flag's argument) to not pass through the edexCluster and ensure utilization of the new caches created by the edits. However, all EDEX Processing Servers are required to be updated for new model data ingest and automatic smartInit running.

## V.2 Create a parameterInfo XML File

```
/awips2/edex/data/utility/edex_static/base/grid/parameterInfo
/awips2/edex/data/utility/edex_static/site/CCC/grid/parameterInfo
```

This file is usually given a name that is similar to the datasetID of the D2D dataset with which it is associated; however, it is actually associated with the datasetID by the gfeParamInfo.xml file (see section V.4).

The parameterInfo files contain information that was in the .cdl/.cdf files in AWIPS I.

- If you have a .cdl file from AWIPS I, you can use the **convertCDL2XML** utility to create your parameterInfo file. To convert a pre-existing AWIPS I CDL file into an AWIPS II XML, follow the steps in Table V.2-1.

**Table V.2-1. Convert CDL to XML Information**

Step	Action(s)
<b>Locate the CDL to convert</b>	Most non-baseline (site-specific) CDL files are in <b>/data/fxa/customFiles</b> but they may also be in <b>/awips/fxa/data</b> . A simple find command similar to <code>find /awips/fxa -name "*.cdl"</code> can be performed to locate any files. Note that <b>/awips/fxa</b> is a local mount and most likely any AWIPS I CDL files were stored on DX3/DX4 where a grids localization would have been executed.
<b>Copy files to a staging directory</b>	The easiest approach is to stage the CDL files; however, you can also simply provide the location in AWIPS I as an argument to the conversion utility, as well as the output directory for the XML, when running the script in the next step. Typically, a good location is <b>/localapps</b> to ensure retention of files.
<b>Run the conversion utility</b>	<p>The <b>convertCDL2XML</b> exists anywhere that the <b>awips2-cli- \${RELEASE}</b> RPM is installed and the script resides in <b>/awips2/fxa/bin</b>. The <b>ncgen</b> utility is required for the script to run, which is provided with the <b>netcdf</b> base RedHat RPM on most systems. If any requirement for the script to run is not present, the script will exit and report the error.</p> <p>To run the script (assuming that the CDL files to be converted were copied to <b>/localapps/CDL2XML</b> and you have changed directories into <b>/localapps/CDL2XML</b>):</p> <pre data-bbox="672 1276 1419 1304">/awips2/fxa/bin/convertCDL2XML -f /localapps/CDL2XML</pre> <p>Simply running the <b>convertCDL2XML</b> without any arguments or with the <b>-h</b> flag will report back syntax and arguments. The default output directory will be <b>`pwd`/convertedCDL</b> (where <b>'pwd'</b> is the directory in which the shell is currently running when the script is executed), passing the <b>-o</b> flag followed by an output directory to which the converted XML file will be stored; for example, <b>-o /data/local</b> will put the AWIPSII XML converted by the script into <b>/data/local</b> and not <b>'pwd`/convertedCDL</b>.</p>
<b>Verify and copy the XML</b>	<p>It is good practice to verify that the XML was created properly. In most instances it will be correct. However, if the CDL is sufficiently unique (various levels for certain parameters, for example) then some XML entries may be handled improperly by <b>ncgen</b>. If you notice instances where CDL files are not handled properly, open a ticket with the NCF. Verify the XML against the <u><a href="#">parameterInfo Format shown in Table V.2-2.</a></u></p> <p><b>Note:</b> Copy the XML file from the <b>convertedCDL</b> output directory to the proper location, <b>edex_static/site/grid/parameterInfo</b></p>

- If you do not have a CDL file, just copy one of the baseline parameterInfo files and use it as a template. These files are located in **edex\_static/base/grid/parameterInfo**.

Regardless of whether you are using the **convertCDL2XML** utility or copying a baseline XML parameterInfo file as a template, the file requires some important tags. These tags are shown in Table V.2-2.

**Table V.2-2. parameterInfo Format**

XML Tag	Description
<fcst>	<p>These tags define the forecast times for the model in seconds relative to the model reference time.</p> <p>There should be one tag for every forecast time you wish to use in GFE.</p> <p><b>Note:</b> Upstream of OB13.3.1-21, the &lt;fcst&gt; tag is now mandatory in the parameterInfo for all datasets and for all forecast hours that may be required in GFE. This is true regardless of whether or not they exist in the GriB data.</p> <p>(See section V.4 for more information.)</p>
<short_name>	<p>This tag defines the parameter name as it will be seen in GFE (e.g., in WxElementBrowser using IFP as source). It is associated the D2D parameter name via the gfeParamName.xml file. (See section V.3 for more information.)</p>
<units>	<p>This tag defines the units of the ingested data and should normally match the value from postgres. This unit string must be parsable by the javax.measure.unit.</p> <p>You can use the following SQL query to determine the appropriate unit string for a parameter while connected to dx1f:</p> <pre>psql -U awips -d metadata -c "SELECT (abbreviation,unit) FROM parameter ORDER BY abbreviation"</pre> <p>You can also use various other SQL statements to determine units for individual parameters; for example, to determine units for potential vorticity abbreviations, use:</p> <pre>psql -U awips -d metadata -c "SELECT (abbreviation,unit) FROM parameter WHERE abbreviation ilike '%pv%' ORDER BY abbreviation"</pre>
<valid_range>	<p>This pair of tags defines the minimum and maximum valid values for the parameter.</p> <p>Values outside this range will be clamped to the min/max value.</p>
<fillValue>	<p>This tag defines the value in the grid that will be used as the “no data” value.</p> <p>This value would normally lie outside the range of valid values.</p>
<level>	<p>This tag defines the level names of the data that will appear in GFE. They are associated with the actual D2D level values by the gfeLevelMappingFile.xml (see section V.4).</p>

### V.3 *Add Any New Parameters Names to gfeParamName.xml*

/awips2/edex/data/utility/common\_static/base/parameter/alias  
 /awips2/edex/data/utility/common\_static/site/CCC/parameter/alias

Entries in this file are of the form:

```
<alias base="d2dname">gfename</alias>
```

- If you are adding a new model you can skip this step and the GFE parameter name will be the same as the name of the D2D parameter.
- If you want to use a different name to match existing smartInits/Tools/Procedures you can map your desired GFE parameter name to the D2D parameter name by adding an entry to the gfeParamName.xml file if one does not already exist.

**Note:** These mappings are not tied to a particular dataset so they affect all parameters in all datasets.

### V.4 *Add Any New Levels to gfeLevelMappingFile.xml*

/awips2/edex/data/utility/edex\_static/base/grid  
 /awips2/edex/data/utility/edex\_static/site/CCC/grid

Entries in this file are of the form:

```
<Level key="gfelevel">
  <DatabaseLevel levelName="name" [ levelOneValue="xx" [
    levelTwoValue="yy" ] ]/>
</Level>
```

You can determine the appropriate D2D level values by running the following SQL query against the postgres database (on dx1f) after the model has been ingested.

Replace the value for datasetID below with the modelname being mapped, ETA218 used as an example:

```
psql -U awips -d metadata -c "SELECT parameter_abbreviation,
masterlevel_name, levelonevalue, leveltwovalue from
grid_info, level WHERE level_id=level.id AND
datasetid='ETA218' ORDER BY parameter_abbreviation"
```

- In the decoded D2D data, levels are represented by a level name, and one or two optional numeric values.
- In GFE, levels are represented by a string name.
- The mapping of the GFE string names to D2D levels is contained in gfeLevelMappingFile.xml.
- The levelOneValue and levelTwoValue attributes are optional.

- The GFE level name string can be whatever you desire but is typically of the form:

```
levelName[ levelOneValue [ levelTwoValue ]]
```

### V.5 *Add Your New parameterInfo File to gfeParamInfo.xml*

```
/awips2/edex/data/utility/edex_static/base/grid/parameterInfo
/awips2/edex/data/utility/edex_static/site/CCC/grid/parameterInfo
```

This file associates the parameterInfo XML file with the D2D datasetID.

Entries in this file are of the form:

```
<alias
base="D2DdatasetID">parameterInfoFileName</alias>
```

- Copy the file from base to site and make changes to the site-level file. The base file is located at the following location:

```
/awips2/edex/data/utility/common_static/base/grid/dataset/alias/gfeParamInfo.xml
```

- If a <fcst> tag does not exist for a given forecast time in the gridded dataset's parameterInfo file, missing time steps may be noticed in the grid manager for that particular model.

If all time steps are not displaying in the grid manager for a particular parameter (when compared to the time steps that are available in D2D for that same parameter), check the following to determine if there are missing <fcst> tags in the parameterInfo file.

On an EDEX Processing Server (e.g., DX3, DX4, DX5, DX6):

```
grep 'No time range found for' /awips2/edex/logs/edex-
ingest-smartInit-`date +%Y%m%d`.log | awk '{print
$13}' | cut -d_ -f5 | uniq
```

Any dataset returned references the GFE model name mapped in the D2DMODELS array in the localConfig.py for the active GFE domain.

Assuming that the above grep command returned {MODELNAME} you can then determine the <fcst> hours that are missing via the following:

```
grep 'No time range found for' /awips2/edex/logs/edex-
ingest-smartInit-`date +%Y%m%d`.log | grep
${MODELNAME} | awk '{print $17}' | sort -n | uniq
```

Then add these values inside the <fcst> </fcst> XML tag in the appropriate parameterInfo file.

### V.6 *Add Any Accumulative Parameters to D2DAccumulativeElements*

These would be defined in your localConfig.py file.



- This setting indicates to GFE that the associated D2D parameter is an accumulative element and will change how GFE determines the time range associated with the forecast hours.
- To add parameters for a new model the entry should have the following form:
 

```
serverConfig.D2DAccumulativeElements["GFEmodelName"]=["parm1", "parm2", ...]
```
- To add more parameters for an existing model, the entry should have the following form:
 

```
serverConfig.D2DAccumulativeElements["GFEmodelName"]=["parm1", "parm2", ...]
```

### V.7 *Add the New Model to D2DMODELS*

These would be defined in your localConfig.py file.

This setting associates the D2D datasetID with the desired GFE model name.

```
serverConfig.D2DMODELS.append(('D2DdatasetID', 'GFEmodelName'))
```

**Note:** For reference, the GFE configuration file locations mentioned in this document are as follows:

```
/awips2/edex/data/utility/edex_static/site/CCC/grid/parameterInfo/xxxxx.xml
/awips2/edex/data/utility/edex_static/site/CCC/grid/gfeLevelMappingFile.xml
/awips2/edex/data/utility/common_static/site/CCC/parameter/alias/gfeParamName.xml
/awips2/edex/data/utility/common_static/site/CCC/grid/dataset/alias/gfeParamInfo.xml
/awips2/edex/data/utility/edex_static/site/CCC/config/gfe/localConfig.py
```

All files should be copied from their BASE location to the SITE location before editing.

### V.8 *Getting D2D data into GFE flowchart*

The following exhibit V.8-1 illustrates how to get the D2D data into GFE in AWIPS II.

Exhibit. V.8-1: How to get Data into GFE in AWIPS II

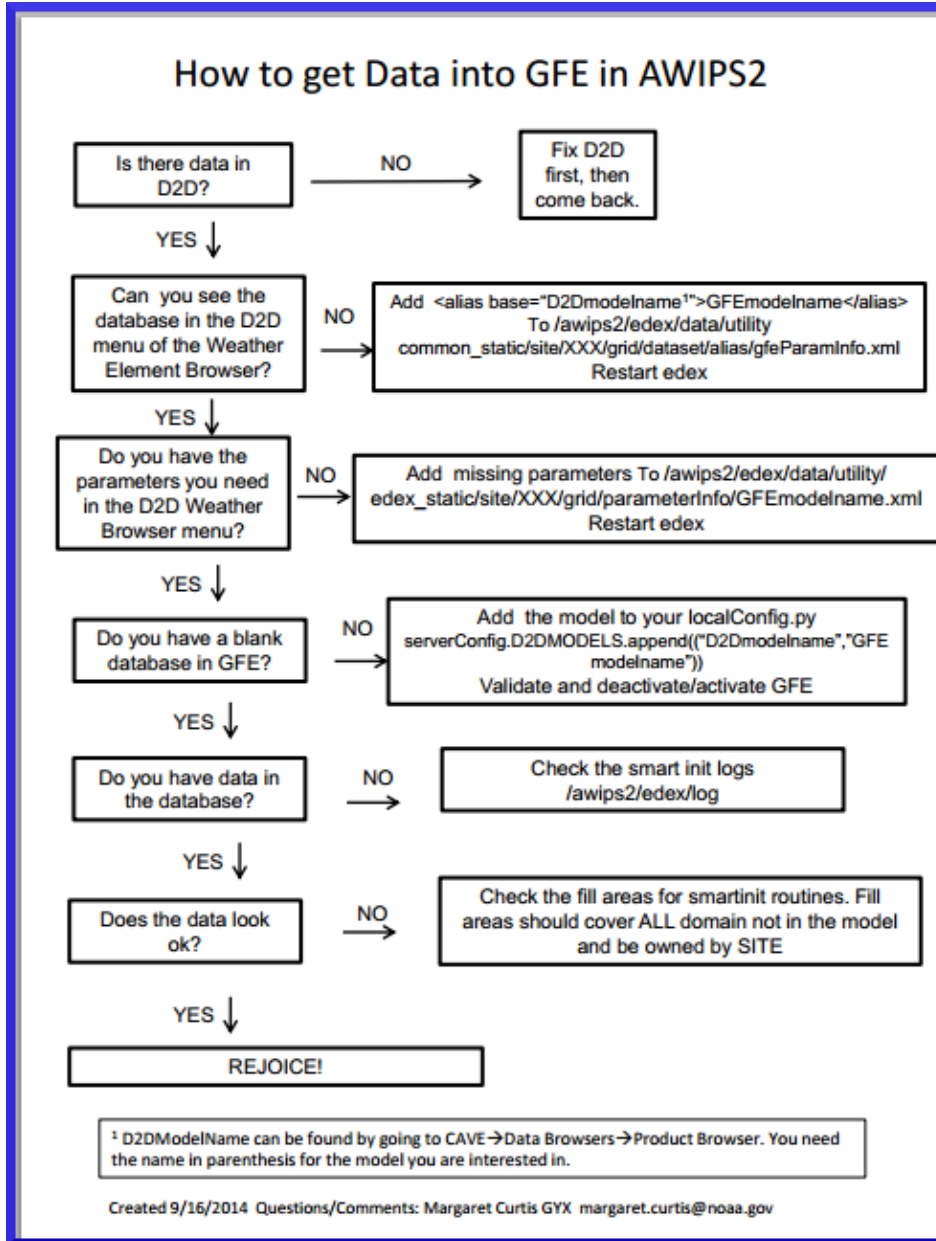

**Appendix W**  
**WarnGen Urban Boundaries**

## Appendix W. WarnGen Urban Boundaries

### Table of Contents

	<i>Page</i>
W.1 Introduction.....	1
W.2 Reserved.....	1
W.3 Shape File Installation.....	1
W.3.1 Base-Level Shape File Installation.....	2
W.3.2 Verify the WarnGenLoc Installation.....	3
W.4 Urban Boundaries Specific Template Information .....	4
W.4.1 General Background .....	4
W.4.2 WarnGenLoc Shape File Fields .....	5
W.4.3 Template Configuration Fields .....	5
W.4.4 Filters and Constraints .....	7
W.4.5 Third Bullet Example.....	7
W.4.6 Fourth Bullet Example.....	9

### List of Tables

Table W.4.2-1. WarnGenLoc Shape File Fields.....	5
Table W.4.3-1. Template Configuration Fields .....	6
Table W.4.3-2. Template Configuration Fields .....	6
Table W.4.4-1. Constraint Values Use to Control Filters.....	7
Table W.4.4-2. Landwater Field Values Used to Control Locations in Land and Marine Products .....	7

## **W.1 Introduction**

The Urban Boundaries functionality allows more accurate and detailed city information in the WarnGen third and fourth bullets.

Each site needs the following three pieces of software to implement the WarnGen Urban Boundaries functionality:

1. WarnGen source code changes
2. Installation of the WarnGenLoc shape file (the shape file is not delivered with the AWIPS software release; sites can complete this step at any time).
3. Activation of the new WarnGen templates (after the WarnGenLoc shape file is installed).

Generally, these three pieces are all independent of one another. Installing the WarnGenLoc shape file does not affect anything in AWIPS II. WarnGen is the only application that uses the WarnGenLoc shape file.

**Note:** This appendix describes the configuration in the AWIPS II clustered (operational) environment. Some modifications will be needed on the ADAM system. An updated version of this document is maintained on the WarnGen Template wiki at the following location: <https://collaborate.nws.noaa.gov/trac/siteconfig/wiki/WarnGenUrbanBoundsInfo>

## **W.2 Reserved**

## **W.3 Shape File Installation**

The new WarnGenLoc shape file defines the location information for WarnGen. The shape file set is available on the NOAA1 server in the pub/maps/currentBaseline directory with file names wgddmmyy.\* where “ddmmyy” is the day month year of the shape file creation. Three files are needed; the file extensions are “dbf”, “shp” and “shx”. Be sure to download the newest version of the shape file set. New versions of the shape file will be released periodically to correct minor errors found as more WFOs continue testing AWIPS II.

**Note:** The above files are very large and may take a long time to download.

### W.3.1 Base-Level Shape File Installation

#### STEP 1: Verify the base-level Configuration

If WarnGenLoc was previously installed at the site level for QC/testing, the site level staging directory overrides the base and must be removed. No PostGres change is needed since the same table name and schema are used. If it exists, remove the following site level staging directory and all its contents from the EDEX server:

```
/awips2/edex/data/utility/edex_static/site/LLL/shapefiles/WarnGenLoc
```

Verify that the following base level staging directory exists on the EDEX server:

```
/awips2/edex/data/utility/edex_static/base/shapefiles/WarnGenLoc
```

This directory likely will not exist on the ADAM box. If the directory does not exist, create it (owner: group should be awips:fxalpha, permissions 775).

#### STEP 2: Copy the WarnGenLoc Shape Files

Copy all three of the wgddmmyy.\* files into directory **/data/fxa/nationalData**

**Note:** The downloaded shape file name (e.g., wgddmmyy.\*) **MUST** be maintained.

On ADAM (as root), scp the shape files from dx1 to adam1:/data/fxa/nationalData because this is not mounted on ADAM.

#### STEP 3: Install the WarnGenLoc Shape Files

On the operational system (as root):

```
ssh dx1f
cd /data/fxa/sdc
./config_awips2.sh shp LLL
```

where **LLL** is the site identifier for your AWIPS system (all CAPS)

On ADAM (as root):

```
ssh adam1
cd /var/tmp/sdc
./config_awips2.sh shp LLL
```

where **LLL** is the site identifier for your AWIPS system (all CAPS)

The config\_awips2.sh script may prompt for each new shape file found. If shape files other than WarnGenLoc are found, enter “N” until prompted for WarnGenLoc. The script will take a few minutes; it will return with “Complete” notification when done. The script copies the shape file set from nationalData to the staging directory.

### W.3.2 Verify the WarnGenLoc Installation

Check Postgres to verify that the shape file was stored by performing the following steps. Complete these steps as a normal Linux user:

1. **ssh to dx1f** (if on ADAM, **ssh adam1**)
2. **psql -d maps** (enter the password)
3. **select \* from mapdata.map\_version where table\_name like 'warnngen%';**
4. **\q** (exit psql).

The following fields should display from the mapdata.map\_version table:

- table\_name: warnngenloc
- filename: WarnGenLoc.shp
- import\_time: date and time when config\_awips2.sh was run

Some other useful psql commands for viewing the WarnGenLoc fields are the following.

To view the WarnGenLoc field names:

**TYPE:**    \d mapdata.warnngenloc

To list some important WarnGenLoc data values (in this example, for WFO LWX):

**TYPE:**    select cwa, name, state, warnngenlev, population, usedirs,  
              supdirs, landwater from mapdata.warnngenloc where cwa='LWX'  
              order by state, name asc;

Verify that the shape file can be displayed in CAVE by executing the following steps:

1. Launch CAVE.
2. In the D2D perspective, select MAPS -> WarnGenLoc (or the local menu item ).
3. Zoom to your area of interest.
4. Right click on the map; select "Show Map Legends" to display the map legends.
5. Right click on the WarnGenLoc map label.
6. Select "shade" and choose the field to shade (e.g., name). The polygons should be shaded.
7. Right click on the WarnGenLoc map label.
8. Select label and choose the field to label (e.g. name). The location names should display.
9. The labels can be made easier to read by increasing the magnification and changing the color of the label.

To display the shape file on CAVE, the following warnngenloc map bundle is required on the EDEX server:

**[/awips2/edex/data/utility/cave\\_static/site/LLL/bundles/maps/warnngenloc.xml](#)**

If the WFO needs to make corrections to the urban boundaries shape file, they should follow the instructions from the WarnGen wiki at the following location:

**<https://collaborate.nws.noaa.gov/trac/siteconfig/wiki/warnGenShapefileQC>**

#### ***W.4 Urban Boundaries Specific Template Information***

This section describes the urban boundaries-specific template information needed for the sites.

##### ***W.4.1 General Background***

This section describes the WarnGen template logic that uses the new WarnGen locations shape file (WarnGenLoc). Many of the items are site configurable. Configurations described here are the baseline template configurations.

The WarnGenLoc items are used in the third and fourth bullets of WarnGen products with a storm track. These are the third bullet current storm location and the fourth bullet pathcast or list of cities. In general, the WarnGen hydrologic products will only use the WarnGenLoc items in the fourth bullet.

The urban boundaries functionality replaces the legacy AWIPS local cities and marine sites functionality. Highway mile markers are treated as simple point locations and are coded in a separate section after the fourth bullet and above the CTA section. Mile marker configuration is a separate topic and is covered on the WarnGen wiki at the following location:

**<https://collaborate.nws.noaa.gov/trac/siteconfig/wiki/AddingMileMarkers>**

Another type of WarnGen location data is Point Markers. These are intended for temporary locations such as specific events (e.g., festivals and races). These are NOT included in the WarnGenLoc nationwide urban boundaries shape file. They are added to a different Postgres database table maintained by the site. Point marker configuration is detailed on the WarnGen wiki at the following link:

**<https://collaborate.nws.noaa.gov/trac/siteconfig/wiki/AddingPointMarkers>**

Each WarnGenLoc item can be treated as a polygon or as a single point. As a result, portions of the cities can be specified in the third bullet current storm position.



**IMPORTANT:** The portions of the cities are used in the third bullet ONLY if the WarnGenLoc shape file field "usedirs" is set to "1" (TRUE). Most locations will not use portions; therefore, WarnGen will treat them as simple point locations. For example, to reference "NORTHERN DENVER", the Denver userdirs value must be "1". If the Denver usedirs value is "0", then WarnGen will only refer to "DENVER" without any portions of the city in the third bullet storm location.

#### W.4.2 WarnGenLoc Shape File Fields

Table W.4.2-1 briefly defines the WarnGenLoc Shape File Fields. They are described in more detail in the WarnGenLoc QC section on the WarnGen wiki at the following link:

<https://collaborate.nws.noaa.gov/trac/siteconfig/wiki/warnGenShapefileQC>

**Table W.4.2-1. WarnGenLoc Shape File Fields**

Field	Description
Gid	System-assigned unique ID number
Name	Location name
St	State abbreviation
State	Full state name
Population	2010 Census population, where available
Warngenlev	WarnGen priority levels from AWIPS I
Cwa	CWA 3 letter ID
Goodness	Controls zoom level when location appears on CAVE
Lat	Latitude of location centroid
Lon	Longitude of location centroid
Usedirs	1=use portions of the location (e.g. NORTHERN DENVER), 0=use no portions
Supdirs	Suppress these directions when usedirs=1 (values are NSEW or any combination with no delimiters)
Landwater	codes to distinguish land and water locations
Recnum	system assigned ID number unique for this CWA
the_geom	binary geometry data

#### W.4.3 Template Configuration Fields

The configuration items that control the selection of the third and fourth bullet cities are in the template xml file. Each xml section defines Java software objects that contain all the parameters needed to control the behavior of each object. Table W.4.3-1 identifies and defines the template objects related to configuring the urban boundaries functionality.

**Table W.4.3-1. Template Configuration Fields**

Field	Description
areaSource object "areas"	Generates list of counties or zones in the first bullet.
pointSource object "closestPoints"	Generates the first city listed in the third bullet storm location.
pointSource object "otherClosestPoints"	Generates the "other" city listed in the third bullet storm location.
pathcastConfig	Specifies the general pathcast configuration
pointSource object "cityList"	Generates the fourth bullet locations in the list of cities and the pathcast.
pointSource object "otherPoints"	Generates the fourth bullet other locations (only used for the pathcast).
geospatialConfig	Specifies whether the product codes counties, forecast zones or marine zones.

Table W.4.3-2 identifies and briefly describes some of the important WarnGenLoc-related configurations. More detailed descriptions can be found in the WarnGen Velocity Documentation on the WarnGen wiki at the following link:

<https://collaborate.nws.noaa.gov/trac/siteconfig/wiki/WarnGen>

Scroll to the section titled AWIPS 2 WarnGen Documentation and Localization, and select the link for "Current WarnGen Velocity Documentation."

**Table W.4.3-2. Template Configuration Fields**

Configuration	Description
City inclusion	Defines how much of the location must fall within the warning polygon to be included in the warning. If set to zero, locations with boundaries barely touching the warning polygon will be included. These are the fields inclusionPercent, inclusionArea, and inclusionAndOr. They apply to both counties/zones in the first bullet and cities in the third bullet (only larger cities with userdirs = "1").
City position relative to the storm	Locations can be chosen according to distance from the storm centroid or distance from the storm track (fields searchMethod, distanceThreshold).
City filters	Used to select desired locations such as the warngenlev (AWIPS ONE WarnGen priority) and the landwater fields.
Number of cities	Refers to the number of locations; can be limited using the maxResults field.
Polygon	withinPolygon field can be set to 'false' to allow reference locations outside the warning polygon.
Pathcast	Various pathcast aspects can be configured such as the first pathcast entry, time interval, number of locations at each time and total number of time intervals (fields delta, interval, maxCount and maxGroup).
Watches	IncludeWatchAreaBuffer field sets the area within which nearby watch information will be included.
Counties vs. zones	geospatialConfig and areaSource can be used to list counties in the first bullet of zone-based products.

#### W.4.4 Filters and Constraints

Constraint values control the filters. The valid constraints are identified in Table W.4.4-1.

**Table W.4.4-1. Constraint Values Use to Control Filters**

Constraint	Description
EQUALS	Matches exactly the constraint value (only one value should be supplied)
NOT_EQUALS	Does not match exactly the constraint value
GREATER_THAN	Greater than the constraint value
GREATER_THAN_EQUALS	Greater than or equal to the constraint value
LESS_THAN_EQUALS	Less than or equal to constraint value
BETWEEN	Range value set in constraint value (constraint value must be in the format of "a--b")
IN	True if one of the values in the constraint value. constraint values separated by commas (i.e., L,LW,W)
LIKE	True if one of the values contains a value that contains the constraint value <b>(BEWARE: THIS MAY AFFECT PERFORMANCE)</b>

The landwater field values from the WarnGenLoc shapefile are used to control locations in land and marine products. These values are identified in Table W.4.4-2.

**Table W.4.4-2. Landwater Field Values Used to Control Locations in Land and Marine Products**

Landwater Field Value	Description
L	Land only (default value for AWIPS I LocalCitiesInfo file and cities shapefile)
W	Marine only, for use in the third bullet (storm location) and fourth bullet (pathcast) of SMW and MWS products (this is the default value for locations from the AWIPS I MarineInfo file).
C	Used only as reference points in the 3rd bullet of SMW and MWS products
LW	Combo of "L" and "W" (use land location as 3rd or 4th bullet marine reference)
LC	Combo of "L" and "C" (use land location as 3rd bullet marine reference point)

The following are the required landwater values for WarnGen products. These are the baseline template coded values:

- LAND PRODUCTS: third bullet - L, LW, LC and fourth bullet - L, LW, LC
- MARINE PRODUCTS third bullet - W, C, LW, LC and fourth bullet - W, LW

#### W.4.5 Third Bullet Example

This section lists the template xml configuration that controls the selection of locations in the third bullet storm location. These items are in file geospatialConfig\_COUNTY.xml:

```
<!-- CREATE pointSource OBJECT TO GENERATE LIST OF CLOSEST POINTS TO
DOT (3RD BULLET) -->
<!-- type = AREA allows us to use multi-polygonal shapefiles despite
the pointSource misnomer -->
```

```

<pointSource variable="closestPoints">
  <pointField>NAME</pointField>
  <type>AREA</type>
  <searchMethod>POINTS</searchMethod>
  <maxResults>1</maxResults>
  <distanceThreshold>100</distanceThreshold>
  <filter>
    <mapping key="WARNGENLEV">
      <constraint constraintValue="1,2" constraintType="IN"
/>
    </mapping>
    <mapping key="LANDWATER">
      <constraint constraintValue="L,LW,LC" constraintType="IN" />
    </mapping>
  </filter>
  <sortBy>
    <sort>distance</sort>
    <sort>warngenlev</sort>
    <sort>population</sort>
  </sortBy>
</pointSource>

<!-- CREATE pointSource OBJECT TO GENERATE LIST OF SECONDARY POINTS TO
DOT (3RD BULLET)
...OR ABOUT XXX MILES FROM LARGER KNOWN LOCATION -->
<pointSource variable="otherClosestPoints">
  <pointField>NAME</pointField>
  <type>AREA</type>
  <searchMethod>POINTS</searchMethod>
  <maxResults>5</maxResults>
  <distanceThreshold>100</distanceThreshold>
  <filter>
    <mapping key="WARNGENLEV">
      <constraint constraintValue="1" constraintType="IN" />
    </mapping>
    <mapping key="LANDWATER">
      <constraint constraintValue="L,LW,LC" constraintType="IN" />
    </mapping>
  </filter>
  <sortBy>
    <sort>distance</sort>
    <sort>warngenlev</sort>
  </sortBy>
</pointSource>

```

In the preceding third bullet example, the closestPoints object returns warngen level one or two land locations within 100 miles of the current storm location, sorts by distance, warngenlev and population and returns at most one location. This is the first location coded in the third bullet.

The storm location is the WarnGen estimated storm location when “create text” is used. It is not the storm centroid at the time of the latest radar frame.

The distance to the storm location is measured from the city centroid (lat/lon in the WarnGenLoc). If the storm location falls within an urban boundary (i.e. “drag me to storm” is within the city polygon), the effective distance/direction becomes zero and a portion of the city will be used if useDirs is “1.”

When the storm distance is  $\leq 2$  miles, the template codes "OVER" the city. When the distance is  $> 2$  miles and  $\leq 6$  miles, the template codes "NEAR" the city. When the distance is  $> 6$  miles, the template codes a direction and distance.

The otherClosestPoints object returns warngen level one land locations within 100 miles of the current storm location, sorts by distance, warngenlev and returns at most five locations. The closest location is used as the "other" city in the third bullet. This is the closest level one city to the storm location.

In the following third bullet example, closestPoints provided Westminster and otherClosestPoints provided Downtown Denver:

```
AT 1206 PM MDT . . . DOPPLER RADAR INDICATED A SEVERE
THUNDERSTORM CAPABLE OF PRODUCING DAMAGING WINDS IN EXCESS
OF 60 MPH. THIS STORM WAS LOCATED NEAR SOUTHERN WESTMINSTER
. . . OR 8 MILES NORTHWEST OF DOWNTOWN DENVER . . . AND
MOVING NORTHEAST AT 5 MPH.
```

The following city portions are coded (if WarnGenLoc usedirs = 1): NORTHERN, NORTHEASTERN, EASTERN, SOUTHEASTERN, SOUTHERN, SOUTHWESTERN, WESTERN and NORTHWESTERN. Also, the following portions containing CENTRAL are coded: NORTH CENTRAL, EAST CENTRAL, SOUTH CENTRAL, and WEST CENTRAL.

For asymmetrically shaped locations, directional portions can be excluded. This is set in the WarnGenLoc supdirs field. The values are "NSEW" or any combination with no delimiters. For example, "NS" would produce no NORTHERN or SOUTHERN portions for this city.

#### **W.4.6 Fourth Bullet Example**

The fourth bullet can contain a list of cities or pathcast. This section lists the file geospatialConfig\_COUNTY.xml logic that controls the selection of locations in the fourth bullet pathcast:

```
<!-- CREATE pathcastConfig OBJECT FOR PATHCAST (4TH BULLET) -->
<pathcastConfig>
  <type>AREA</type>
  <inclusionPercent>1</inclusionPercent>
  <withinPolygon>true</withinPolygon>
  <distanceThreshold>8.0</distanceThreshold>
  <interval>5</interval>
  <delta>5</delta>
```

```

<maxResults>10</maxResults>
<maxGroup>8</maxGroup>
<pointField>Name</pointField>
<areaField>COUNTYNAME</areaField>
<parentAreaField>STATE</parentAreaField>
<areaNotationField>STATE</areaNotationField>

<areaNotationTranslationFile>countyTypes.txt</areaNotationTranslationFile>
<sortBy>
  <sort>warngenlev</sort>
  <sort>population</sort>
  <sort>distance</sort>
</sortBy>
<filter>
  <mapping key="WARNGENLEV">
    <constraint constraintValue="1,2" constraintType="IN"
  />
  </mapping>
  <mapping key="LANDWATER">
    <constraint constraintValue="L,LW,LC" constraintType="IN" />
  </mapping>
</filter>
</pathcastConfig>

```

The pathcast configuration above specifies that the pathcast begins 5 minutes after the current storm location (delta tag). Locations will be listed at five minute intervals (interval tag). There will be a maximum of eight pathcast intervals (maxGroup tag). Each interval will have a maximum of ten locations (maxResults tag). If no locations are found for a particular time period, then that interval is skipped in the pathcast.

The pathcast contains only level 1 and 2 cities (warngenlev tag) within 8 miles of the storm track (distanceThreshold tag) and within the warning polygon (withinPolygon tag). Only land locations are selected (landwater tag). The location is included if at least one percent of the location polygon is inside the warning polygon (inclusionPercent tag). The inclusion threshold applies only for locations with usedirs set to 1 in the WarnGenLoc shape file. They are sorted by warngenlev, population, followed by the distance from the storm track.

```

<!--CREATE pointSource OBJECT FOR LOWER ORDER CITIES FOR PATHCAST SETTING
(4TH BULLET) -->
  <pointSource variable="otherPoints">
    <pointField>NAME</pointField>
    <inclusionPercent>1</inclusionPercent>
    <type>AREA</type>
    <searchMethod>TRACK</searchMethod>
    <withinPolygon>true</withinPolygon>
    <maxResults>10</maxResults>
    <distanceThreshold>10</distanceThreshold>
    <sortBy>
      <sort>distance</sort>
      <sort>warngenlev</sort>
    </sortBy>

```

```

    <filter>
      <mapping key="WARNGENLEV">
        <constraint constraintValue="3,4" constraintType="IN" />
      </mapping>
      <mapping key="LANDWATER">
        <constraint constraintValue="L,LW,LC" constraintType="IN" />
      </mapping>
    </filter>
  </pointSource>

```

When pathcast is used, “OTHER LOCATIONS IMPACTED” is also coded after the pathcast. The “otherPoints” object contains these locations. These are a maximum of 10 level 3 and 4 locations, ten miles or less from the storm track and within the warning polygon, sorted by distance, warnngenlev from the storm track.

The following section lists the file geospatialConfig\_COUNTY.xml logic that controls the selection of locations in the fourth bullet list of cities:

```

<!--CREATE pointSource OBJECT FOR NON-PATHCAST CITY LIST -->
  <pointSource variable="cityList">
    <searchMethod>TRACK</searchMethod>
    <pointField>NAME</pointField>
    <inclusionPercent>1</inclusionPercent>
    <type>AREA</type>

    <withinPolygon>true</withinPolygon>
    <maxResults>20</maxResults>
    <distanceThreshold>10</distanceThreshold>
    <filter>
      <mapping key="WARNGENLEV">
        <constraint constraintValue="1,2,3,4" constraintType="IN" />
      </mapping>
      <mapping key="LANDWATER">
        <constraint constraintValue="L,LW,LC" constraintType="IN" />
      </mapping>
    </filter>
    <sortBy>
      <sort>warnngenlev</sort>
      <sort>population</sort>
      <sort>distance</sort>
    </sortBy>
  </pointSource>

```

The list of cities contains a maximum of 20 level one, two, three and four locations within the polygon and within 10 miles of the storm track. The location is included if at least one percent of the location polygon is inside the warning polygon. They are sorted by warnngenlev, population, and then distance from the storm track.

The third and fourth bullet logic is similar for the TOR, SVR, SPS, NOW, EWW and SMW products. The hydrologic products generally do not track specific storm cells and do not contain specific storm location and movement information. In general, the hydro products only use the WarnGen locations shape file in the fourth bullet list of affected locations.

**Appendix X**  
**Metar2shef Data Conversion Process**  
**Elements, Tokens and Files**



## Appendix X. Metar2shef Data Conversion Process Elements, Tokens and Files

### Table of Contents

	<i>Page</i>
X.1 Metar2shefFilter File XML Elements .....	1
X.2 Examples of Metar2shef Filter Files .....	2
X.3 Metar2shef Configuration File.....	4
X.4 The metar2shef_options Token.....	7

### X.1 *Metar2shefFilter File XML Elements*

**Note:** Please refer to Chapter 6, Sections 6.4.4 Metar2Shef Data Processing, 6.4.5 Metar2Shef Filters, 6.4.6 Metar2Shef Configuration File, 6.4.7 Metar2Shef Options and 6.4.8 Metar2Shef Logging for various Metar2Shef options.

There are 2 main types of XML filter files, differentiated by their root elements: one contains a **pluginDataObjectFilter**, the other contains a **metarToShefFilter**. They share most of the other elements listed below:

1. **<pluginDataObjectFilter>** : Root element. It should have one or more <filterElements> element(s), and one <filterName> element.
2. **<filterElement>** : There are four types of <filterElement> elements – wmoHeaderFilterElement, stationIdFilterElement, radiusFilterElement, and rectFilterElement. The type of element should be specified in the *open* tag. All filterElements in an element must be matched in order for a station to be processed.
  - a. WmoHeaderFilterElement: This type of <filterElement> element should have one <filterElementName> element, one <filterType> element, and one or more <patterns> element(s).
  - b. stationIdFilterElement: This type of <filterElement> element should have one <filterElementName> element, one <filterType> element, and one or more <patterns> element(s).
  - c. RadiusFilterElement: This type of <filterElement> element should have one <filterElementName> element, one <filterType> element, one <radius> element, one <pointLat> element, and one <pointLon> element.
  - d. RectFilterElement: This type of <filterElement> element should have one <filterElementName> element, one <filterType> element, one <upperLeftLat> element, one <upperLeftLon> element, one <lowerRightLat> element, and one <lowerRightLon> .
3. **<filterElementName>** : Name for this filter. Can be any name.
  - *Example:* <filterElementName> Filter by station ID </filterElementName>
4. **<filterType>** : INCLUDE or EXCLUDE only; specify whether the items selected by this filter are to be included in or excluded from processing.
  - *Example:* <filterType> INCLUDE </filterType>
5. **<patterns>** : Pattern(s) to filter a METAR product.
  - a. In a wmoHeaderFilterElement type <filterElement> filter, the pattern(s) are matched against the WMO header of a METAR product.

- b. In a stationIdFilterElement type <filterElement> filter, the pattern(s) are matched against the station IDs contained in the METAR product.
  - c. In a radiusFilterElement type <filterElement> filter, three sets of <patterns> tags are required:
    - <radius> : Radius in nautical miles.
    - <pointLat> : Center Latitude point in decimal degrees.
    - <pointLon> : Center Longitude point in decimal degrees.
  - d. In a rectFilterElement type <filterElement> filter, four sets of <patterns> tags are required:
    - <upperLeftLat> : Upper left latitude in decimal degrees.
    - <upperLeftLon> : Upper left longitude in decimal degrees.
    - <lowerRightLat> : Lower right latitude in decimal degrees.
    - <lowerRightLon> : Lower right latitude in decimal degrees.
6. **<filterName>** : Name for a METAR-to-SHEF run. Can be any name.
- *Example:* <filterName> *Synop METAR to SHEF* </filterName>
7. **<metarToShefFilter>** : Root element. It should have one or more <metarToShefRun> element(s).
8. **<metarToShefRun>** : It should have one <configFileName> element, one <metarToShefOptions> element, one or more (any type combination) <filterElements> element(s), and one <filterName> element.
9. **<configFileName>** : It should have a METAR-to-SHEF configuration file name, located in /awips2/edex/data/utility/common\_static/site/XXX/shef directory. The default is **metar.cfg** if the specified file not found or none is given.
10. **<metarToShefOptions>** : It should have the options for a METAR-to-SHEF conversion, which override those specified by the **metar2shef\_options** token in the *Apps\_defaults* file.

## X.2 Examples of Metar2shef Filter Files

**Note:** In the following examples, highlighting and text color have been added to make it easier to distinguish the various elements.

### A. Root Element: pluginDataObjectFilter

Example -- contents of file /awips2/edex/data/utility/edex\_static/site/PHI/plugin-filters/metarToShefFilter.xml (slightly modified to demonstrate 3 types of filters):

```
<?xml version="1.0" encoding="UTF-8" standalone="yes"?>
  <!--
    Optional comments
  -->
  <pluginDataObjectFilter>
    <filterElements xmlns:xsi="http://www.w3.org/2001/XMLSchema-instance"
xsi:type="wmoHeaderFilterElement">
      <!-- Filter for specific WMO Headers -->
      <filterElementName>PHI.WMOHeaders</filterElementName>
      <filterType>INCLUDE</filterType>
      <patterns>S[AP]US[78]0.*</patterns>
      <patterns>SAUS[1478][01].*</patterns>
      <patterns>SA[NXZ][AXZ][1346][045].*</patterns>
      <patterns>SP[UX][SX][16][07].*</patterns>
      <patterns>SPXXZZ.*</patterns>
    </filterElements>
    <filterElements xmlns:xsi="http://www.w3.org/2001/XMLSchema-instance" xsi:type="rectFilterElement">
      <filterElementName>PHI.WFO</filterElementName>
      <filterType>INCLUDE</filterType>
      <upperLeftLat>47.97172</upperLeftLat>
      <upperLeftLon>-86.21379</upperLeftLon>
      <lowerRightLat>31.97172</lowerRightLat>
      <lowerRightLon>-64.21379</lowerRightLon>
    </filterElements>
    <filterElements xmlns:xsi="http://www.w3.org/2001/XMLSchema-instance"
xsi:type="stationIdFilterElement">
      <filterElementName>PHI_LID</filterElementName>
      <filterType>INCLUDE</filterType>
      <patterns>KJXN</patterns>
    </filterElements>
    <filterElements xmlns:xsi="http://www.w3.org/2001/XMLSchema-instance"
xsi:type="stationIdFilterElement">
      <filterElementName>PHI_Radius</filterElementName>
      <filterType>INCLUDE</filterType>
      <radius>150</radius>
      <pointLat>40.97172</lowerRightLat>
      <pointLon>-75.21379</upperLeftLon>
    </filterElements>
    <filterName>PHI.metarToShefFilter</filterName>
  </pluginDataObjectFilter>
```

## B. Root Element: metarToShefFilter (with 2 “metarToShefRun”s)

Example -- contents of file /awips2/edex/data/utility/edex\_static/site/OAX/plugin-filters/metarToShefFilter.xml (slightly modified to demonstrate multiple metarToShefRun’s):

```
<?xml version="1.0" encoding="UTF-8" standalone="yes"?>
  <!--
```

## Optional comments

```

-->
<metarToShefFilter>
  <metarToShefRun>
    <configFileName>metar.cfg</configFileName>
    <metarToShefOptions>-a -b -p1 -p6 -p24 -round -w -strip</metarToShefOptions>
    <filterElements xmlns:xsi="http://www.w3.org/2001/XMLSchema-instance"
xsi:type="wmoHeaderFilterElement">
      <!-- Filter for specific WMO Headers -->
      <filterElementName>OAX.WMOHeaders</filterElementName>
      <filterType>INCLUDE</filterType>
      <patterns>SAUS70.*</patterns>
    </filterElements>
    <filterElements xmlns:xsi="http://www.w3.org/2001/XMLSchema-instance" xsi:type="rectFilterElement">
      <filterElementName>OAX.WFO</filterElementName>
      <!-- Filter that includes all observations within the Omaha Valley WFO -->
      <filterType>INCLUDE</filterType>
      <upperLeftLat>49</upperLeftLat>
      <upperLeftLon>-100</upperLeftLon>
      <lowerRightLat>40.0</lowerRightLat>
      <lowerRightLon>-80.10</lowerRightLon>
    </filterElements>
    <filterName>OAX.MetarToShef</filterName>
  </metarToShefRun>
  <metarToShefRun>
    <configFileName>metar.cfg1</configFileName>
    <metarToShefOptions>-a -b -p1 -p6 -p24 -round -w -strip -v</metarToShefOptions>
    <filterElements xmlns:xsi="http://www.w3.org/2001/XMLSchema-instance"
xsi:type="wmoHeaderFilterElement">
      <!-- Filter for specific WMO Headers -->
      <filterElementName>OAX.WMOHeaders</filterElementName>
      <filterType>INCLUDE</filterType>
      <patterns>SAUS80.*</patterns>
    </filterElements>
    <filterElements xmlns:xsi="http://www.w3.org/2001/XMLSchema-instance" xsi:type="rectFilterElement">
      <filterElementName>OAX.WFO</filterElementName>
      <!-- Filter that includes all observations within the Omaha Valley WFO -->
      <filterType>INCLUDE</filterType>
      <upperLeftLat>48</upperLeftLat>
      <upperLeftLon>-90</upperLeftLon>
      <lowerRightLat>40.0</lowerRightLat>
      <lowerRightLon>-80.10</lowerRightLon>
    </filterElements>
    <filterName>OAX.MetarToShef2</filterName>
  </metarToShefRun>
</metarToShefFilter>

```

### X.3 Metar2shef Configuration File

A sample **metar.cfg** configuration file is repeated below. Note that although the first 6 lines are no longer used in AWIPS2, they must be retained for backward compatibility. Thus in AWIPS2, processing begins with line 7, the line specifying the Physical Element (PE) codes to be decoded.

Depending on the switches that are set by the **metar2shef\_options** token in the *Apps\_defaults* file, the segments following line 7 (**begin** and **end names**, **begin** and **end sm\_alias**, and **begin** and **end pc\_reset**) may be used to further filter the metars that are being ingested.

```

/tmp/queue/metar/in
/tmp/queue/metar/out
/tmp/queue/metar/err
+SAOOUT
-ERRORFILE
-SHEFPASS
TA UP SD UD US TX TN PPT PPQ PPH PPD PA TAIRZR TAIRZH TAIRZP
.begin_names
KP01
KP06
KIFP
KCGZ
.end_names
.begin_sm_alias
12123 ABCA3
12323 ABGA3
.end_sm_alias
.begin_pc_reset
CJR 55
.end_pc_reset

```

- line 7 -> SHEF PE code filter

This line allows the user to select which SHEF values are to be written to the output file. The decoder is able to decode many PE codes, but some, for example the altimeter, are unlikely to be used.

The codes must all be on one line, and there must be at least one space between SHEF codes. The line is NOT limited to 80-characters.

The valid PE codes and their descriptions follow:

HG	HGIRGZZ	Instantaneous river stage
PA	PAIRZZZ	Altimeter, Station Pressure
PC	PCIRZZZ	Precipitation Accumulator
PE	PEIRGZZ	3-hour pressure characteristic, 0 - 8
PDIR	PDIRGZZ	3-hour pressure tendency
PL	PLIRGZZ	Sea level pressure
PPQ	PPQRZZZ	Precipitation 6-hour
PPD	PPDRZZZ	Precipitation 24-hour
PPH	PPHRZZZ	Precipitation 1-hour
PPT	PPTRZZZ	Precipitation past 3 hours
PTIR	PTIRGZZ	Precipitation Type ( SHEF table 17)
RT	RTIRZZZ	Sunshine

SD	SDIRZZZ	Snow depth on ground
SDQ	SDQRZZZ	New snow depth in past 6 hours xx.x
SW	SWIRZZZ	Water Equivalent
TA	TAIRZZZ	Temperature Instantaneous
TAIRZZ	TAIRZZZ	Temperature Instantaneous
TAIRZY	TAIRZYZ	Max Temp past 12 hours
TAIRZP	TAIRZPZ	Min Temp past 12 hours
TAIRZR	TAIRZRZ	Max Temp past 6 hours
TAIRZH	TAIRZHZ	Min Temp past 6 hours
TD	TDIRZZZ	Dew Point
TN	TAIRZTZ	Temperature Min 24 hour
TX	TAIRZXX	Temperature Max 24 hour
US	USIRZZZ	Wind Speed
UD	UDIRZZZ	Wind Direction
UQ	UQIRZZZ	Speed/Direction sss.sddd
XV	XVIRGZZ	Prevailing Visibility
UG	UGIRZZZ	Peak Wind/Gust
UP	UPIRGZZ	Peak wind speed during the past hour
UR	URIRGZZ	Peak wind direction for the peak wind speed
UQ	UQIRZZZ	SSS.SDDD wind speed and direction together
XW	XWIRZZZ	Present Weather Synoptic Code
XC	XCIRZZZ	Cloud Cover in tenths

**Note:** Use the codes as given. For example: if you only wanted 24 HR MAX and MIN temps and 24 HR precipitation you would use 'TX TN PPD'

The following 3 segments may appear in any order, but are described here in the order they appear in the example above.

- **Optional Segment: name/id filter**

This is an optional filter that will tell the decoder to produce output only for these ids. Other IDs and associated output will be thrown out. The decoder will key off the EXACT phrases in the cfg file: **'begin\_names'** and **'end\_names'**.

The ids must be between the phrases, with one id per line. For four-character ids, all four characters must be specified. If the '-a' option, which strips off the leading 'k', is used in the **metar2shef\_options** token in the AWIPS2 *Apps\_defaults* file, then either three- or four-character ids may be specified here.

The '-g' switch must be set in the **metar2shef\_options** token in the AWIPS2 *Apps\_defaults* file to cause the decoder to filter using these ids.

- **Optional Segment: alias id table for sm reports**

This is an option that tells the decoder to turn on checking of an alias id table only for SM observations. The numerical id of an SM can be converted or 'aliased' to the id that exists in the table. The alias id table is read in through the cfg file.

The decoder will key off the EXACT phrases in the cfg file: **‘.begin\_sm\_alias’** and **‘.end\_sm\_alias’**.

The id and alias id pair must be entered between the phrases, with one pair per line. The numerical id is first, followed by the alias ID, for example:

```
12123 ABCA3
12323 ABDA3
```

- **Optional Segment: pc\_reset time**

AWOS gages typically report 3 times an hour (at H+15, H+35, and H+55). If there is precipitation, each ob will contain a P group, which represents the cumulative precipitation through that time period. The P group in the H+55 ob represents the hourly precipitation.

The metar2shef decoder interprets the P group as an hourly precip amount, regardless of the observed time. This can result in incorrect precipitation data getting into Hydroview, MPE, or Riverpro. Therefore the metar2shef decoder has been enhanced to assign variable durations for sub-hourly precip amounts.

A precip “reset” time can be defined on a location-by-location basis by adding them to the bottom of the metar.cfg file. The decoder will key off the EXACT phrases in the cfg file: **‘.begin\_pc\_reset’** and **‘.end\_pc\_reset’**, for example:

```
.begin_pc_reset
CJR 55
.end_pc_reset
```

Each line between the ‘begin’ and ‘end’ lines represents the reset time in minutes, mm, from the top of the hour for the location on that line. If the ‘mm’ value is 55, then P groups reported at H+55 will be shef-encoded as an hourly precip amount.

To cause the decoder to read the “reset” values and locations, the ‘-pct #’ argument must be added to the **metar2shef\_options** token in the *Apps\_defaults* file. (The ‘-pct #’ argument is a tolerance value, where the # represents the number of minutes around the reset time in which the decoder will consider values to represent an hourly amount. For example, if the reset time is 55, and the tolerance value is 3, then obs between H+52 and H+58 will be considered hourly amounts.)

#### ***X.4 The metar2shef\_options Token***

The METAR-to-SHEF process is controlled not only by a combination of XML filters and the contents of a configuration file, but also by options or switches. The terms ‘options’ and ‘switches’ are used interchangeably here to reference the arguments supplied to the Metar2shef decoder by the **metar2shef\_options** token in the *Apps\_defaults* file. The options and their meanings are:



- '-a' When set, this option will strip off the first character of the station id in a METAR message. For example, the id 'KPIT' in the original message will be changed to 'PIT' in the SHEF message. The default is not to change the station id.
- '-b' When present, the decoder will attempt to decode all observations in a particular file (known as a collective of observations). The observations in each file must be of the same type, e.g., all METAR, or all SM.
- '-e' When set, the decoder will NOT convert temperatures and dew points to English units. The default, when the switch is not present, is to convert to English units.
- '-g' When this switch is included on the command line, the decoder will read in a list of ids from the configuration file. SHEF output will only be produced for these ids. All other observations will be tossed out. The decoder keys off the phrases '.begin\_names' and '.end\_names'. The ids must be between the phrases, with one id per line. For four-character ids, all four characters must be specified. If the '-a' option, which strips off the leading 'k', is used in the command line, then either three- or four-character ids may be specified.
- '-kt' When present, all values of wind speeds will be in knots. If the switch is not present (which is the default) wind speeds will be in miles/hour.
- '-l' When -l is set, it allows the user to distinguish the type of report, i.e., manual or automated (ASOS). With this switch set, the type/source of the SHEF PEDTSEP will be 'RO' and stand for ASOS type reports, and 'RV' will stand for manual reports. For example, precipitation from an ASOS site would be coded as PCIROZZ and precipitation from a non-automated site would be coded as PCIRVZZ. The default, if -l is not present, is to set the type/source to RZ, e.g., PCIRZZZ.
- '-m' When this switch is set, the decoder will assume the observation is a Canadian SAO, and that the data is in Metric units. Do not use this option when decoding U.S. SAOs or METAR observations.
- '-nospeci' Do not decode special observations. No special observations will be decoded if this switch is included. This applies to METAR as well as SAO observations. For METAR observations, all hourly observations will be decoded, even if they meet special criteria. For SAO observations, RS (Record Specials) will be decoded since they are on the hour.
- '-p1' This option will generate a zero report for automated rain gage sites if no value is reported and there is no PNO (Precipitation Not Operating) token. The value will be associated with a PPH. Remember that an automated rain gage is indicated

when either an A01 or A02 is detected in the report. If the PNO is detected a report value of 'M' will be generated.

- '-p6' If the -p6 switch is on, the following will occur:
- (a) if a precipitation value is indicated, it will be transmitted as given
  - (b) an 'M' will be sent if the observation indicates a missing value
  - (c) an 'M' will be sent if the observation is an automatic site and PNO is sent in the message,
  - (d) a zero amount of precipitation will be sent if the site is an automatic site, PNO is not present, and no value is transmitted in the observation.
- '-pall6' If the -pall6 switch is on, the following will occur:
- (a) if a precipitation value is indicated, it will be transmitted as given
  - (b) an 'M' will be sent if the observation indicates a missing value
  - (c) a zero amount will be transmitted in all other cases
- '-p24' Same as -p6 but for 24-hour precipitation.
- '-pall24' Same as -pall6 but for 24-hour precipitation.
- '-p12z' Only decode 24-hour precipitation in the window 1140Z - 1310Z. The default is to decode 24-hour amounts for all observation times.
- '-pct #' tolerance in minutes for pc reset times (default=2) to allow variable durations for sub-hourly precip amounts. A precip “reset” time can be defined on a location-by-location basis by adding location ids and tolerance values to the bottom of the **metar.cfg** file, between **'begin\_pc\_reset'** and **'end\_pc\_reset'** lines. (Each line between the 'begin' and 'end' lines represents the reset time in minutes, mm, from the top of the hour for the location on that line. If the mm value is 55, then P groups reported at H+55 will be shef-encoded as an hourly precip amount.) The '-pct #' argument is a tolerance value, where the # represents the number of minutes around the reset time in which the decoder will consider values to represent an hourly amount. For example, if the reset time is 55, and the tolerance value is 3, then obs between H+52 and H+58 will be considered hourly amounts.
- 'q1' This switch tells the decoder to output wind direction in hundreds (default is tens).
- '-round' This switch tells the decoder to round the observation to the nearest top of the hour. This switch will only apply to routine or non-SPECI observations. Routine or non-special observations are detected if:
- (1) the specification METAR is located at the beginning of the observation,

(2) no METAR or SPECI is detected in the observation. (If the specification 'SPECI' is detected, the observation is a special. All special observations are required to have the specification 'SPECI' in the observation.)

Examples: With the *'-round'* switch on:

0255Z rounds to 0300Z

2345Z rounds to 0000Z

0010Z rounds to 0000Z

When no *'-round'* switch is found, the time will be specified as it is in the observation (default).

- '-salias' This switch tells the decoder to turn on checking of alias id table for sm observations. The numerical id of an SM can be converted or 'aliased' to the corresponding id that exists in the table. The alias id table is read in through the cfg file. A sample of how to include the sm alias id table in the **metar.cfg** file is shown in *Appendix X.3*.
- '-strip' This switch tells the decoder to strip off potentially 'bad' ASCII codes that may have been put into the observation from other sources. These sources could be local data managers, the SBN from AWIPS, etc. The character values are not actually stripped off but converted to blanks. When the switch is not set (which is the default) all characters are passed 'as is'.
- '-sw' This switch tells the decoder to output 'V' for the source code located in the PEDTSEP instead of 'Z'. This will only occur for METAR-type observations, and will have no effect on SAO/SM. This option will allow a user to store and identify the observation as a METAR observation. SAOs for the same station will be stored with a 'Z'. For example, the PEDTSEP for a PPQ received from a METAR with the '-s' switch would be, PPQRVZZ. This should make it easy to identify the observations and make comparisons, etc.
- '-v' The verbose option writes to the **edex-ingest-yyyymmdd.log** up to 35 lines of SHEF-derived data created by the MetarToShefTransformer from the current metar file. This option is useful in testing and debugging.
- '-y2k' This switch will tell the decoder to output the 4-digit century/year in the SHEF output. The default is to output the 2-digit year.

## **Appendix Y**

### **Configuring the NetCDF Grid Decoder**

## Configuring the NetCDF Grid Decoder

On startup, the NetCDF Grid Decoder scans for XML Product Descriptions localization files located under `grid/netcdf/` and loads them. The Decoder will then match each ingested NetCDF grid file to at most one of these Product Descriptions, and decode the file based on the configuration.

Each Product Descriptions file must specify:

1. A single *pattern* tag specifying a regular expression that is used to match the filenames that should be decoded using this Product Descriptions file.
2. A single *datasetId* tag which specifies the Dataset Id of all the grid records decoded using this Product Descriptions file.
3. A single *level* tag which describes how to decode the level information in the file. See the Level Description section for more details.
4. A single *dateTime* tag which describes how to decode the DateTime. See the DateTime Description section for more details.
5. A single *coverage* tag which describes how to decode the Grid Coverage. See the Grid Coverage Description section for more details.
6. One or more *description* tags which describe a NetCDF variable containing grid data to extract and the Parameter associated with the data. See the Product Description section for more information.

Many of these parts will have one or more Field Descriptions used to decode the value. In general, a field description is either a NetCDF variable, a NetCDF global attribute, or a value configured in the Product Descriptions file. If a NetCDF variable or global attribute is configured, the value will be extracted from the current NetCDF file being decoded. If a value is configured, then that value will be used for every NetCDF file decoded using that Product Descriptions file.

One GridRecord will be decoded at a time from the file for each Parameter/Level combination, i.e. If the NetCDF file contains 3 levels and we want to decode data for 2 parameters, we should expect 6 GridRecords to be decoded, provided that every parameter has data at every level. Each Grid Record decoded from a single file will have the same DatasetID, DateTime, and Grid Coverage.

### **Pattern**

The configured regular expression is matched against the incoming filename. Only the first matching Product Descriptions configuration will be used when decoding a single file.

Example:

```
<pattern>^ncom_relo_alaska.*</pattern>
```

### **Dataset ID**

The configured datasetId will be applied to every Grid Record decoded using the Product Descriptions file.

Example:

```
<datasetId>NCOM-ALASKA</datasetId>
```

### **Level Description**

The level description consists of three Field Descriptions, the Master Level, the level one value, and (optionally) the level two value.

To specify the Master Level, exactly one of three tags must be provided:

1. `<masterLevelVariable name="variableName" />`
2. `<masterLevelAttribute name="attributeValue" />`
3. `<masterLevelValue value="theValue" />`

To specify the Level One Value, exactly one of three tags must be provided:

1. `<levelOneValueVariable name="variableName" />`
2. `<levelOneValueAttribute name="attributeValue" />`
3. `<levelOneValueValue value="theValue" />`

To specify the Level Two Value, exactly one of three tags may be provided:

1. `<levelTwoValueVariable name="variableName" />`
2. `<levelTwoValueAttribute name="attributeValue" />`
3. `<levelTwoValueValue value="theValue" />`

Example:

```
<level>
  <masterLevelValue value="BSS" />
  <levelOneValueVariable name="depth" />
</level>
```

## DataTime Description

The DateTime description consists of two parts, the reftime description and the forecast description.

The reftime must be specified in one of two ways: a field containing a formatted datetime or a field containing an offset from a known epoch.

For a formatted reftime, a Formatted RefTime Description is used. This specifies the dateFormat and a Field Description for the value. This is configured using a *formattedRefTime* tag.

For a reftime that is an offset from an epoch, an Epoch Offset RefTime Description is used. This specifies the epoch (in `YYYY-MM-dd HH:mm:ss` format), the unit of the offset (e.g. days, hours, seconds, etc), and the Field Description of the value. This is configured using an *epochOffsetRefTime* tag.

The forecast description specifies the units of the forecast (e.g. hours, seconds, etc) and the Field Description of the value. This is configured using a *forecast* tag.

The Field Description for the reftime and forecast descriptions must be specified in one of three ways:

1. `<variable name="theVariable" />`
2. `<attribute name="theAttribute" />`
3. `<value value="theValue" />`

### Examples:

```
<dateTime>
  <formattedRefTime dateFormat="yyyy-MM-dd HH:mm:ss">
    <attribute name="time_origin" />
  </formattedRefTime>
  <forecast units="HOURS">
    <variable name="tau" />
  </forecast>
</dateTime>

<dateTime>
  <epochOffsetRefTime epoch="1970-01-01 00:00:00" units="DAYS">
    <attribute name="pass_date" />
  </epochOffsetRefTime>
</dateTime>
```

### Grid Coverage Description

The Grid Coverage Description consists of a Grid Coverage specifying at a minimum the projection and (optional) descriptions to complete coverage information. The Grid Coverage can be configured inline or can be in a separate localization file. Currently, the only supported non-coverage description is the Coordinate Lists Description.

The Coordinate Lists Description consists of a Latitude Field Description and a Longitude Field Description. The latitude and longitude fields are required to be ordered lists with a consistent spacing. Using this, the `nx`, `ny`, `dx`, `dy`, `la1`, `lo1`, `firstGridPointCorner`, and `spacingUnit` fields are set. This is configured using the `coordinateLists` tag.



The Field Description for the Latitude description must be specified in one of two ways:

1. `<latitudeVariable name="theVariable" />`
2. `<latitudeAttribute name="theAttribute" />`

The Field Description for the Longitude description must be specified in one of two ways:

1. `<longitudeVariable name="theVariable" />`
2. `<longitudeAttribute name="theAttribute" />`

### Examples:

```
<coverage>
  <latLonGridCoverage />
  <coordinateLists>
    <latitudeVariable name="lat" />
    <longitudeVariable name="lon" />
  </coordinateLists>
</coverage>
```

```
<coverage coverageFile="netcdf/grids/5km_world.xml" />
```

```
<coverage>
  <latLonGridCoverage>
    <la1>89.975</la1>
    <lo1>-179.975</lo1>
    <nx>7200</nx>
    <ny>3600</ny>
    <dx>0.05</dx>
    <dy>0.05</dy>
    <firstGridPointCorner>UpperLeft</firstGridPointCorner>
    <spacingUnit>degree</spacingUnit>
  </latLonGridCoverage>
</coverage>
```

### Product Descriptions

A Product Description consist of exactly four parts, all of which are required:

1. a *data* tag specifying the name of the NetCDF variable containing the data
2. a *parameter* tag specifying the parameter abbreviation
3. a *parameterName* tag specifying the parameter name

4. a *units* tag specifying the units of the data in the file

If the units of the data does not match the standard units for the parameter, the data will automatically be converted into the standard unit when stored.

Examples:

```
<description>
  <data name="water_temp" />
  <parameter>T</parameter>
  <parameterName>Temperature</parameterName>
  <units>C</units>
</description>

<description>
  <data name="salinity" />
  <parameter>SALIN</parameter>
  <parameterName>Practical Salinity</parameterName>
  <units>PSU</units>
</description>
```

## Example Product Descriptions file:

```
<netcdfGridProductDescriptions>
  <dateTime>
    <formattedRefTime dateFormat="yyyy-MM-dd HH:mm:ss">
      <attribute name="time_origin" />
    </formattedRefTime>
    <forecast units="HOURS">
      <variable name="tau" />
    </forecast>
  </dateTime>

  <level>
    <masterLevelValue value="BSS" />
    <levelOneValueVariable name="depth" />
  </level>

  <datasetId>NCOM-ALASKA</datasetId>

  <pattern>^ncom_relo_alaska.*</pattern>

  <coverage>
    <latLonGridCoverage />
    <coordinateLists>
      <latitudeVariable name="lat" />
      <longitudeVariable name="lon" />
    </coordinateLists>
  </coverage>

  <description>
    <data name="water_u" />
    <parameter>UOGRD</parameter>
    <parameterName>u-component of current</parameterName>
    <units>m/s</units>
  </description>

  <description>
    <data name="water_v" />
    <parameter>VOGRD</parameter>
    <parameterName>v-component of current</parameterName>
    <units>m/s</units>
  </description>

  <description>
    <data name="water_temp" />
    <parameter>T</parameter>
    <parameterName>Temperature</parameterName>
    <units>C</units>
  </description>

  <description>
    <data name="salinity" />
    <parameter>SALIN</parameter>
    <parameterName>Practical Salinity</parameterName>
    <units>PSU</units>
  </description>
</netcdfGridProductDescriptions>
```

**Appendix Z**  
**What's New in SMM OB16.2.2**

This edition of the AWIPS System Manager's Manual includes a number of additions and changes. The key changes, additions, deletions, enhancements, and corrections found in the manual are described in this appendix.

The purpose of this appendix is not to provide a detailed and comprehensive listing of every change made to this new release (such as corrections of typographical or grammatical errors). Rather, it describes those changes that have been made in an effort to accurately reflect the current state of AWIPS II.

The AWIPS Documentation Team would like to express its appreciation to SMM users who have contacted us with questions or suggestions. Without their input, we might not have been able to identify and change some of the items listed here. If you spot a potential error in this edition, please contact us at [nws.hq.awips.smm.um@noaa.gov](mailto:nws.hq.awips.smm.um@noaa.gov).

## Chapter 2, System Architecture

In *Section 2.5.3.1, AWIPS II: COTS Software and Freeware, Table 2.5.3.1-1 COTS Software and Freeware Used in AWIPS II*, has been updated to reflect the following COTS FOSS Request (CFR) in this release.

- Scipy 0.15.1, pytz-2015.4+, 1.1.7, Basemap 1.0.7, Jep 3.4, numpy 1.9.2, dateutil 2.4.2+, matplotlib 1.4.3+, PostgreSQL 9.3.9, python 2.7.10 and camel 2.14.3.

The examples of mount points for DX3/DX4, CPSBNs, AXs and LX1 for the WFOs have been updated.

## Chapter 4, Data Flow Overview

Several examples throughout these chapters have been updated with recent results from the test-bed to reflect the new log entries.

## Chapter 6, Ingest of NWSTG data

Several examples throughout these chapters have been updated with recent results from the test-bed to reflect the new log entries.

## Chapter 15, Localization

The following sections have been updated to reflect the options to download the shapefiles from VLab.

*15.5, Baseline Shapefiles, 15.6 Modifying Shapefiles + Areas, 15.7 How to Download Shapefile Data, 15.8 Load and Activate the New Data on AWIPS and 15.9 Downloading Local Shapefiles.*

*Section 15.10, National Data Management (NDM) Files*, has been updated to show how the NDM files can be downloaded from the NOAA Virtual Lab.

## Chapter 16, Customization

16.6.2, *Updating the afos2awips.txt file*, has been updated to reflect the VLab option.

A new section 16.7, *Grid Definition Changes*, has been added.

## Chapter 25, AWIPS II/EDEX Administration Guide

Examples have been updated throughout this chapter with recent results from the test-bed, which reflect changes identified in the chapters above.

## Chapter 32, Broadcast Message Handler

In Section 32.3.2.1, *Table 32.3.2.1-1: Summary of Event Types* has been updated to reflect the new categories.

Section 32.4.2, *Start the BMH System*, has been updated with the new instructions.

Section 32.4.4, *Practice Mode*, has been added.

Section 32.5, *Configuring the DAC*, has been updated. This section will only cover configuring the DAC after it has been connected to the network and powered on.

A new Section 32.6, *Broadcast Message Handler (BMH) Procedure Failover to Spare DAC*, has been added.

This section gives step by step instructions for diagnosing whether a DAC has failed, basic remedial actions, and how to use the BMH Failover procedure to move transmissions over to the spare DAC (every WFO has one).

## Appendix C, Directories for /awips2/edex/data and /data/fxa

Several entries under these directories have been updated to reflect the revised format of the data files.

## Appendix G, AWIPS Password Management Policy

The following note has been added.

Note: Please remember that it only covers passwords and does not address compliance with HSPD-12 authentication.

## Appendix I, Administrative Tips for Monitoring System Performance

Several examples used in this appendix have been updated with recent results from the test-bed.

## Appendix J, WarnGen Templates

### J.1 OB16.2.2 WarnGen Template Activation

Release OB16.2.2 delivers various mixed case WarnGen Template changes. Please refer to the AWIPS Software Installation Note 106, AWIPS Release 16.2.2, Section A.4.4, for details. After the OB16.2.2 install, WarnGen should be tested in workstation PRACTICE mode. Be sure to test a full warning lifecycle for each product. For example, complete the following for every WarnGen product issued at the office. Verify that all geographic processing and template formatting work correctly:

1. *Issue a new warning for several counties.*
2. *Issue a correction.*
3. *For hydrologic products, issue an extension in time.*
4. *Issue a follow-up statement partial cancellation (cancel one or more counties and continue the warning in other counties.)*
5. *Issue a follow-up statement continuation.*
6. *Issue a follow-up statement cancellation.*
7. *Issue follow-up statement expiration.*

## Appendix N: AWIPS National Datasets

As of December 22, 2015, the "National Datasets" (NDM) were removed from baseline so configuration updates could occur as often as needed. So this appendix will be removed starting with release 16.2.2.

## Appendix O, NWRWAVES

This has been replaced with the latest version that is available for AWIPS II.

## Appendix P, Diagnosing System Health

Several examples used in this appendix have been updated with recent results from the test-bed.

## Appendix W, WarnGen Urban Boundaries

*Section W.2, OB16.1.1 WarnGen Template Activation*, has been deleted.

### W.3 Shape File Installation has been updated.

A new *Appendix Y*, Configuring the NetCDF Grid Decoder, has been added.

A new *Appendix AA*, *Instructions to Ingest ARI for your Site*, has been added.

A new *Appendix BB*, *National Centers for Environmental Prediction (NCEP) AWIPS/NAWIPS Migration Documentation* has been added.

It includes the following.

National Centers for Environment Prediction (NCEP) Information  
NATIONAL CENTER HARDWARE PROFILE  
NATIONAL CENTERS AWIPS CONFIGURATION

NSBN Initial Installation and the following attachments and SOPs

Attachment B: NCF Standard Operating Procedures (SOPs)

NCF NSBN SOP 1: Restart NSBN AWIPS processes in OPERATIONAL MODE

NCF NSBN SOP2: Restart NSBN AWIPS processes in ARCHIVE-ONLY

NCF NSBN SOP3: Troubleshooting NSBN Ingest Issues